

US00D964331S

(12) **United States Design Patent** (10) **Patent No.:** **US D964,331 S**  
**Koo** (45) **Date of Patent:** **\*\* Sep. 20, 2022**

(54) **ROUTER**

FOREIGN PATENT DOCUMENTS

(71) Applicant: **Samsung Electronics Co., Ltd.**,  
Suwon-si (KR)

EM 001814328-0001 2/2011  
EM 003165331-0004 9/2016

(Continued)

(72) Inventor: **Hyungjun Koo**, Suwon-si (KR)

*Primary Examiner* — Bridget L Eland

(73) Assignee: **SAMSUNG ELECTRONICS CO., LTD.**, Suwon-si (KR)

(74) *Attorney, Agent, or Firm* — McAndrews Held & Malloy, Ltd.

(\*\*) Term: **15 Years**

(57) **CLAIM**

The ornamental design for a router, as shown and described.

(21) Appl. No.: **29/770,668**

**DESCRIPTION**

(22) Filed: **Feb. 15, 2021**

(30) **Foreign Application Priority Data**

Oct. 22, 2020 (KR) ..... 30-2020-0050584

(51) **LOC (13) Cl.** ..... **14-03**

(52) **U.S. Cl.**  
USPC ..... **D14/242**

(58) **Field of Classification Search**

USPC .... D14/240, 242, 357, 358, 140-140.9, 155,  
D14/125, 137, 139, 243, 348, 349, 351,  
D14/354, 355, 433, 435.1  
CPC ..... H04L 12/00; H03K 17/00; H04W 88/00;  
H04W 88/005; H04W 88/02; H04W  
88/08; H04W 88/085; H04W 88/10;  
H04W 88/12; H04W 88/14; H04B 1/38

See application file for complete search history.

(56) **References Cited**

U.S. PATENT DOCUMENTS

D292,914 S \* 11/1987 Moeller ..... D13/184  
D378,915 S \* 4/1997 Widmayer ..... D13/179  
D379,799 S \* 6/1997 Widmayer ..... D13/179  
D548,629 S 8/2007 Rhine et al.

(Continued)

FIG. 1 is a front perspective view of a router showing my new design;  
FIG. 2 is a front view thereof;  
FIG. 3 is a rear view thereof;  
FIG. 4 is a left side view thereof;  
FIG. 5 is a right side view thereof;  
FIG. 6 is a top view thereof; and  
FIG. 7 is a bottom view thereof.  
FIG. 8 is a rear perspective view thereof;  
FIG. 9 is an enlarged view of the portion 9 encircled in FIG. 1;  
FIG. 10 is an enlarged view of the portion 10 encircled in FIG. 1;  
FIG. 11 is an enlarged view of the portion 11 encircled in FIG. 3;  
FIG. 12 is an enlarged view of the portion 12 encircled in FIG. 6; and  
FIG. 13 is an enlarged view of the portion 13 encircled in FIG. 7.

The dashed broken lines in the figures illustrate portions of the router that form no part of the claimed design.

The dot-dash broken lines in the figures illustrate a boundary of the claimed design, and form no part of the claimed design.

The dot-dot-dash broken lines in the drawings encircling portions of the claimed design that are illustrated in enlargements form no part of the claimed design.

**1 Claim, 13 Drawing Sheets**

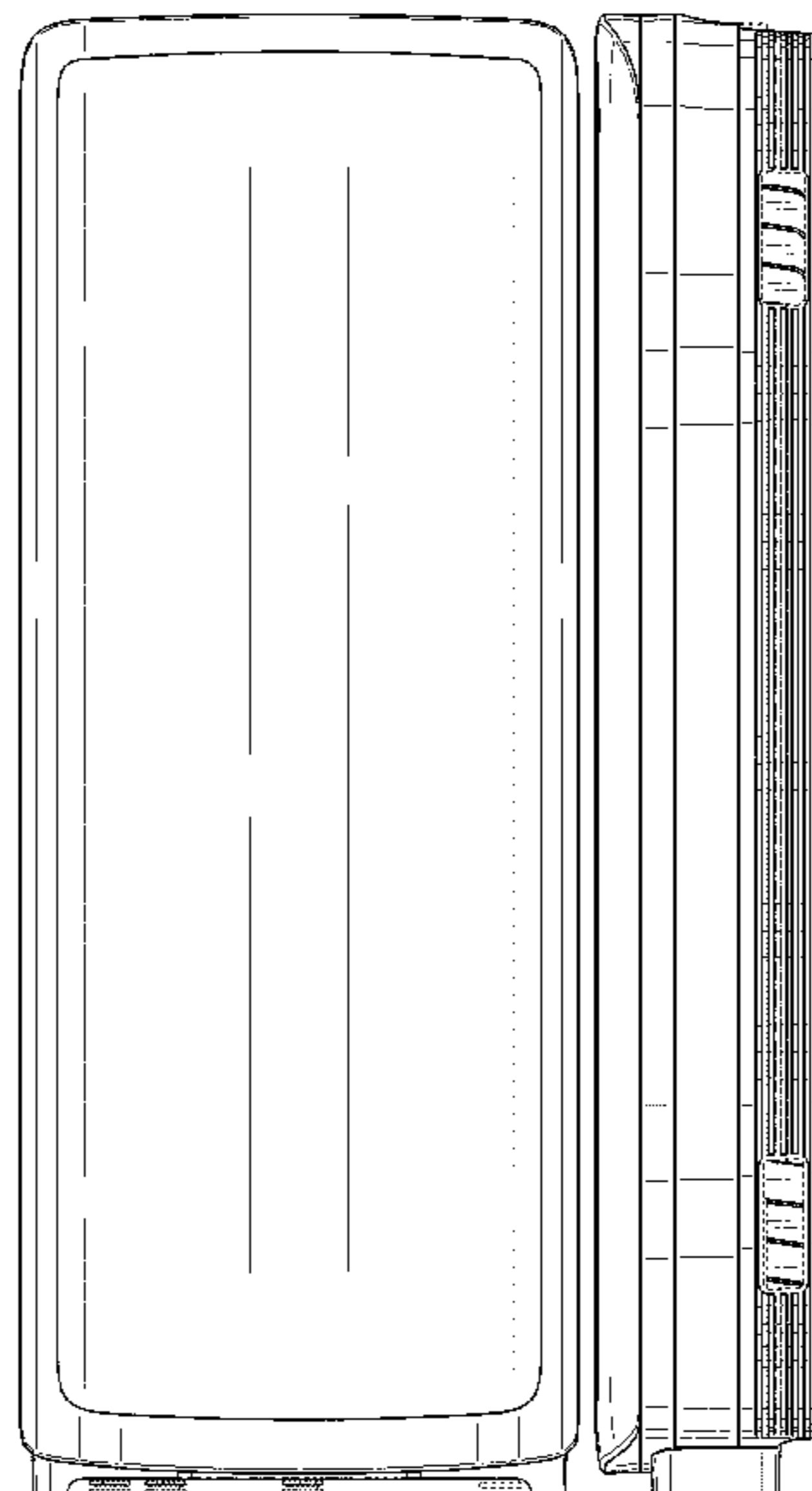

(56)

**References Cited**

U.S. PATENT DOCUMENTS

D693,798 S	11/2013	Chuang et al.	
D886,086 S *	6/2020	Jang .....	D14/240
D891,408 S *	7/2020	Kwak .....	D14/240
D891,409 S *	7/2020	Jeon .....	D14/240
D892,778 S *	8/2020	Jang .....	D14/240
D903,641 S *	12/2020	Moon .....	D14/240
D903,642 S *	12/2020	Moon .....	D14/242
D928,131 S *	8/2021	Jang .....	D14/242

FOREIGN PATENT DOCUMENTS

GB	8202809000-1000	*	8/2019
IN	320988-001-0001	*	8/2020
IN	347026-001-0001	*	9/2021
JP	D1684324	*	4/2021
JP	D1697807	*	10/2021
KR	30-0963911		7/2018
KR	301015901.0000	*	7/2019
KR	301015902.0000	*	7/2019
KR	301015903.0000	*	7/2019
KR	301088239.0000	*	12/2020
KR	301126931.0000	*	9/2021
KR	301126935.0000	*	9/2021
KR	301126936.0000	*	9/2021
KR	301126937.0000	*	9/2021
KR	301132243.0000	*	10/2021
KR	301132247.0000	*	10/2021
WO	D202809-001	*	3/2020
WO	D211477-002	*	5/2021
WO	D211477-004	*	5/2021

\* cited by examiner

FIG. 1

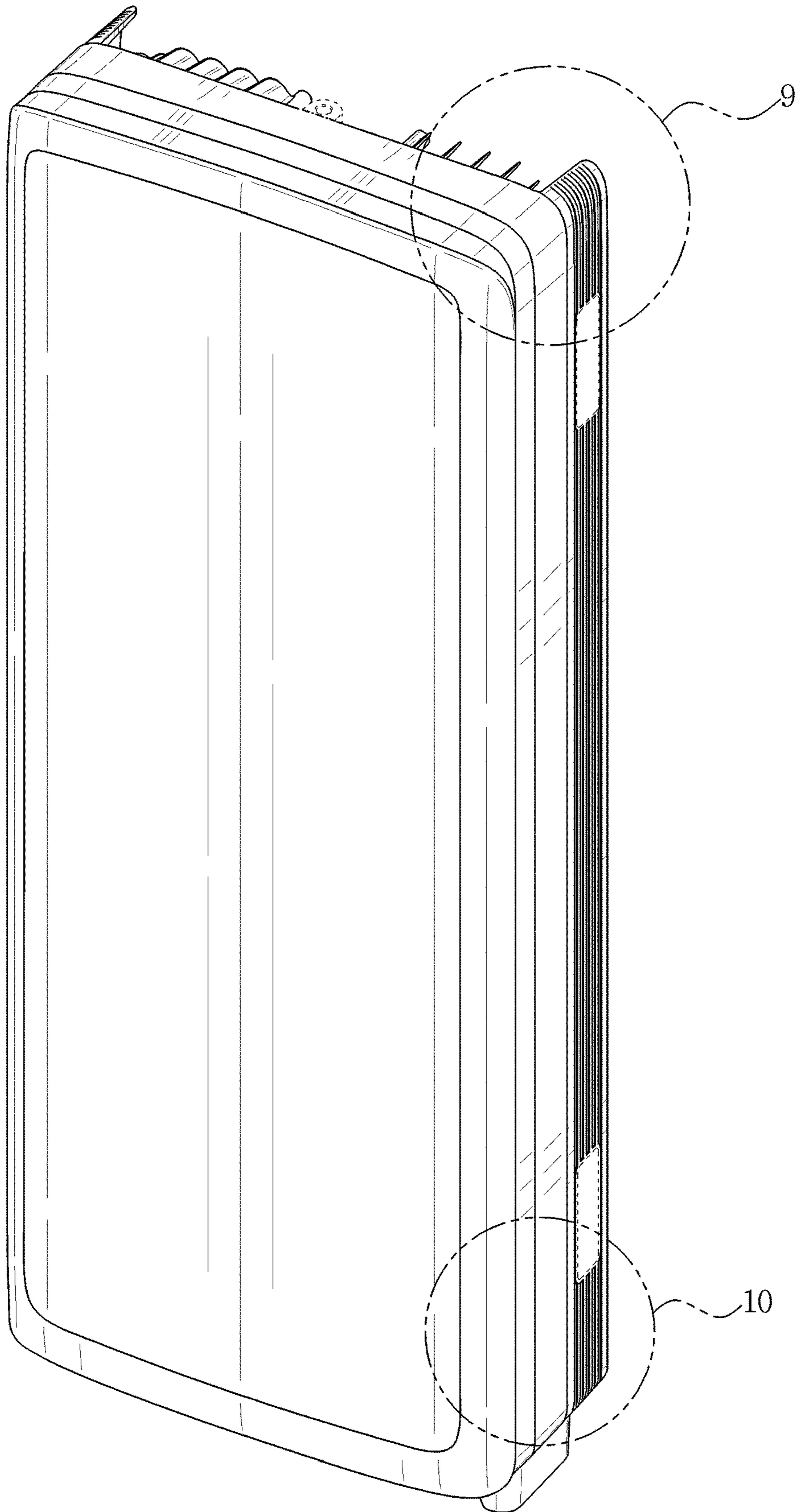

FIG. 2

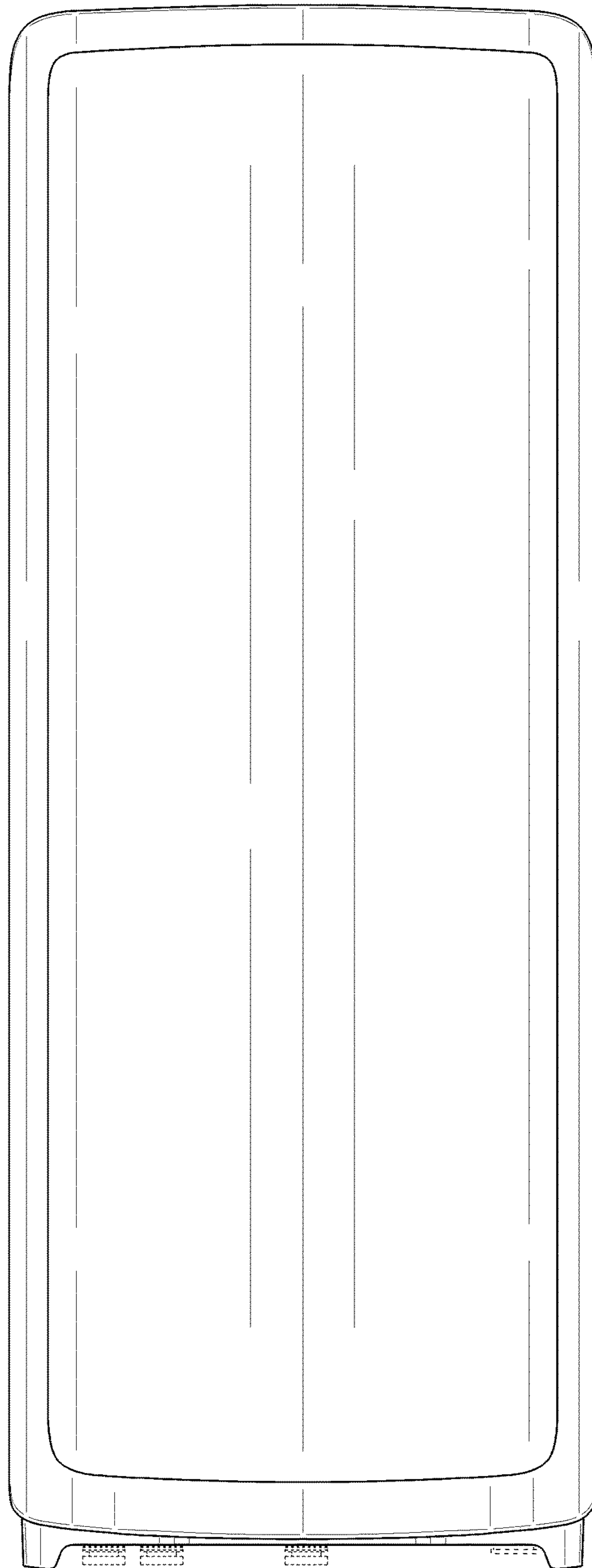

FIG. 3

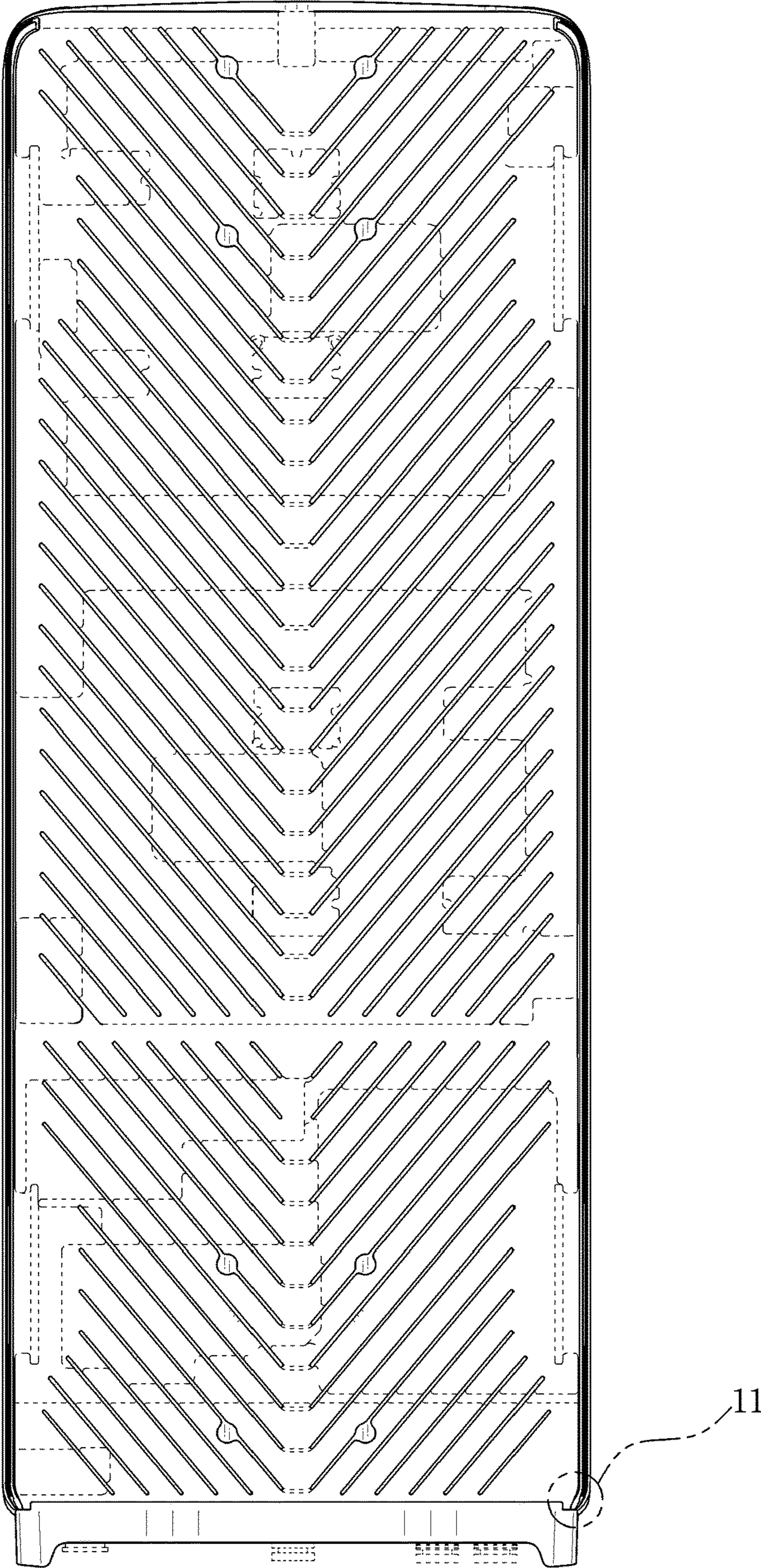

FIG. 4

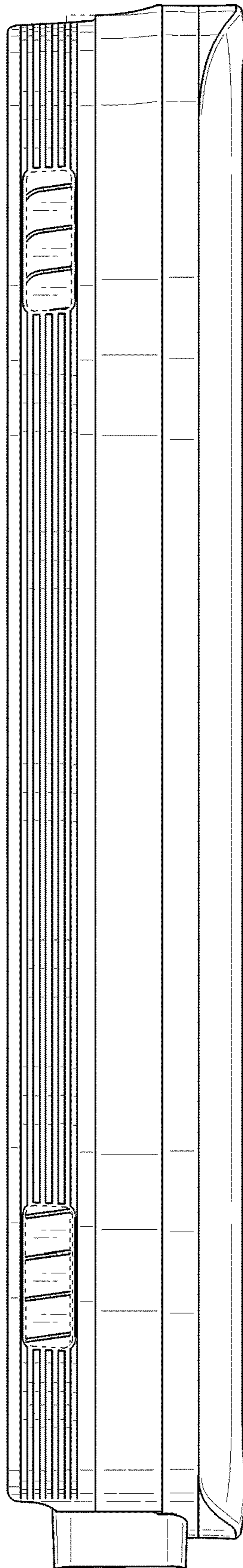

FIG. 5

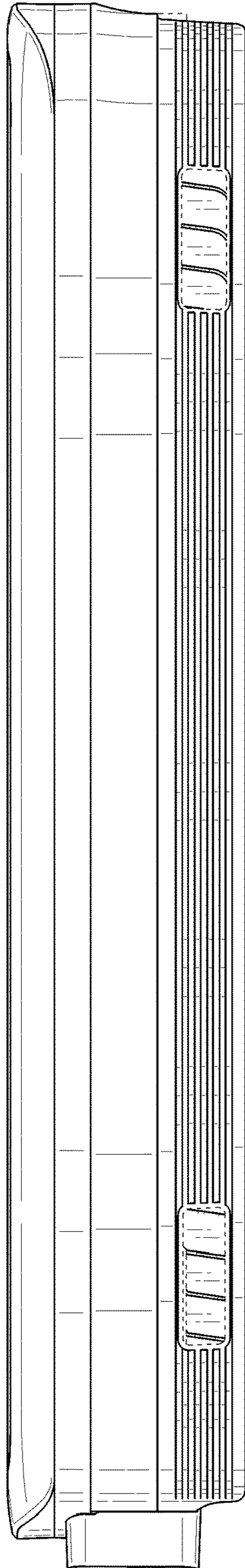

FIG. 6

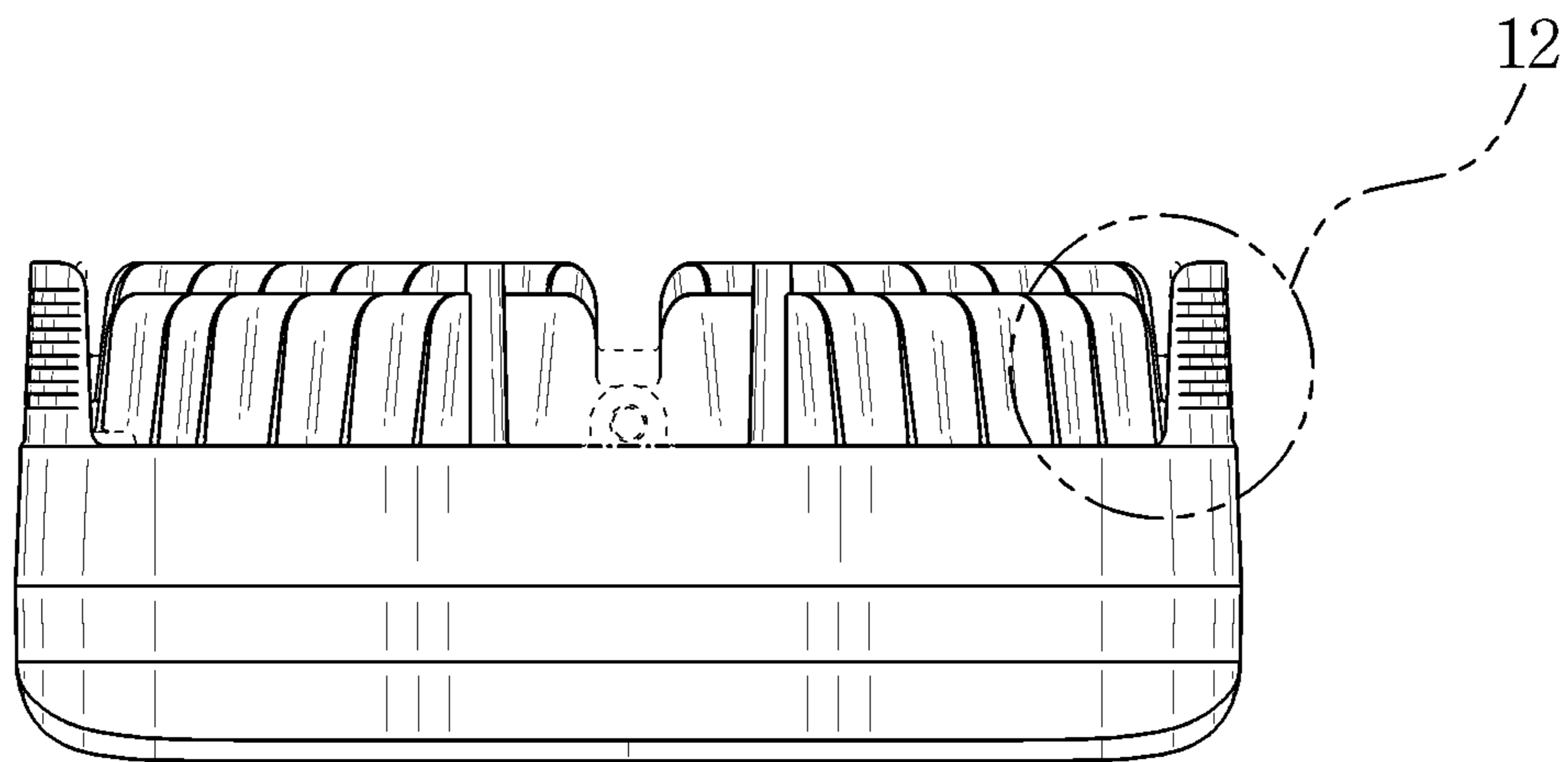



FIG. 7

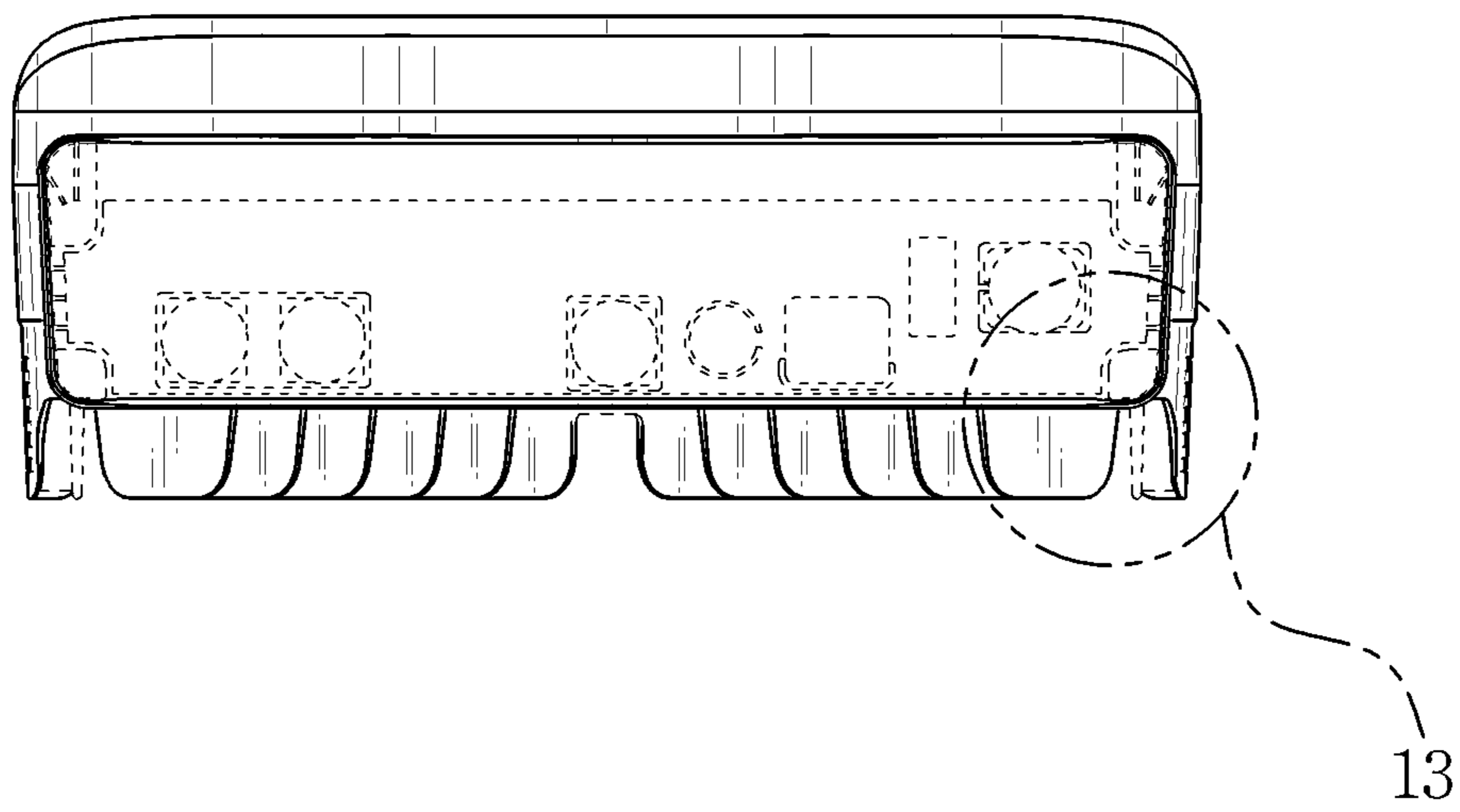

FIG. 8

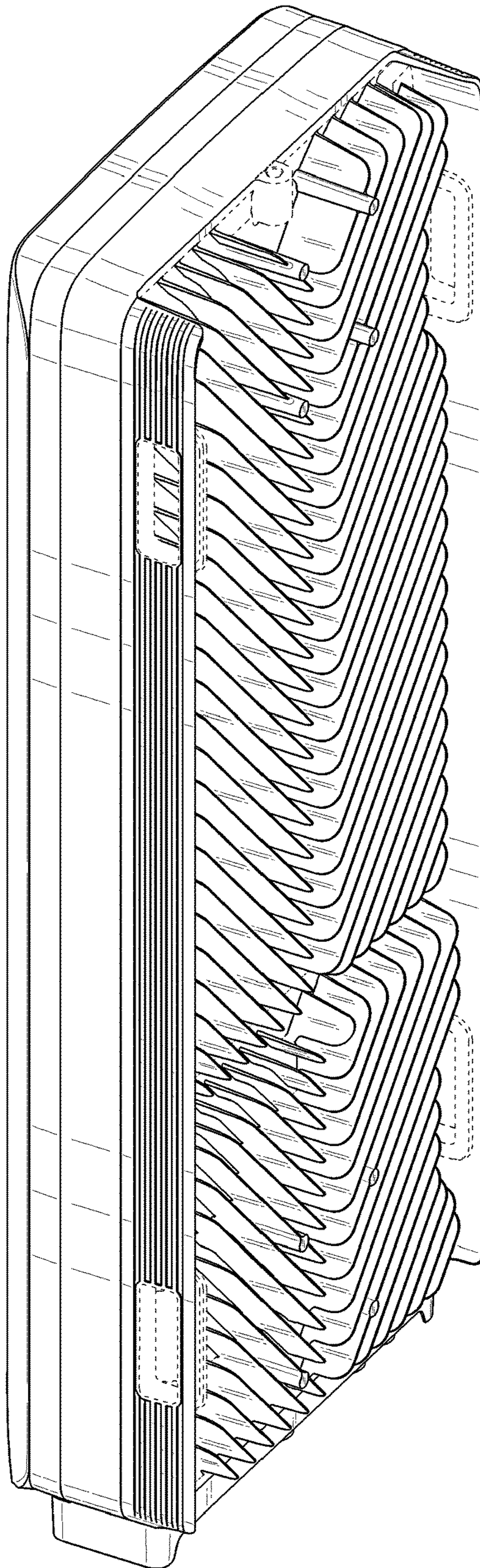

FIG. 9

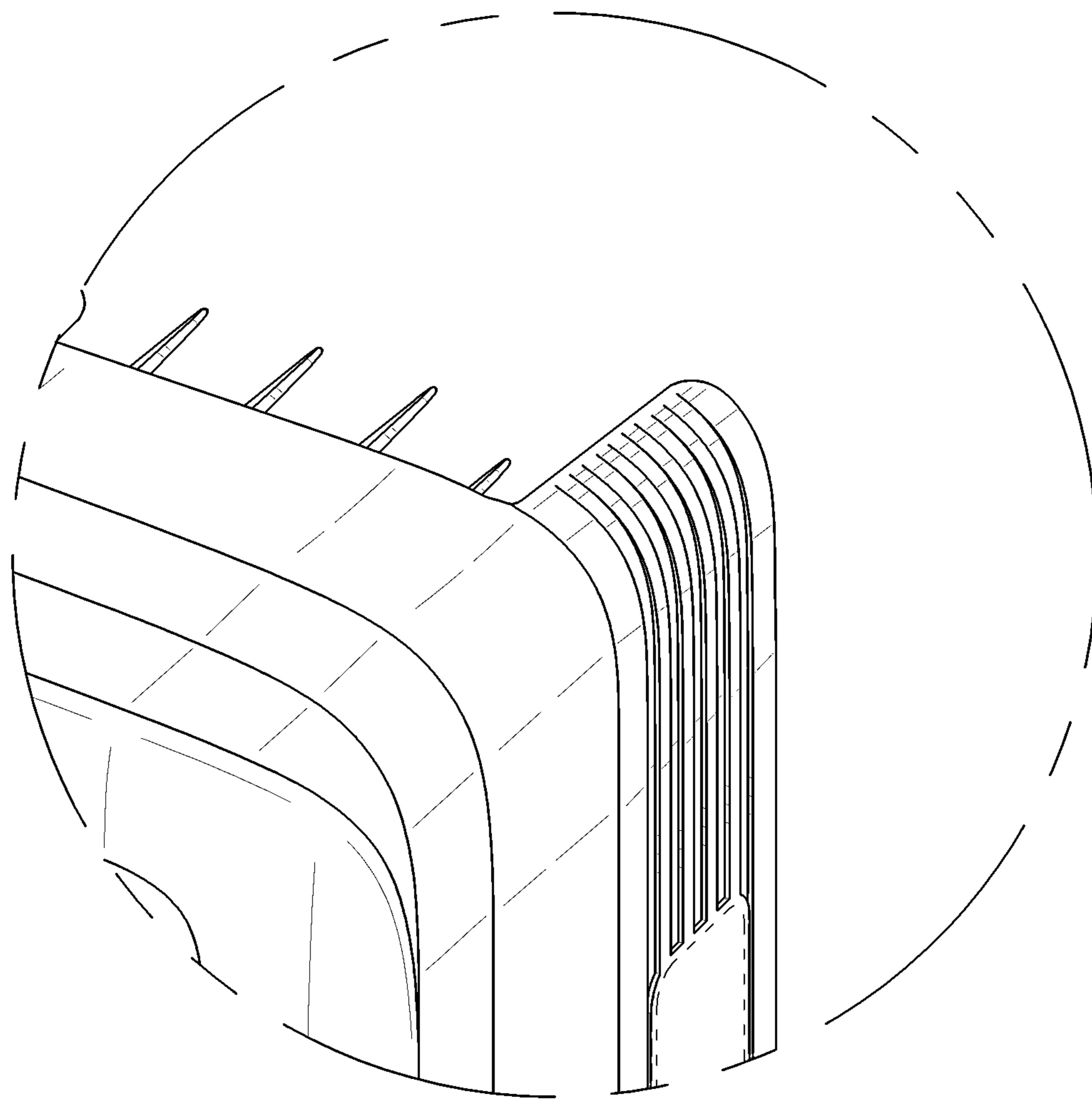

FIG. 10

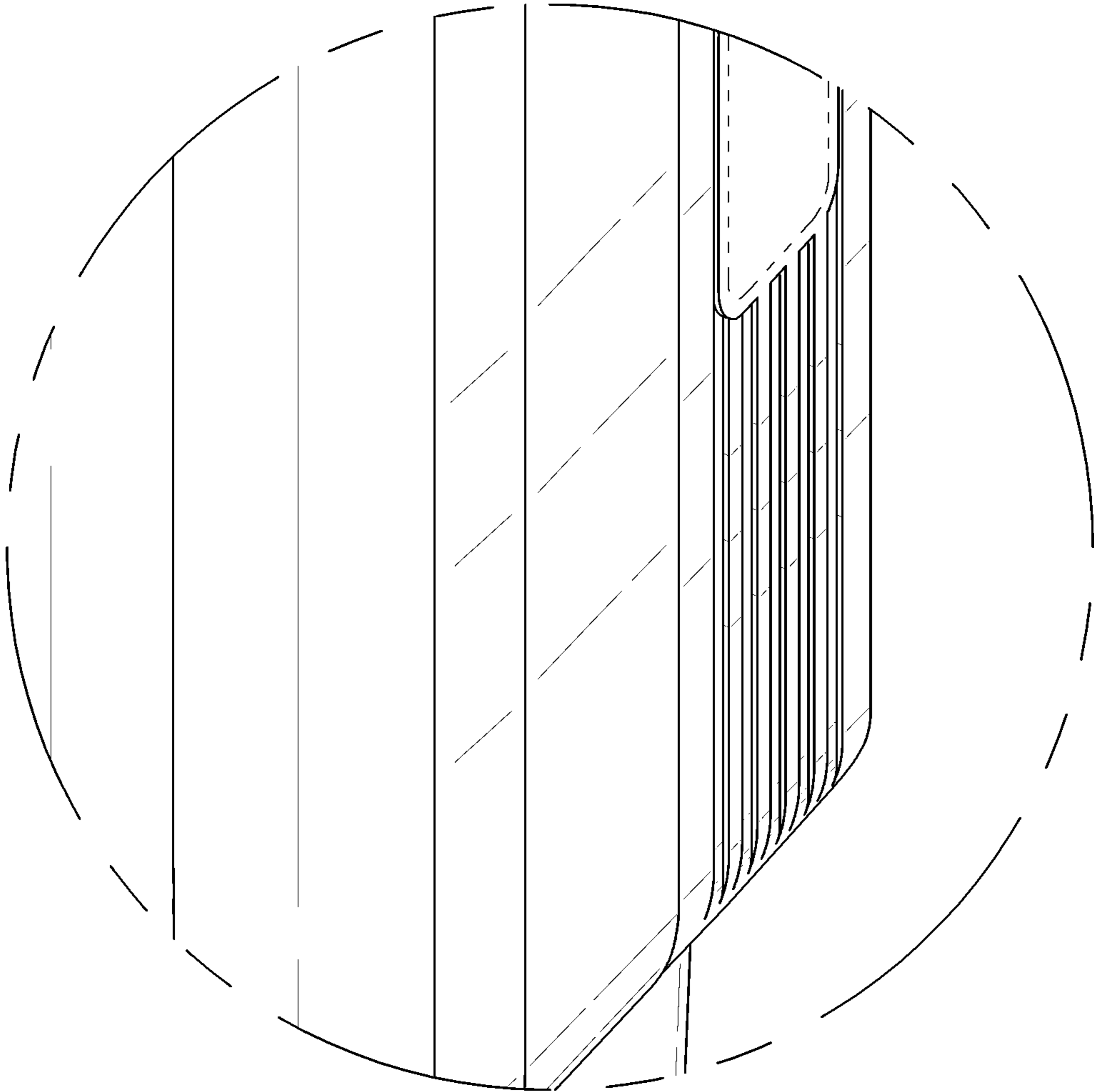

FIG. 11

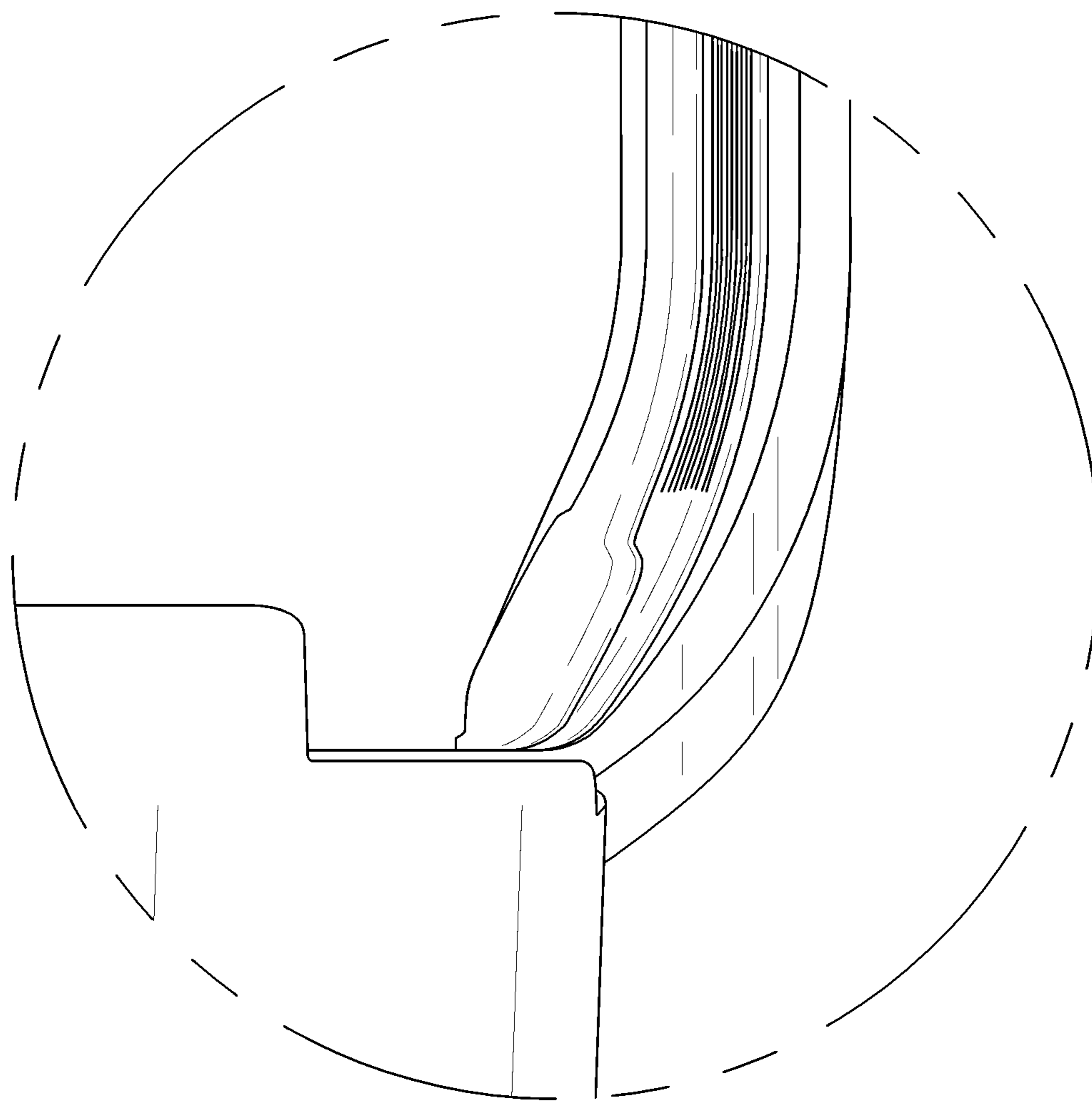

FIG. 12

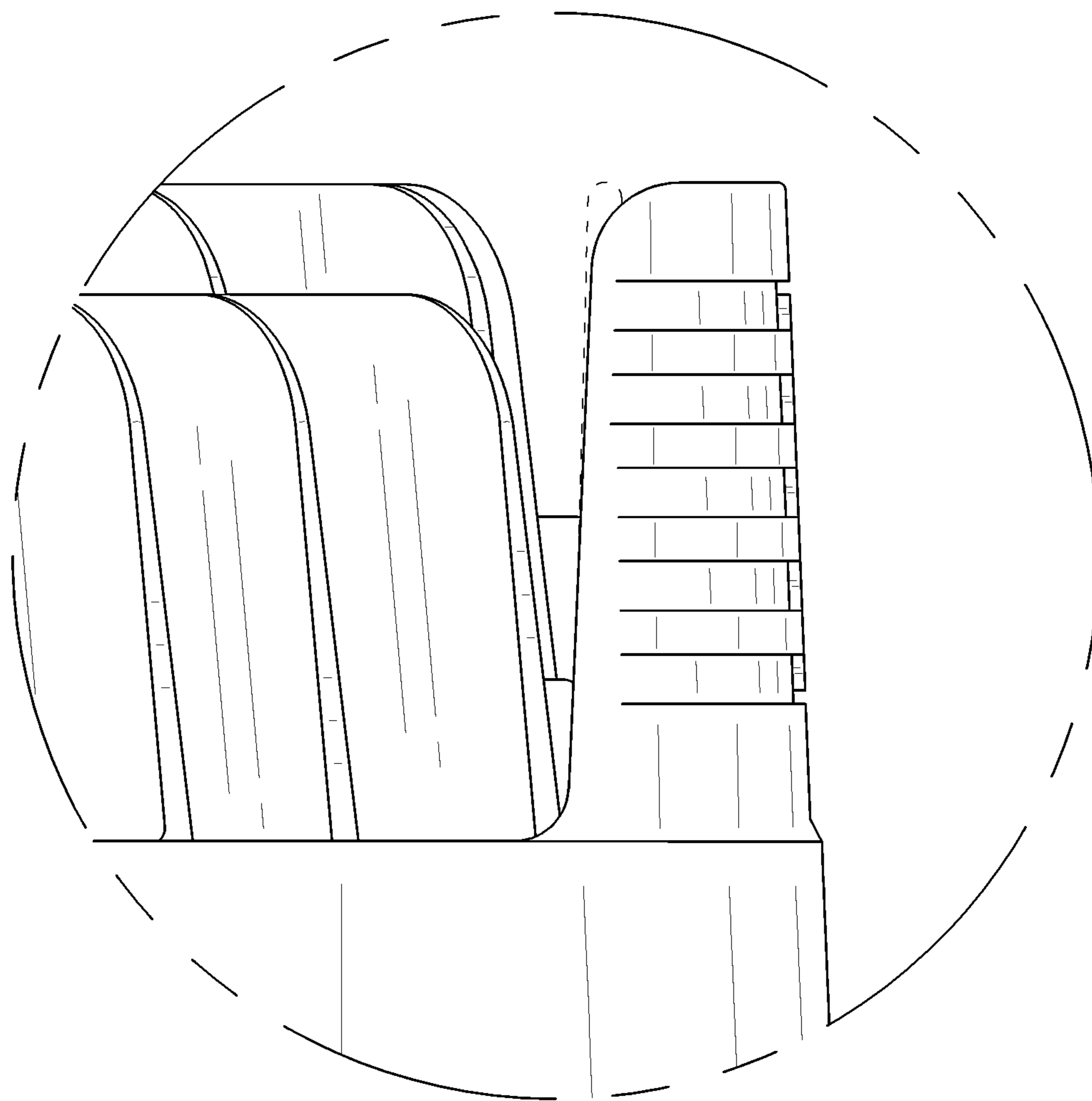

FIG. 13

