

US00D964306S

(12) **United States Design Patent**  
**Gong et al.**

(10) **Patent No.:** **US D964,306 S**  
(45) **Date of Patent:** **\*\* Sep. 20, 2022**

(54) **MOBILE PHONE**

(71) Applicant: **BEIJING XIAOMI MOBILE SOFTWARE CO., LTD.**, Beijing (CN)

(72) Inventors: **Shengyu Gong**, Beijing (CN); **Xu Wei**, Beijing (CN)

(73) Assignee: **BEIJING XIAOMI MOBILE SOFTWARE CO., LTD.**, Beijing (CN)

(\*\*) Term: **15 Years**

(21) Appl. No.: **29/753,239**

(22) Filed: **Sep. 30, 2020**

(30) **Foreign Application Priority Data**

Apr. 9, 2020 (CN) ..... 202030135751.0

(51) **LOC (13) Cl.** ..... **14-03**

(52) **U.S. Cl.**  
USPC ..... **D14/138 AB**

(58) **Field of Classification Search**  
USPC ..... D14/138 AA, 138 AB, 138 AC, 138 AD,  
D14/138 C, 138 R, 138 G, 214, 248, 250,  
D14/330, 341, 345-347, 426, 371  
(Continued)

(56) **References Cited**

**U.S. PATENT DOCUMENTS**

D345,356 S \* 3/1994 Ando ..... D14/138 AB  
D468,279 S \* 1/2003 Kim ..... D14/138 AB  
(Continued)

**OTHER PUBLICATIONS**

Samsung Galaxy Z Flip 5G—Full phone specifications, announced Jun. 22, 2020 [online], retrieved Mar. 10, 2022, available at URL: [https://www.gsmarena.com/samsung\\_galaxy\\_z\\_flip\\_5g-10244.php](https://www.gsmarena.com/samsung_galaxy_z_flip_5g-10244.php) (Year: 2020).\*

(Continued)

*Primary Examiner* — Wendy L Arminio

*Assistant Examiner* — Carrie S Gelula

(74) *Attorney, Agent, or Firm* — Amster, Rothstein & Ebenstein LLP

(57) **CLAIM**

The ornamental design for a mobile phone, as shown and described.

**DESCRIPTION**

FIG. 1 is a front view of a mobile phone, showing the new design;

FIG. 2 is a back view of the mobile phone;

FIG. 3 is a left view of the mobile phone;

FIG. 4 is a right view of the mobile phone;

FIG. 5 is a top view of the mobile phone;

FIG. 6 is a bottom view of the mobile phone;

FIG. 7 is a top right perspective view of the mobile phone;

FIG. 8 is a bottom left perspective view of the mobile phone;

FIG. 9 is a front view of the mobile phone in a folded and closed state;

FIG. 10 is a back view of the mobile phone in the folded and closed state;

FIG. 11 is a left view of the mobile phone in the folded and closed state;

FIG. 12 is a right view of the mobile phone in the folded and closed state;

FIG. 13 is a top view of the mobile phone in the folded and closed state;

FIG. 14 is a bottom view of the mobile phone in the folded and closed state;

FIG. 15 is a top right perspective view of the mobile phone in the folded and closed state;

FIG. 16 is a bottom left perspective view of the mobile phone in the folded and closed state;

FIG. 17 is a front view of the mobile phone in a partially folded and sitting state;

FIG. 18 is a back view of the mobile phone in the partially folded and sitting state;

FIG. 19 is a left view of the mobile phone in the partially folded and sitting state;

FIG. 20 is a right view of the mobile phone in the partially folded and sitting state;

(Continued)

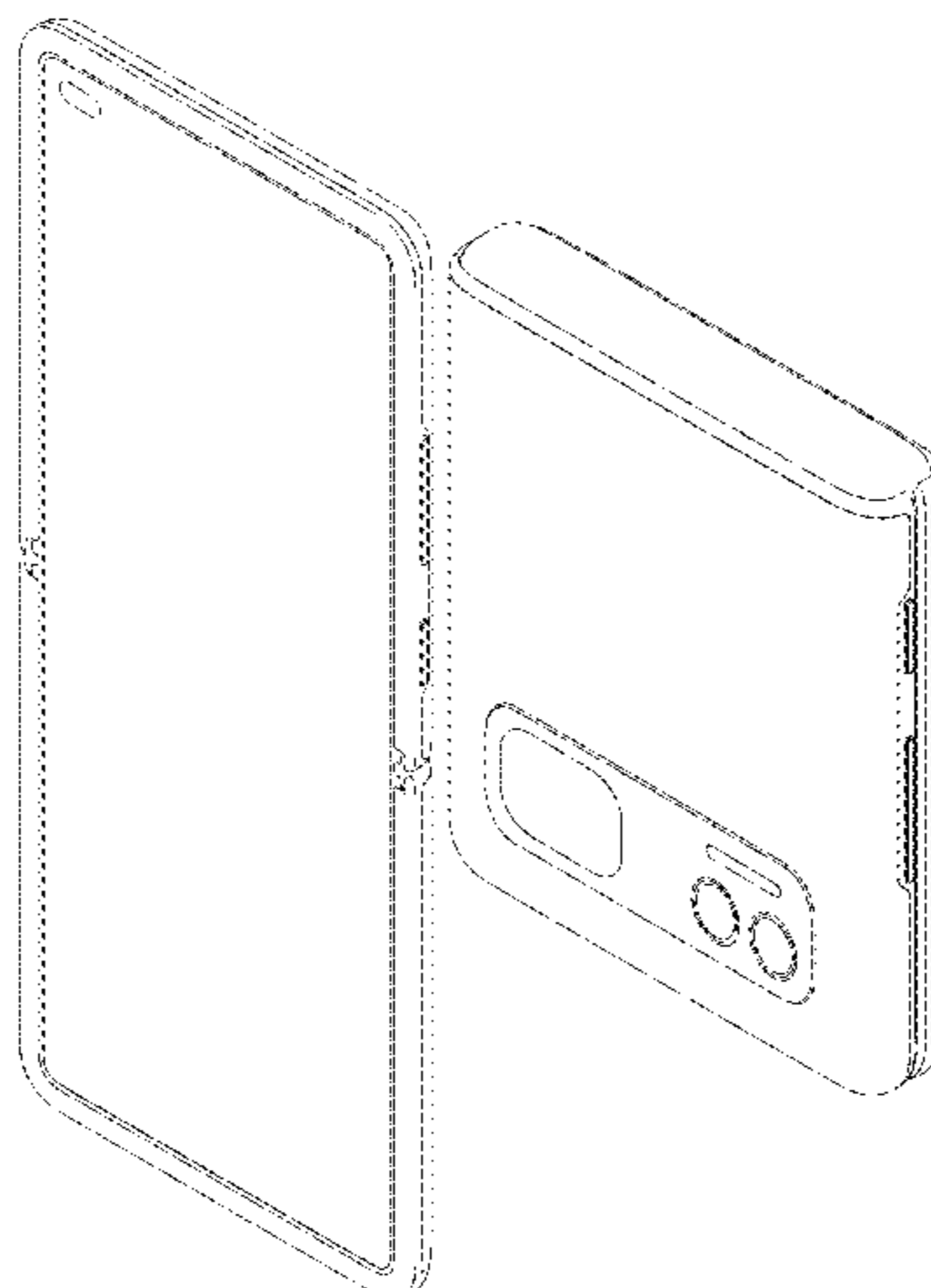


FIG. 21 is a top view of the mobile phone in the partially folded and sitting state;  
 FIG. 22 is a bottom view of the mobile phone in the partially folded and sitting state;  
 FIG. 23 is a top right perspective view of the mobile phone in the partially folded and sitting state; and,  
 FIG. 24 is a bottom left perspective view of the mobile phone in the partially folded and sitting state.

**1 Claim, 20 Drawing Sheets**

(58) **Field of Classification Search**

CPC ... G06F 1/1652; H04M 1/027; H04M 1/0202; H04M 1/0279; H04M 1/0235; H04M 1/0237; H04M 1/0239; H04M 1/0266; H04M 1/0268; H04M 1/0295

See application file for complete search history.

(56) **References Cited**

U.S. PATENT DOCUMENTS

D525,230 S \* 7/2006 Kim ..... D14/138 AB  
 D544,852 S \* 6/2007 Takamori ..... D14/138 AB  
 D571,345 S \* 6/2008 Kim ..... D14/138 AB  
 D573,127 S \* 7/2008 Choi ..... D14/138 AB  
 D584,268 S \* 1/2009 Kim ..... D14/138 AB

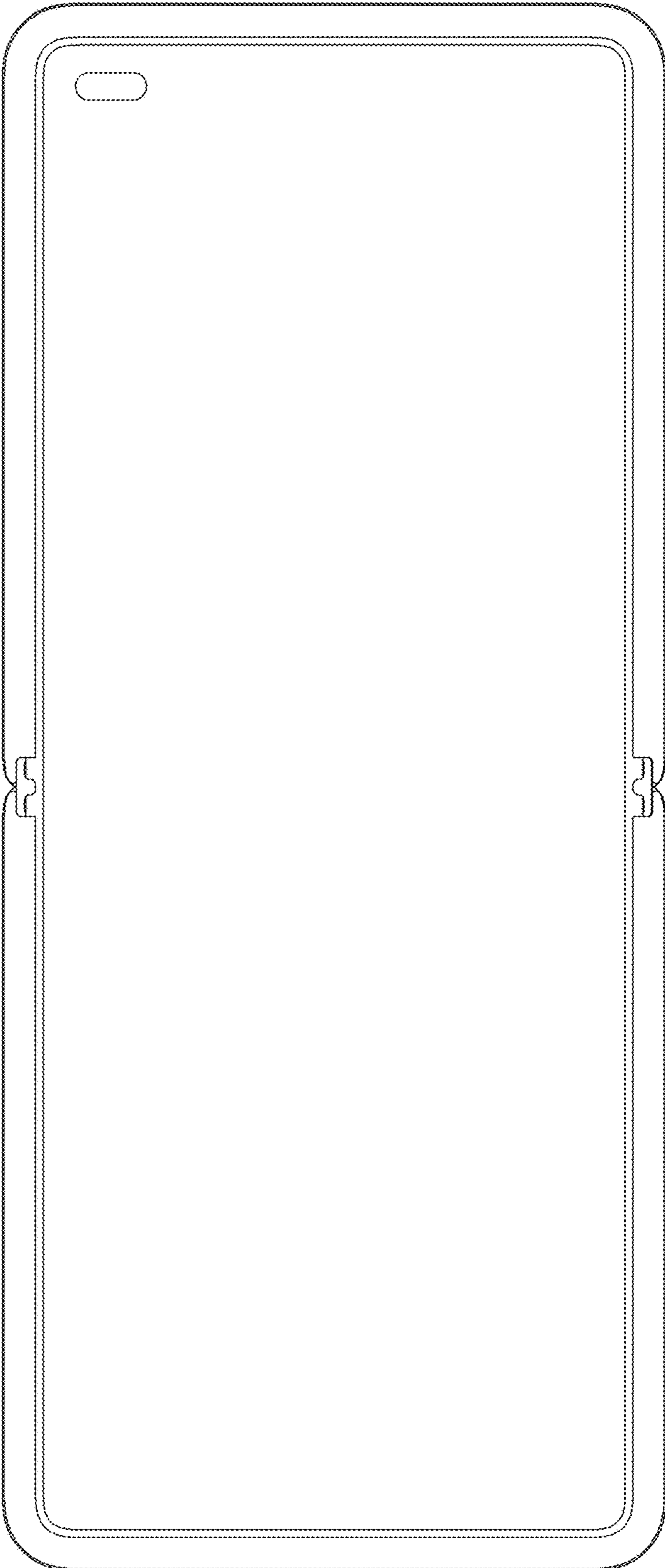
D585,409 S \* 1/2009 Kim ..... D14/138 AB  
 D590,807 S \* 4/2009 Kim ..... D14/138 AB  
 D607,430 S \* 1/2010 Song ..... D14/138 AB  
 D633,069 S \* 2/2011 Ryu ..... D14/138 AB  
 D905,670 S \* 12/2020 Seo ..... D14/248  
 D920,315 S \* 5/2021 Seo ..... D14/248  
 2018/0039387 A1 \* 2/2018 Cheong ..... H04M 1/0216  
 2018/0039408 A1 \* 2/2018 Cheong ..... G06F 3/0481  
 2018/0109871 A1 \* 4/2018 Huh ..... H05K 5/0217  
 2020/0409429 A1 \* 12/2020 Hsu ..... G06F 1/1616  
 2021/0067614 A1 \* 3/2021 Cheng ..... G06F 1/1681  
 2021/0247806 A1 \* 8/2021 Lee ..... G06F 1/1652  
 2021/0247815 A1 \* 8/2021 Shim ..... G06F 1/1681  
 2021/0248347 A1 \* 8/2021 Seo ..... G06F 1/1684  
 2021/0255665 A1 \* 8/2021 Yoo ..... G06F 1/1616  
 2021/0294383 A1 \* 9/2021 Kim ..... H04M 1/0268

OTHER PUBLICATIONS

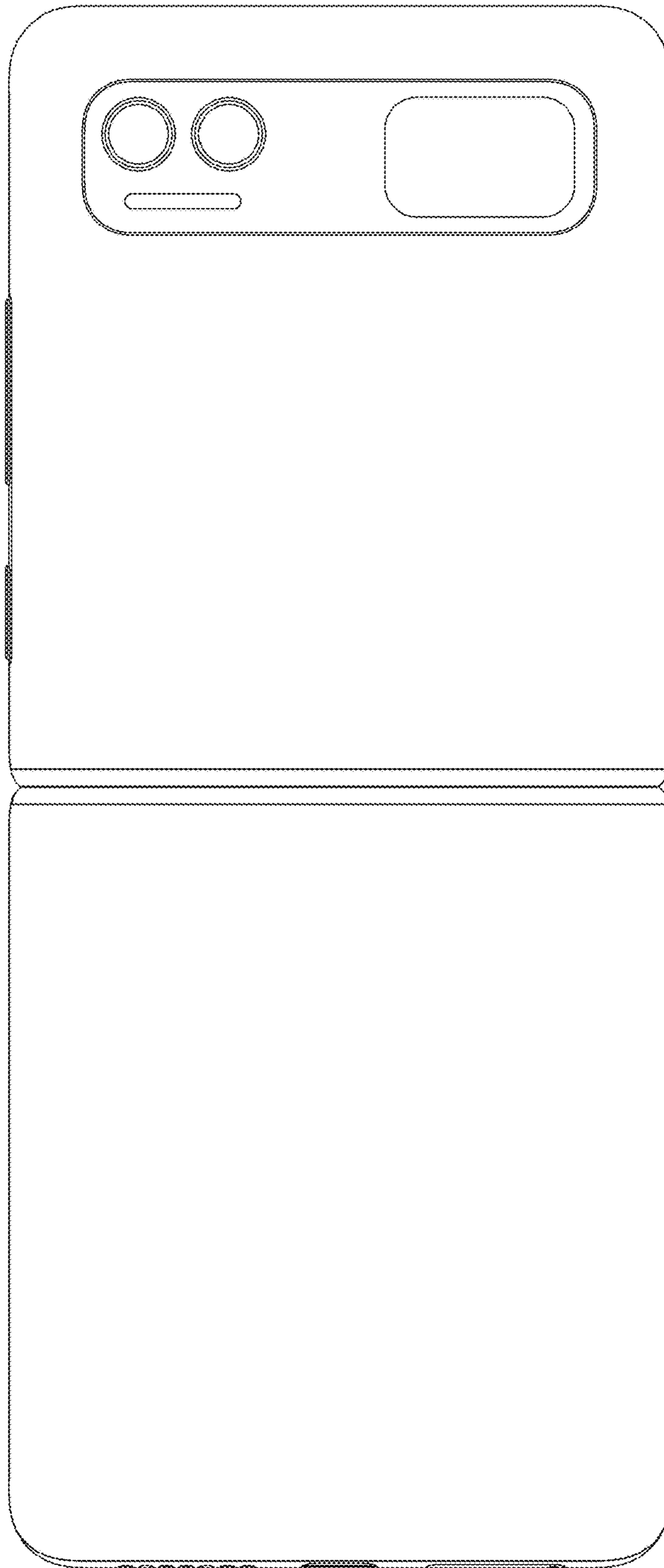
Dec. 23, 2021—Huawei P50 Pocket—Full phone specifications, announced Dec. 23, 2021 [online], retrieved Mar. 9, 2022, available at URL: [https://www.gsmarena.com/huawei\\_p50\\_pocket-11280.php](https://www.gsmarena.com/huawei_p50_pocket-11280.php) (Year: 2021).\*

Mar. 24, 2020—Xiaomi Mi Alpha Flip—Concept Phones, first available Mar. 24, 2020 [online], retrieved Apr. 4, 2022, available at URL: <https://www.concept-phones.com/xiaomi/xiaomi-mi-alpha-flip-is-finally-the-foldable-flip-phone-weve-been-waiting-for/> (Year: 2020).\*

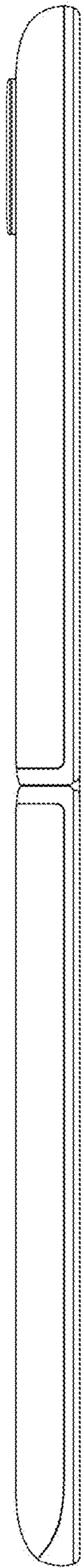
\* cited by examiner



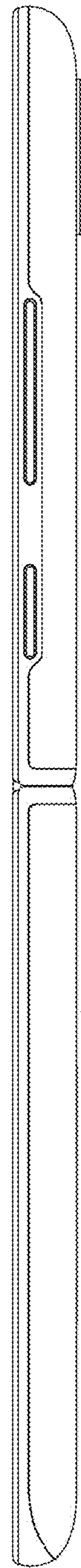
**FIG. 1**



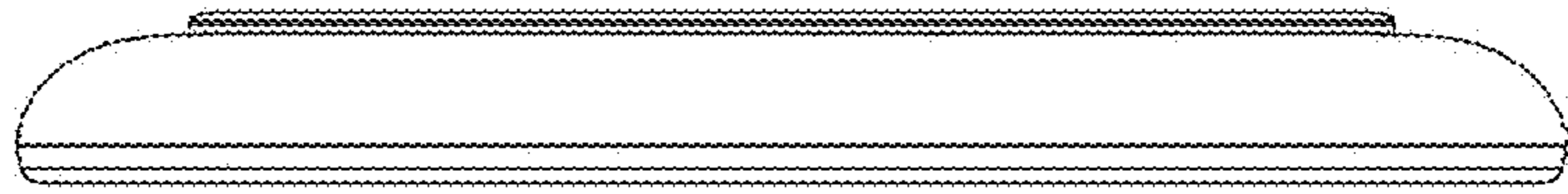
**FIG. 2**



**FIG. 3**



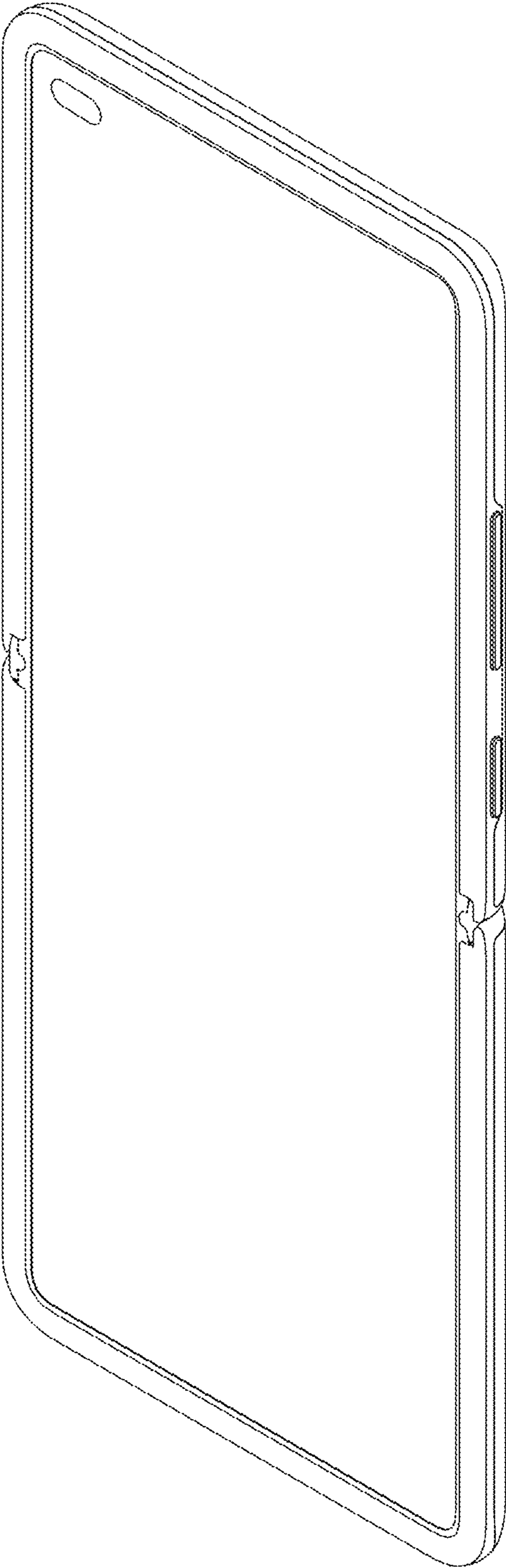
**FIG. 4**



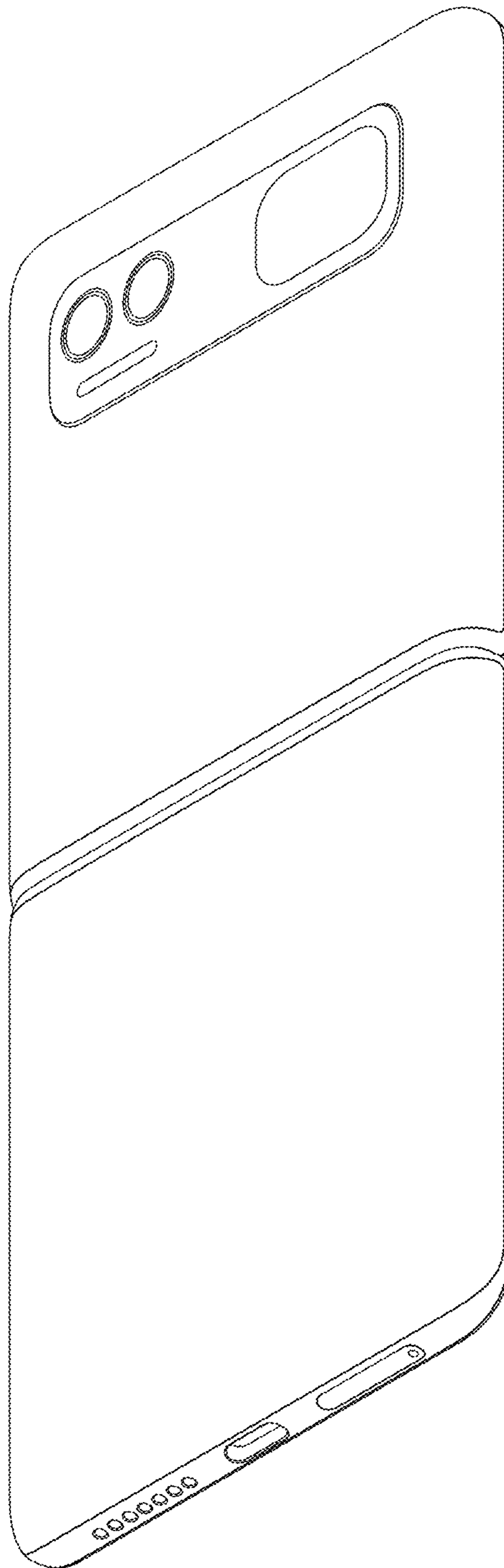
*FIG. 5*



*FIG. 6*

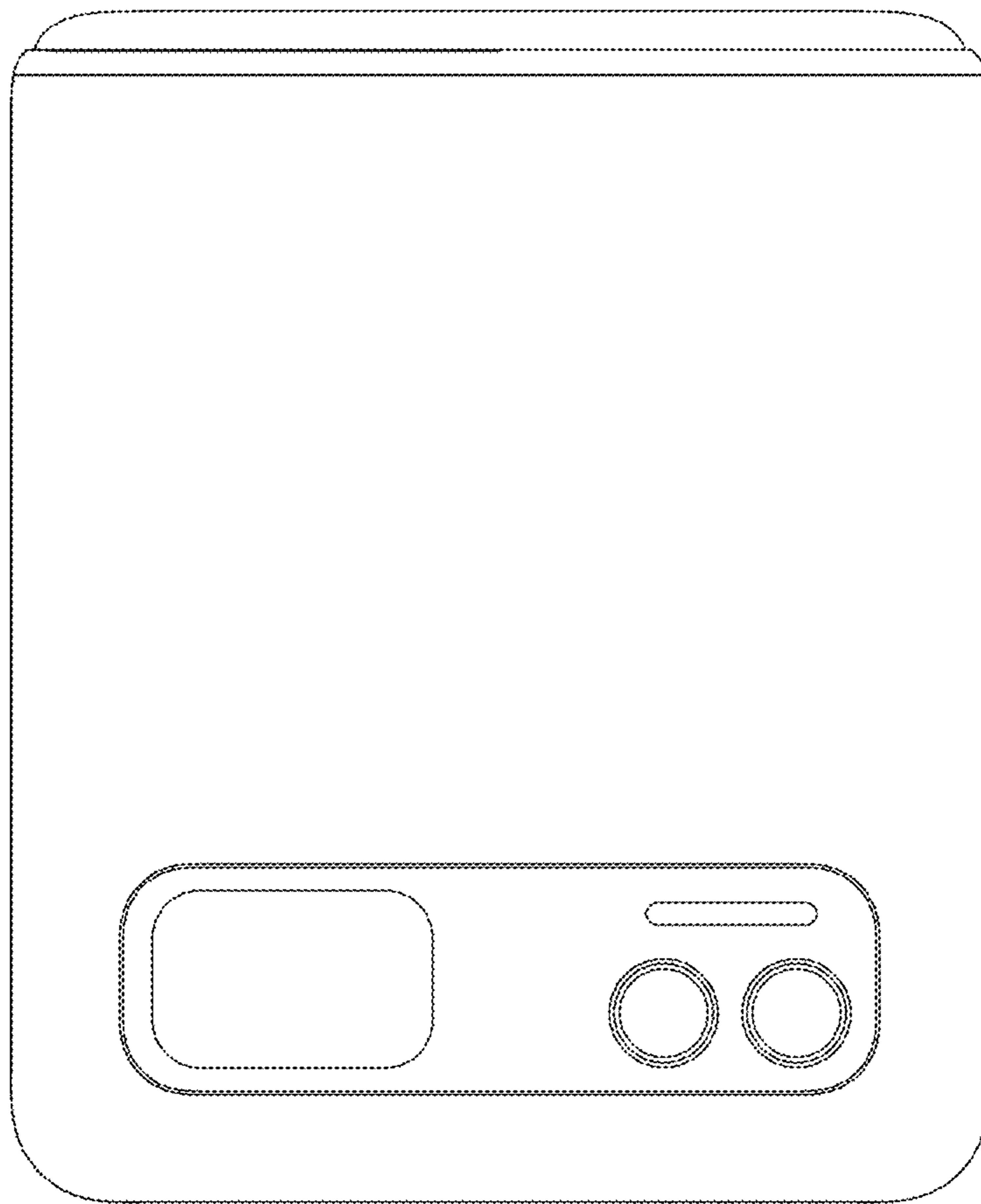


**FIG. 7**

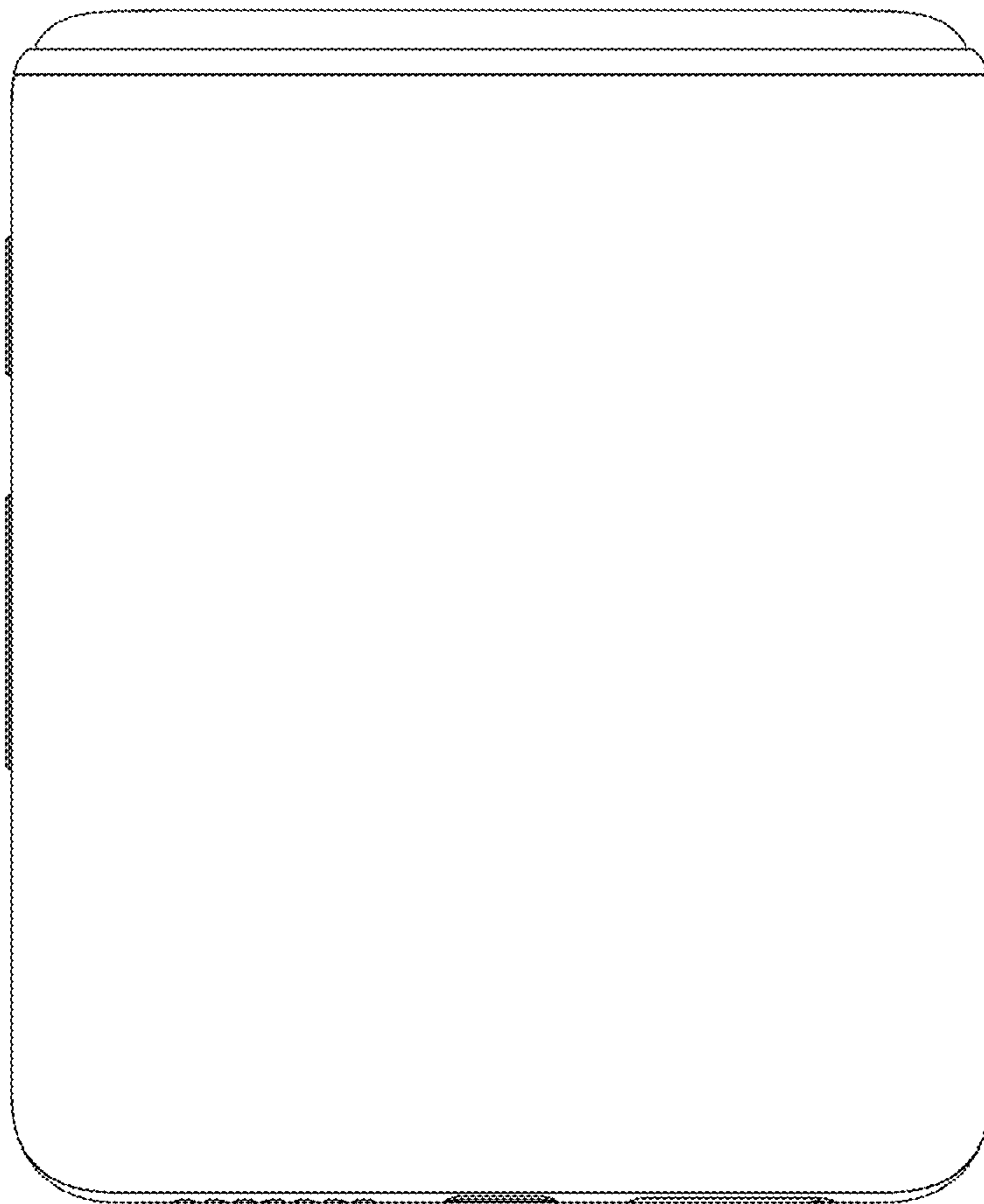


**FIG. 8**

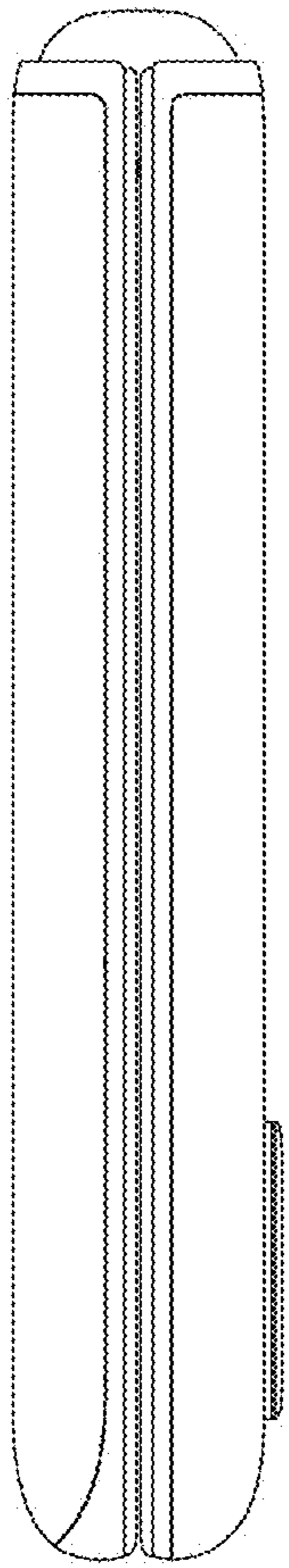




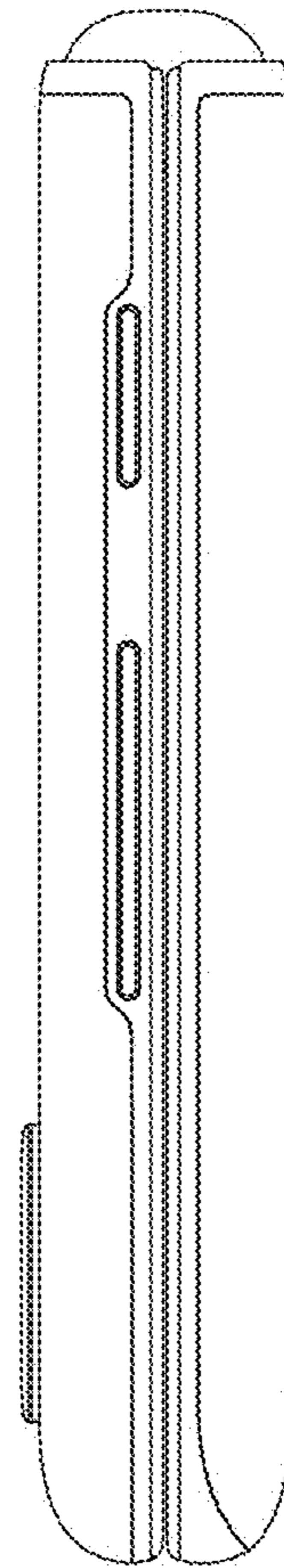
**FIG. 9**



***FIG. 10***



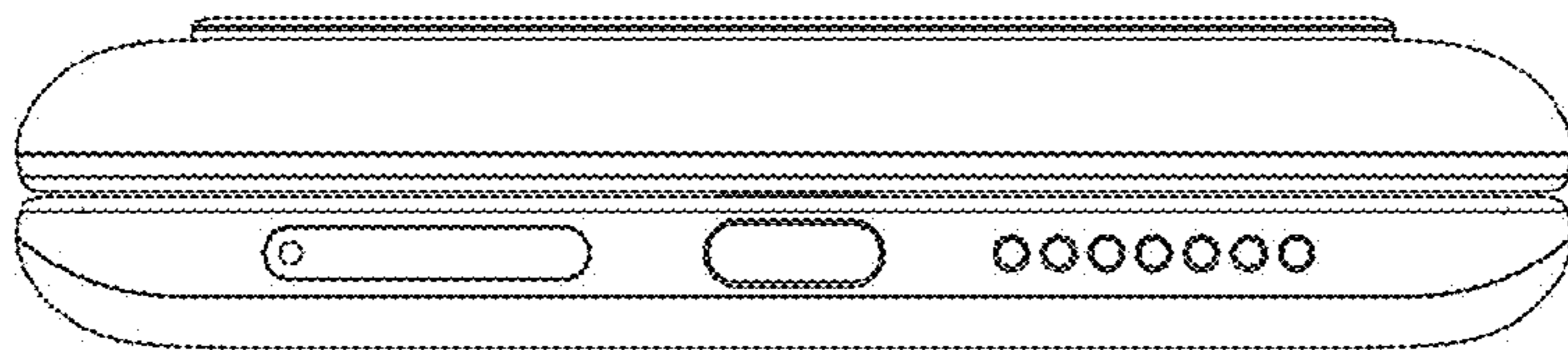
**FIG. 11**



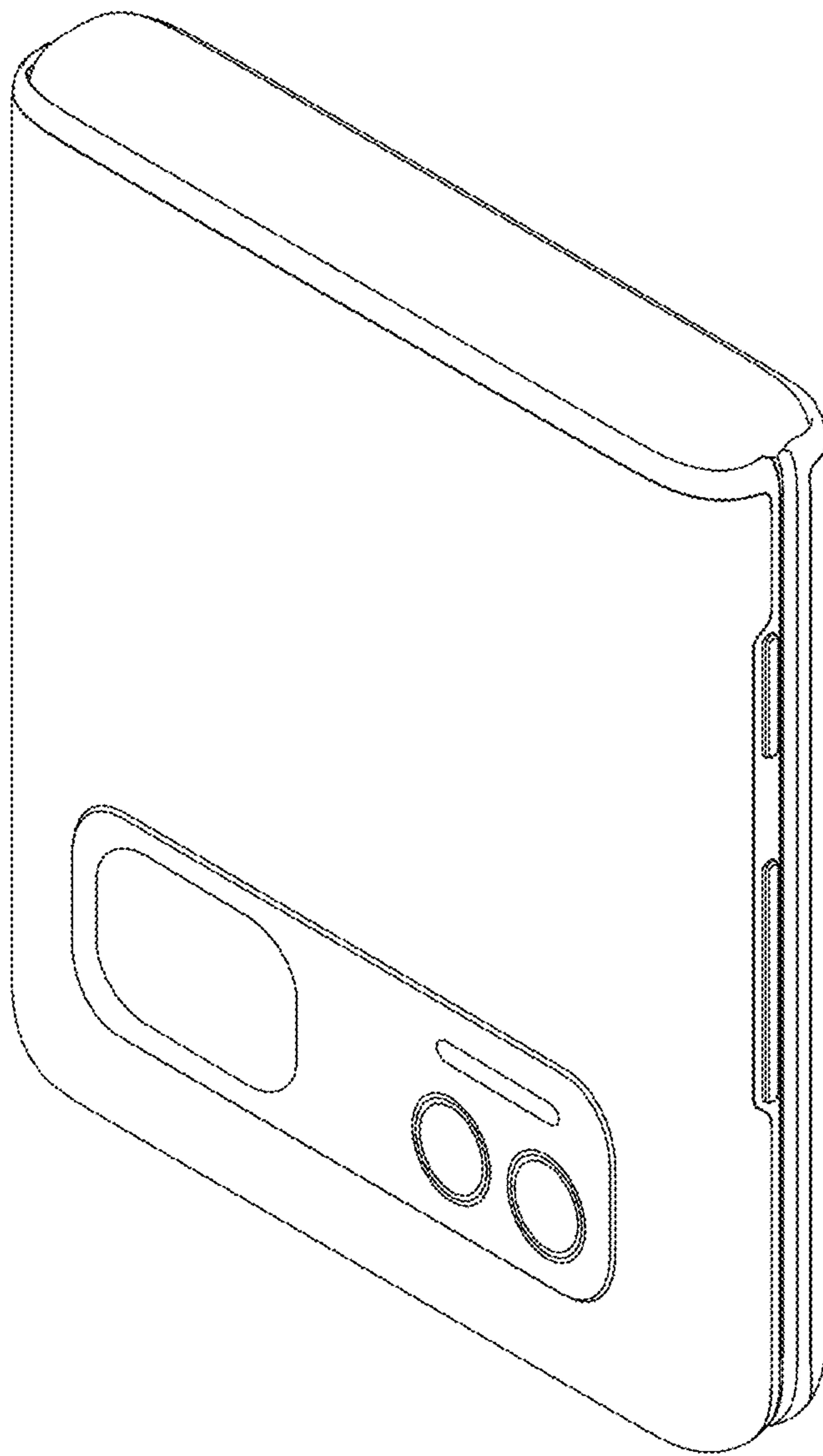
**FIG. 12**



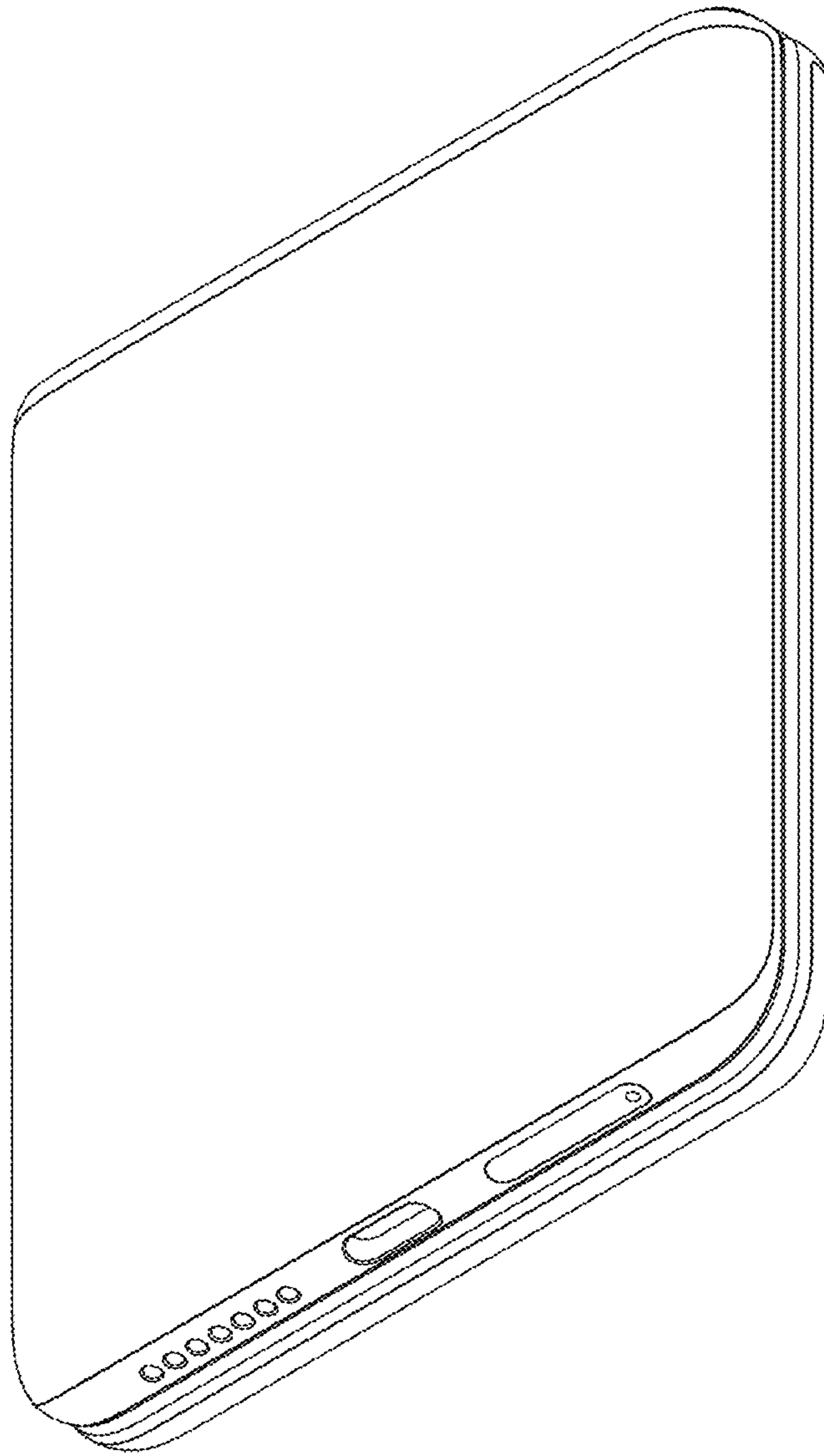
*FIG. 13*



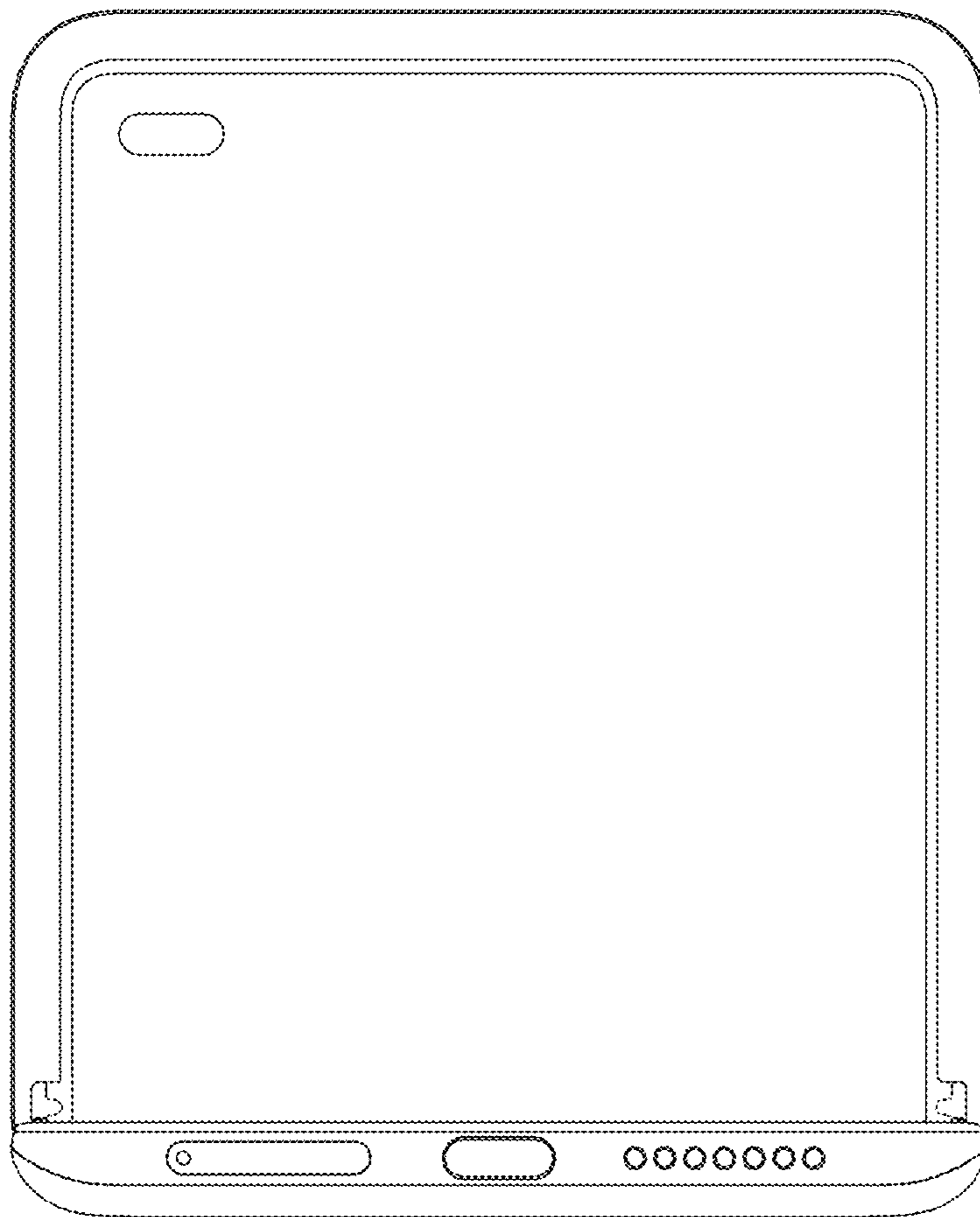
*FIG. 14*



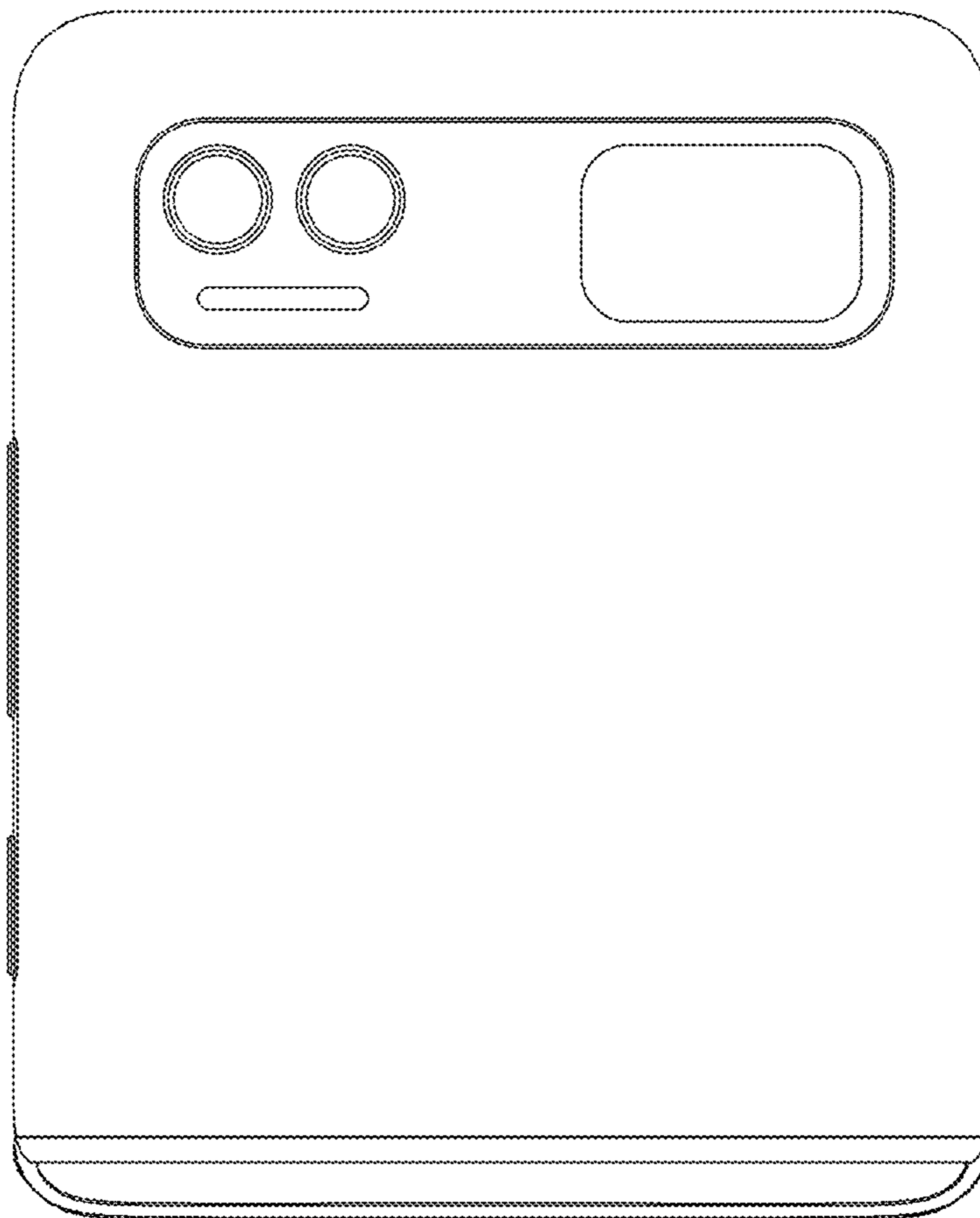
**FIG. 15**



**FIG. 16**

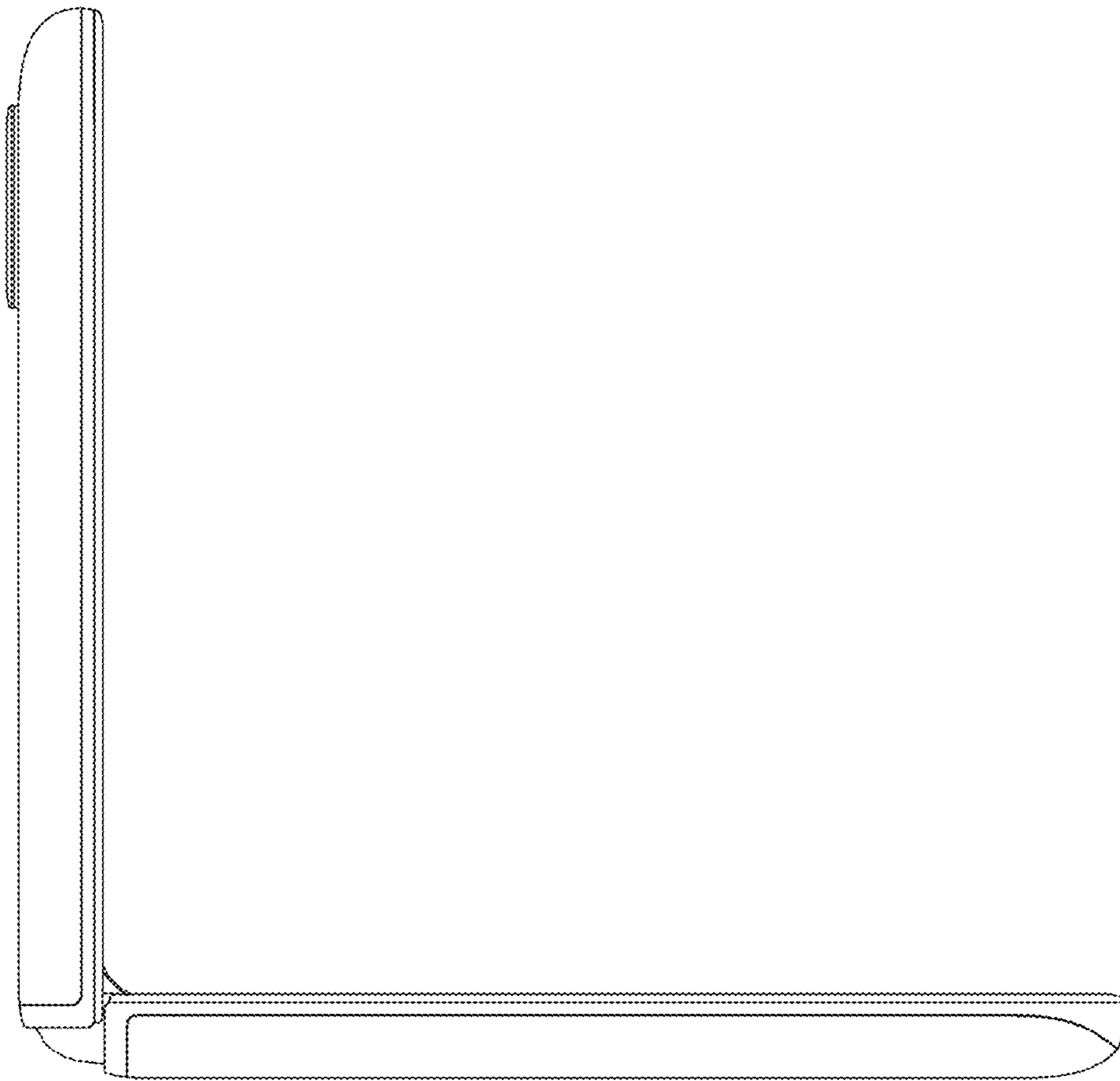


*FIG. 17*

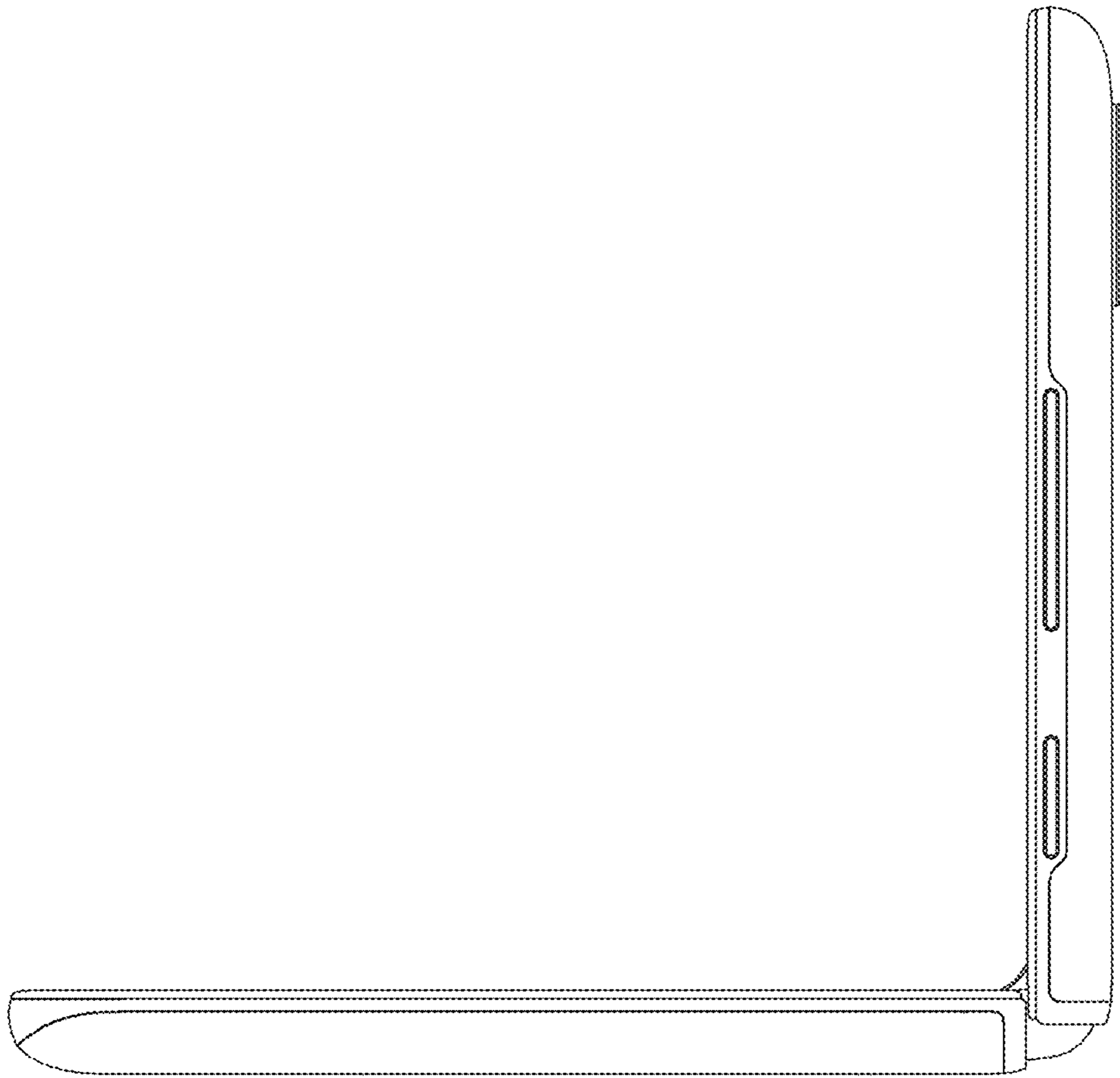


**FIG. 18**

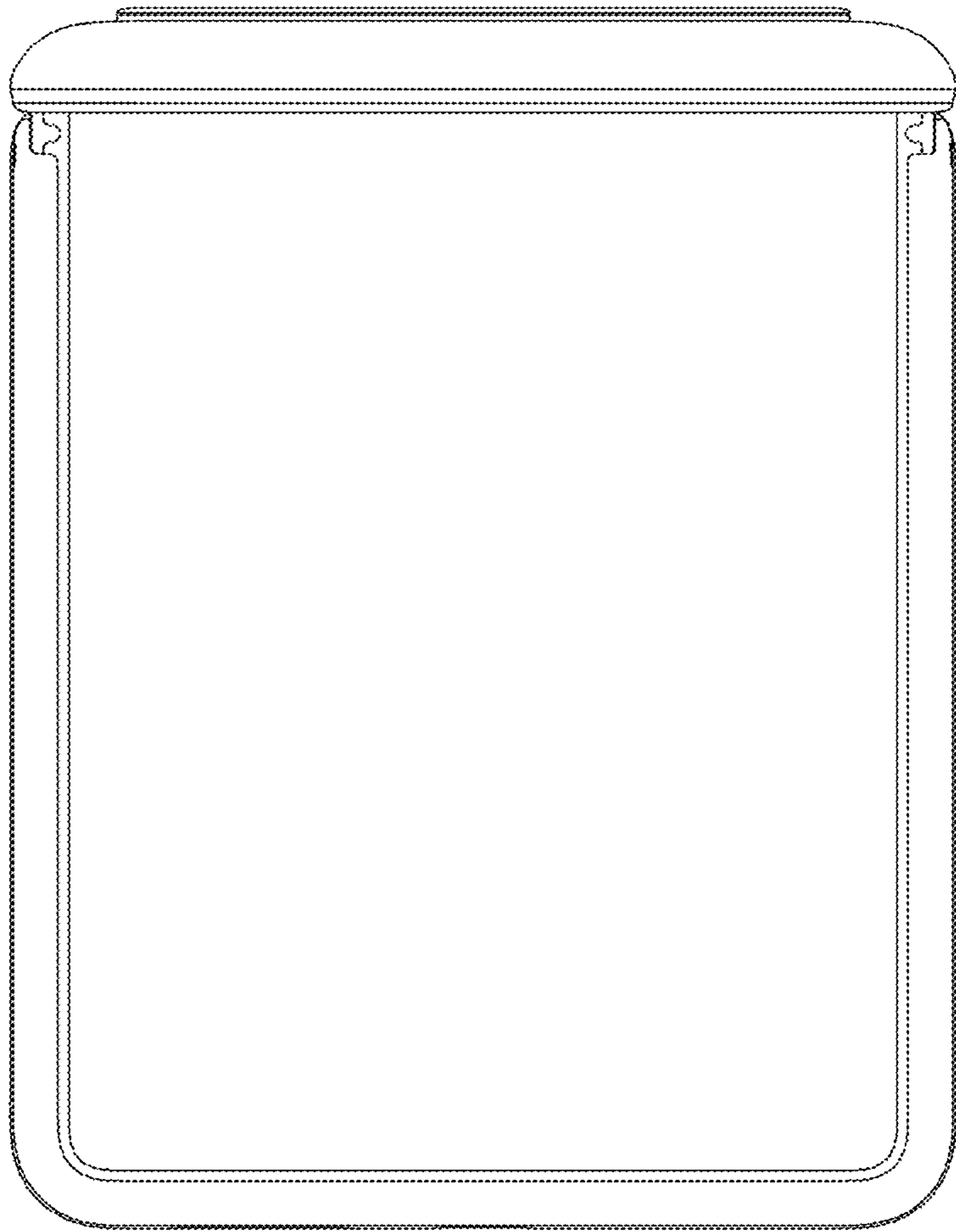




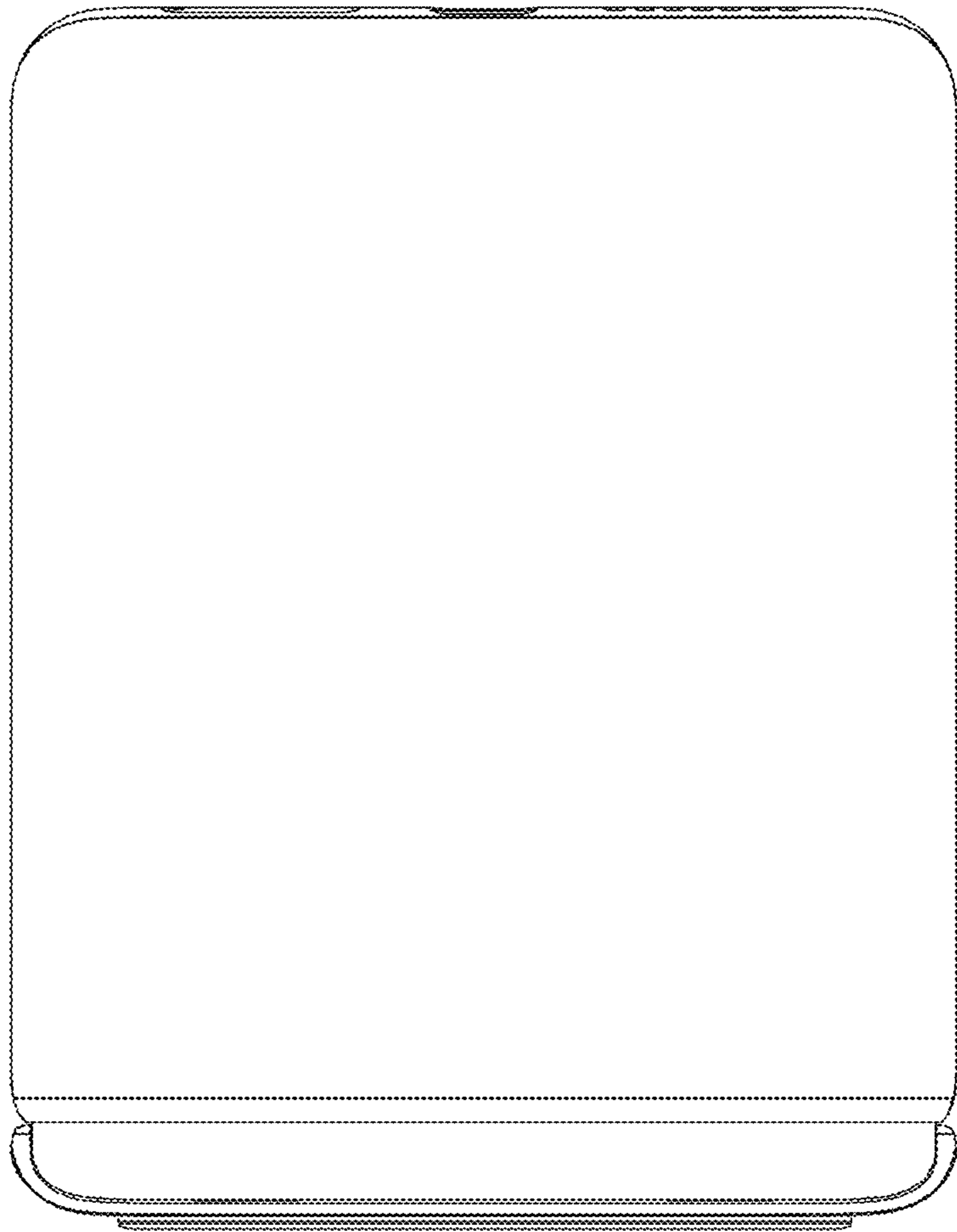
**FIG. 19**



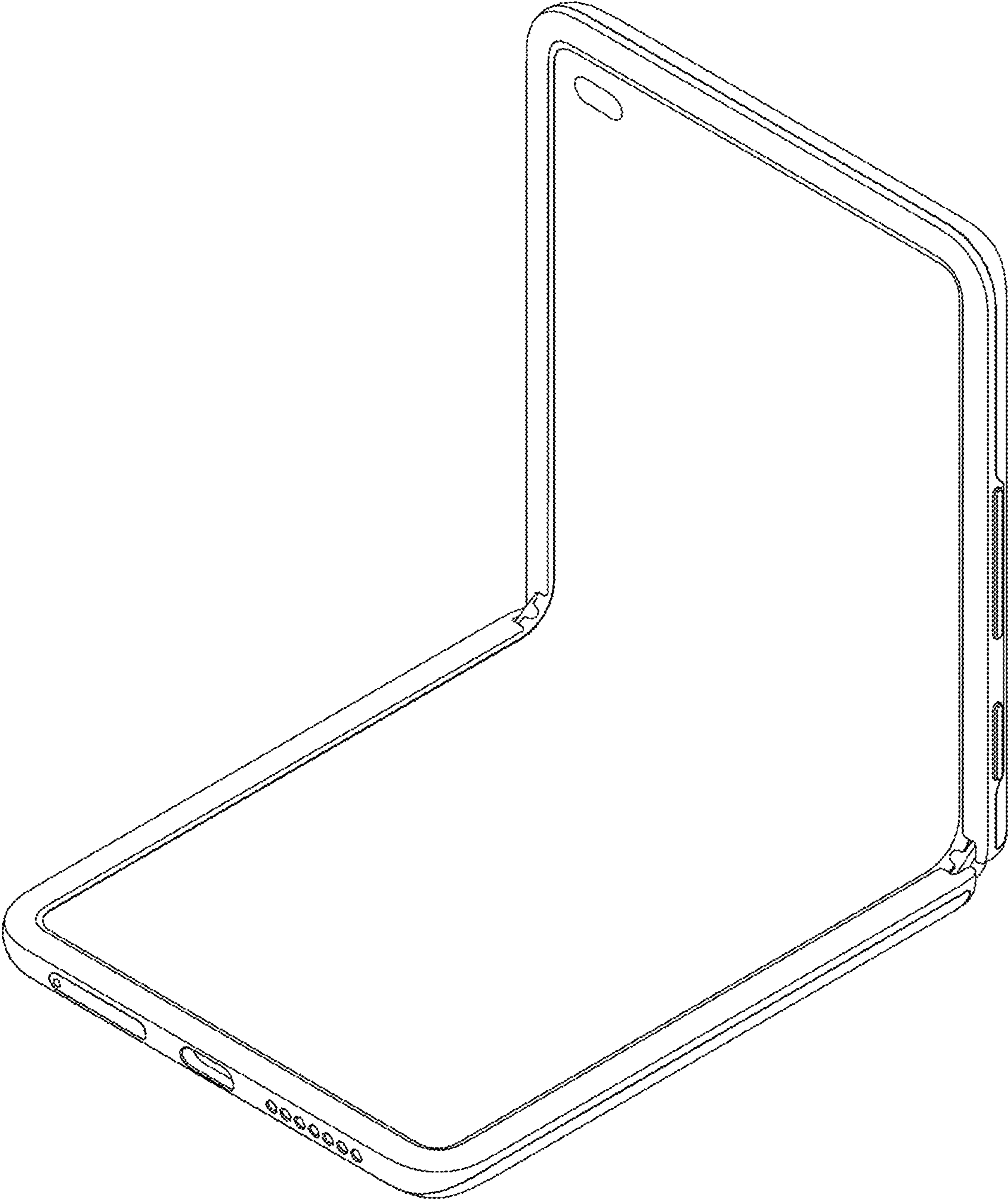
*FIG. 20*



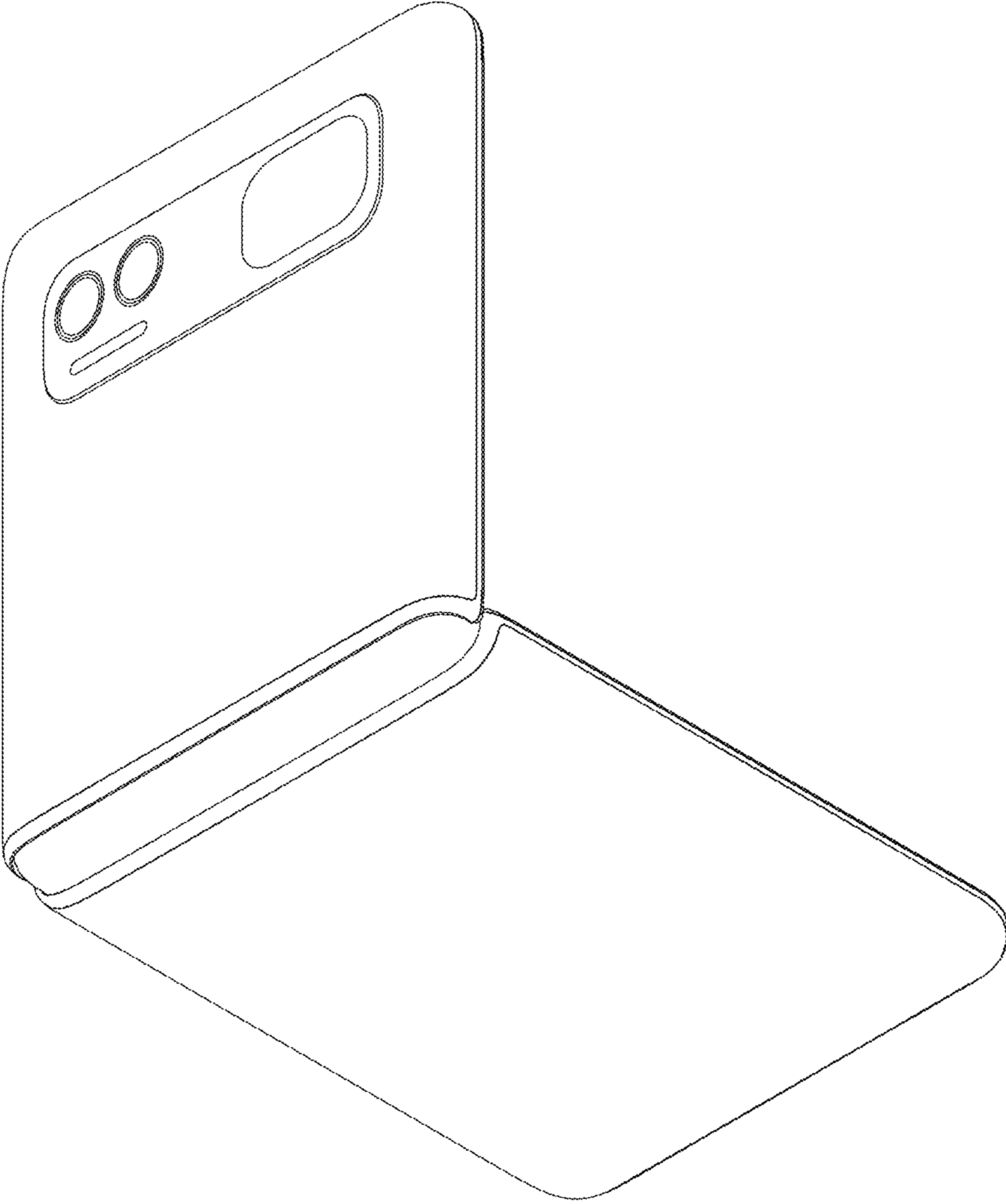
*FIG. 21*



**FIG. 22**



**FIG. 23**



**FIG. 24**