



US00D964302S

(12) **United States Design Patent** (10) **Patent No.:** **US D964,302 S**  
**Lee et al.** (45) **Date of Patent:** **\*\* \*Sep. 20, 2022**

(54) **MOBILE PHONE**

- (71) Applicant: **LG ELECTRONICS INC.**, Seoul (KR)
- (72) Inventors: **Jonghak Lee**, Seoul (KR); **Sojin Kim**, Seoul (KR); **Jinki Min**, Seoul (KR); **Hongkyu Park**, Seoul (KR); **Seunghyun Ji**, Seoul (KR)
- (73) Assignee: **LG ELECTRONICS INC.**, Seoul (KR)
- (\*) Notice: This patent is subject to a terminal disclaimer.
- (\*\*) Term: **15 Years**

(21) Appl. No.: **29/708,887**

(22) Filed: **Oct. 10, 2019**

(30) **Foreign Application Priority Data**

Apr. 10, 2019 (JP) ..... 2019-007900

(51) **LOC (13) Cl.** ..... **14-03**

(52) **U.S. Cl.**  
USPC ..... **D14/138 AD; D14/341**

(58) **Field of Classification Search**  
USPC ..... D14/138 AD, 138 R, 138 AA, 341, 345, D14/346, 203.1, 203.3, 203.4, 203.7, 248,  
(Continued)

(56) **References Cited**

**U.S. PATENT DOCUMENTS**

D536,684 S \* 2/2007 Kim ..... D14/138 AD  
D546,313 S \* 7/2007 Lheem ..... D14/138 AD  
(Continued)

**FOREIGN PATENT DOCUMENTS**

CN 303428801 \* 11/2015  
JP D1370691 \* 10/2009  
(Continued)

**OTHER PUBLICATIONS**

Rollable display smartphones are coming Next!, GadgetMatch, youtube.com, dated Mar. 5, 2020, [online], [site visited Feb. 20, 2021]. Available from Internet, URL: <https://www.youtube.com/watch?v=uzExejMsVOY> (Year: 2020).\*

(Continued)

*Primary Examiner* — Jeffrey D Asch

(74) *Attorney, Agent, or Firm* — Birch Stewart, Kolasch & Birch, LLP

(57) **CLAIM**

The ornamental design for a mobile phone, as shown and described.

**DESCRIPTION**

FIG. 1 is a front perspective view of the mobile phone showing our new design;  
FIG. 2 is a front view thereof;  
FIG. 3 is a rear view thereof;  
FIG. 4 is a left side view thereof;  
FIG. 5 is a right side view thereof;  
FIG. 6 is a top plan view thereof;  
FIG. 7 is a bottom plan view thereof;  
FIG. 8 is a rear perspective view thereof;  
FIG. 9 is a rear perspective view showing the use state in which rear display part is operated, showing example displayed information;  
FIG. 10 is a front perspective view in a condition that the claimed design has been expanded completely;  
FIG. 11 is a front view of FIG. 10;  
FIG. 12 is a rear view of FIG. 10;  
FIG. 13 is a left side view of FIG. 10;  
FIG. 14 is a right side view of FIG. 10;  
FIG. 15 is a top plan view of FIG. 10;  
FIG. 16 is a bottom plan view of FIG. 10; and,  
FIG. 17 is a rear perspective view of FIG. 10.  
The broken lines depict portions of the mobile phone, and example displayed information in FIG. 9, that form no part of the claimed design.

**1 Claim, 17 Drawing Sheets**

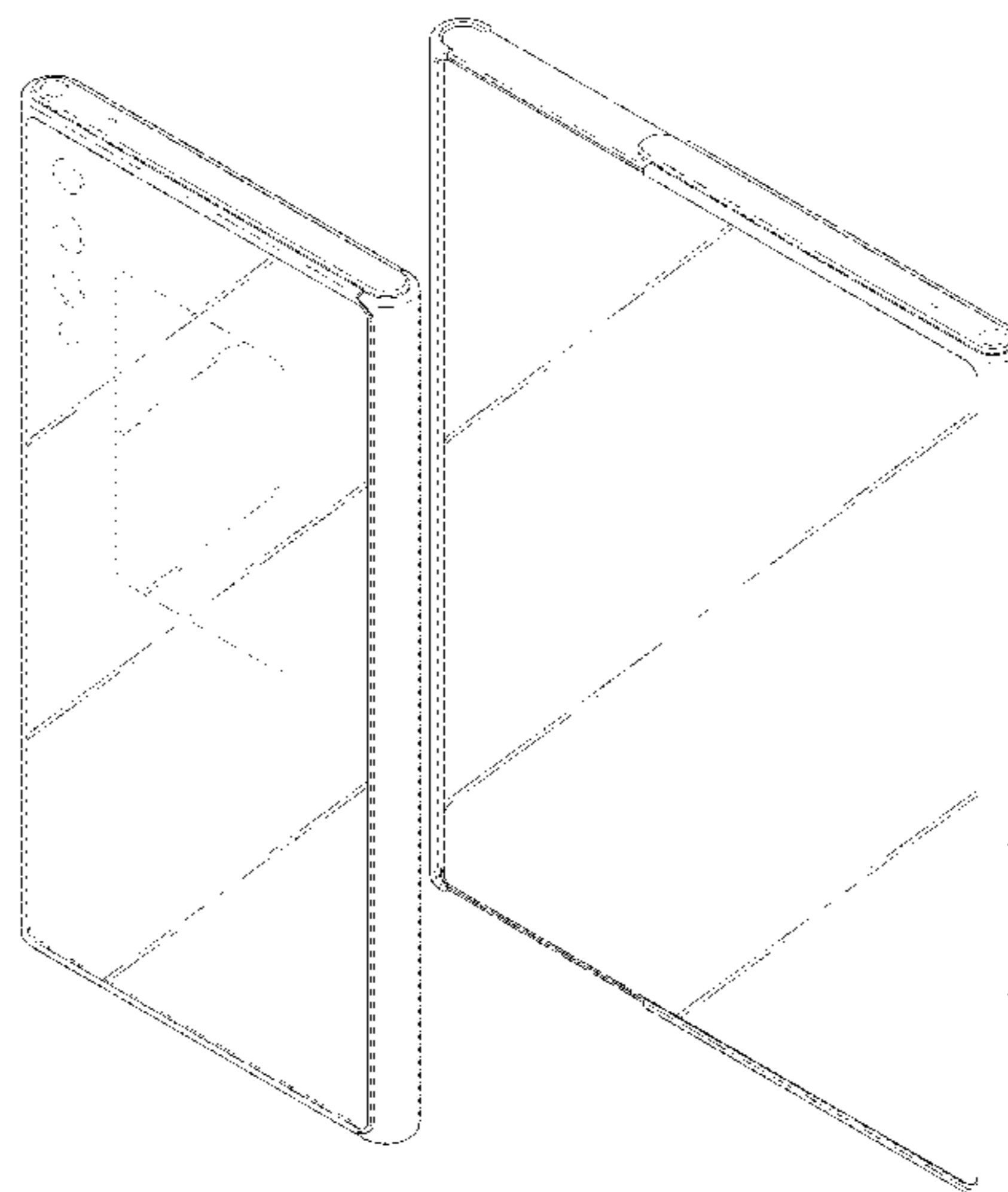

(58) **Field of Classification Search**

USPC ..... D14/132, 501, 336, 496; D21/517;  
D6/704; D16/241

CPC .... H04M 1/0237; H04M 1/206; H04M 1/208;  
H04M 1/0241; H04M 1/0268; G06F  
1/1652; G06F 1/1624

See application file for complete search history.

2020/0348727 A1\* 11/2020 Lee ..... G06F 1/1626  
2020/0383214 A1\* 12/2020 Kim ..... H05K 1/147  
2021/0181801 A1\* 6/2021 Yin ..... G06F 1/1652  
2021/0191472 A1\* 6/2021 Kim ..... G06F 1/162  
2021/0201709 A1\* 7/2021 Lee ..... G06F 3/0481  
2021/0306446 A1\* 9/2021 Choi ..... H04N 5/2253  
2021/0375165 A1\* 12/2021 Feng ..... G06F 1/1652  
2021/0405703 A1\* 12/2021 Song ..... G06F 1/1652  
2022/0019261 A1\* 1/2022 Kang ..... H04M 1/0277

(56) **References Cited**

U.S. PATENT DOCUMENTS

D551,647 S \* 9/2007 Kim ..... D14/138 AD  
D608,318 S \* 1/2010 Kim ..... D14/138 G  
D631,458 S \* 1/2011 Liao ..... D14/138 G  
D712,401 S \* 9/2014 Lee ..... D14/341  
D716,253 S \* 10/2014 Lee ..... D14/138 G  
D722,036 S \* 2/2015 Nam ..... D14/138 G  
D750,067 S \* 2/2016 Park ..... D14/203.3  
D750,617 S \* 3/2016 Akana ..... D14/341  
D761,253 S \* 7/2016 Yamazaki ..... D14/341  
D762,608 S \* 8/2016 Yoon ..... D14/138 G  
D766,891 S \* 9/2016 Hong ..... D14/341  
D768,594 S \* 10/2016 Szeto ..... D14/138 G  
10,553,135 B2 \* 2/2020 Lee ..... G06F 3/147  
D902,899 S \* 11/2020 Seo ..... D14/248  
10,880,417 B1 \* 12/2020 Song ..... H04M 1/0237  
10,936,017 B1 \* 3/2021 Choi ..... G06F 1/1643  
D915,336 S \* 4/2021 Lee ..... D14/138 AD  
D923,598 S \* 6/2021 Lee ..... H04M 1/0268  
D14/138 AD  
11,051,413 B2 \* 6/2021 Yang ..... G06F 1/1626  
D926,718 S \* 8/2021 Lee ..... G06F 1/1624  
D14/138 AD  
D936,625 S \* 11/2021 Lee ..... D14/138 AD  
D936,626 S \* 11/2021 Lee ..... D14/138 AD  
D936,627 S \* 11/2021 Lee ..... D14/138 AD  
D940,677 S \* 1/2022 Min ..... D14/138 AD  
D940,680 S \* 1/2022 Lee ..... D14/138 AD  
2008/0125171 A1 \* 5/2008 Shin ..... H04M 1/03  
455/556.1  
2012/0314400 A1 \* 12/2012 Bohn ..... G09F 9/35  
361/679.01  
2013/0058063 A1 \* 3/2013 O'Brien ..... G06F 1/1624  
361/807  
2014/0194165 A1 \* 7/2014 Hwang ..... G06F 1/1652  
455/566  
2016/0041716 A1 \* 2/2016 Richardson ..... G06F 1/1637  
345/173  
2016/0274718 A1 \* 9/2016 Burr ..... G06F 3/0412  
2017/0364119 A1 \* 12/2017 Lee ..... G06F 1/1656  
2018/0014417 A1 \* 1/2018 Seo ..... G02F 1/13  
2018/0373408 A1 \* 12/2018 Lee ..... G06F 1/1643  
2020/0022271 A1 \* 1/2020 Park ..... H05K 5/0017  
2020/0253063 A1 \* 8/2020 Jiang ..... H05K 5/0017  
2020/0264826 A1 \* 8/2020 Kwon ..... G06F 3/0416  
2020/0267247 A1 \* 8/2020 Song ..... H04M 1/0268  
2020/0341514 A1 \* 10/2020 Li ..... G06F 1/1652

FOREIGN PATENT DOCUMENTS

JP D1476428 \* 8/2013  
WO D203815-001 \* 11/2019  
WO D202678-001 \* 12/2019

OTHER PUBLICATIONS

LG's Rollable Phone is becoming a Reality!, TechAvid youtube.com, dated Dec. 2, 2020, [online], [site visited Feb. 20, 2021]. Available from Internet, URL: <https://www.youtube.com/watch?v=tZK6a4-GunE> (Year: 2020).\*

Oppo Rollable Display Phone Hands-on Experience, Creator Studio, youtube.com, dated Nov. 17, 2020, [online], [site visited Feb. 20, 2021]. Available from Internet, URL: <https://www.youtube.com/watch?v=CUTmYqJcVpQ> (Year: 2020).\*

TCL's sliding-screen concept phone, CNET, youtube.com, dated Mar. 5, 2020, [online], [site visited Feb. 20, 2021]. Available from Internet, URL: <https://www.youtube.com/watch?v=kl5H7NhNTg> (Year: 2020).\*

Oppo X 2021 Rollable Concept Phone Truly Looks Like the Next Big Thing, by Kelvin, Nov. 18, 2020, Concept Phones, [online], [site visited Feb. 20, 2021]. Available from Internet, URL: <https://www.concept-phones.com/news/oppo-x-2021-rollable-concept-phone-truly-looks-like-the-next-big-thing/> (Year: 2020).\*

The Scroll is Back! Flexible Device Has Scrollable Part Coming Out, by Kelvin, Mar. 14, 2018, Concept Phones, [online], [site visited Feb. 20, 2021]. Available from Internet, URL: <https://www.concept-phones.com/samsung/scroll-flexible-device-scrollable-part-coming/> (Year: 2018).\*

LG Rollable Phone Versus TCL Rollable Phone; Who Won CES 2021?, by Kelvin, Jan. 14, 2021, Concept Phones, [online], [site visited Feb. 20, 2021]. Available from Internet, URL: <https://www.concept-phones.com/lg/lg-rollable-phone-versus-tcl-rollable-phone-who-won-ces-2021/> (Year: 2021).\*

Shh, Samsung will demo phone with a slide-out display at a secret meeting today, Daniel Petrov, Jan. 7, 2020, PhoneArena, [online], [site visited Feb. 20, 2021]. Available from Internet, URL: [https://www.phonearena.com/news/samsung-slide-display-phone-ces-2020\\_id121415](https://www.phonearena.com/news/samsung-slide-display-phone-ces-2020_id121415) (Year: 2020).\*

Top 5 Rollable Phones with Sliding screens 2021 | Rollable Smartphones | Rolling Display Phones, Top 5 Gadgets, youtube.com, dated Nov. 25, 2020, [online], [site visited Feb. 20, 2021]. Available from Internet, URL: <https://www.youtube.com/watch?v=ZjofT-71k8U> (Year: 2020).\*

\* cited by examiner

FIG. 1

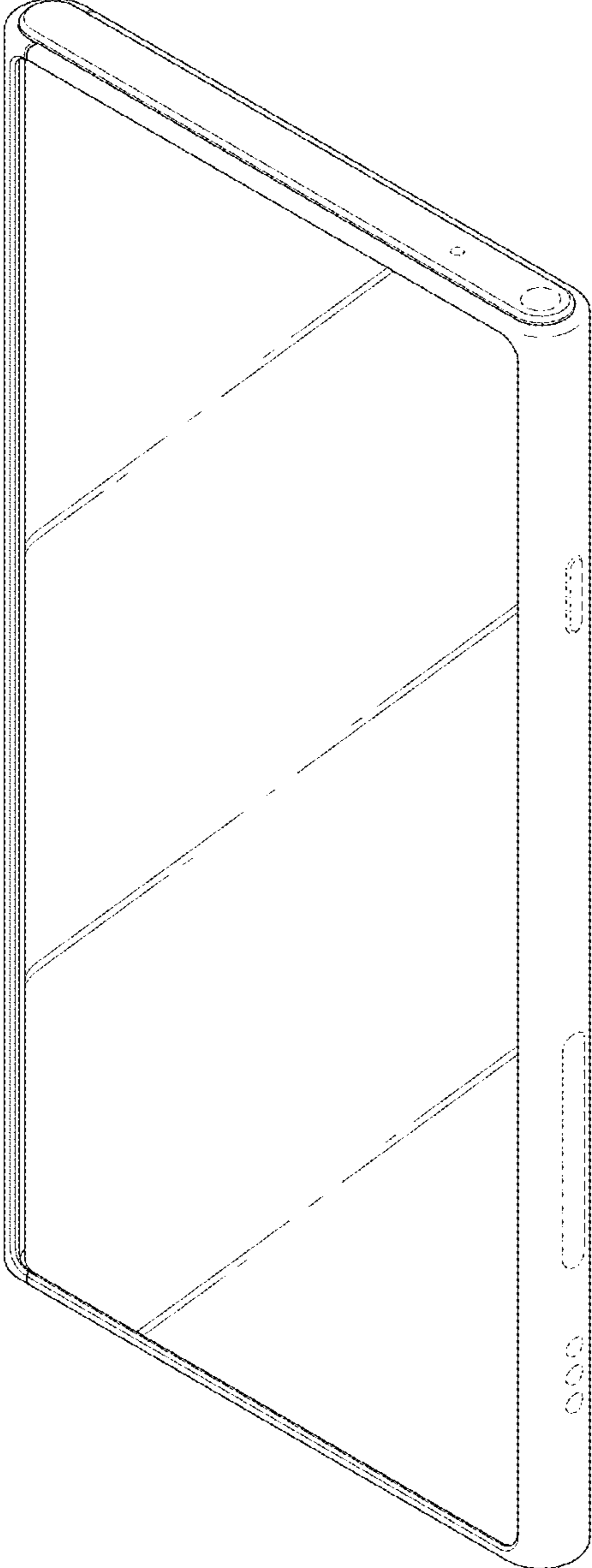

FIG. 2

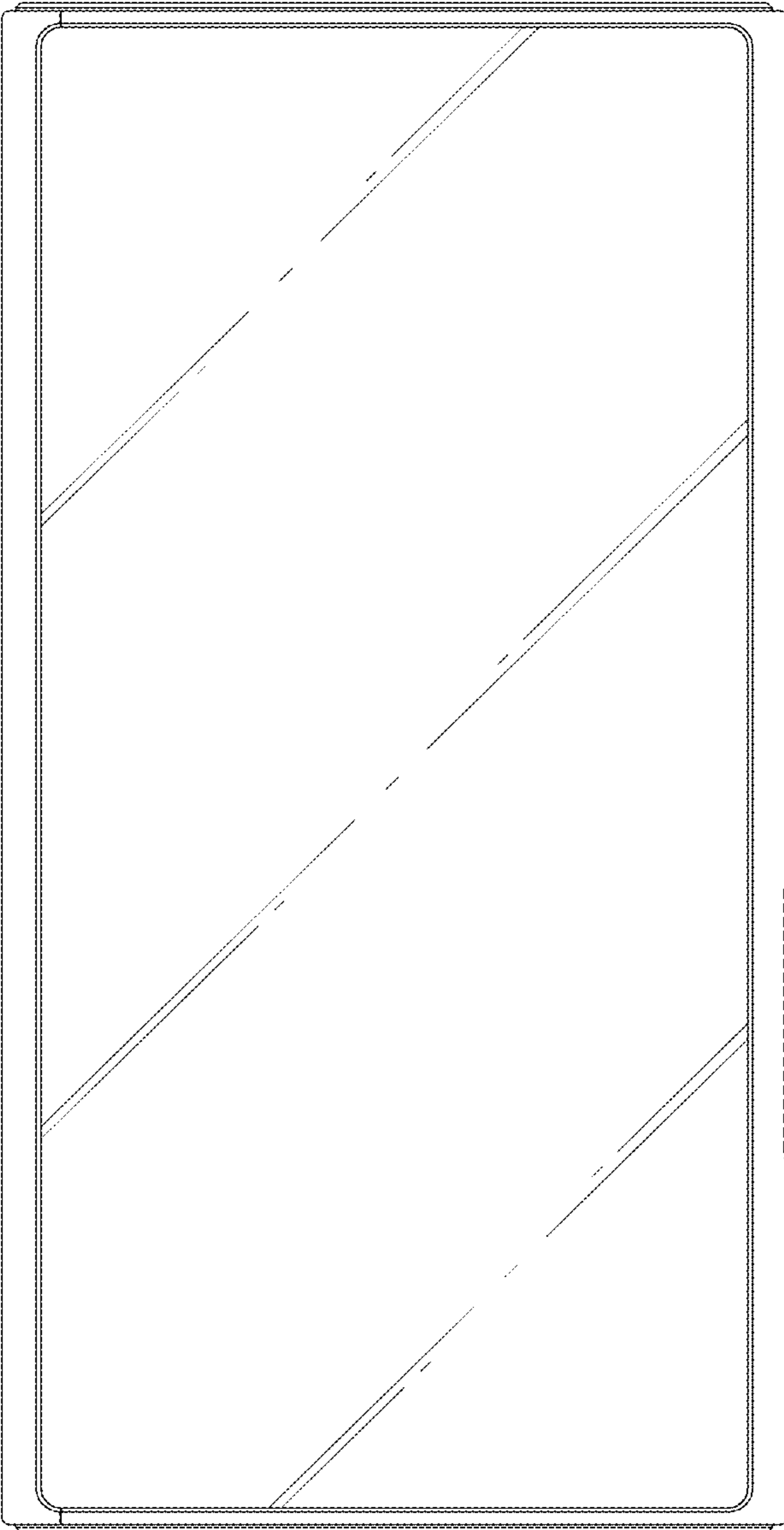

FIG. 3

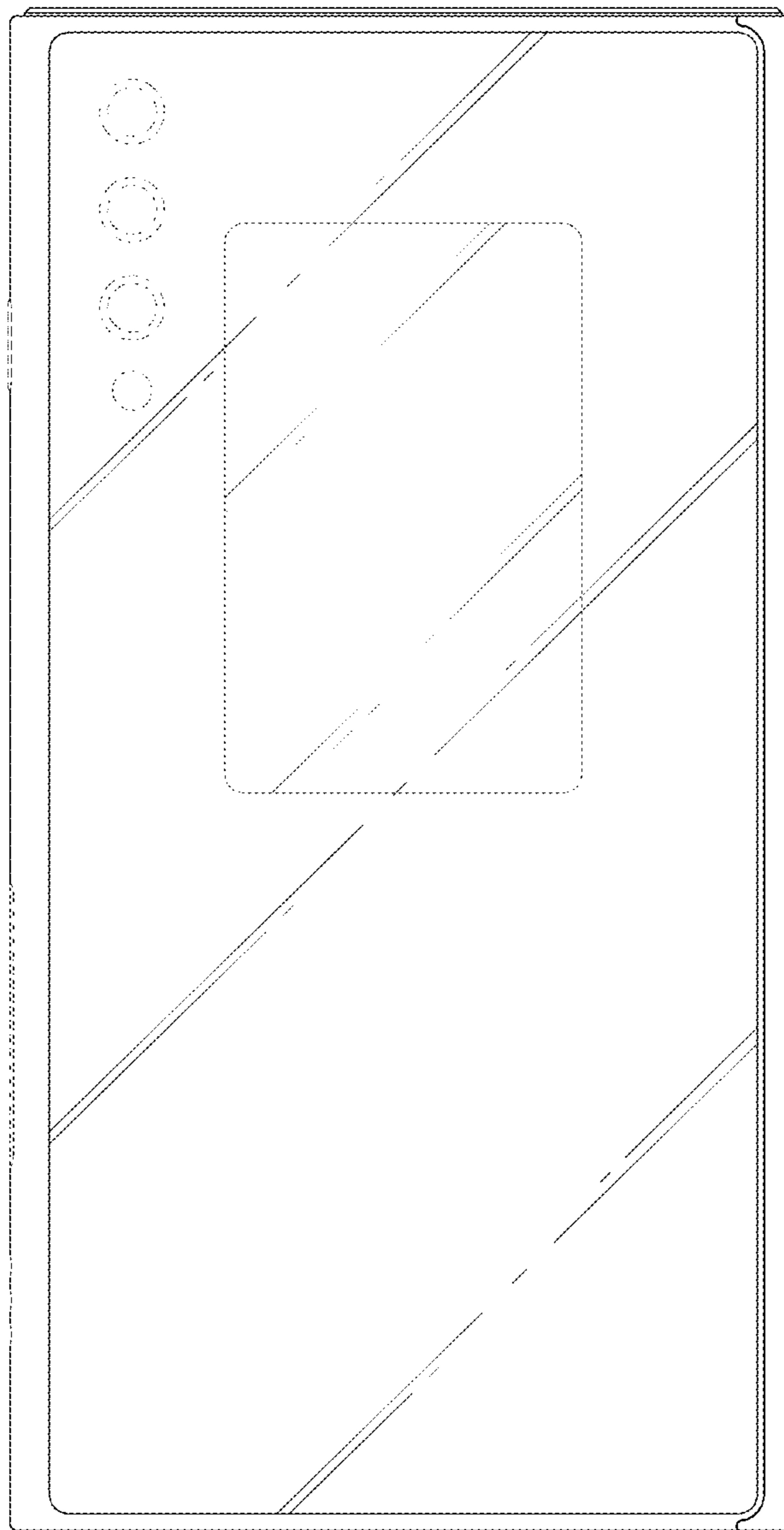

FIG. 4

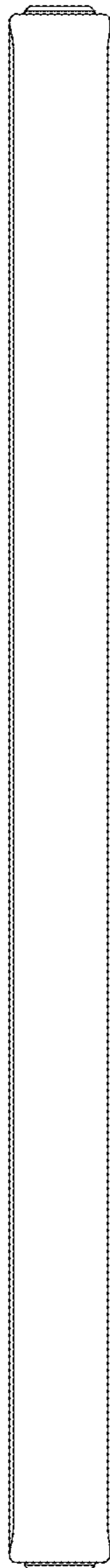

FIG. 5



FIG. 6

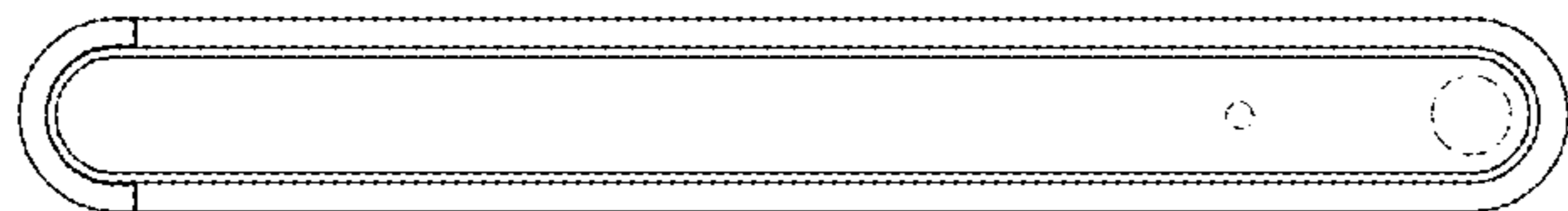



FIG. 7

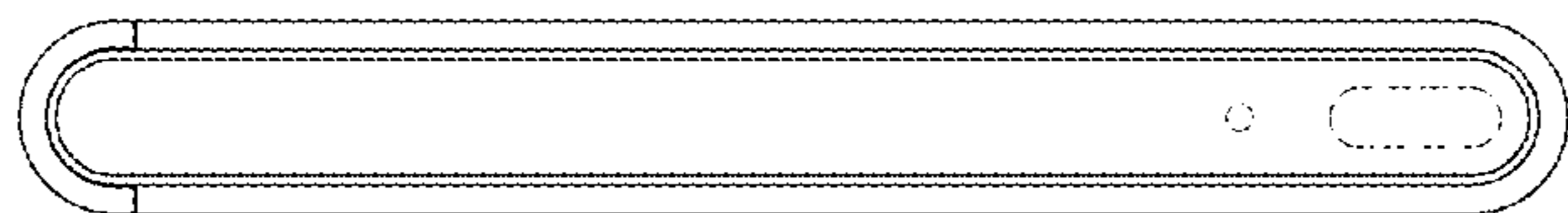

FIG. 8

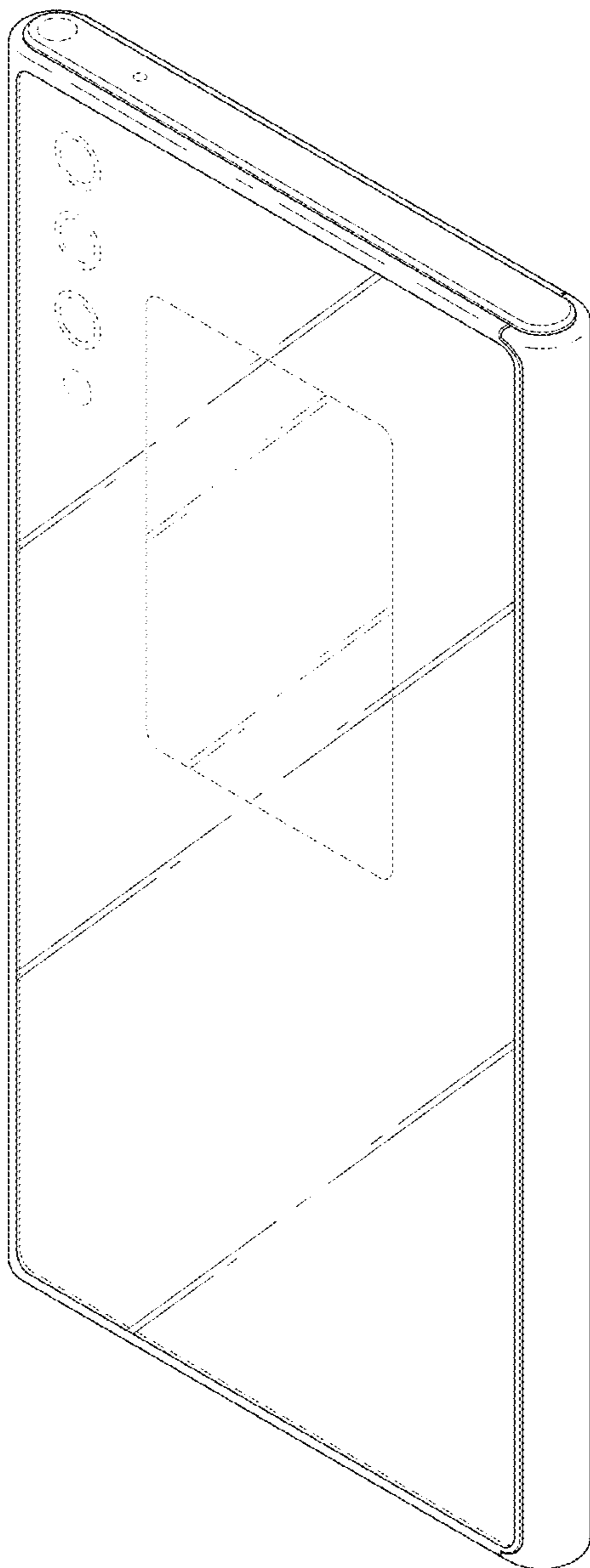

FIG. 9

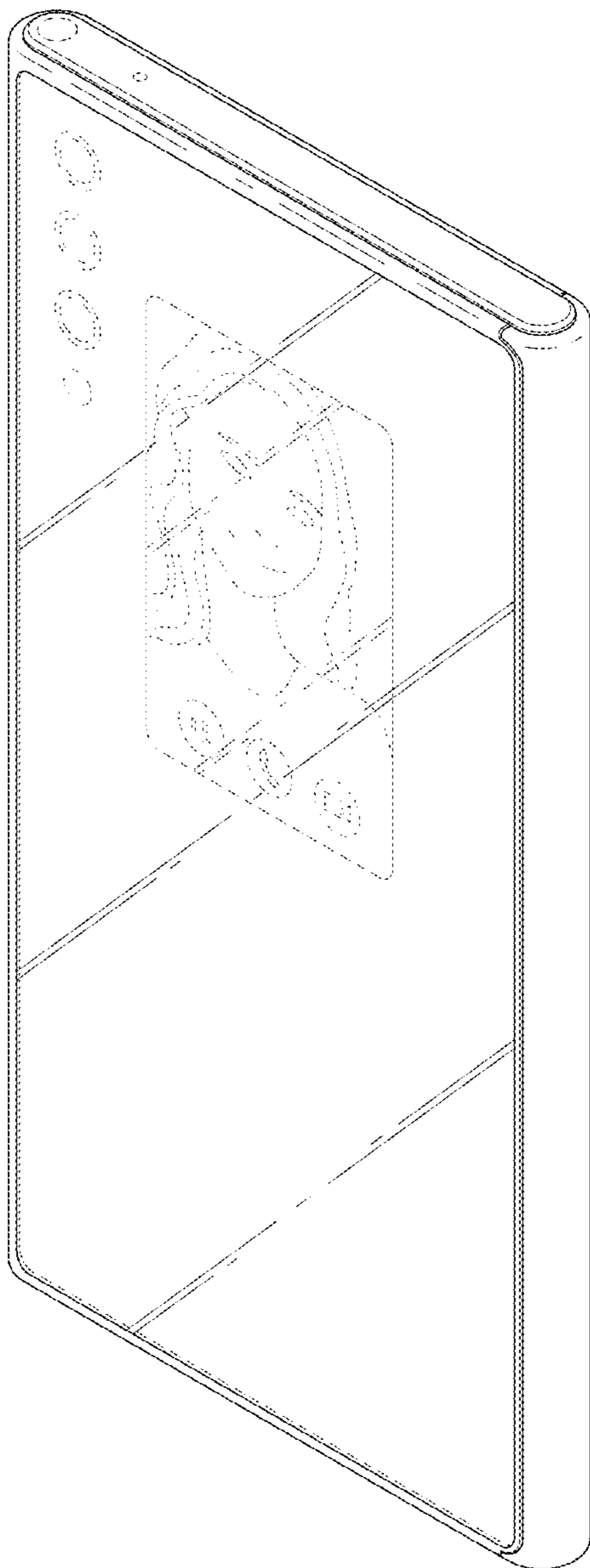

FIG. 10

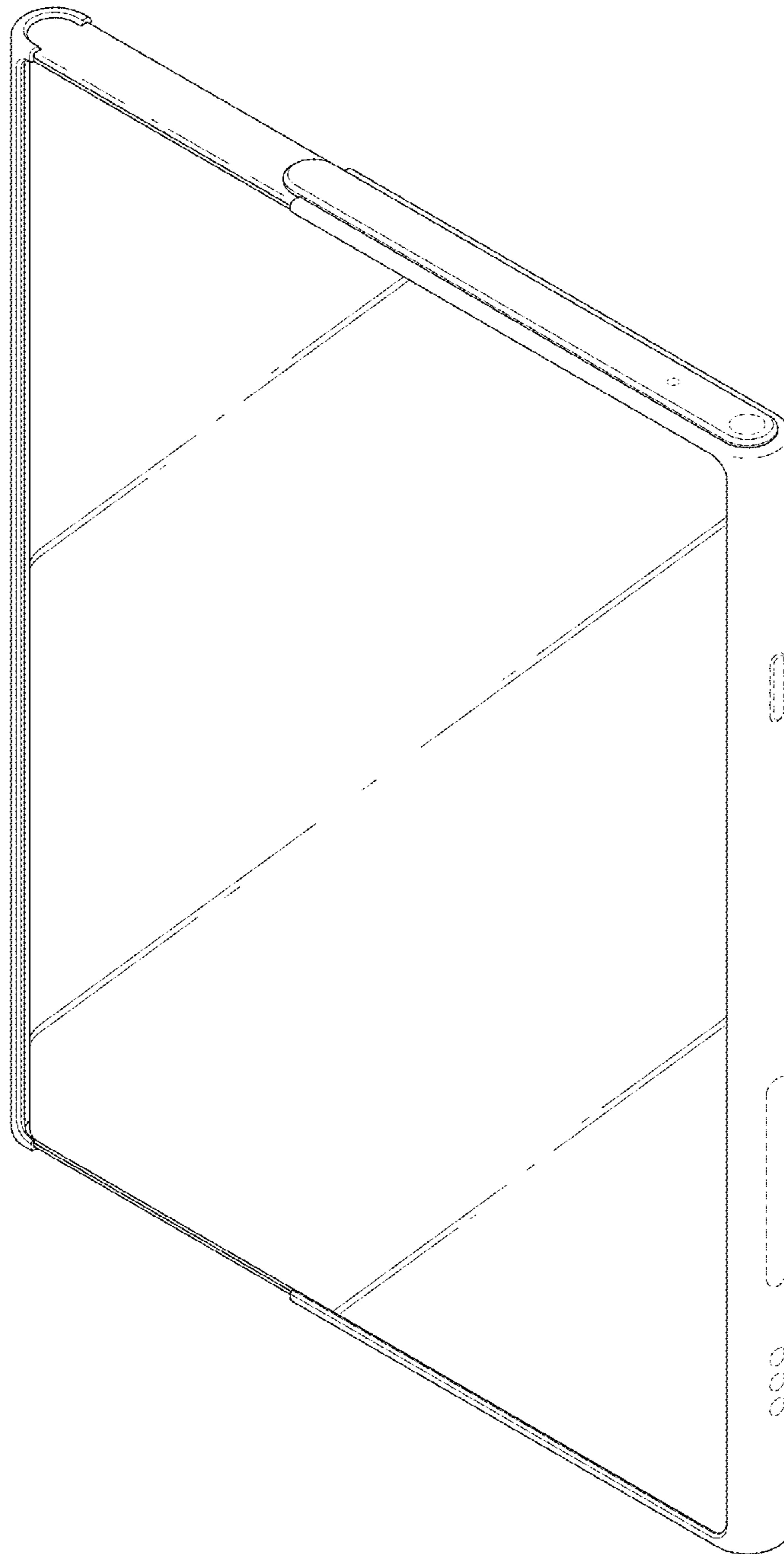

FIG. 11

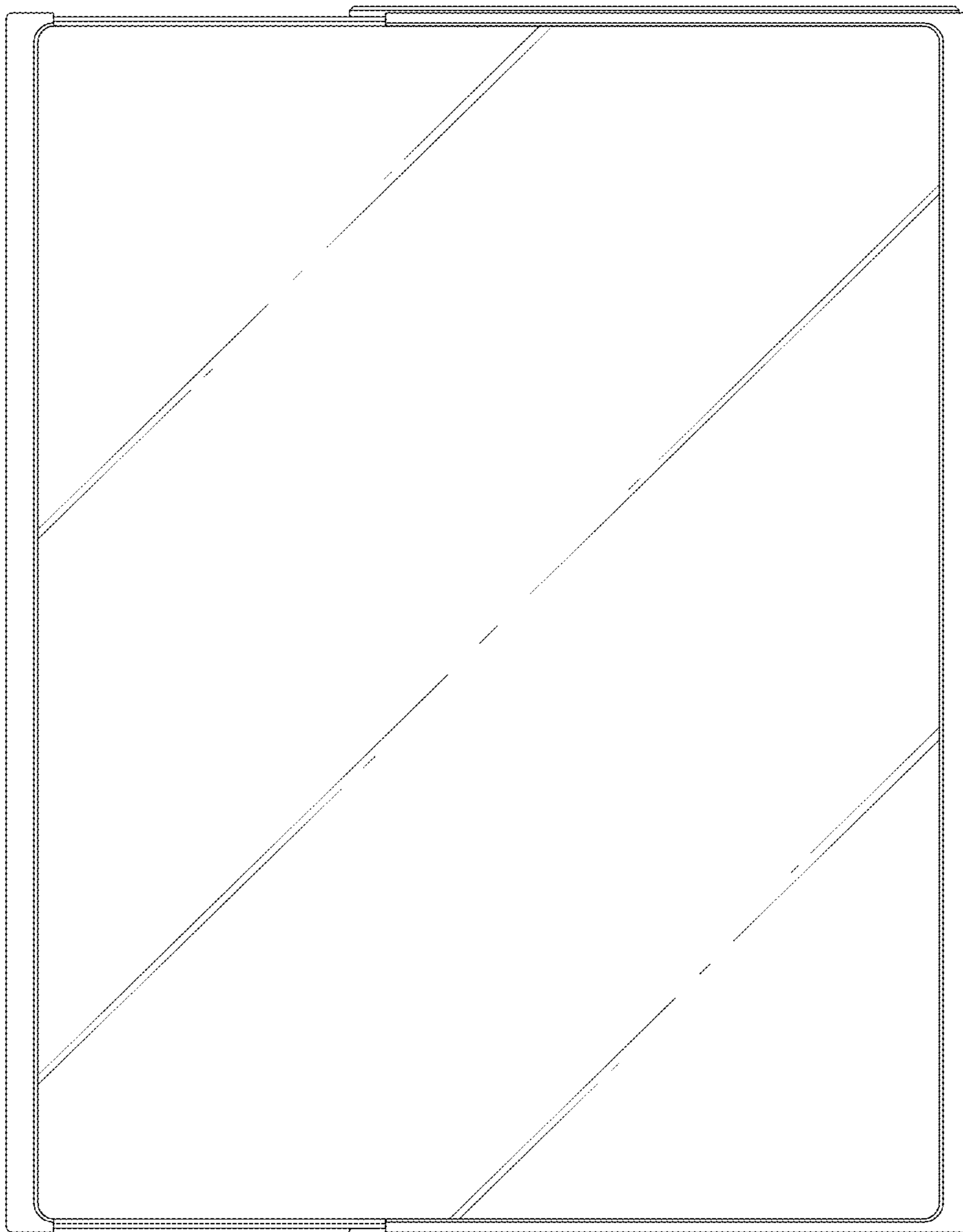

FIG. 12

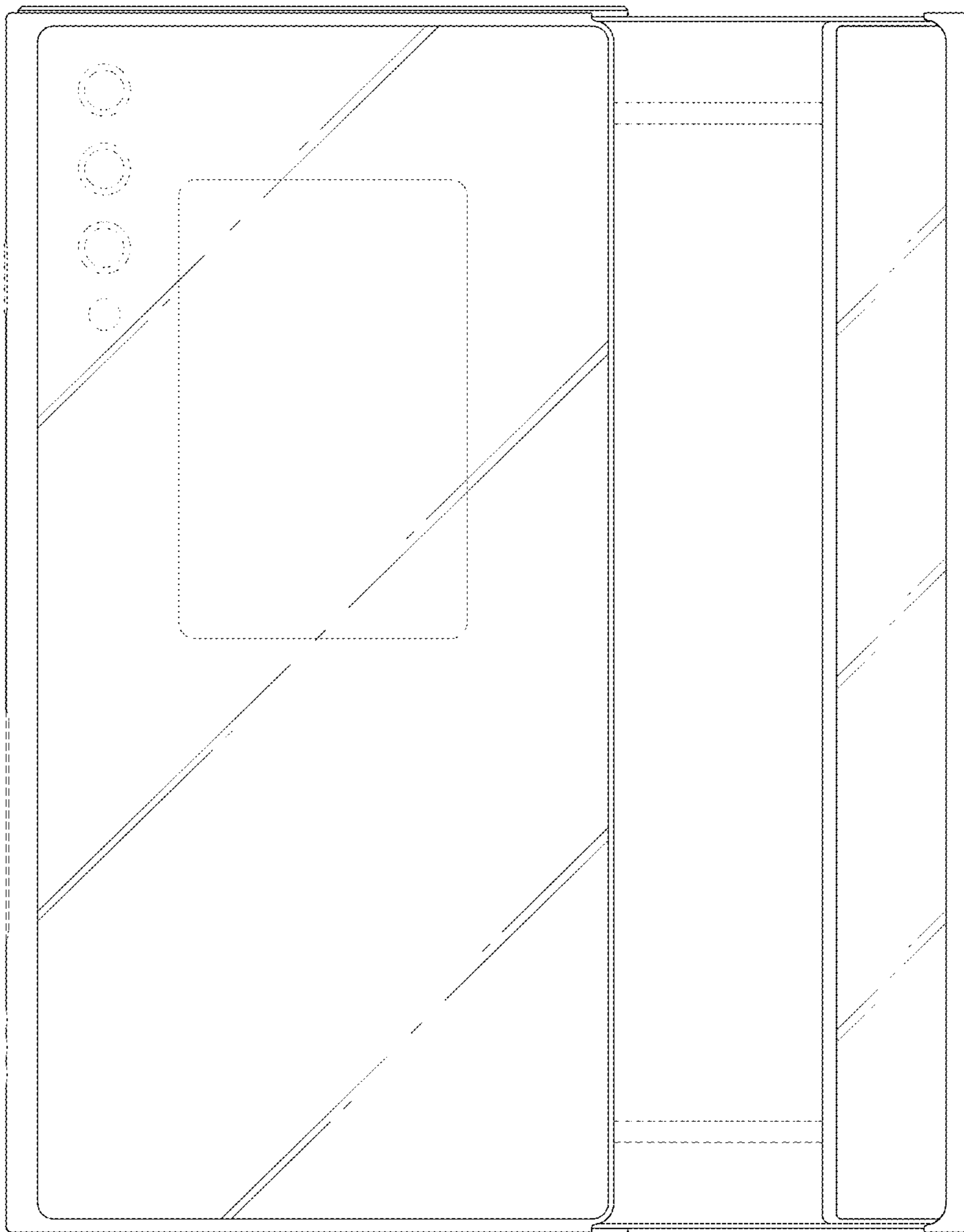

FIG. 13

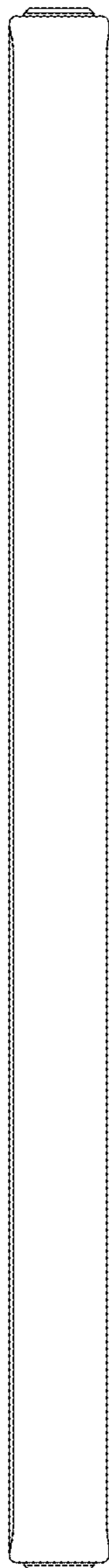

FIG. 14

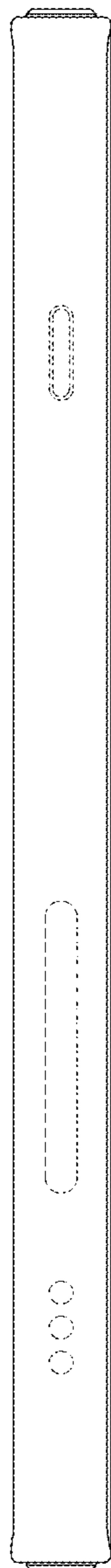



FIG. 15

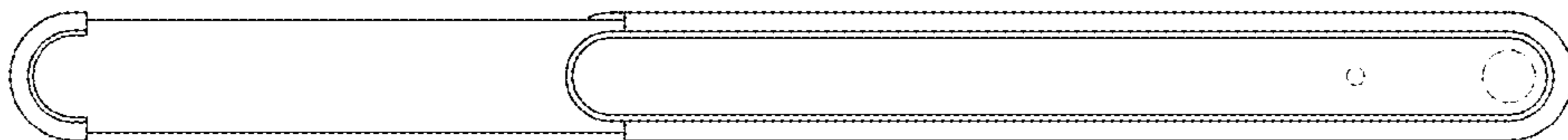

FIG. 16

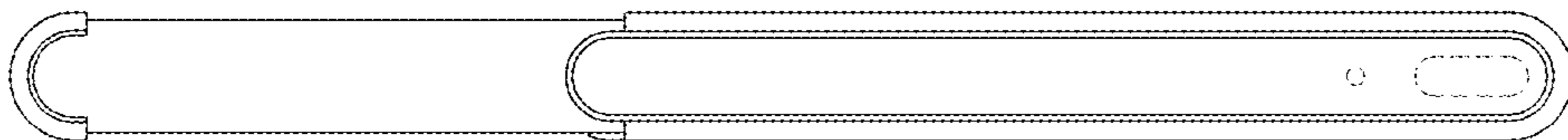

FIG. 17

