

US00D964161S

(12) **United States Design Patent** (10) **Patent No.:** **US D964,161 S**  
**Peterson et al.** (45) **Date of Patent:** **\*\* \*Sep. 20, 2022**

(54) **CONTAINER BASE**

(71) Applicant: **Placon Corporation**, Madison, WI (US)

(72) Inventors: **Pierce J. Peterson**, Oregon, WI (US);  
**Donald E. McCumber**, Madison, WI (US)

(73) Assignee: **PLACON CORPORATION**, Madison, WI (US)

(\*) Notice: This patent is subject to a terminal disclaimer.

(\*\*) Term: **15 Years**

(21) Appl. No.: **29/785,535**

(22) Filed: **May 26, 2021**

(51) **LOC (13) Cl.** ..... **09-03**

(52) **U.S. Cl.**  
USPC ..... **D9/425**

(58) **Field of Classification Search**  
USPC .... D9/420, 423-429, 432; D7/587, 601-602  
See application file for complete search history.

(56) **References Cited**

**U.S. PATENT DOCUMENTS**

5,772,070	A	6/1998	Hayes et al.	
D501,403	S *	2/2005	Wilcock	D9/425
D527,956	S	9/2006	Doliwa	
D533,059	S *	12/2006	Knutson	D9/435
7,284,673	B2	10/2007	Habeger et al.	
D581,266	S *	11/2008	Vovan	D9/429

(Continued)

**OTHER PUBLICATIONS**

Placon Announces New Fresh 'N Clear Tamper Evident Salad Bowl Family. [online] Published Jun. 21, 2022. Retrieved from URL:

<https://www.placon.com/resources/news/placon-announces-new-fresh-n-clear-tamper-evident-salad-bowl-family/> (Year: 2022).\*

(Continued)

*Primary Examiner* — Vy N Koenig

(74) *Attorney, Agent, or Firm* — Stiennon & Stiennon

(57) **CLAIM**

The ornamental design for a container base, as shown and described.

**DESCRIPTION**

FIG. 1 is a front isometric view of a container Base, of embodiment one, showing our new design;  
 FIG. 2 is a right side elevational view thereof;  
 FIG. 3 is a top plan view thereof;  
 FIG. 4 is a cross-sectional view thereof, taken along section line 4-4 in FIG. 3;  
 FIG. 5 is a cross-sectional view thereof, taken along section line 5-5 in FIG. 4;  
 FIG. 6 is a bottom plan view thereof;  
 FIG. 7 is a front elevational view thereof, the rear elevational view being a mirror image thereof;  
 FIG. 8 is a left side elevational view thereof;  
 FIG. 9 is a front isometric view of a container Base, of embodiment two, showing our new design;  
 FIG. 10 is a right side elevational view thereof;  
 FIG. 11 is a top plan view thereof;  
 FIG. 12 is a cross-sectional view thereof, taken along section line 12-12 in FIG. 11;  
 FIG. 13 is a cross-sectional view thereof, taken along section line 13-13 in FIG. 12;  
 FIG. 14 is a bottom plan view thereof;  
 FIG. 15 is a front elevational view thereof, the rear elevational view being a mirror image thereof; and,  
 FIG. 16 is a left side elevational view thereof.

The broken lines in the figures depict portions of the container base and additional environmental structure, including lids, tabs, and bottom structure, that form no part of the claimed design.

**1 Claim, 8 Drawing Sheets**

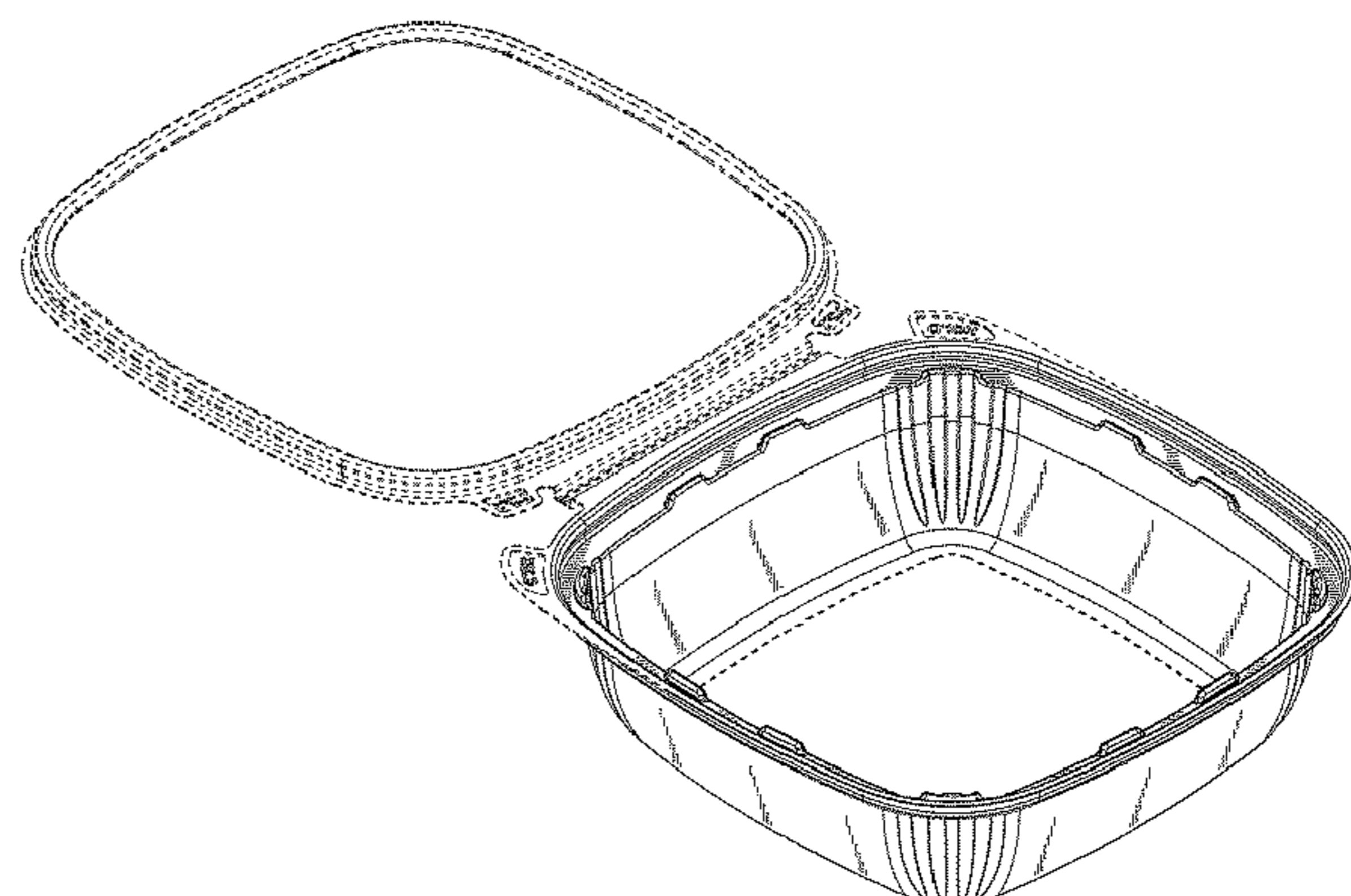
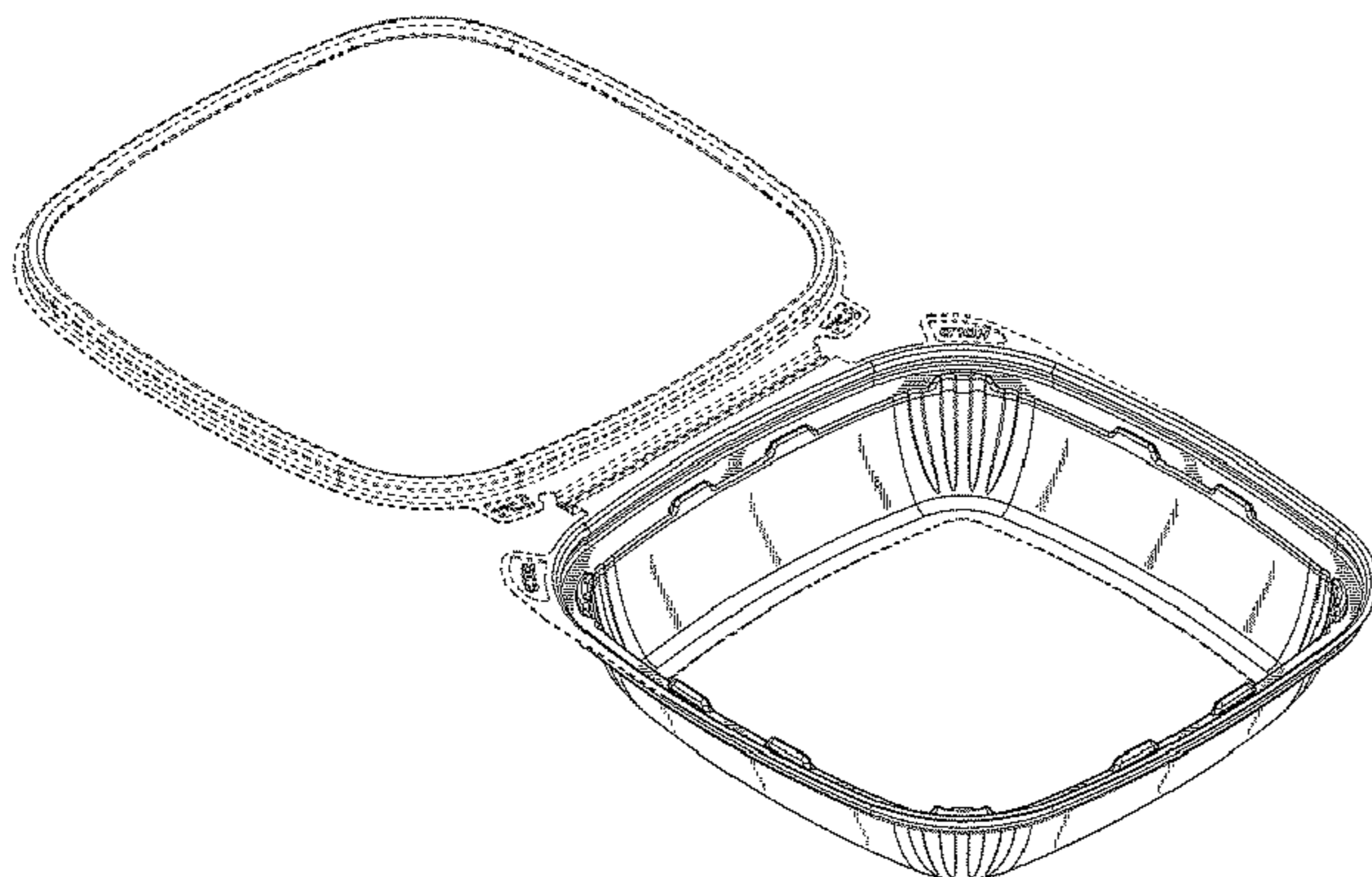

(56)

References Cited

U.S. PATENT DOCUMENTS

D588,417 S 3/2009 Doliwa  
 D609,532 S \* 2/2010 Koennecke ..... D7/584  
 D664,428 S \* 7/2012 Rivera ..... D9/426  
 D668,536 S \* 10/2012 Sanfilippo ..... D9/425  
 D675,517 S \* 2/2013 Garza ..... D9/424  
 8,371,468 B2 2/2013 Sellari et al.  
 D749,412 S \* 2/2016 Hu ..... D9/426  
 D756,770 S \* 5/2016 Snedden ..... D9/425  
 9,475,621 B1 \* 10/2016 Krueger ..... B65D 43/0254  
 9,580,234 B2 2/2017 Lam  
 9,630,756 B2 4/2017 Sellari et al.  
 9,676,527 B2 6/2017 McCumber  
 D795,057 S \* 8/2017 Segal ..... D9/425  
 D805,857 S \* 12/2017 Mei ..... D7/629  
 D848,258 S \* 5/2019 Mei ..... D9/429  
 D886,595 S \* 6/2020 Wouters ..... D9/426  
 D924,678 S \* 7/2021 Huang ..... D9/426  
 2005/0247709 A1 \* 11/2005 Atkins ..... B65D 1/36  
 220/4.23  
 2007/0045317 A1 \* 3/2007 Rosender ..... B65D 43/0249  
 220/4.23  
 2008/0135556 A1 \* 6/2008 Bontrager ..... B65D 1/34  
 220/675  
 2008/0308557 A1 12/2008 Kyle et al.  
 2010/0282752 A1 11/2010 Lam  
 2011/0000929 A1 \* 1/2011 Brown ..... B65D 43/162  
 220/810  
 2014/0217100 A1 8/2014 Nazareth et al.

2016/0101892 A1 4/2016 Wichmann et al.  
 2019/0291927 A1 9/2019 Farach  
 2020/0115117 A1 4/2020 Tsertsvadze

OTHER PUBLICATIONS

Food Grade Disposable Plastic Box Food. [online] Retrieved Jun. 28, 2022 from URL: [https://www.hihstore.com/?product\\_id=8962671\\_30](https://www.hihstore.com/?product_id=8962671_30) (Year: 2022).\*

Choice 8 oz. Clear RPET Hinged Deli Container. [online] Retrieved Jun. 28, 2022 from URL: <https://www.webstaurantstore.com/choice-8-oz-clear-rpet-hinged-deli-container-pack/999CH08.html> (Year: 2022).\*

Disposable Plastic Clamshell Food Containers. [online] Retrieved Jun. 28, 2022 from URL: <https://www.amazon.com/Stock-Your-Home-Plastic-Clamshell/dp/B0892QS6Q8> (Year: 2022).\*

“Disclosure of containers Placon SBL-48, MRP: 192087, and Placon fs1-48, MRP: 166246,” Placon Corporation, Madison, WI. On sale at least as early as May 25, 2020.

Fresh 'N Clear® Bowls and Trays Bowl Large, SKU:SBL-48B, Placon Corporation, Madison, WI. [https://www.placon.com/products/food-packaging/fresh-n-clear/bowls-and-trays/fresh-n-clear-bowls-and-trays-clear-bowl-large/?attribute\\_pa\\_volume=48-oz&attribute\\_pa\\_color=clear](https://www.placon.com/products/food-packaging/fresh-n-clear/bowls-and-trays/fresh-n-clear-bowls-and-trays-clear-bowl-large/?attribute_pa_volume=48-oz&attribute_pa_color=clear) downloaded May 25, 2021.

Fresh 'N Clear® Selectables™ 9" Base, SKU: FS1-32 Clear, MRP#: 166386, Placon Corporation, Madison, WI. <https://www.placon.com/products/food-packaging/fresh-n-clear/selectables/fresh-n-clear-selectables-9%E2%80%B3-base/> Downloaded May 25, 2021.

\* cited by examiner

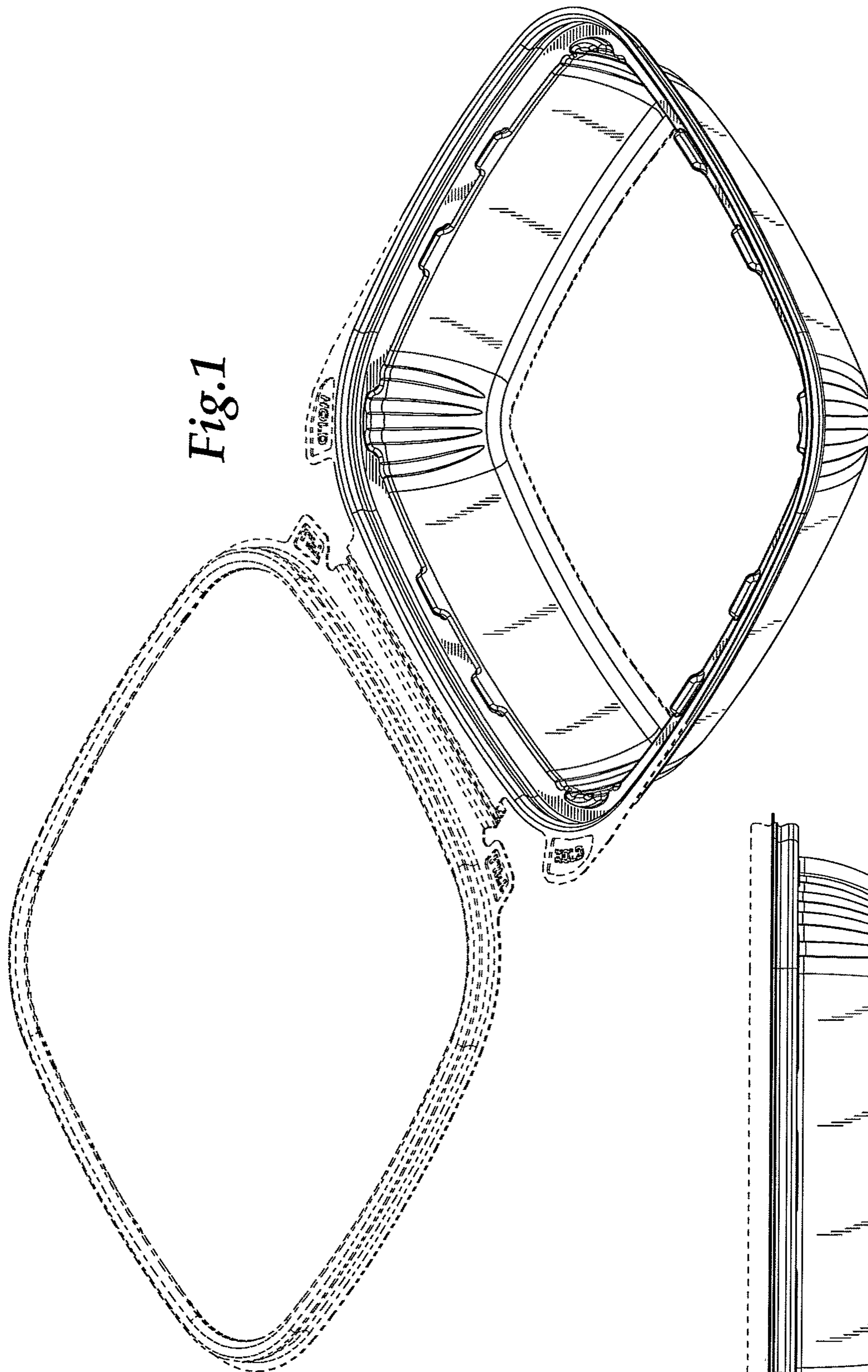

*Fig. 1*

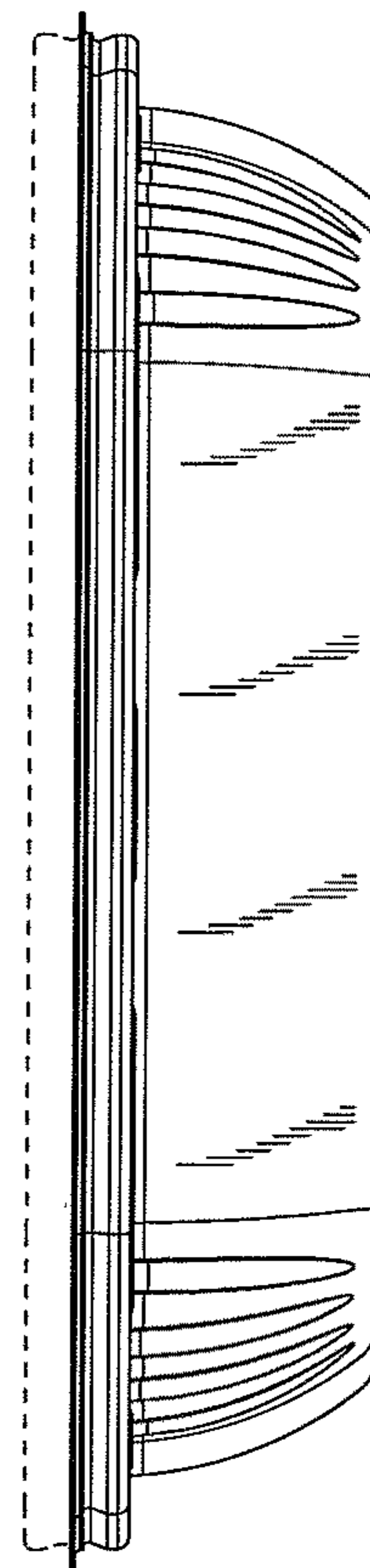

*Fig. 2*

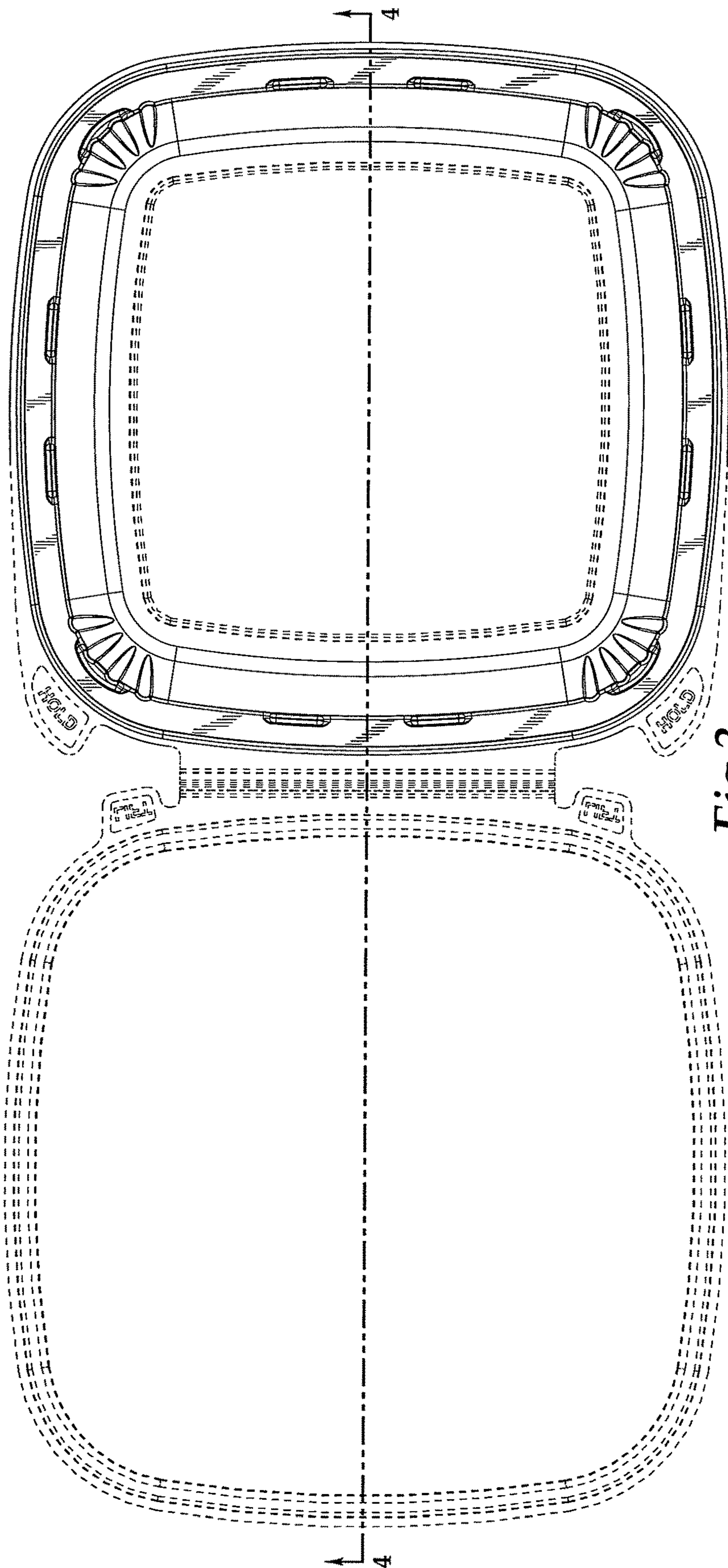

Fig.3

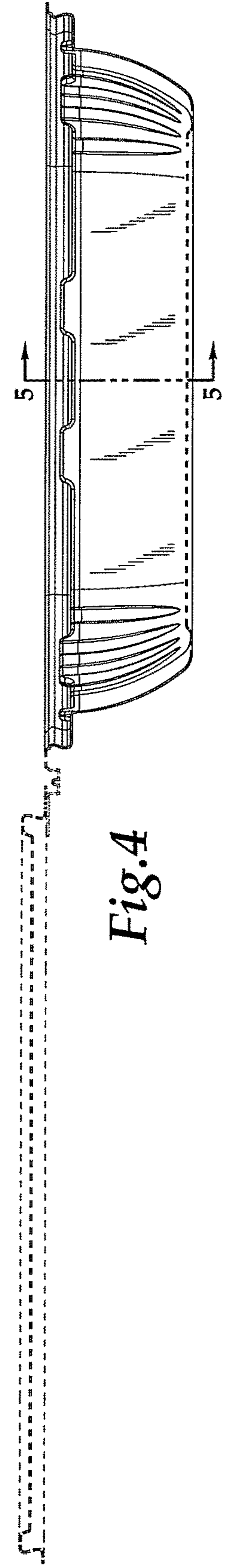

Fig.4

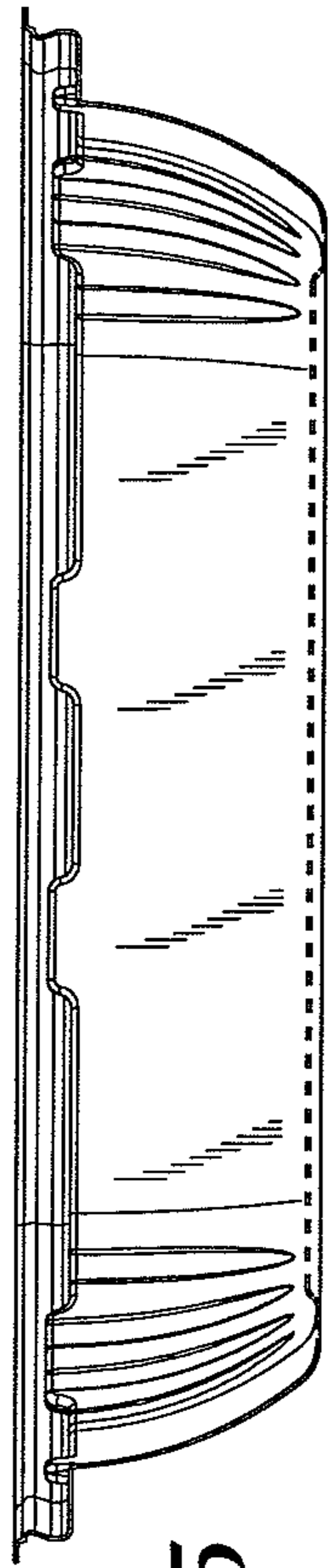

Fig. 5

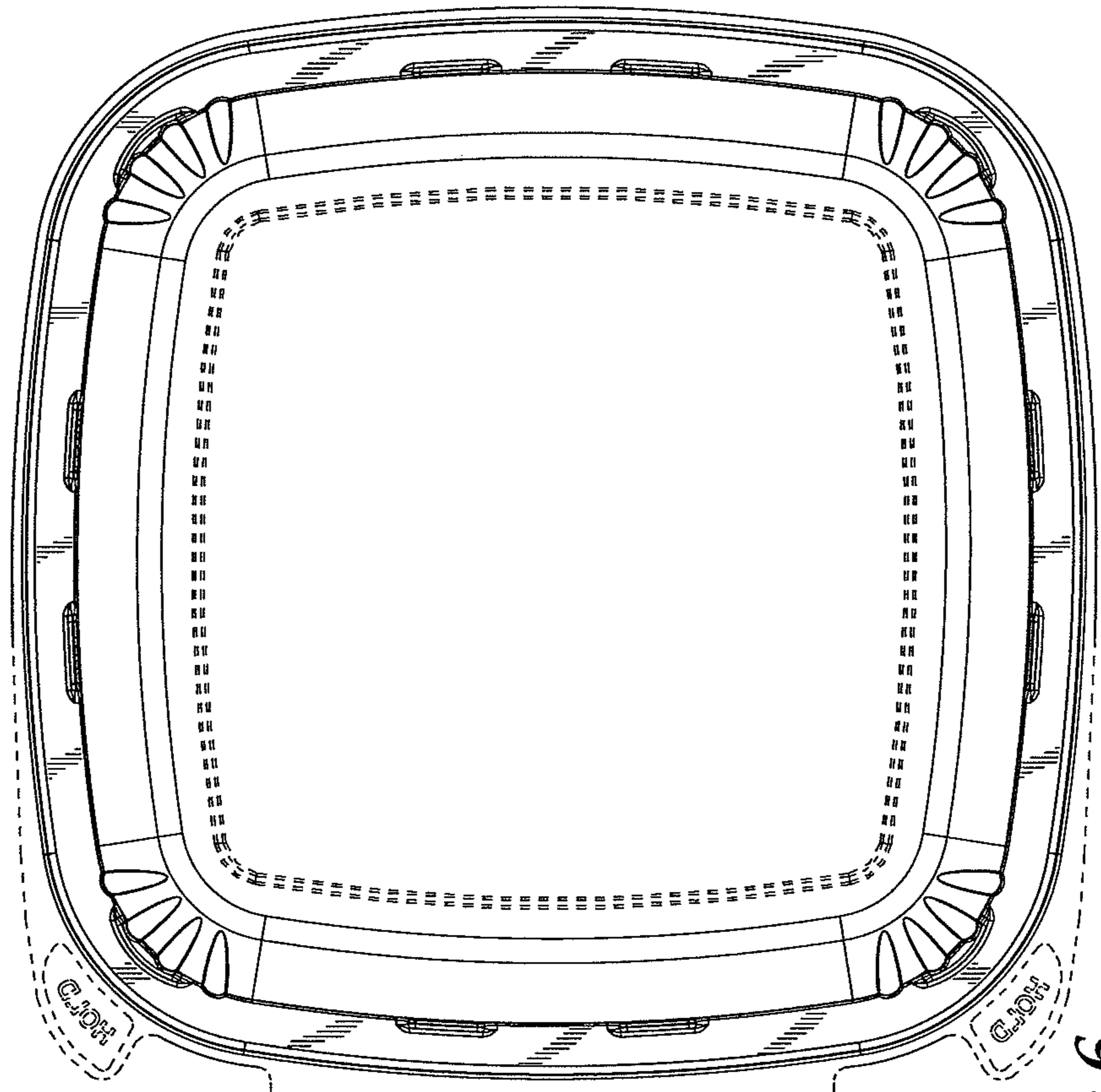
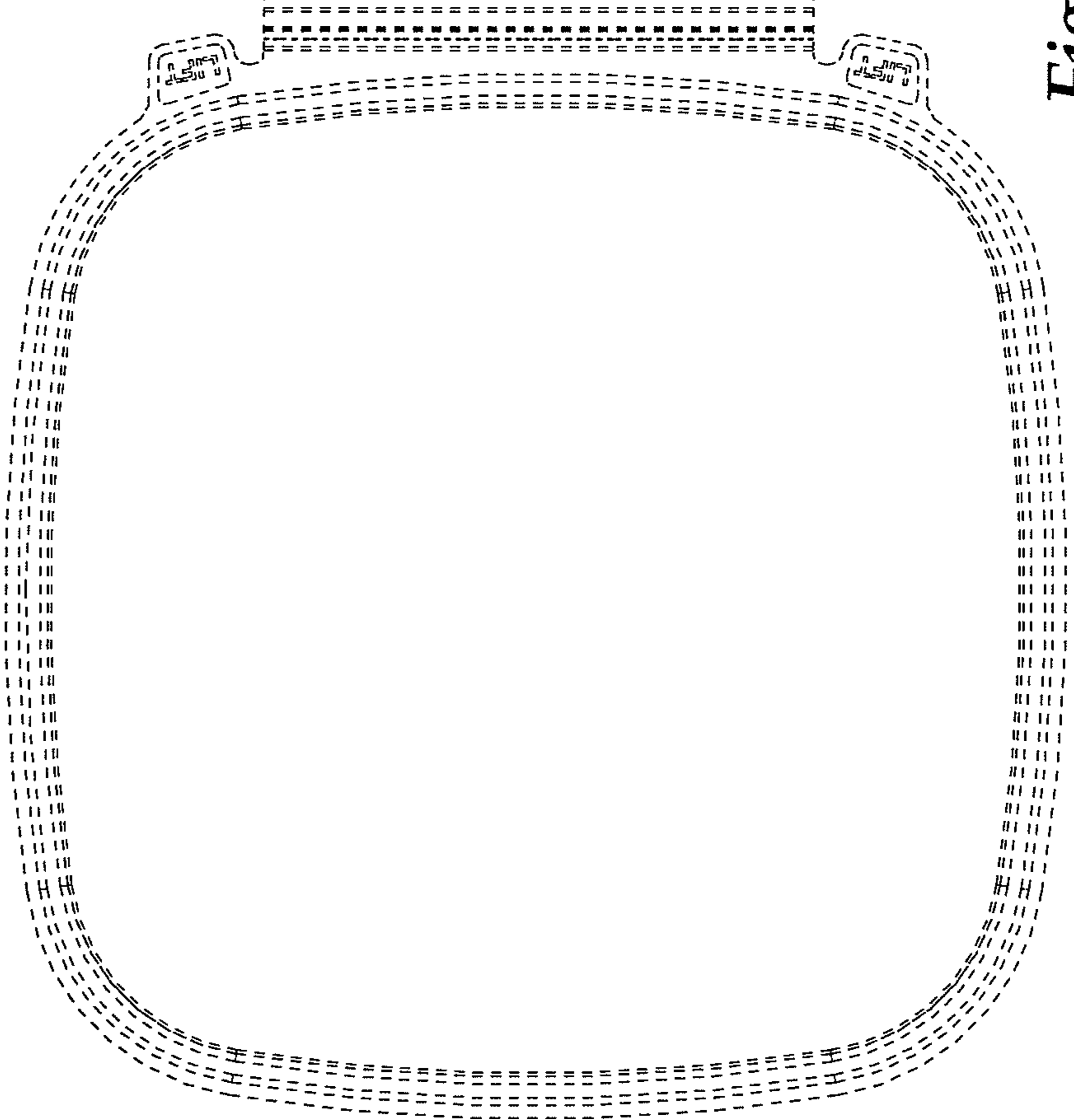
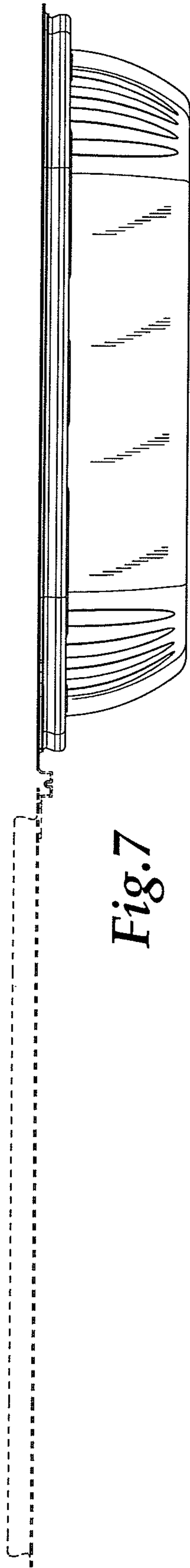
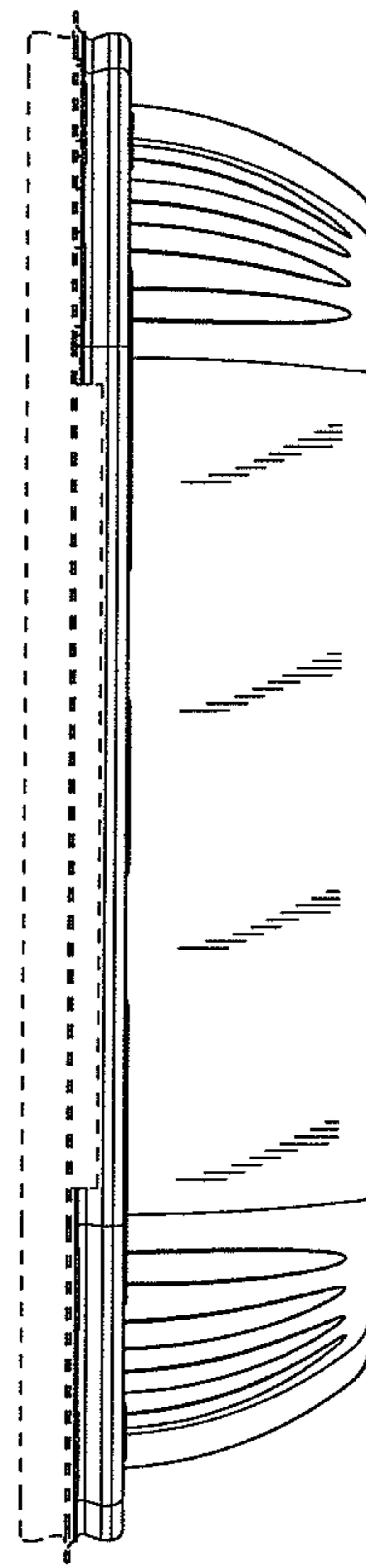

Fig. 6





*Fig. 7*



*Fig. 8*

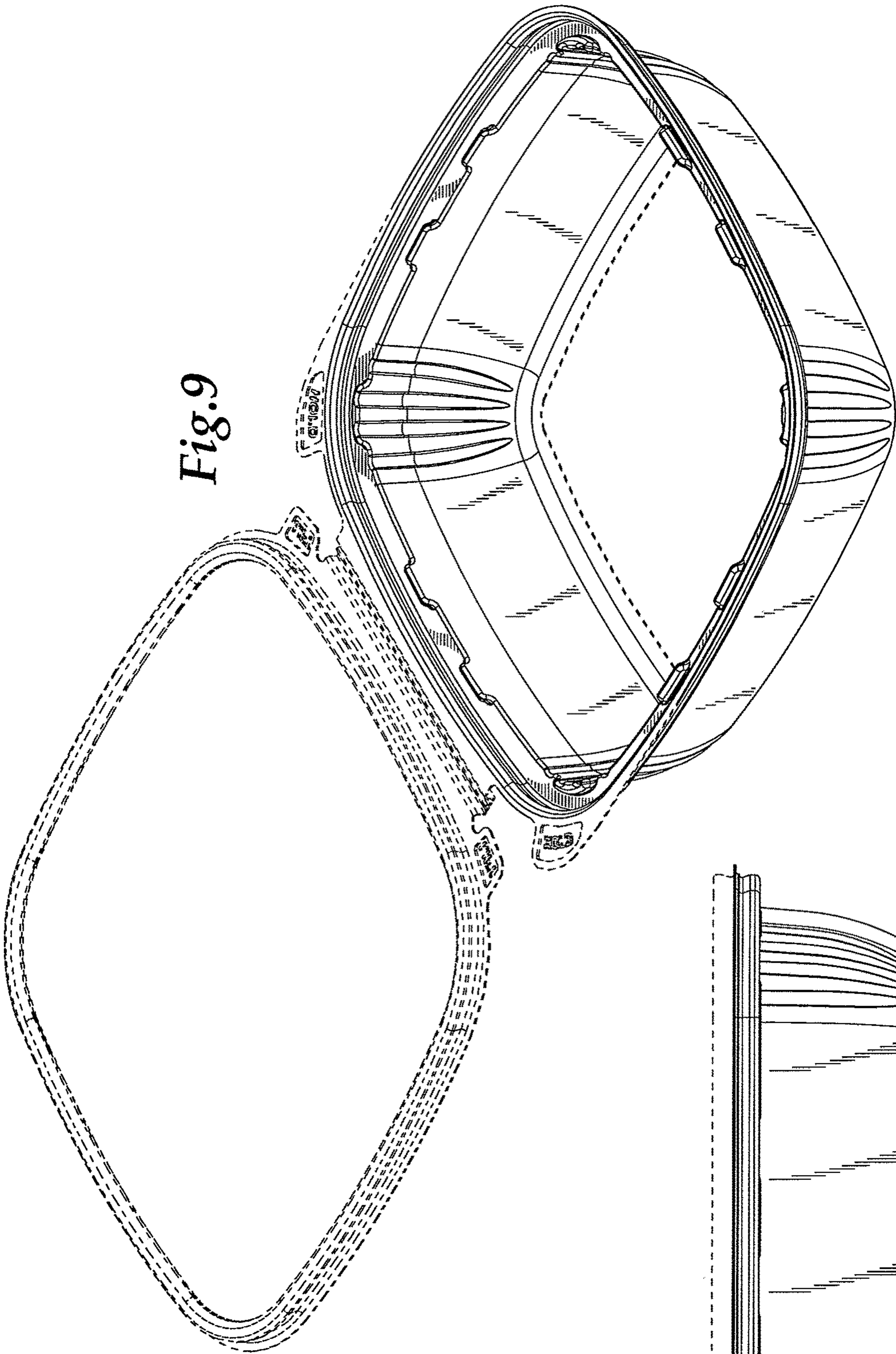

Fig.9

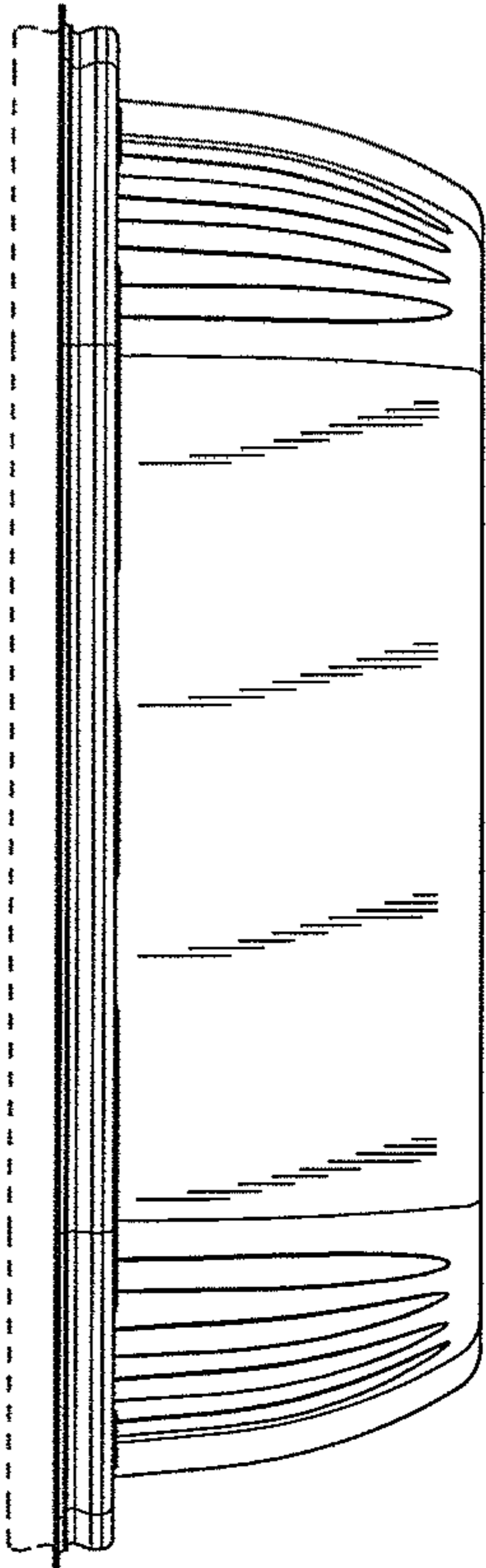

Fig.10

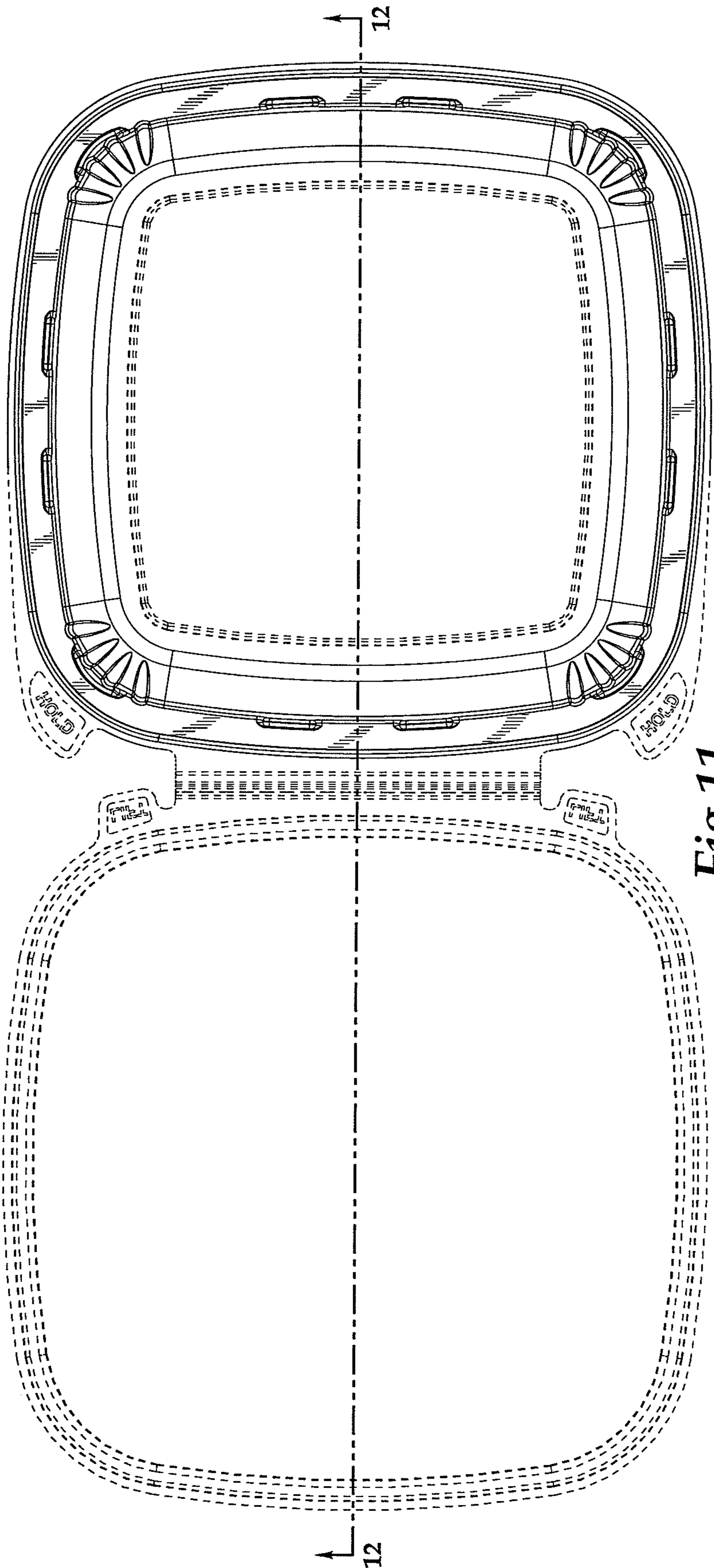

Fig. 11

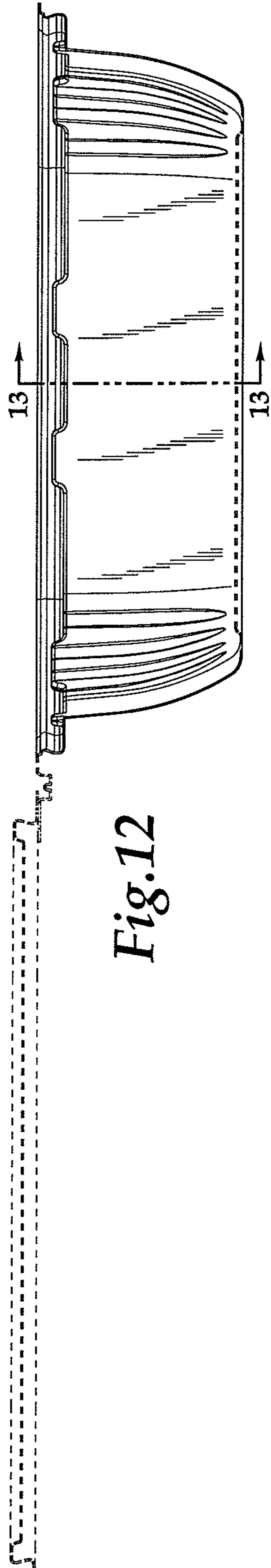

Fig. 12



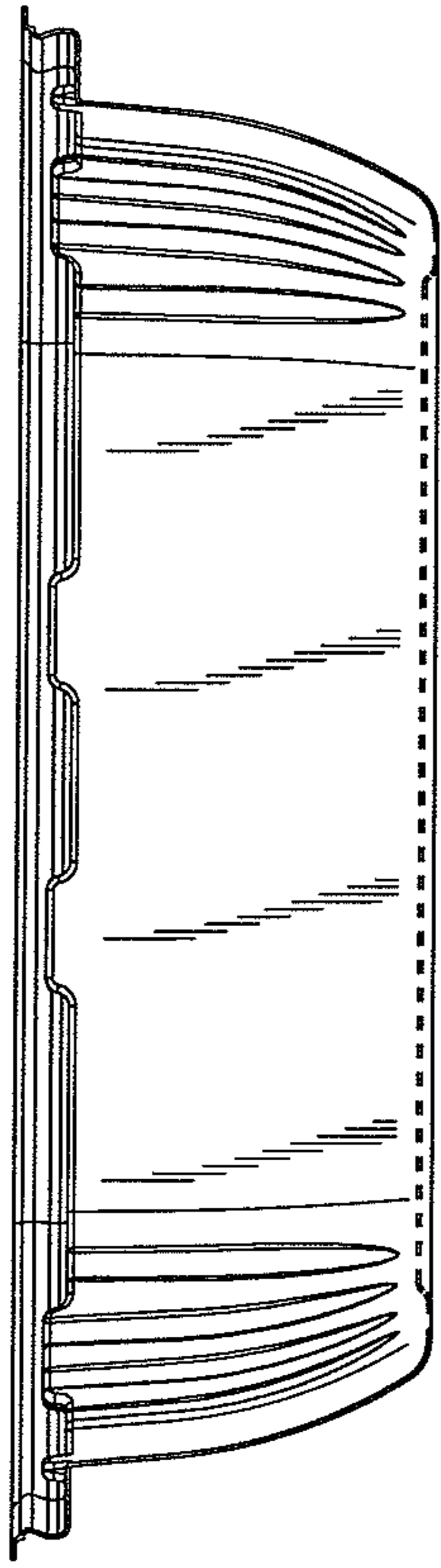

Fig. 13

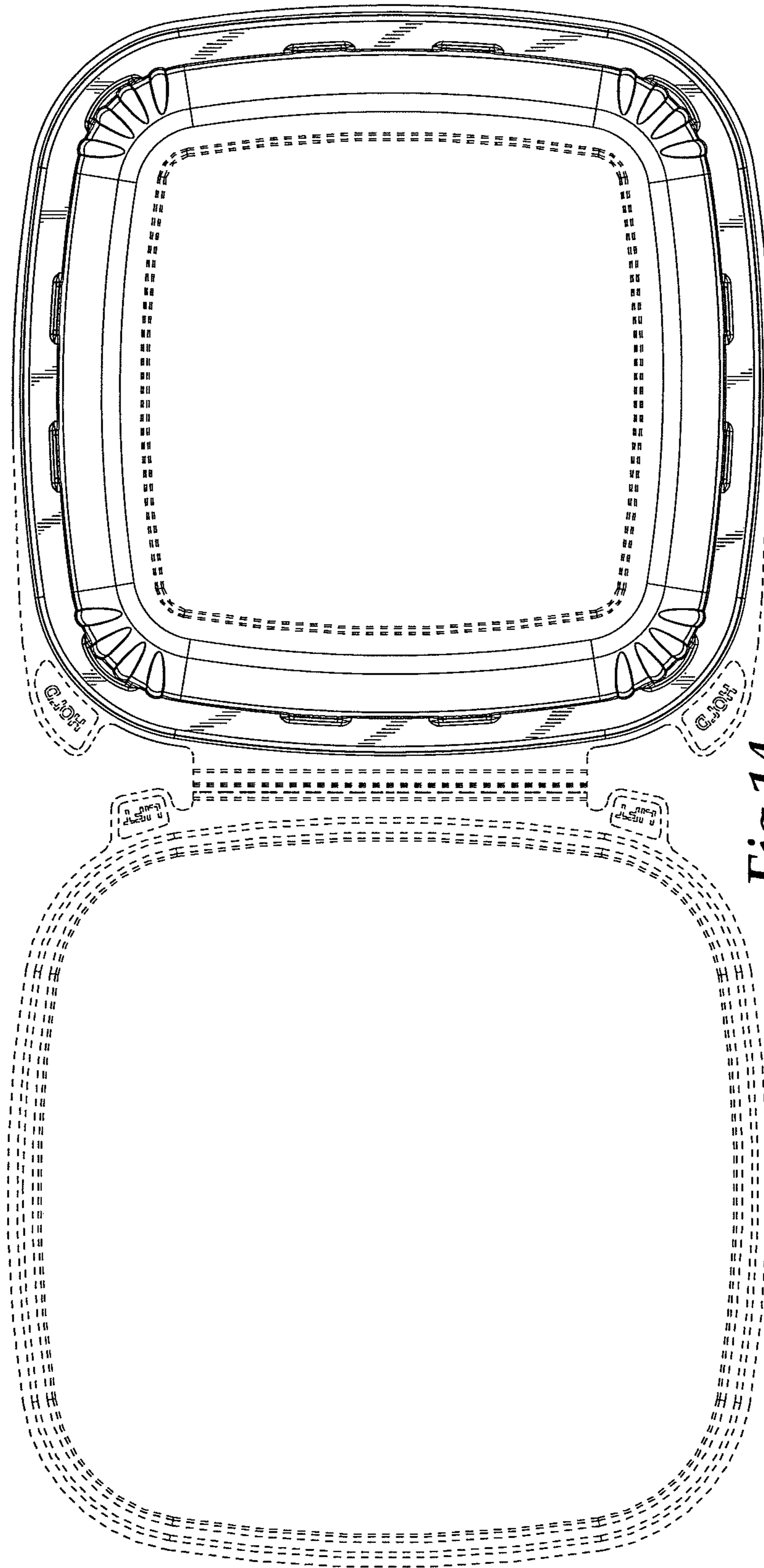
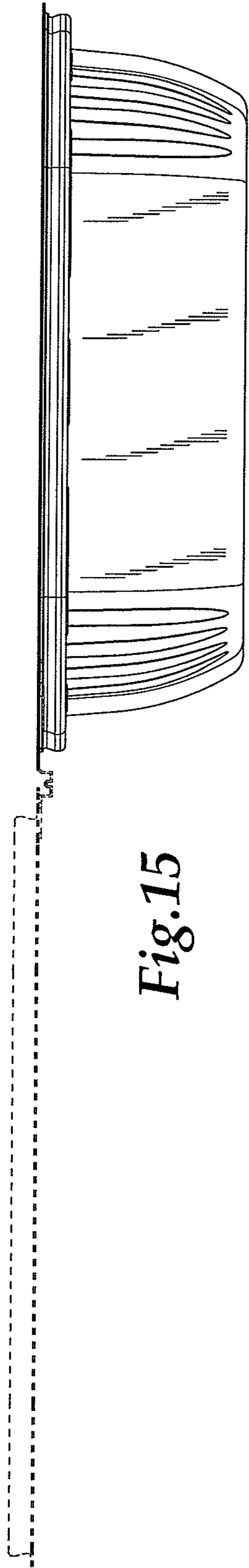
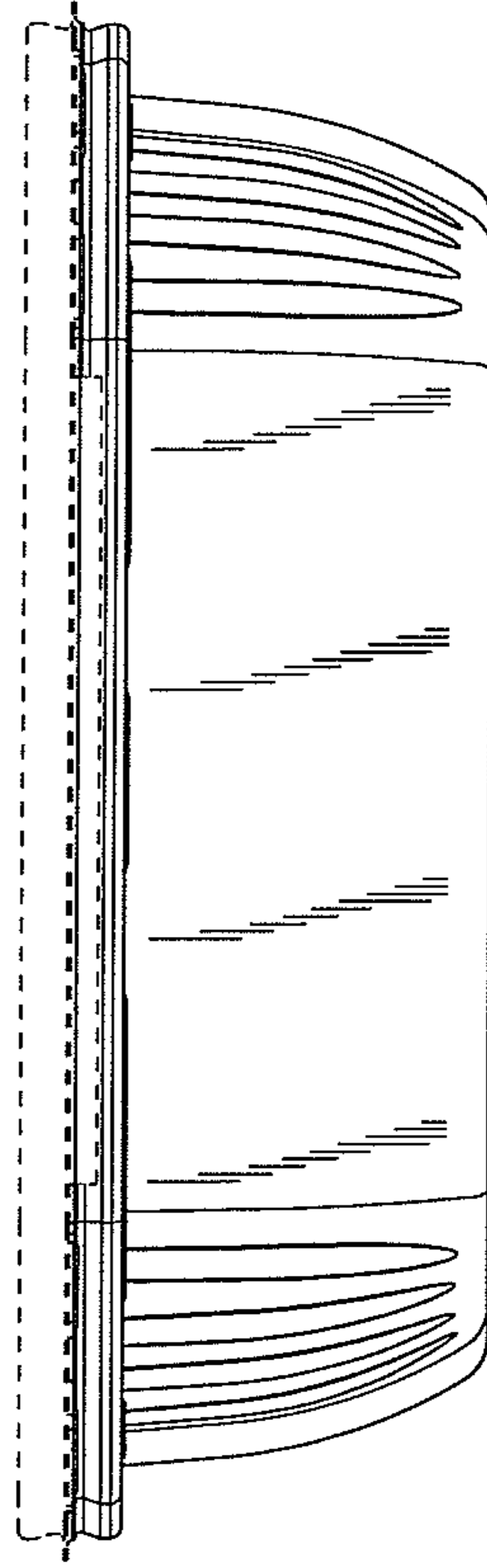

Fig. 14



*Fig. 15*



*Fig. 16*