

US00D964159S

(12) **United States Design Patent**
Kos et al.

(10) **Patent No.:** **US D964,159 S**

(45) **Date of Patent:** **** Sep. 20, 2022**

(54) **PACKAGING FOR A PLURALITY OF PRODUCTS**

(71) Applicants: **Jan Kos**, Orcas Island, WA (US);
Julien Kos, Orcas Island, WA (US)

(72) Inventors: **Jan Kos**, Orcas Island, WA (US);
Julien Kos, Orcas Island, WA (US)

(**) Term: **15 Years**

(21) Appl. No.: **29/723,601**

(22) Filed: **Feb. 7, 2020**

(51) **LOC (13) Cl.** **09-03**

(52) **U.S. Cl.**
USPC **D9/418; D9/420**

(58) **Field of Classification Search**
USPC D9/414-419, 337, 346, 433, 515, 518,
D9/707, 734, 421, 420, 427, 432, 430,
D9/499; D11/142, 143, 144, 145, 155;
D6/515, 518; D10/61, 64; D19/37, 39,
D19/40, 101-103
CPC B65D 2575/54; B65D 2575/58; B65D
5/2047; B65D 5/28; B65D 73/0085;
B65D 75/522; B65D 77/2024
See application file for complete search history.

(56) **References Cited**

U.S. PATENT DOCUMENTS

- 1,906,555 A * 5/1933 Donnell G09F 5/042
206/472
- 2,239,145 A * 4/1941 Doner G09F 5/042
206/232
- D156,974 S * 1/1950 Knowles D19/106
- 2,574,998 A * 11/1951 Bangert, Jr. B65D 5/28
220/62
- 2,833,457 A * 5/1958 Tyrseck B65D 5/524
229/164
- 3,436,832 A * 4/1969 Juberigan E04G 21/1825
33/410
- 3,514,875 A * 6/1970 Howard B21D 1/08
206/472
- D237,691 S * 11/1975 Black D10/64
- D238,662 S * 2/1976 Black D10/64

- D238,761 S * 2/1976 Black D10/64
- D260,076 S * 8/1981 Schillinger 206/426
- D281,173 S * 10/1985 Bloom D19/37
- D345,512 S * 3/1994 Gaenzle D10/64
- D359,900 S * 7/1995 Hawthorne D9/415
- D389,054 S * 1/1998 Teags D9/431
- D393,591 S * 4/1998 Baryshyan D9/753
- 6,186,327 B1 * 2/2001 Hadden G09F 5/04
206/472
- 6,253,922 B1 * 7/2001 Hadden G09F 5/04
206/472
- 6,283,566 B1 * 9/2001 Doces A47B 81/04
211/71.01
- D458,128 S * 6/2002 Gray D9/432
- D471,826 S * 3/2003 Rosenstein D10/64
- D476,116 S * 6/2003 Cohen D28/83
- D493,055 S * 7/2004 Ferretti D6/552
- D511,465 S * 11/2005 Smith D9/732
- D645,347 S * 9/2011 Liebowitz D9/435
- D646,163 S * 10/2011 Liebowitz D9/435
- D657,267 S * 4/2012 Meijer D10/64
- D659,019 S * 5/2012 Specker D9/732
- D684,482 S * 6/2013 Stevens D9/732
- D703,527 S * 4/2014 Fuller D9/418
- D728,358 S * 5/2015 Belamich D9/420
- D758,191 S * 6/2016 Tu D9/456
- 9,394,075 B1 * 7/2016 Kobbe B65D 5/2057
- D766,713 S * 9/2016 Kiss D9/421
- D831,478 S * 10/2018 Moon D9/432
- D844,428 S * 4/2019 Stadelmaier D9/415
- D851,510 S * 6/2019 Jans D10/71
- D874,919 S * 2/2020 Choi D9/418
- D876,947 S * 3/2020 Choi D9/415
- D891,921 S * 8/2020 Davies D9/432
- D893,321 S * 8/2020 Smith D10/64
- D896,068 S * 9/2020 Hampton D9/737
- D906,840 S * 1/2021 O'Neill D9/737
- D907,996 S * 1/2021 Lee D9/432
- D913,784 S * 3/2021 O'Donnell D9/432
- D918,715 S * 5/2021 Natsume D9/432
- D923,089 S * 6/2021 Zheng D19/103
- D924,643 S * 7/2021 Li D7/701
- 2021/0245943 A1 * 8/2021 Kos B65D 73/0092

OTHER PUBLICATIONS

3-Gang and 4-Gang Duplex Outlet Wall Plate. Brand: Enerlites. Publication date unavailable. Visited Sep. 21, 2021. URL: <https://www.beeslighting.com/8824-W> (Year: 0).*

4-Gang and 3-Gang Decorator/Rocker Wall Plate. Brand: Leviton. Publication date Jul. 26, 2018. Visited Sep. 21, 2021. URL: <https://www.homedepot.com/p/Leviton-White-4-Gang-Decorator-Rocker-Wall-Plate-1-Pack-R52-PJ264-00W/202059800> (Year: 2018).*

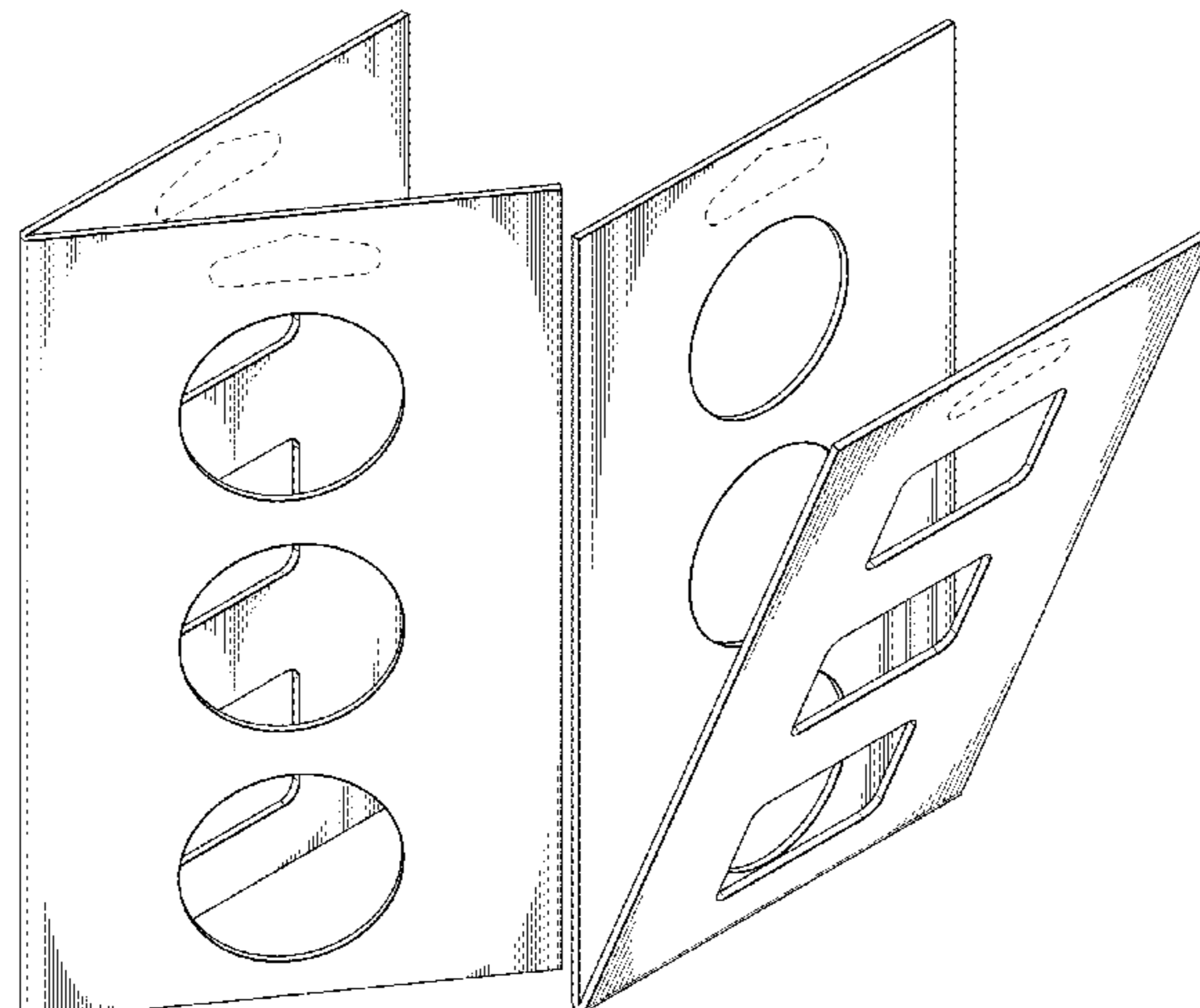

Slimline Masking Circles & Squares Stencil Set. Publication date unavailable. Visited Oct. 1, 2021. <https://www.newtonsnookdesigns.com/slimline-masking-circles-squares-stencil-set/> (Year: 0).*

* cited by examiner

Primary Examiner — Darcey E Gottschalk
Assistant Examiner — Vanessa M. Pursley
 (74) *Attorney, Agent, or Firm* — Christensen O'Connor Johnson Kindness PLLC

(57) **CLAIM**

The ornamental design for a packaging system for a plurality of products, as shown and described.

DESCRIPTION

FIG. 1 is a front view of the packaging for a plurality of products, in accordance with the new design;
 FIG. 2 is a rear view of the packaging for a plurality of products of FIG. 1;
 FIG. 3 is a top view of the packaging for a plurality of products of FIG. 1;
 FIG. 4 is a bottom view of the packaging for a plurality of products of FIG. 1;
 FIG. 5 is a left view of the packaging for a plurality of products of FIG. 1;
 FIG. 6 is a right view of the packaging for a plurality of products of FIG. 1;
 FIG. 7 is a front and left side perspective view of the packaging for a plurality of products of FIG. 1;
 FIG. 8 is a rear and right side perspective view of the packaging for a plurality of products of FIG. 1;
 FIG. 9 is another front view of the packaging for a plurality of products of FIG. 1;
 FIG. 10 is a front view of the packaging for a plurality of products, in accordance with another aspect of the new design;
 FIG. 11 is a rear view of the packaging for a plurality of products of FIG. 10;
 FIG. 12 is a top view of the packaging for a plurality of products of FIG. 10;
 FIG. 13 is a bottom view of the packaging for a plurality of products of FIG. 10;
 FIG. 14 is a left view of the packaging for a plurality of products of FIG. 10;
 FIG. 15 is a right view of the packaging for a plurality of products of FIG. 10;
 FIG. 16 is a front and right side perspective view of the packaging for a plurality of products of FIG. 10;
 FIG. 17 is a rear and right side perspective view of the packaging for a plurality of products of FIG. 10;
 FIG. 18 is another front view of the packaging for a plurality of products of FIG. 10;
 FIG. 19 is a front view of the packaging for a plurality of products, in accordance with another aspect of the new design;
 FIG. 20 is a rear view of the packaging for a plurality of products of FIG. 19;
 FIG. 21 is a top view of the packaging for a plurality of products of FIG. 19;
 FIG. 22 is a bottom view of the packaging for a plurality of products of FIG. 19;
 FIG. 23 is a left view of the packaging for a plurality of products of FIG. 19;

FIG. 24 is a right view of the packaging for a plurality of products of FIG. 19;
 FIG. 25 is a front and left side perspective view of the packaging for a plurality of products of FIG. 19;
 FIG. 26 is a rear and right side perspective view of the packaging for a plurality of products of FIG. 19;
 FIG. 27 is another front view of the packaging for a plurality of products of FIG. 19;
 FIG. 28 is a front view of the packaging for a plurality of products, in accordance with another aspect of the new design;
 FIG. 29 is a rear view of the packaging for a plurality of products of FIG. 28;
 FIG. 30 is a top view of the packaging for a plurality of products of FIG. 28;
 FIG. 31 is a bottom view of the packaging for a plurality of products of FIG. 28;
 FIG. 32 is a left view of the packaging for a plurality of products of FIG. 28;
 FIG. 33 is a right view of the packaging for a plurality of products of FIG. 28;
 FIG. 34 is a front and right side perspective view of the packaging for a plurality of products of FIG. 28;
 FIG. 35 is a rear and right side perspective view of the packaging for a plurality of products of FIG. 28;
 FIG. 36 is another front view of the packaging for a plurality of products of FIG. 28;
 FIG. 37 is a front view of the packaging for a plurality of products, in accordance with another aspect of the new design;
 FIG. 38 is a rear view of the packaging for a plurality of products of FIG. 37;
 FIG. 39 is a top view of the packaging for a plurality of products of FIG. 37;
 FIG. 40 is a bottom view of the packaging for a plurality of products of FIG. 37;
 FIG. 41 is a left view of the packaging for a plurality of products of FIG. 37;
 FIG. 42 is a right view of the packaging for a plurality of products of FIG. 37;
 FIG. 43 is a front and left side perspective view of the packaging for a plurality of products of FIG. 37;
 FIG. 44 is a rear and right side perspective view of the packaging for a plurality of products of FIG. 37;
 FIG. 45 is another front view of the packaging for a plurality of products of FIG. 37;
 FIG. 46 is a front view of the packaging for a plurality of products, in accordance with another aspect of the new design;
 FIG. 47 is a rear view of the packaging for a plurality of products of FIG. 46;
 FIG. 48 is a top view of the packaging for a plurality of products of FIG. 46;
 FIG. 49 is a bottom view of the packaging for a plurality of products of FIG. 46;
 FIG. 50 is a left view of the packaging for a plurality of products of FIG. 46;
 FIG. 51 is a right view of the packaging for a plurality of products of FIG. 46;
 FIG. 52 is a front and right side perspective view of the packaging for a plurality of products of FIG. 46;
 FIG. 53 is a rear and right side perspective view of the packaging for a plurality of products of FIG. 46; and,
 FIG. 54 is another front view of the packaging for a plurality of products of FIG. 46.

In the drawings, the broken lines show portions of a packaging for a plurality of products which form no part of the claim.

1 Claim, 36 Drawing Sheets

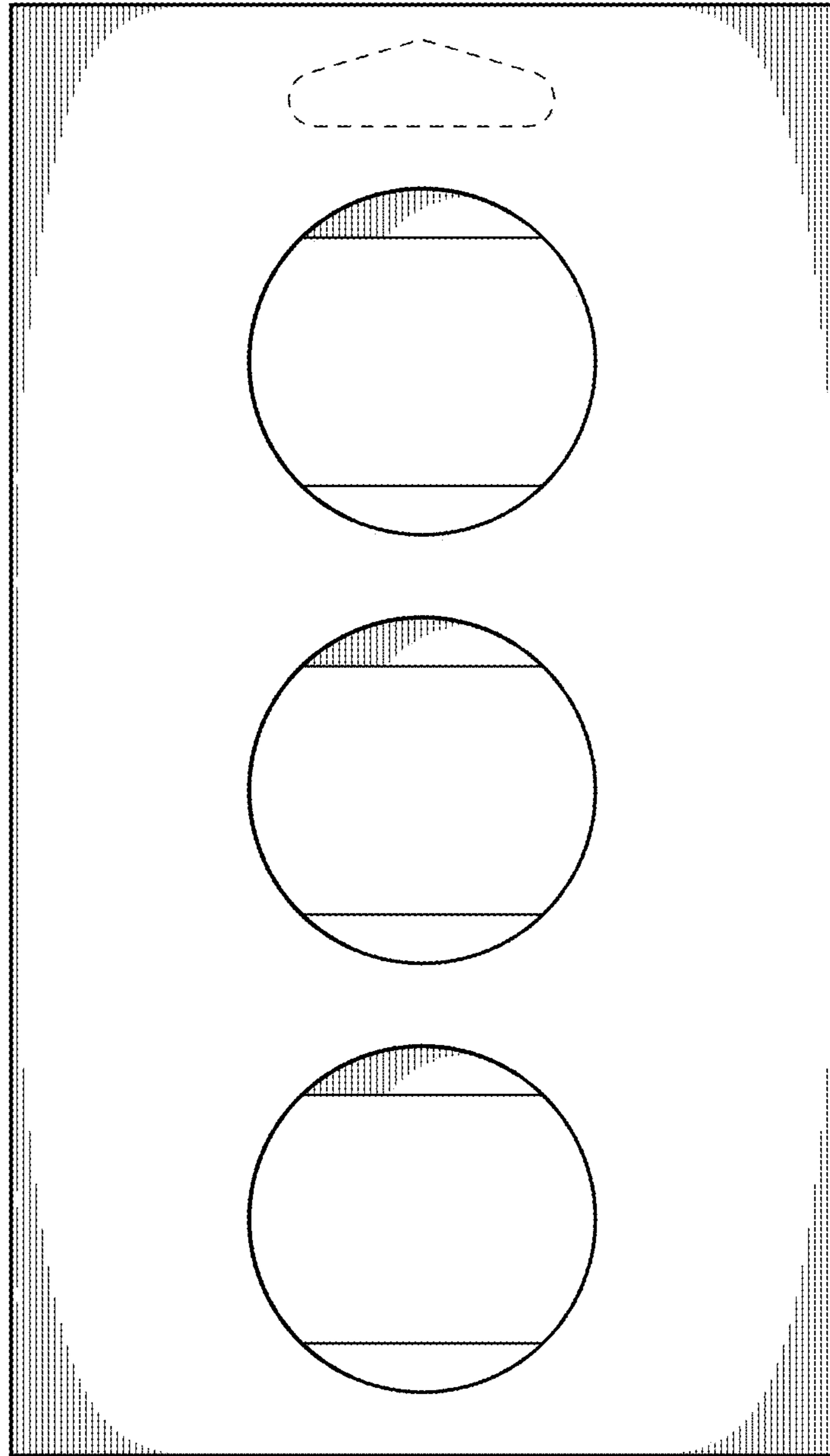

Fig. 1.

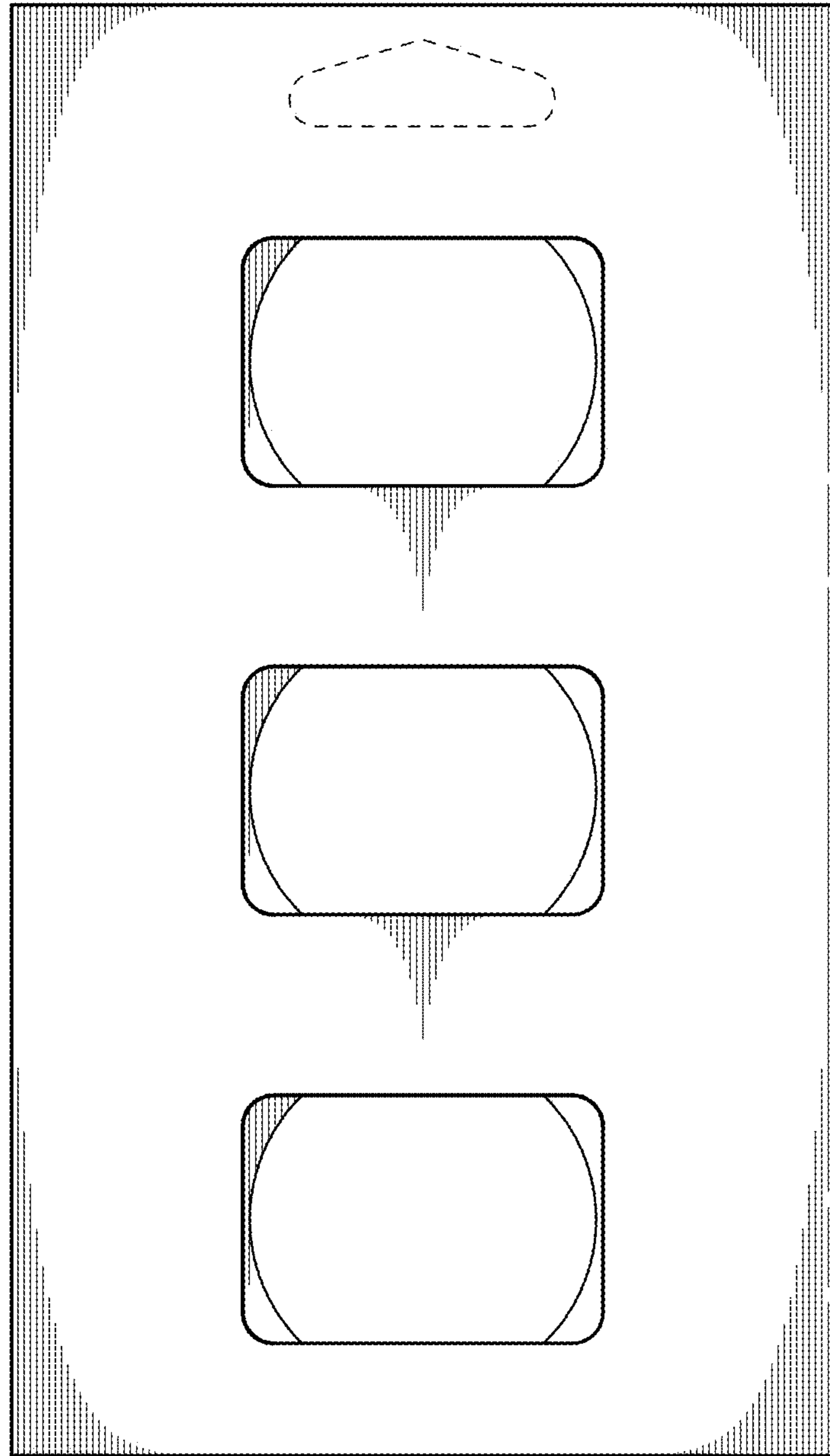

Fig. 2.



Fig.3.



Fig.5.

Fig.6.

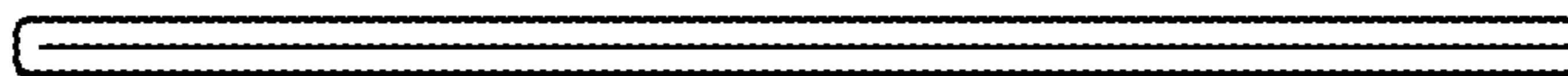

Fig.4.

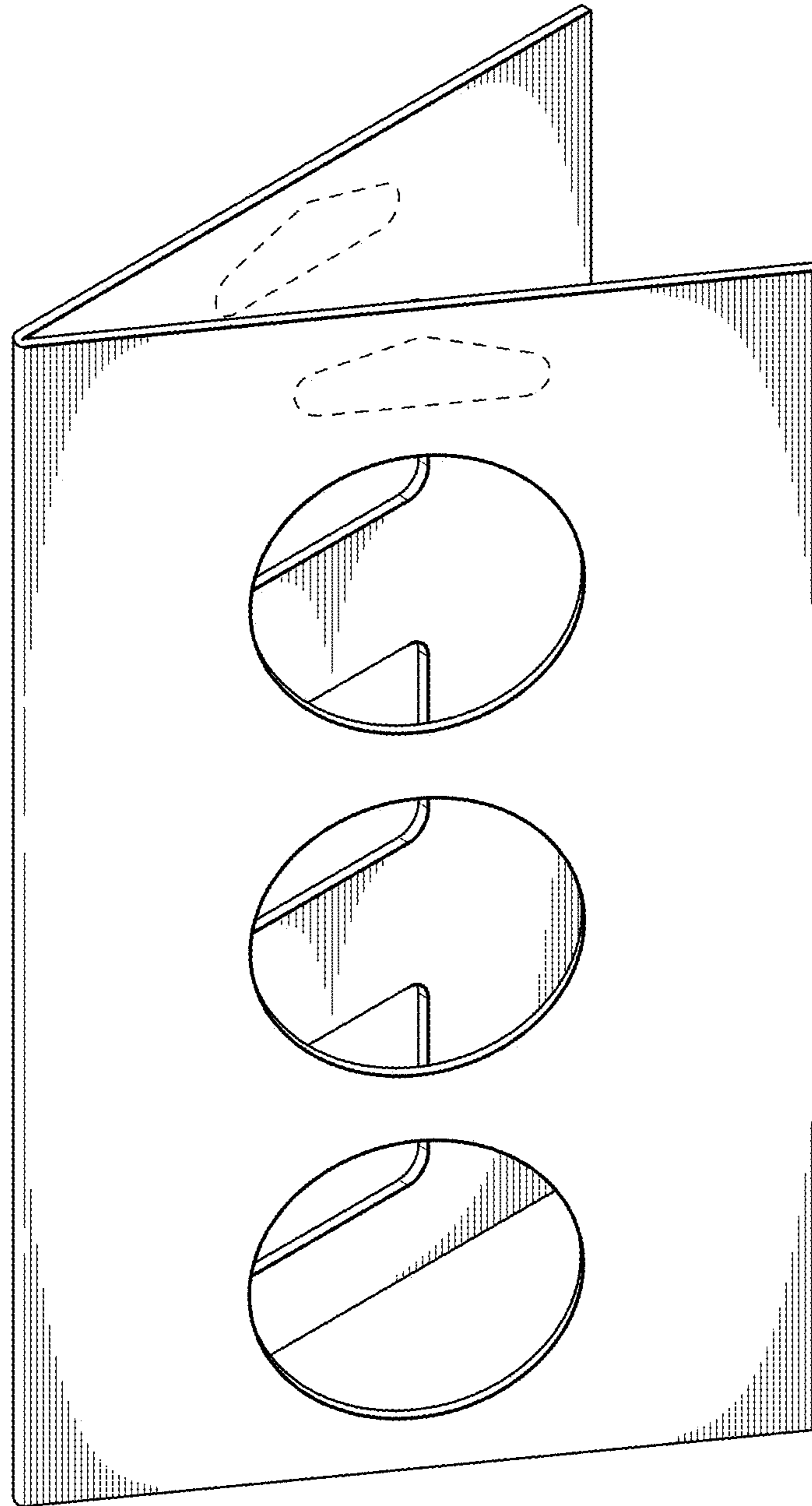

Fig. 7.

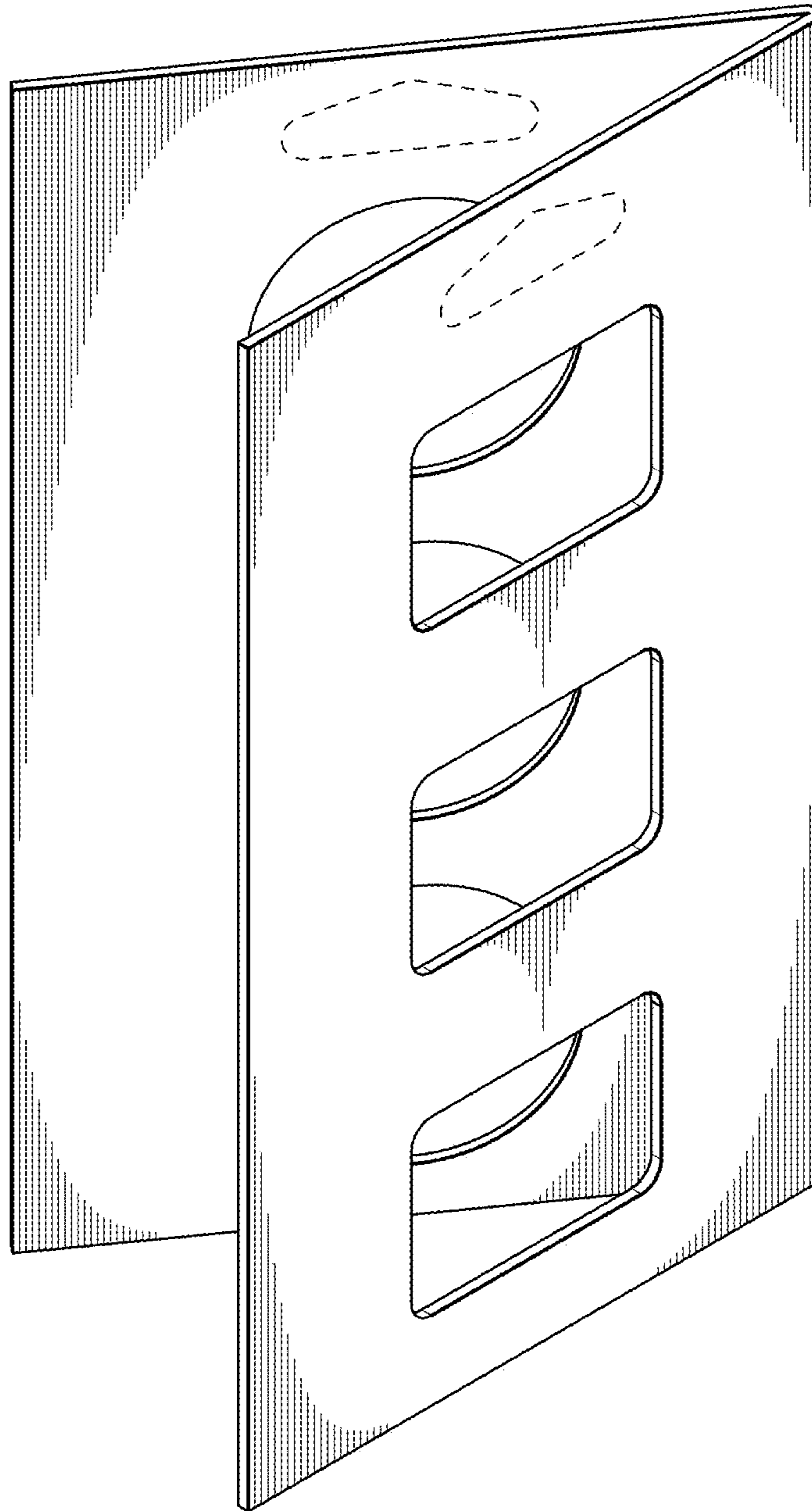
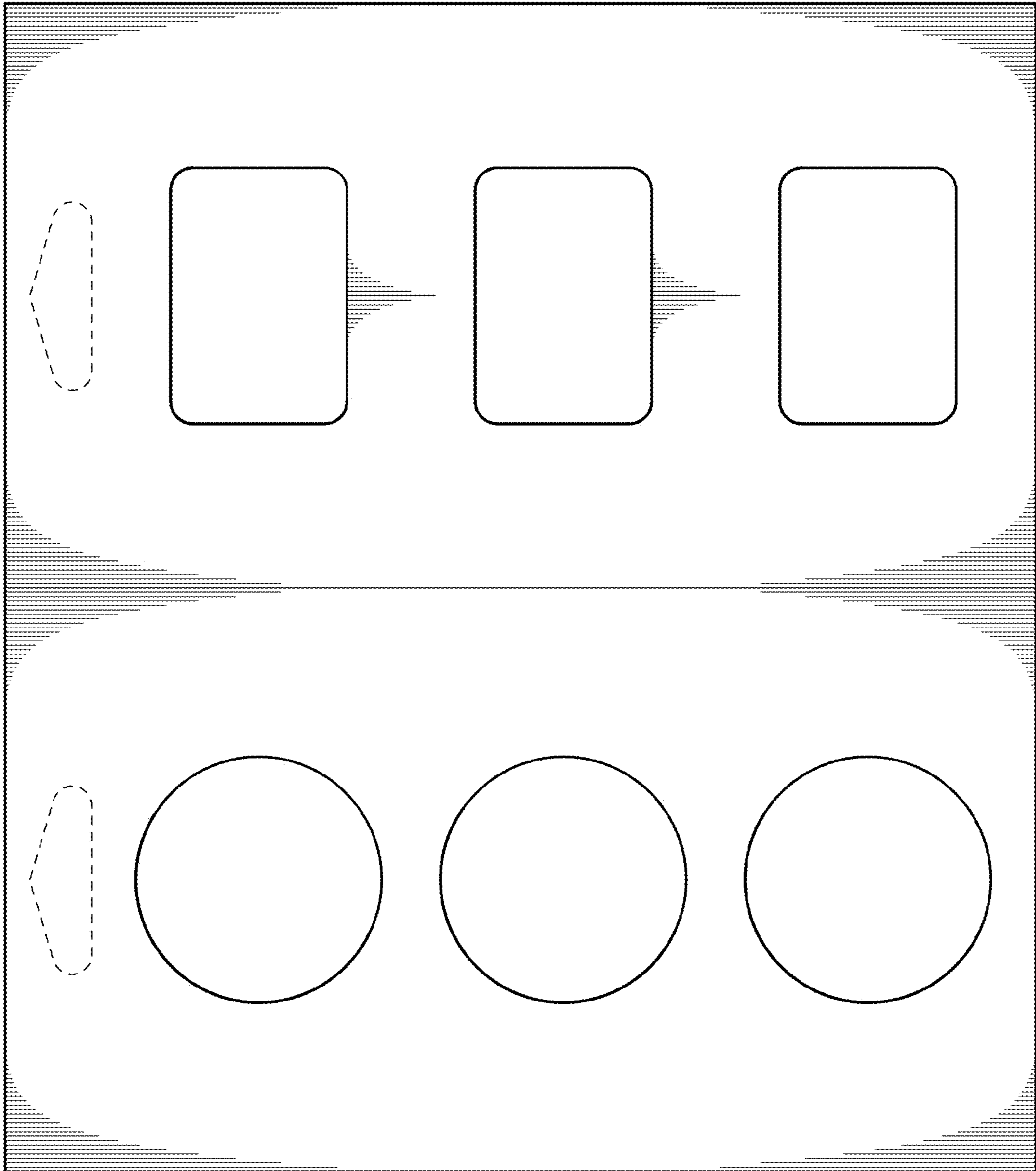

Fig. 8.

Fig. 9.



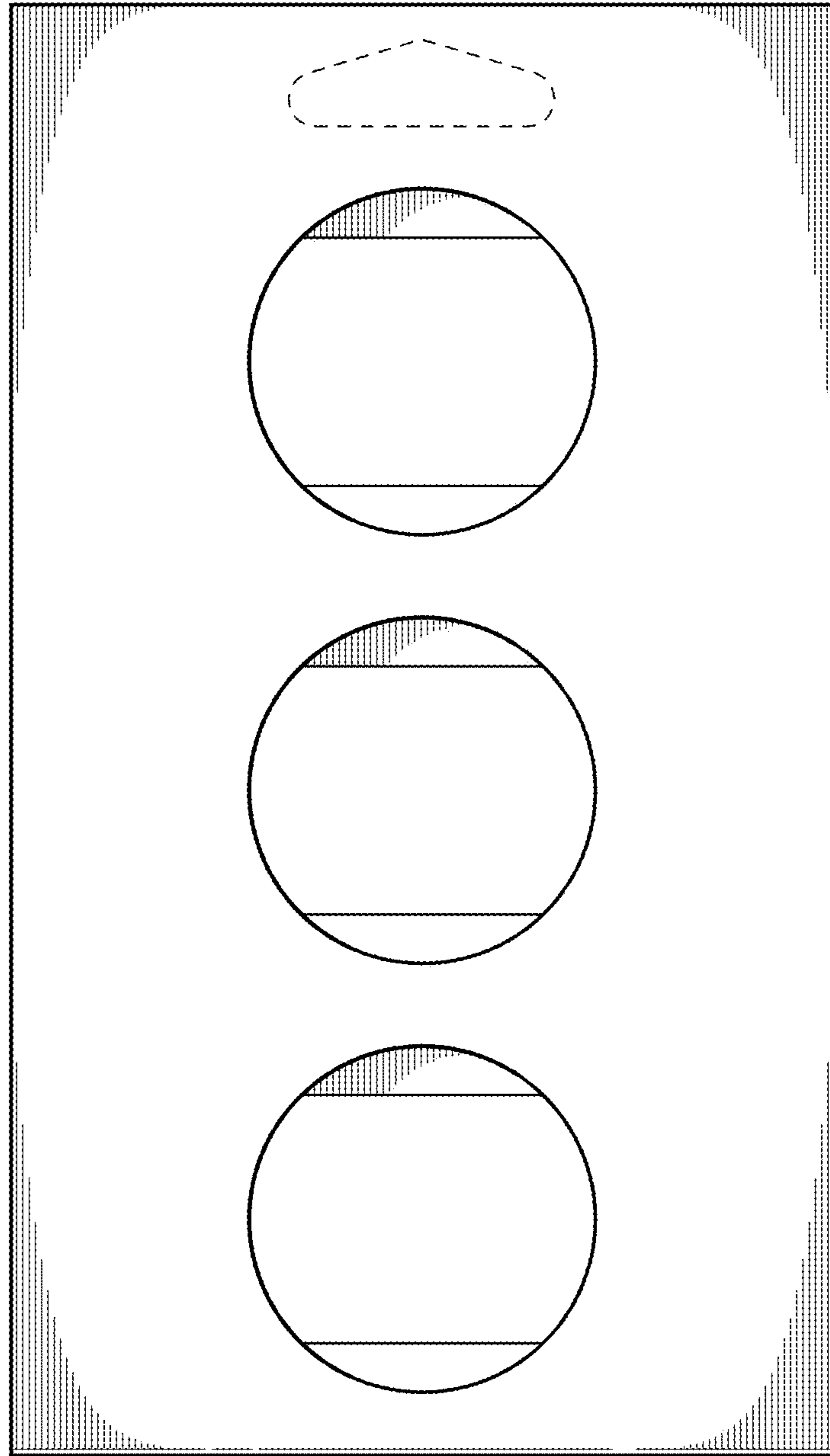

Fig. 10.

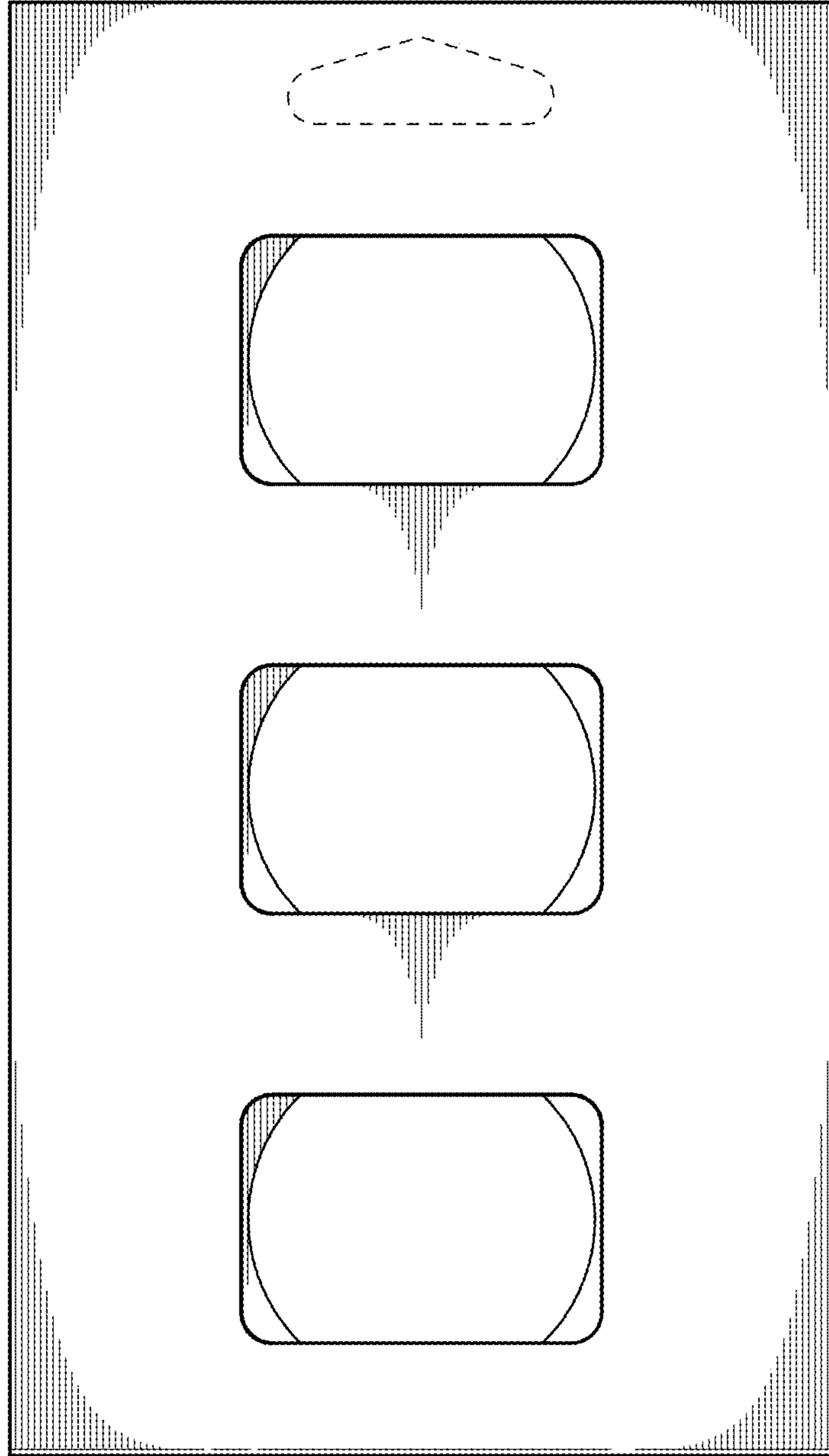

Fig. 11.



Fig. 12.



Fig. 14.

Fig. 15.

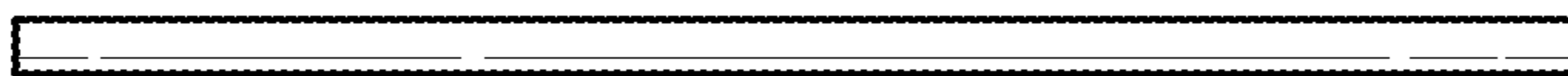

Fig. 13.

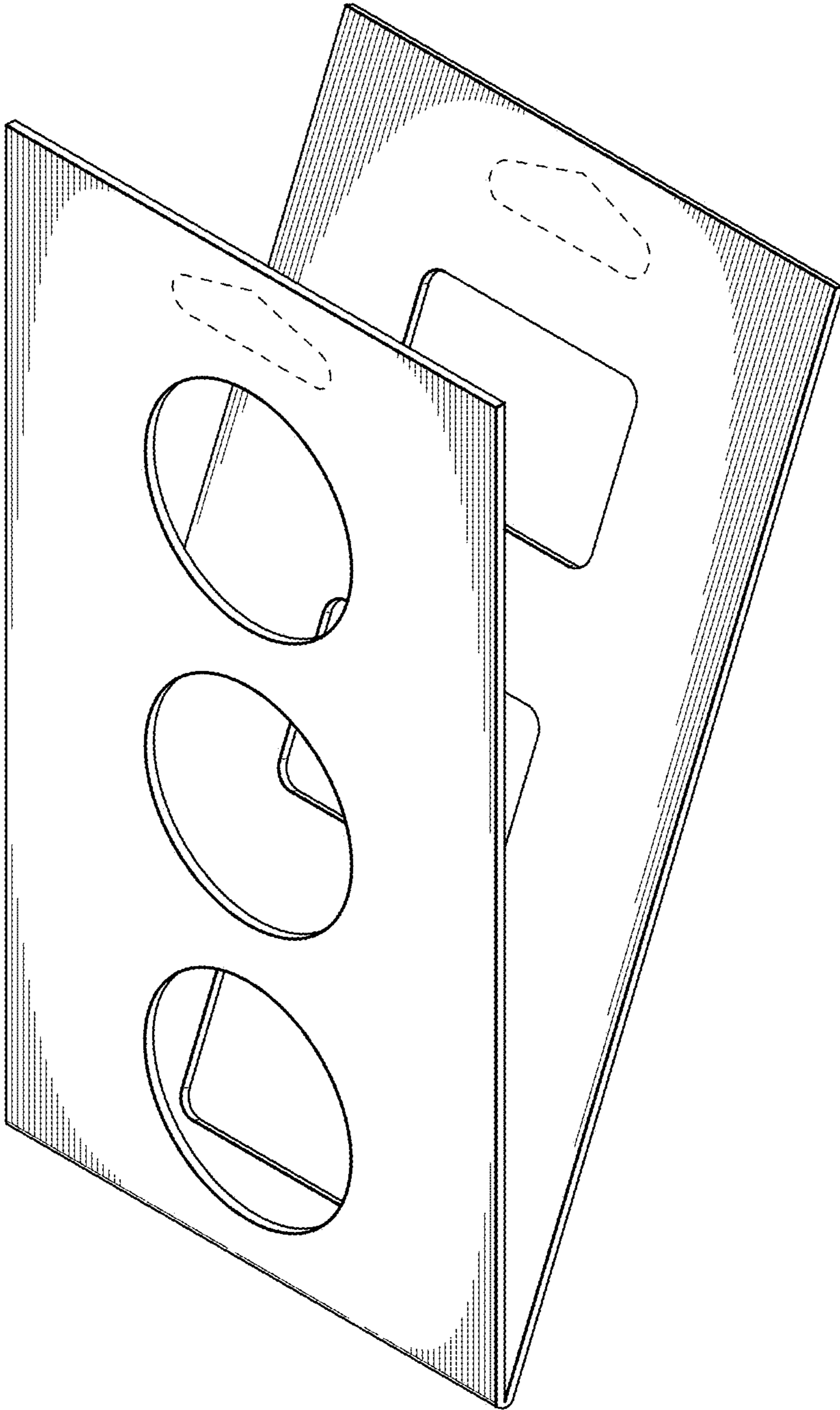

Fig. 16.

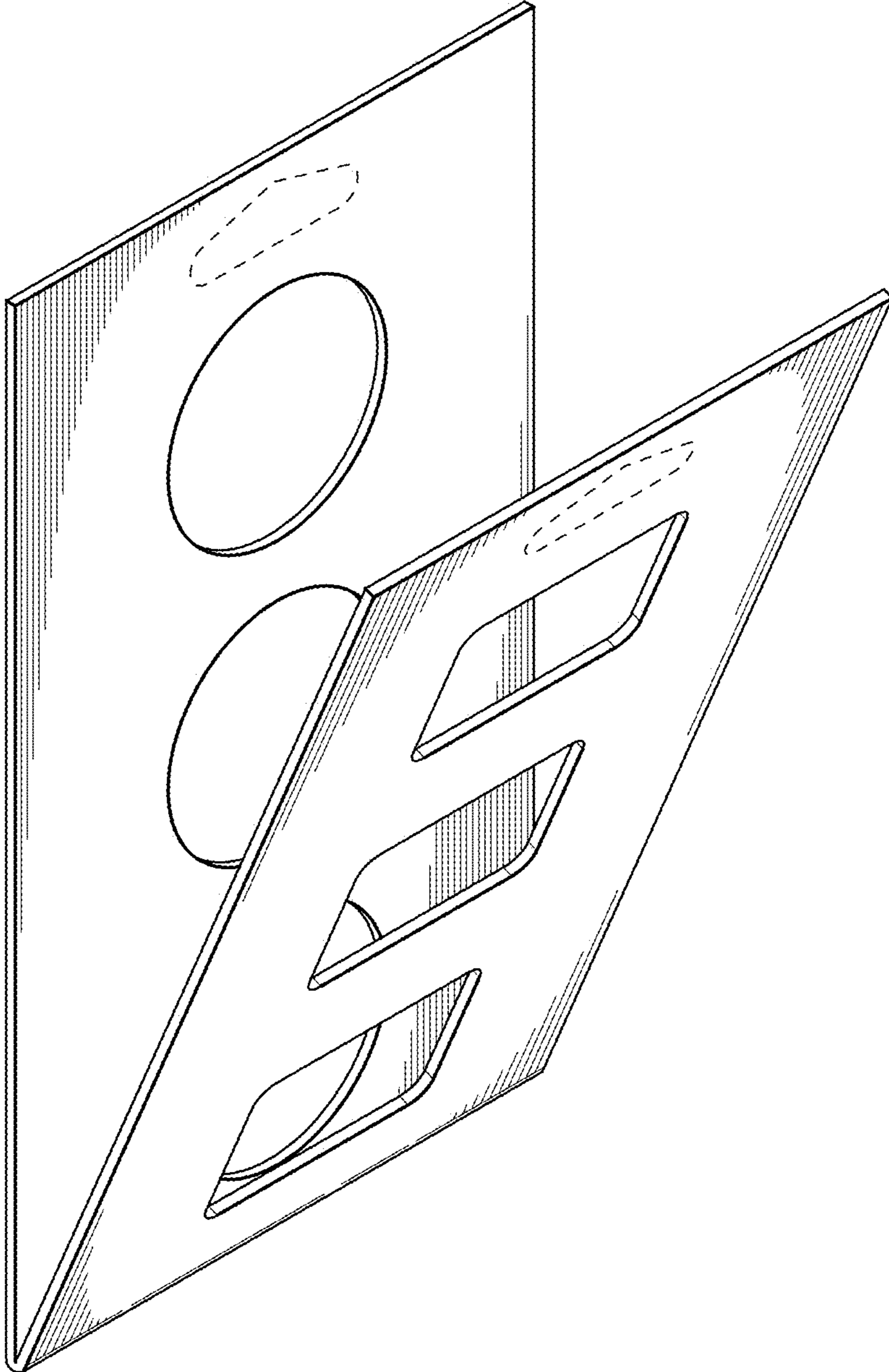

Fig. 17.

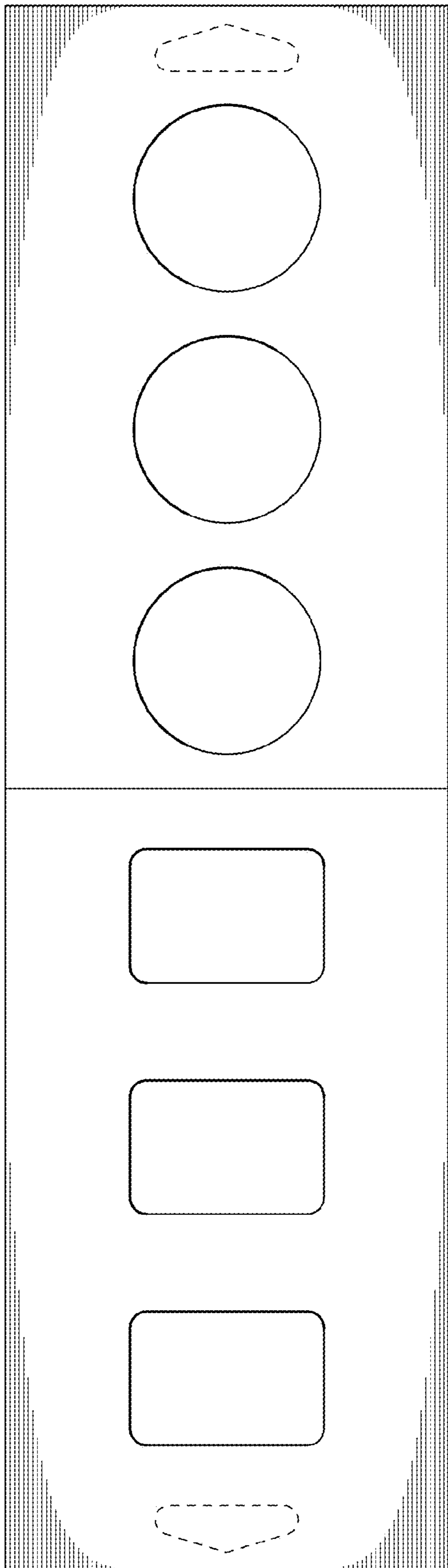

Fig. 18.

REPLACEMENT SHEET

13/36

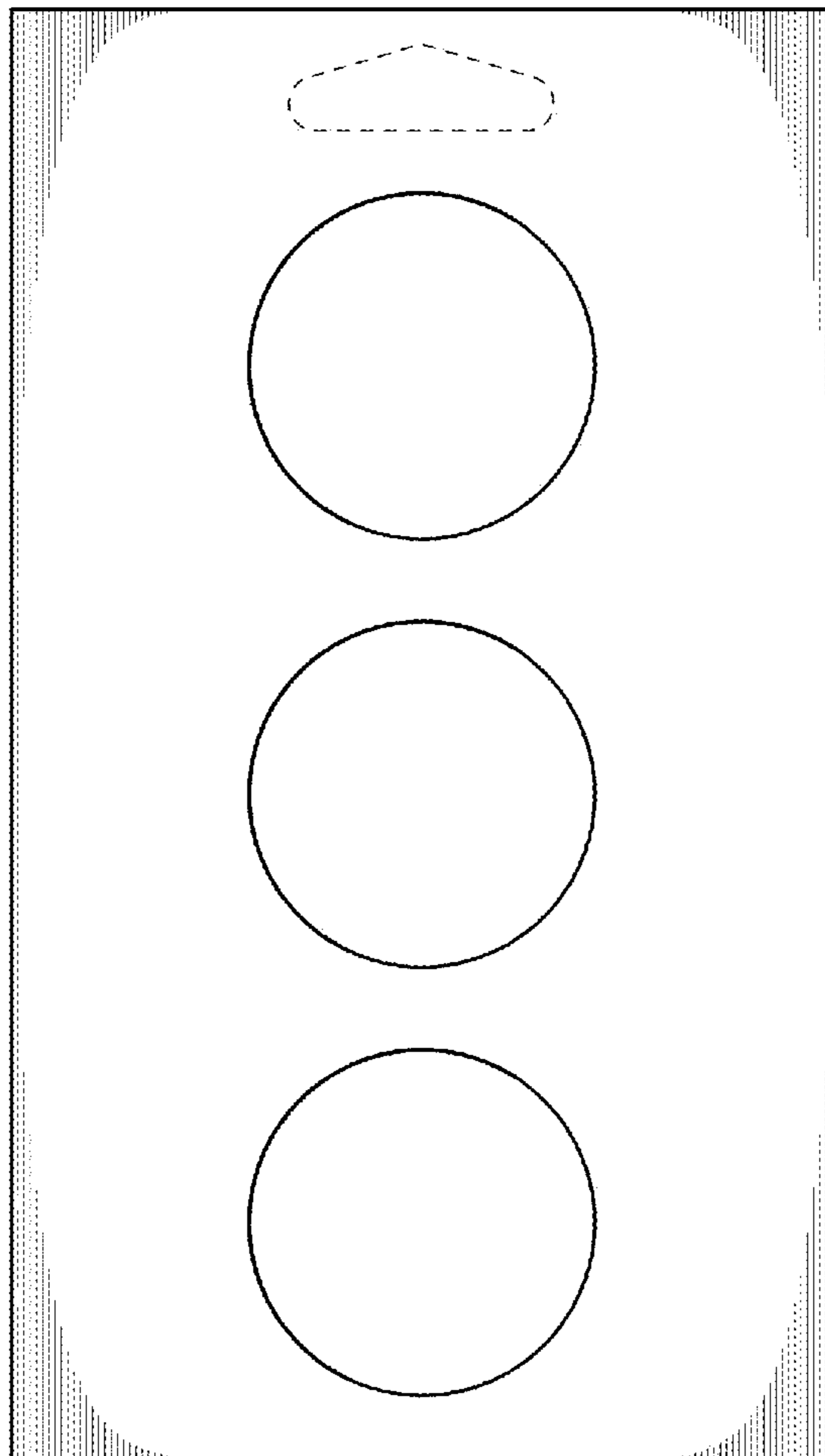

Fig. 19.

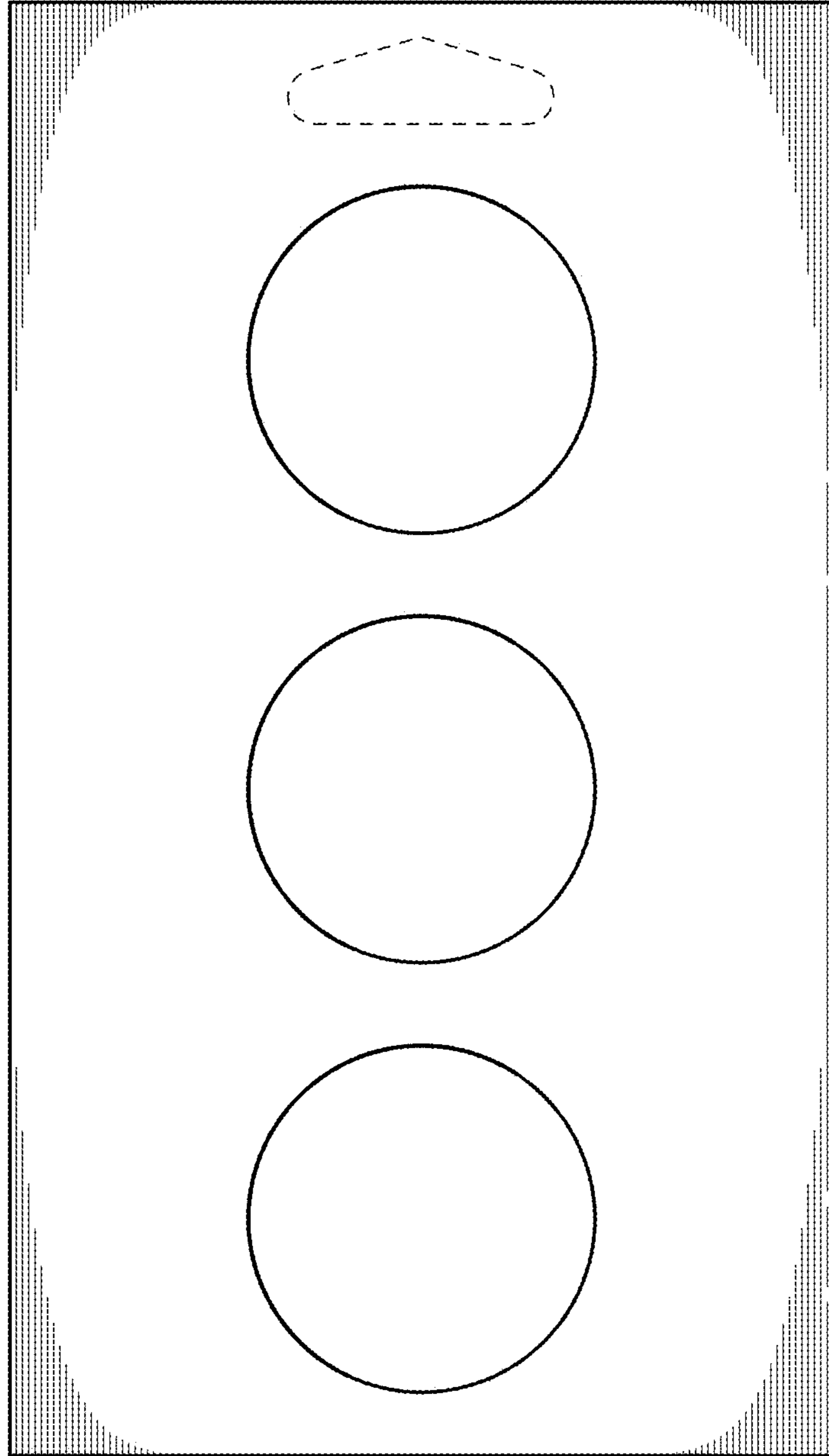

Fig. 20.



Fig. 21.

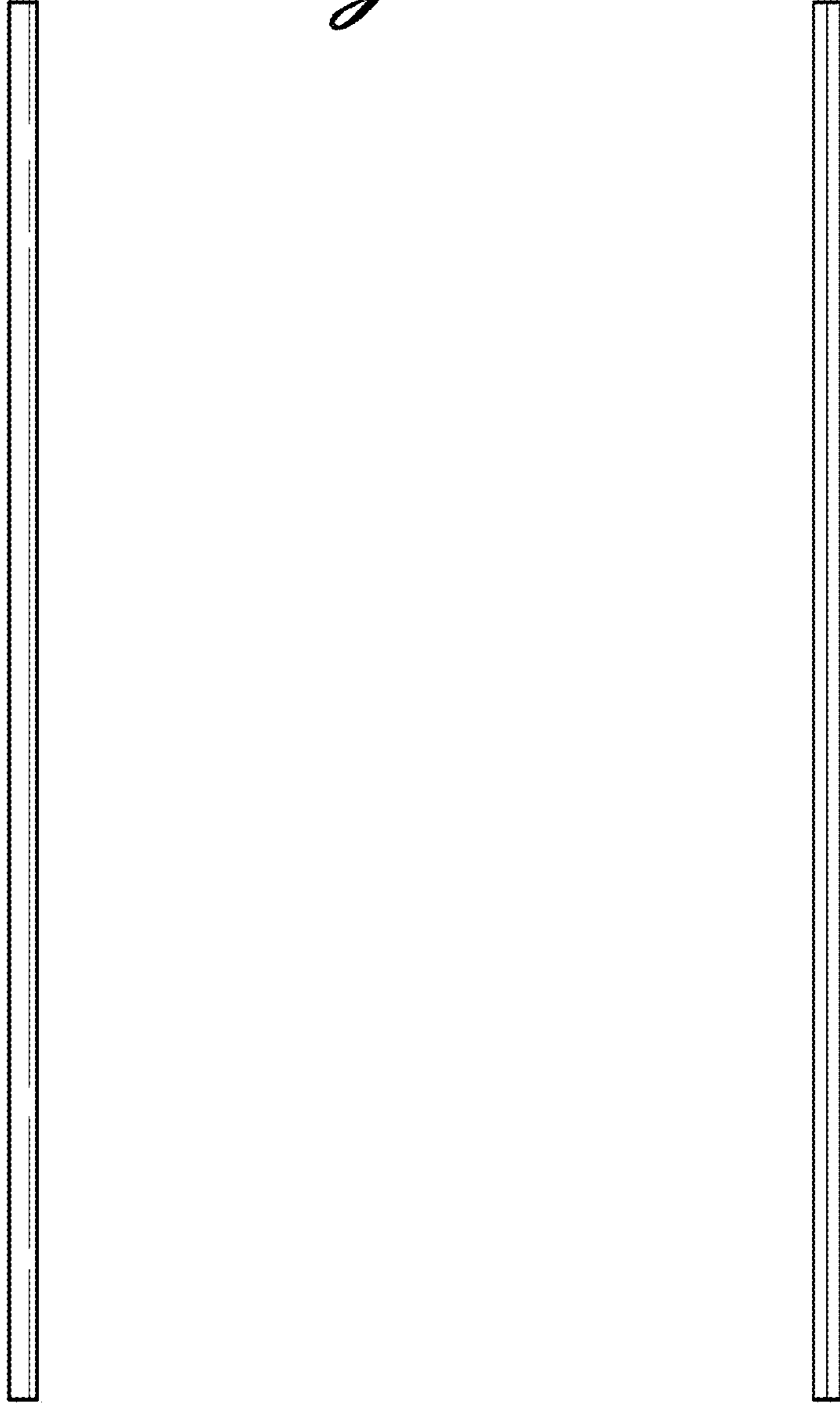

Fig. 23.

Fig. 24.

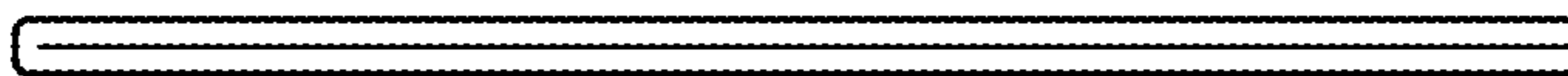

Fig. 22.

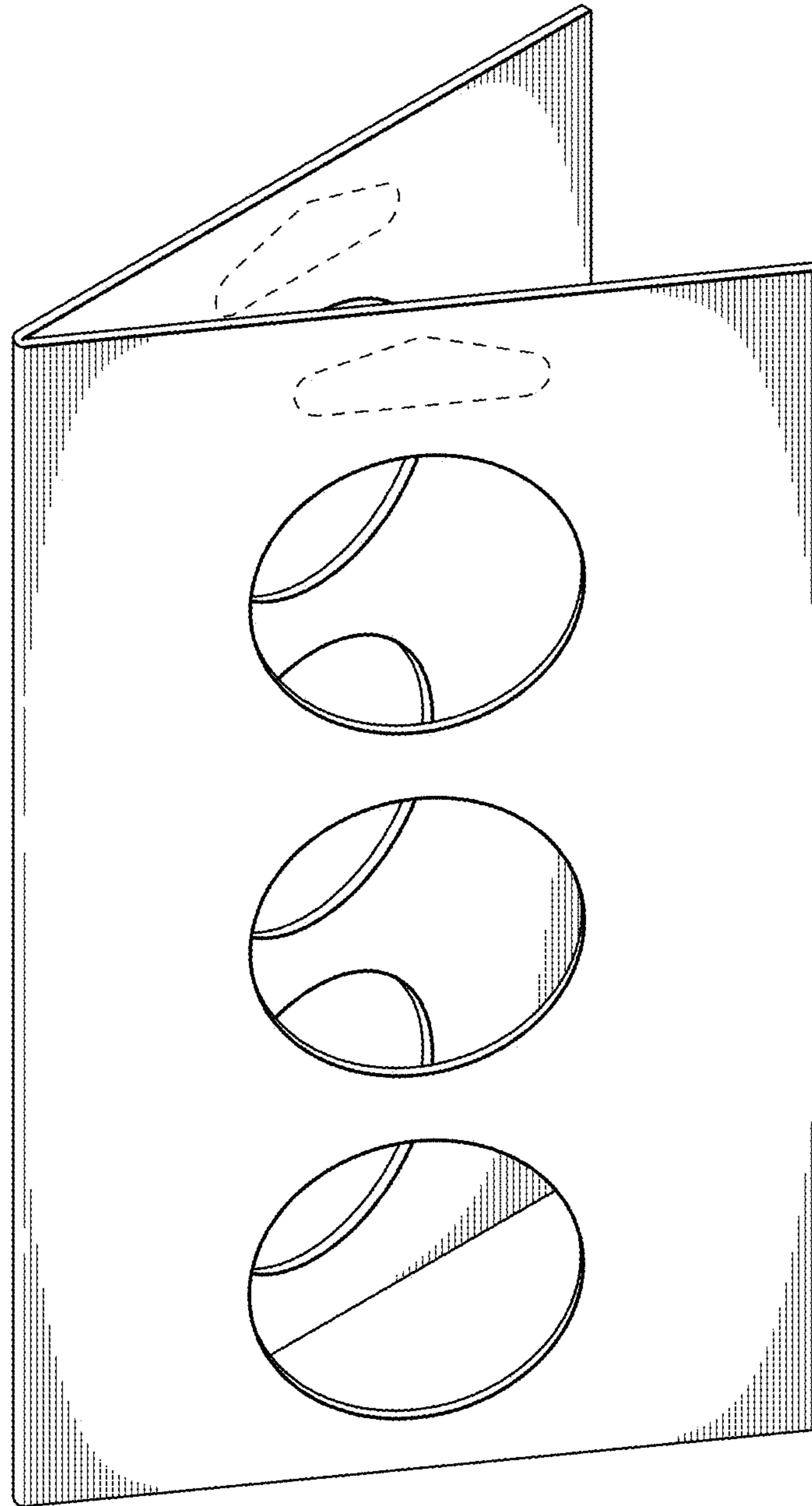

Fig. 25.

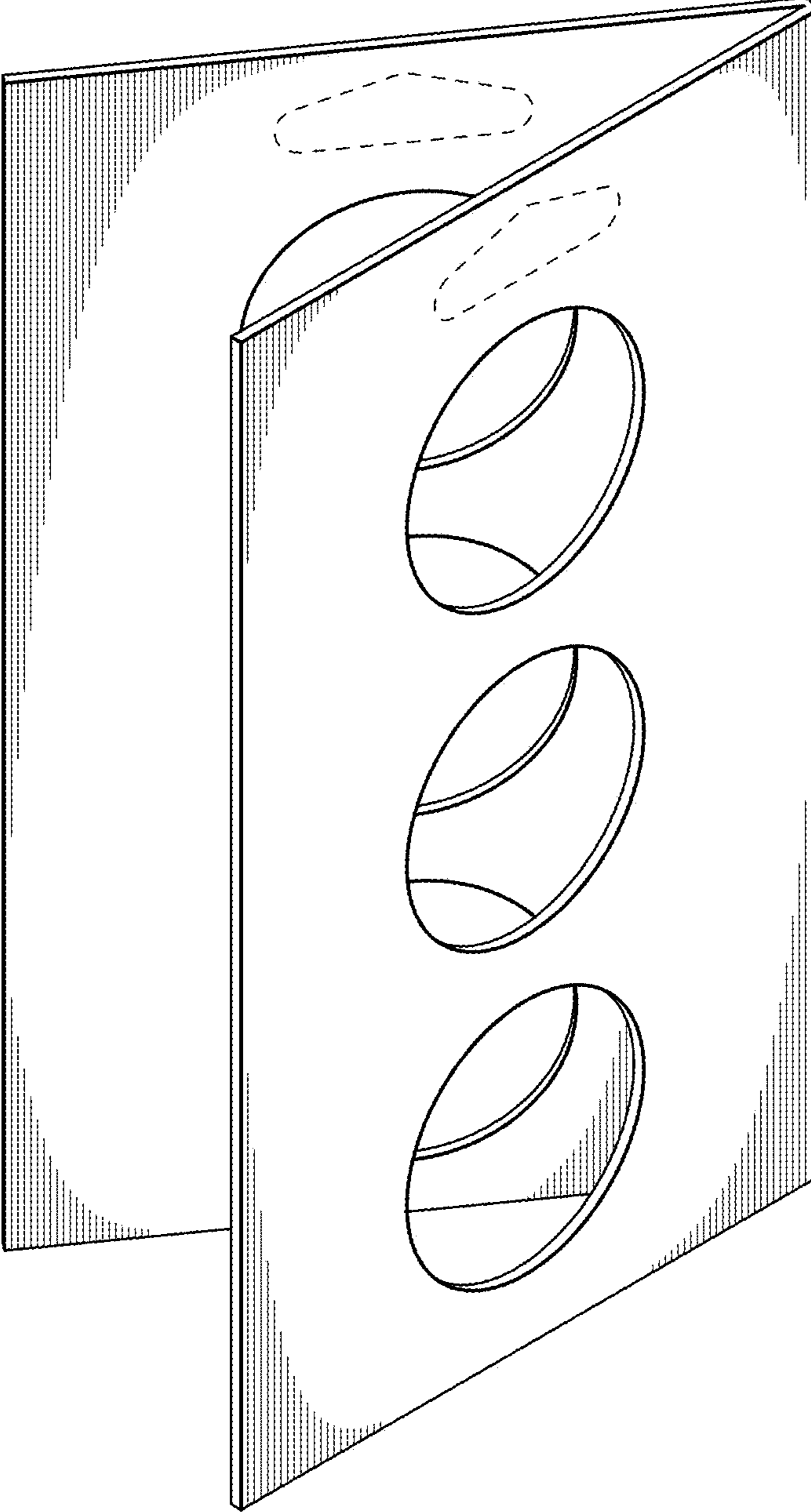
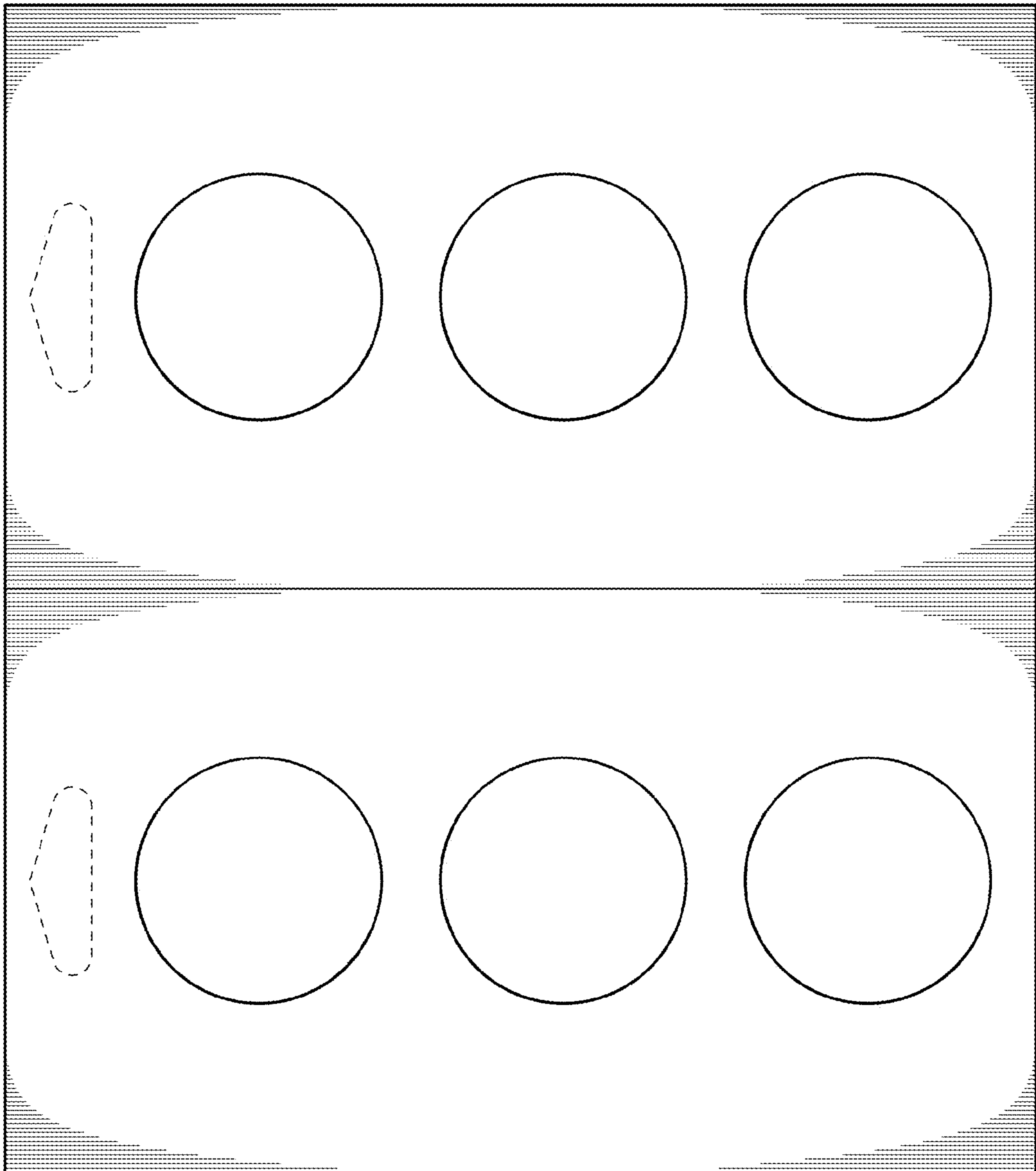

Fig. 26.

Fig. 27.



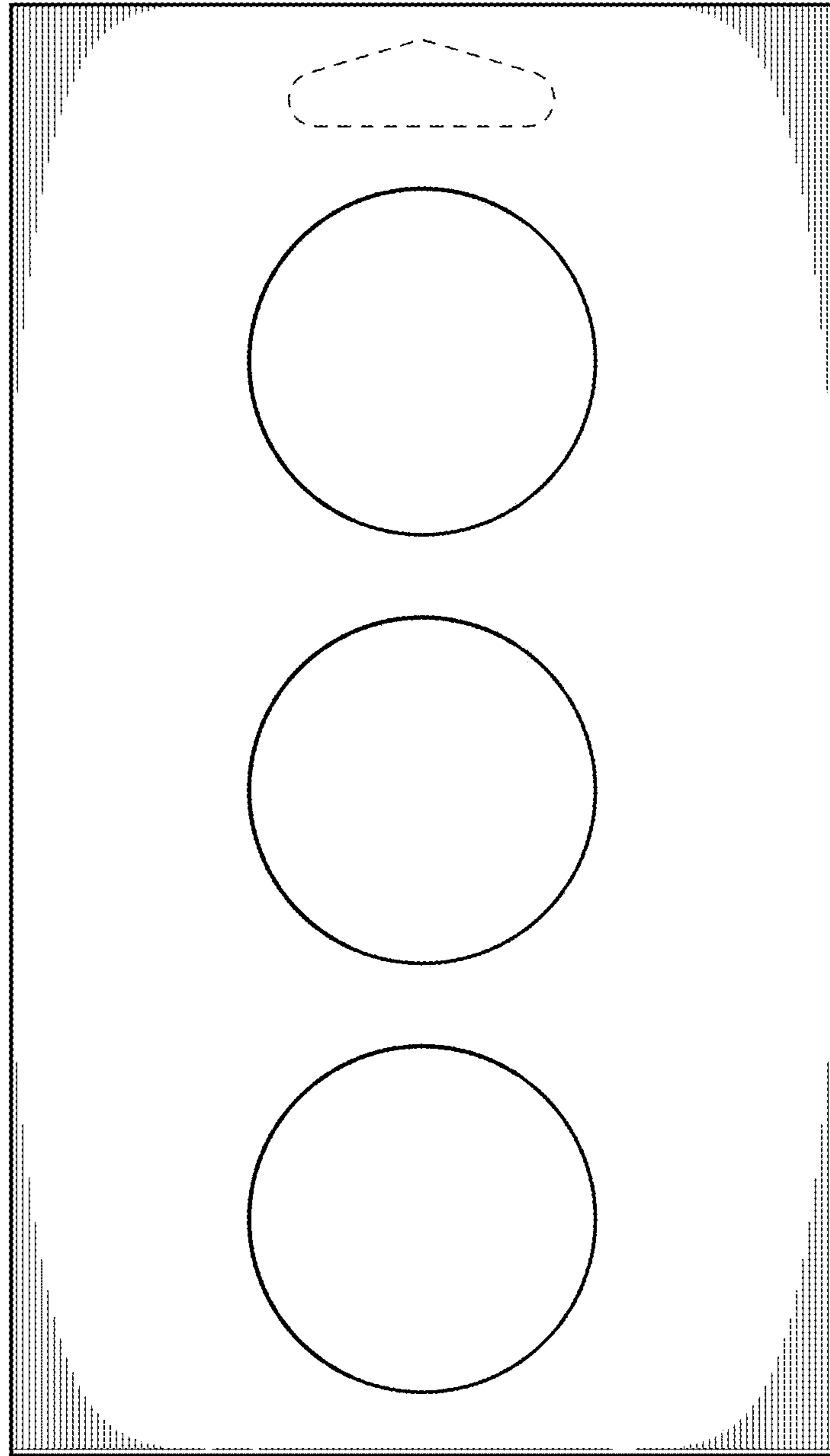

Fig. 28.

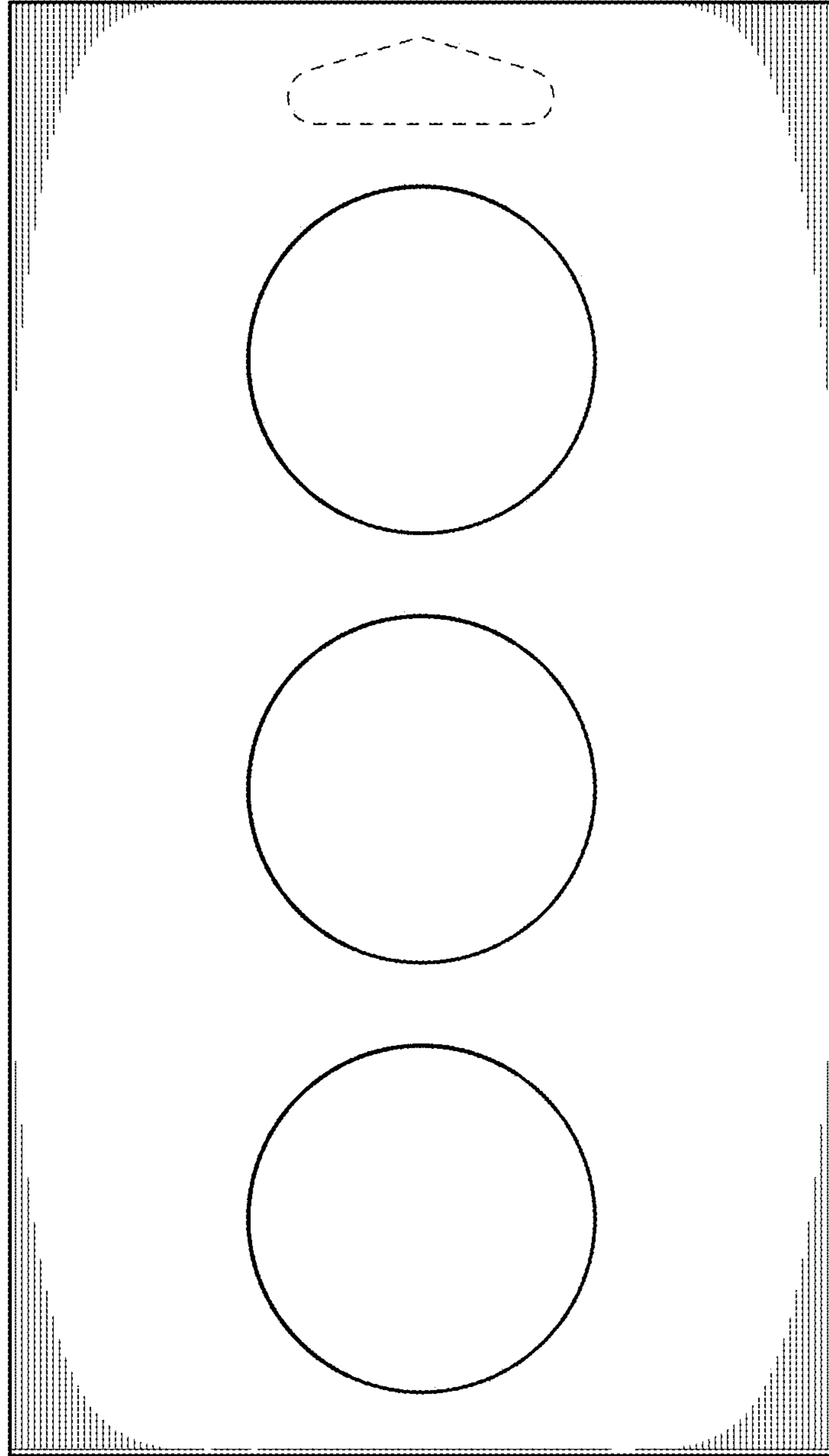

Fig. 29.

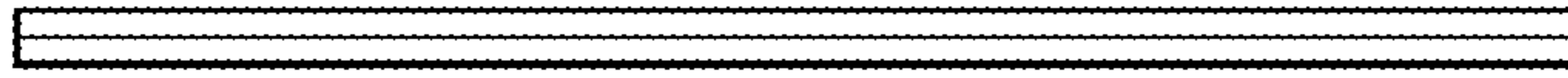

Fig.30.

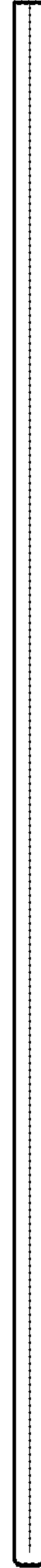

Fig.32.

Fig.33.

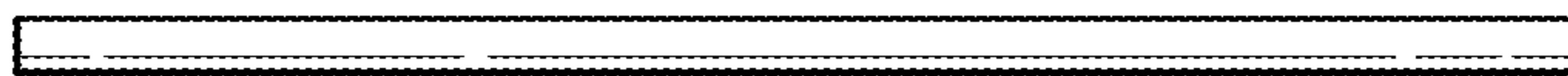

Fig.34.

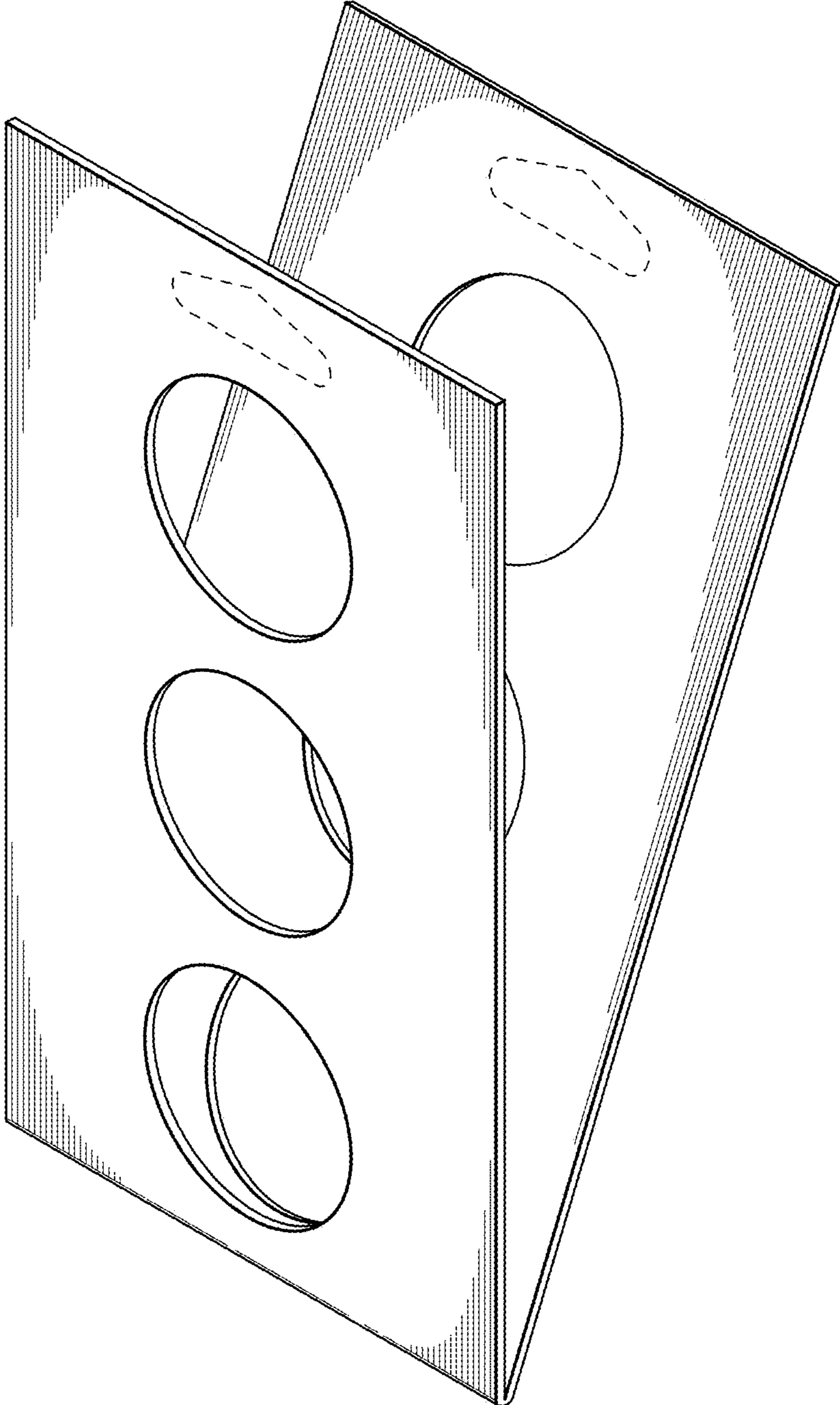

Fig. 34.

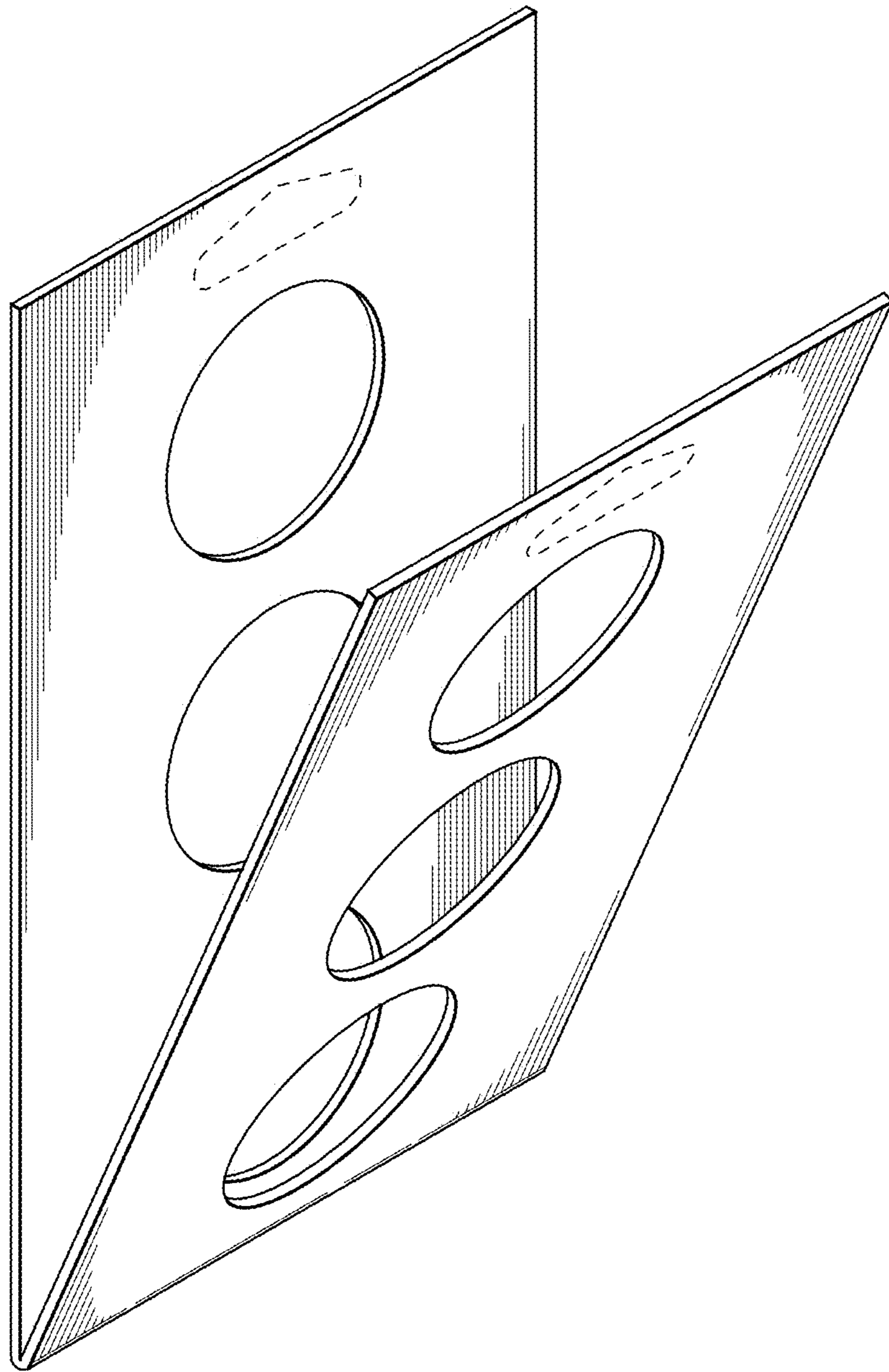

Fig. 35.

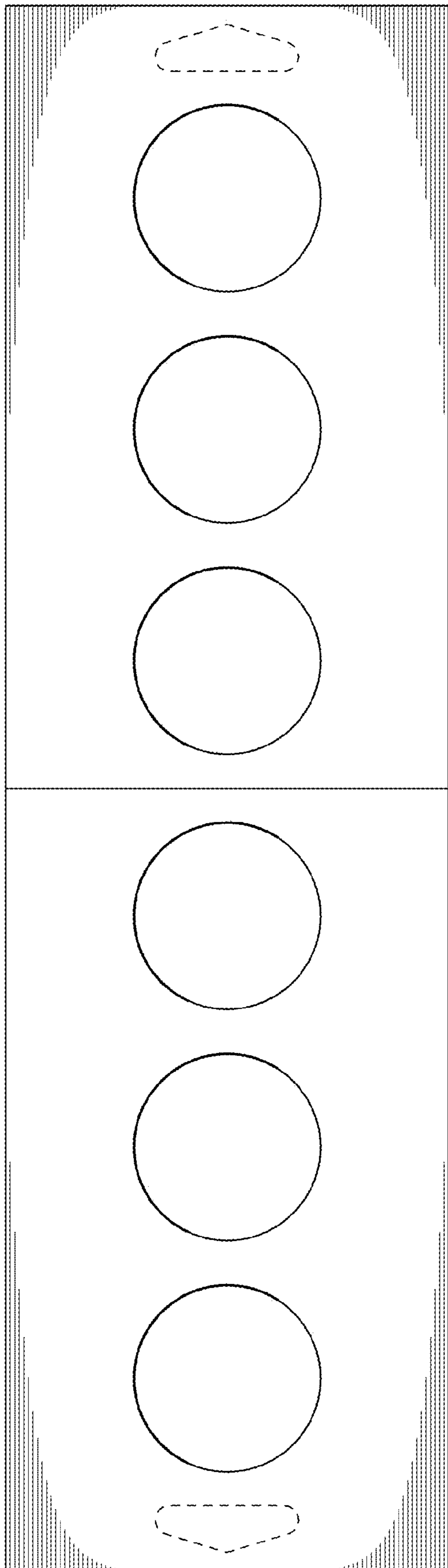

Fig. 36.

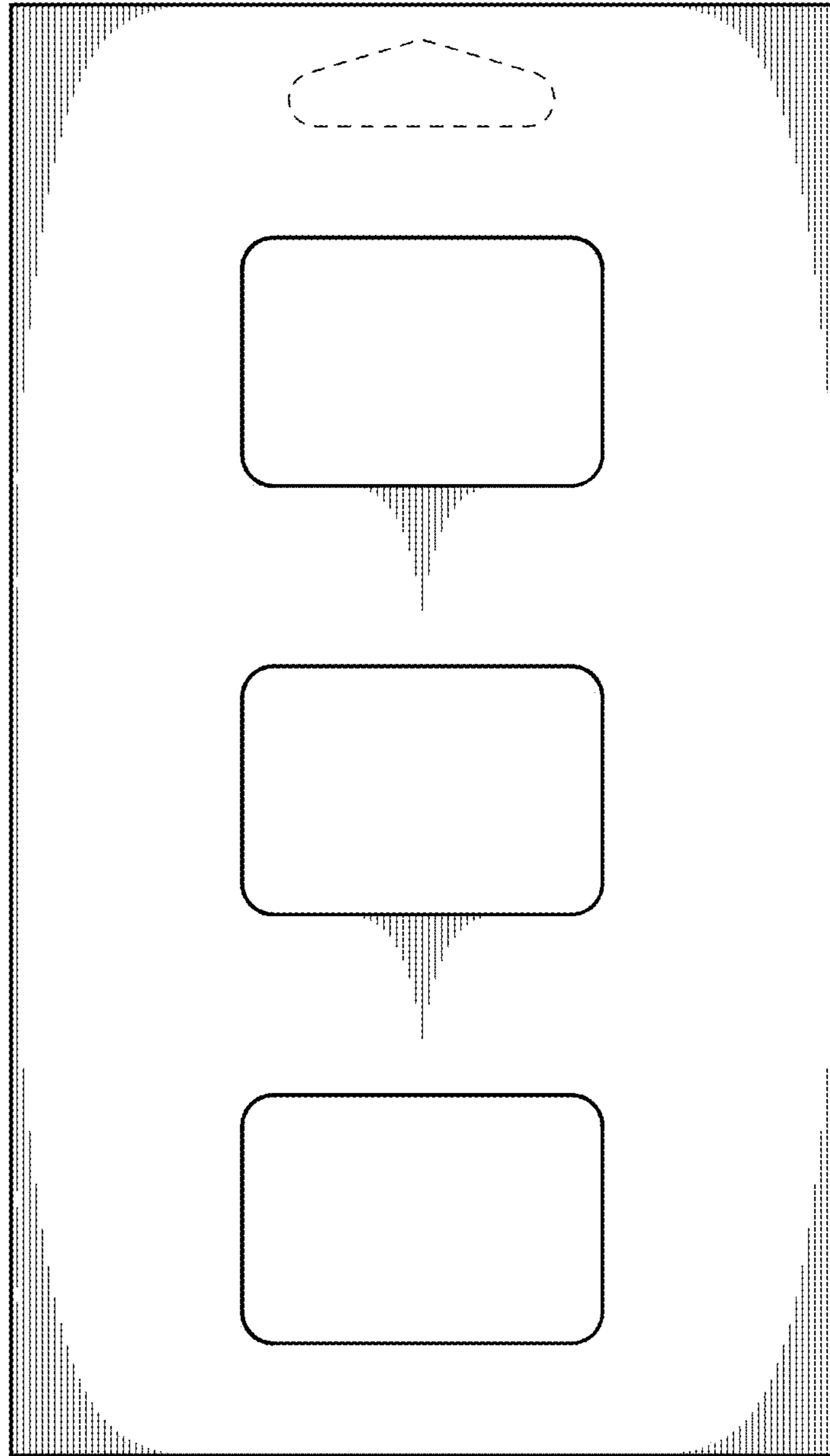

Fig. 37.

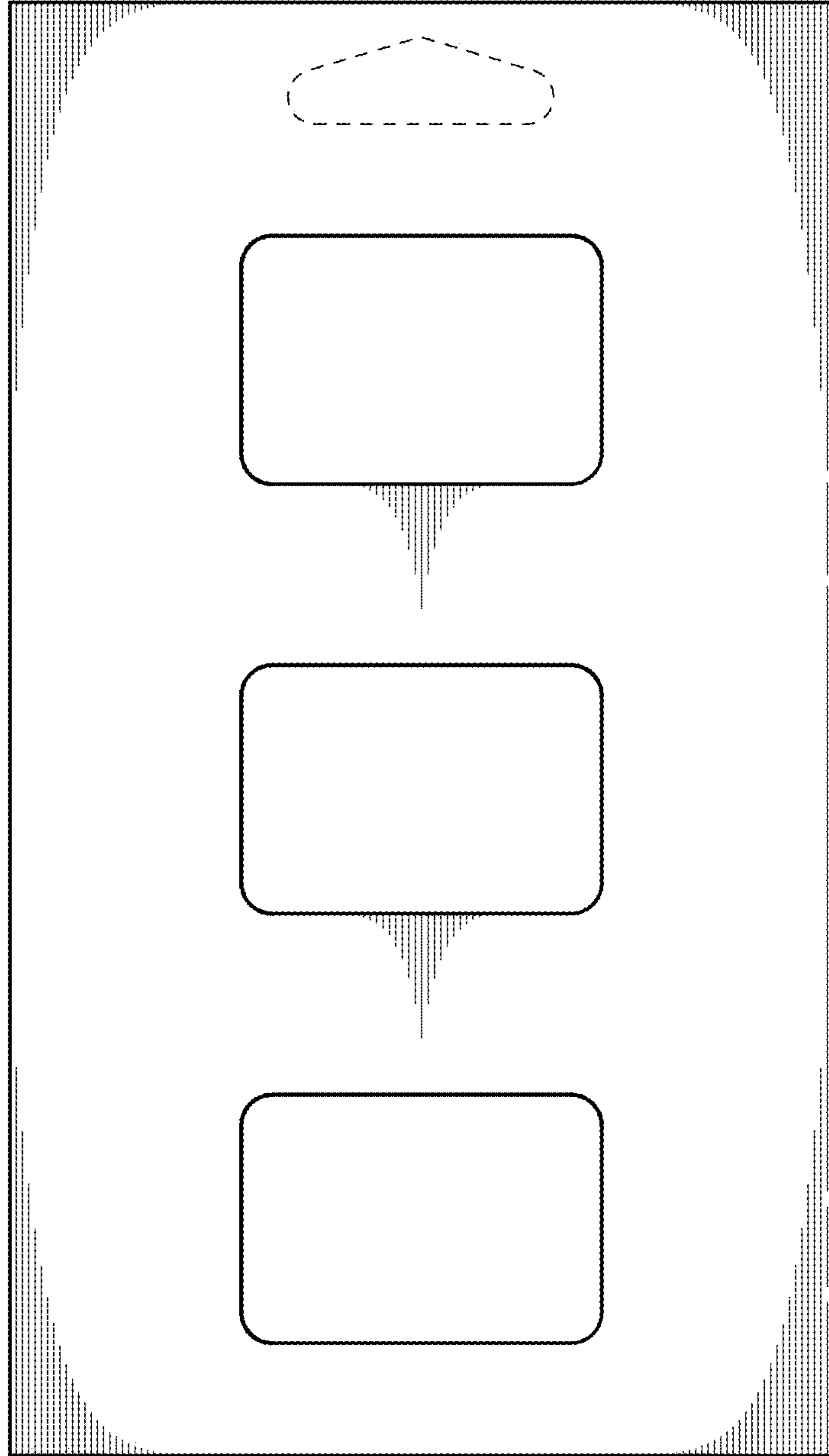

Fig. 38.



Fig.39.

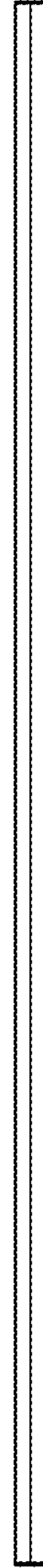

Fig.41.

Fig.42.

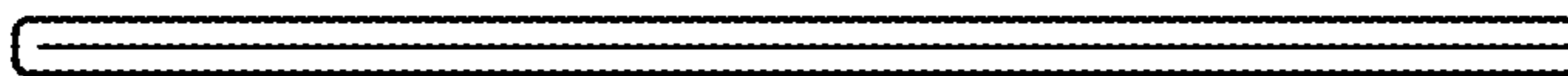

Fig.40.

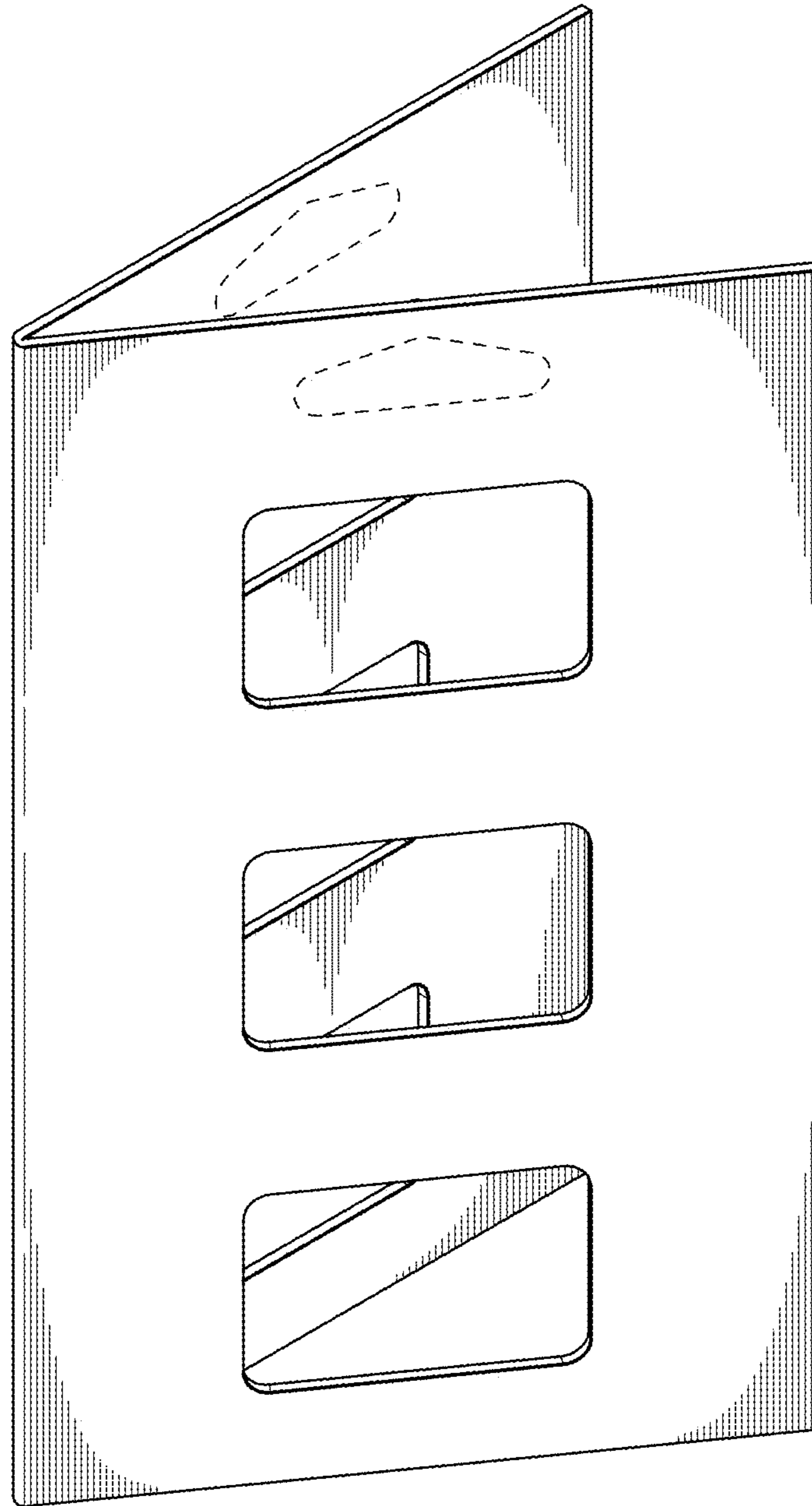

Fig. 43.

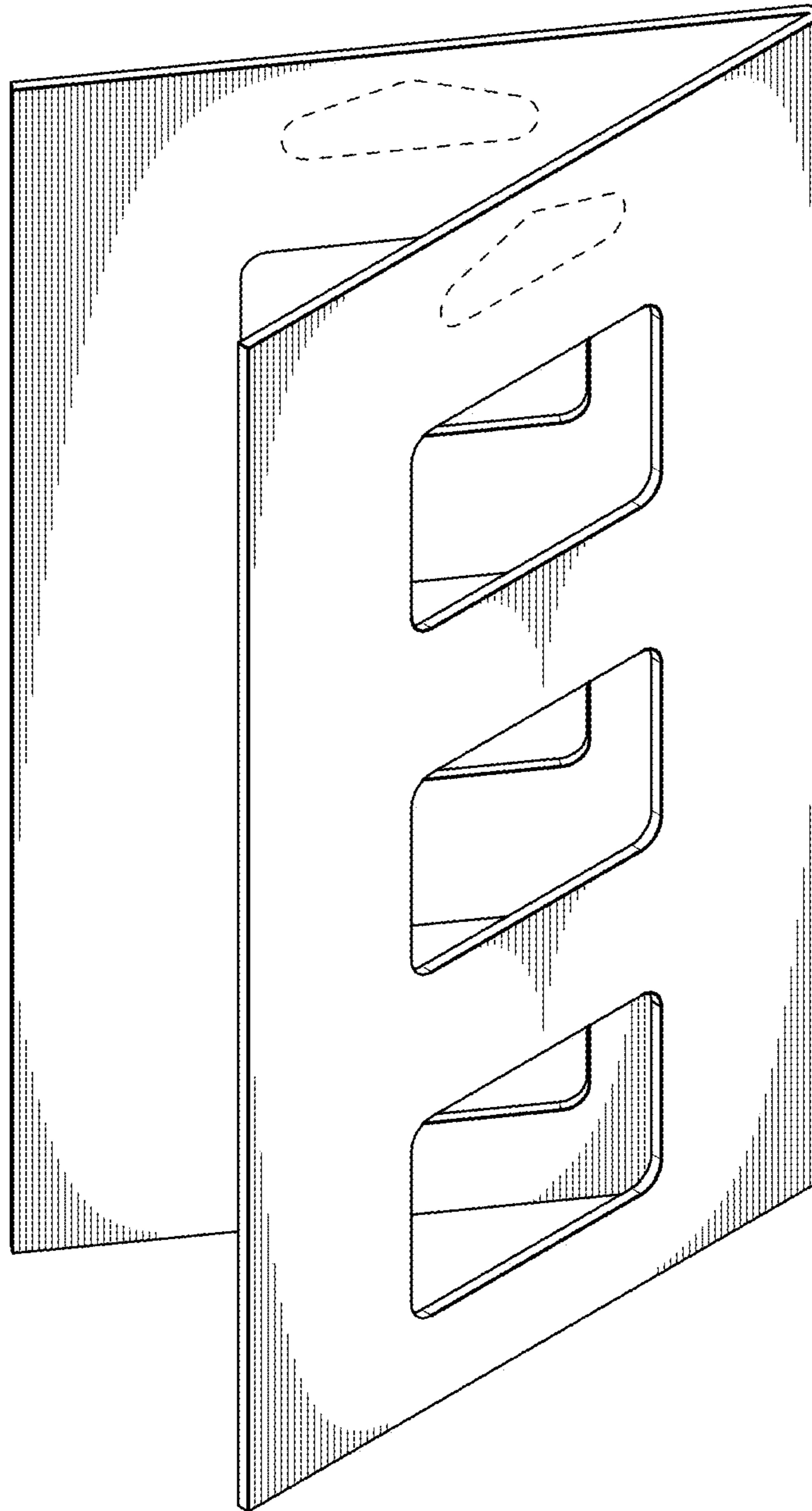
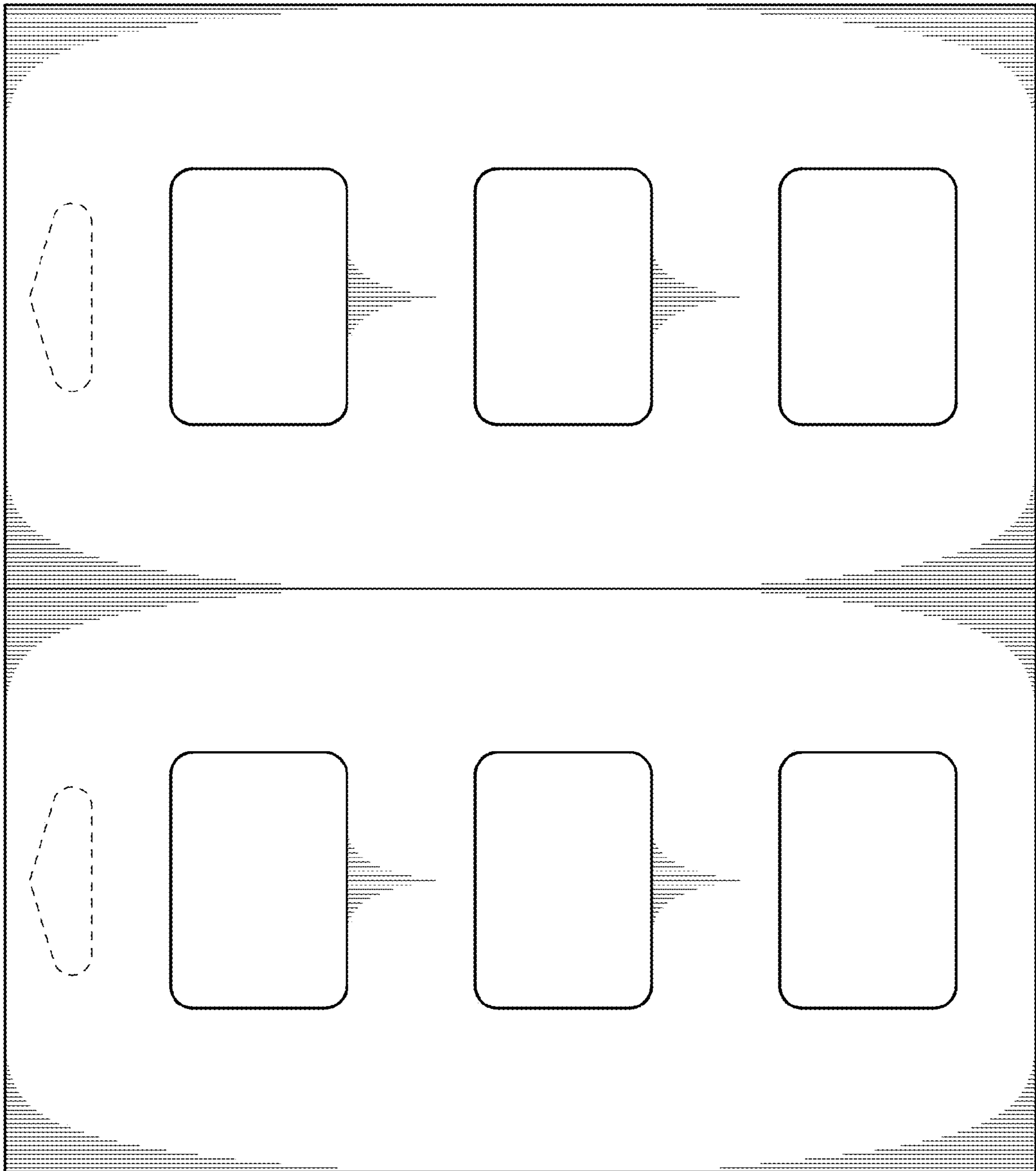

Fig. 44.

Fig. 45.



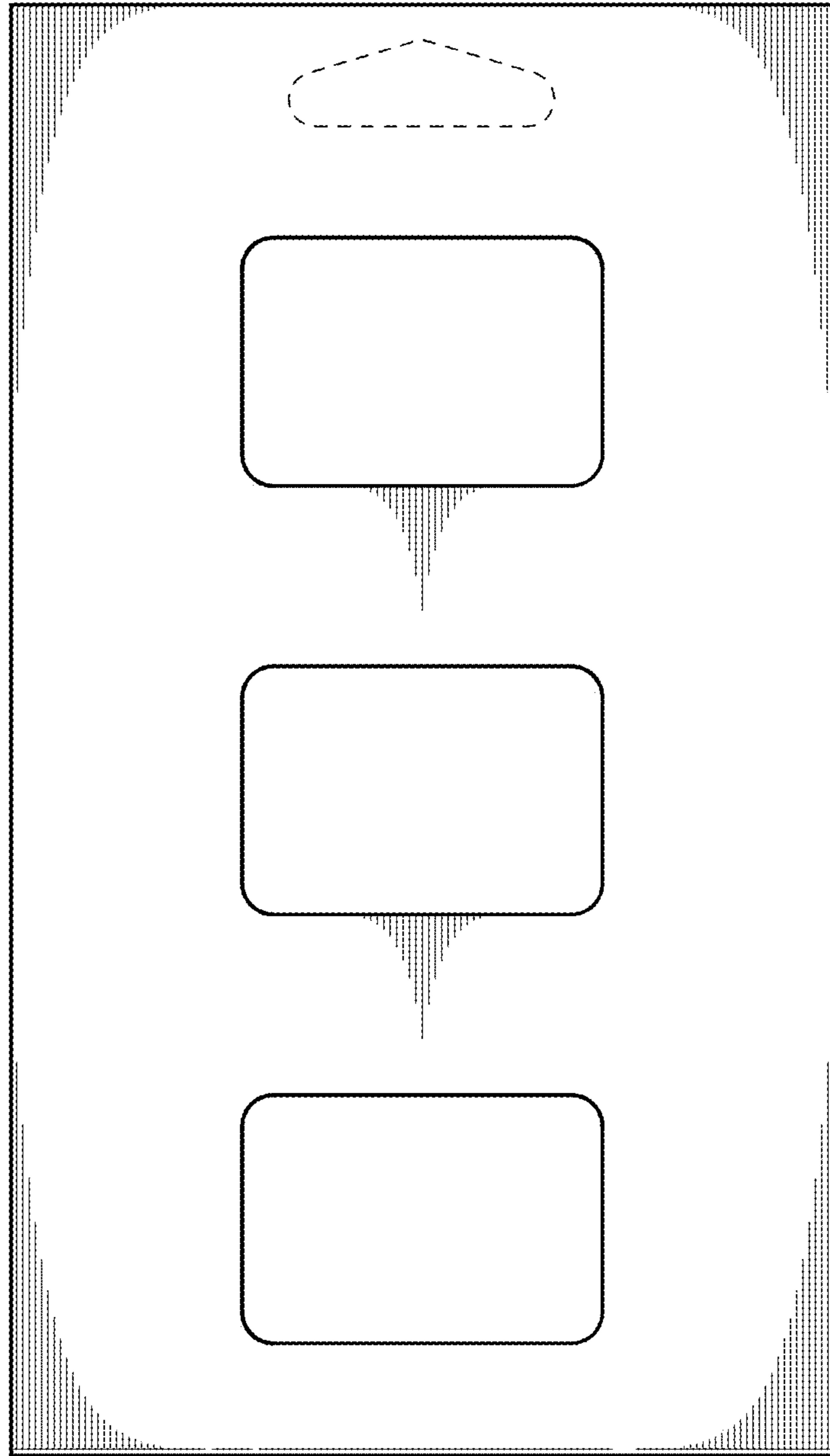

Fig. 46.

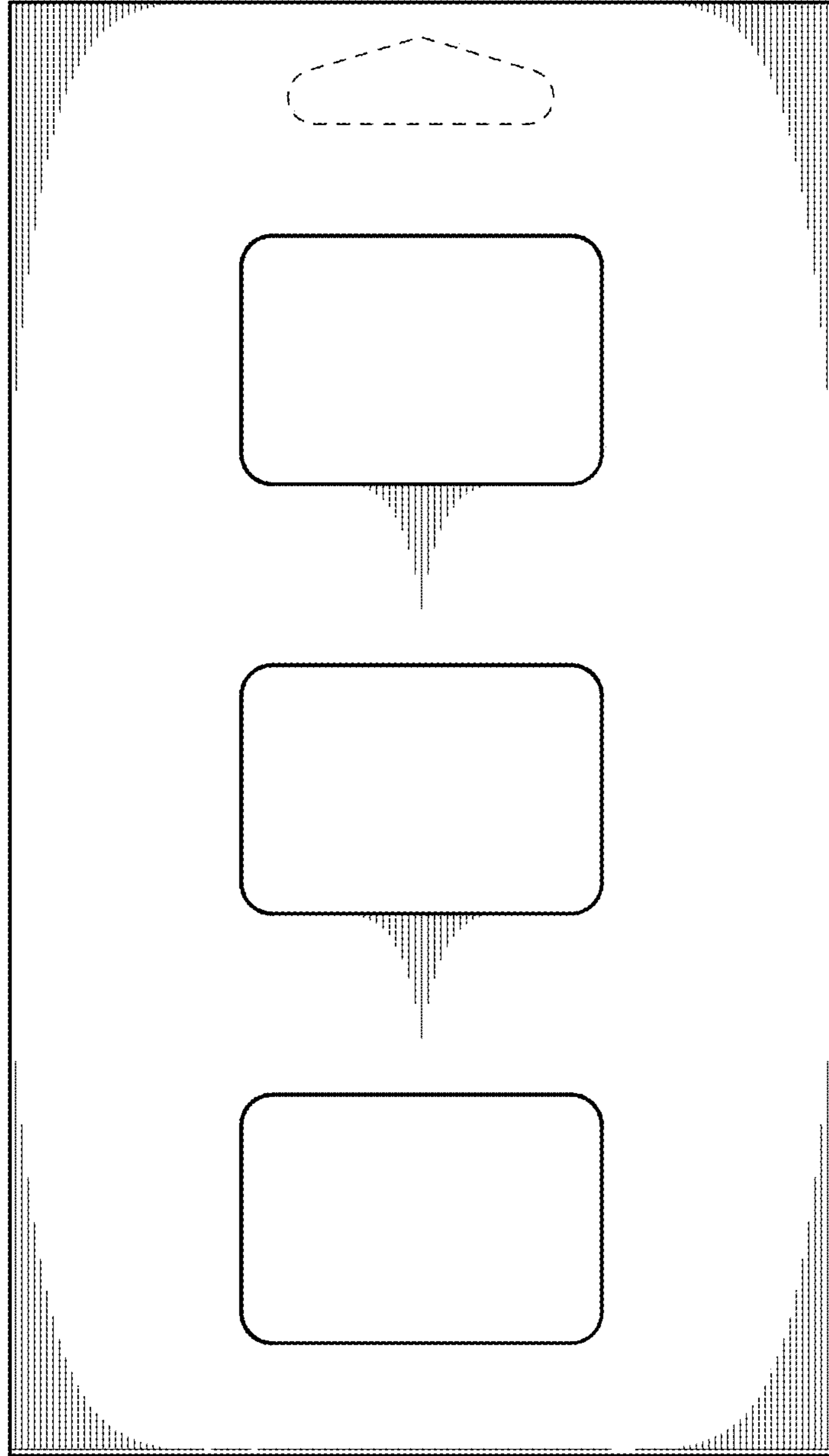

Fig. 47.



Fig. 48.

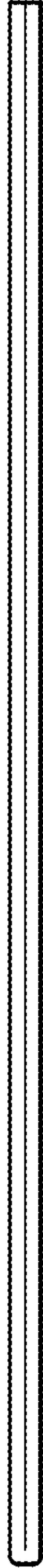

Fig. 50.

Fig. 51.

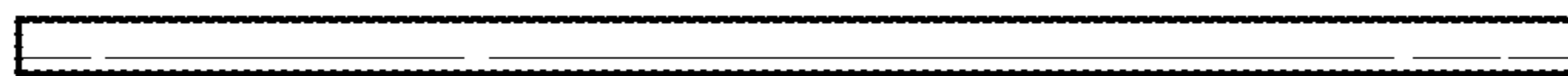

Fig. 49.

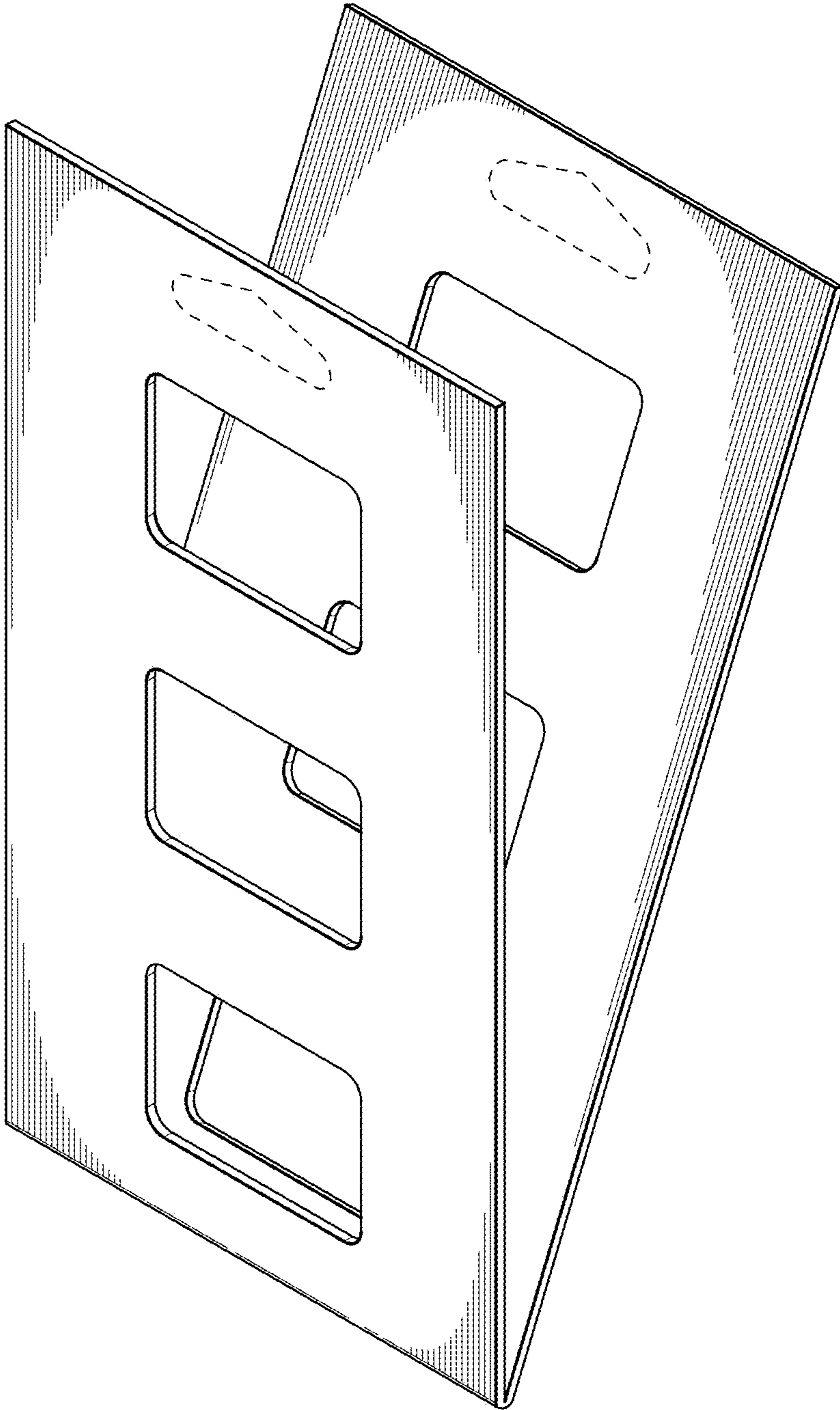

Fig. 52.

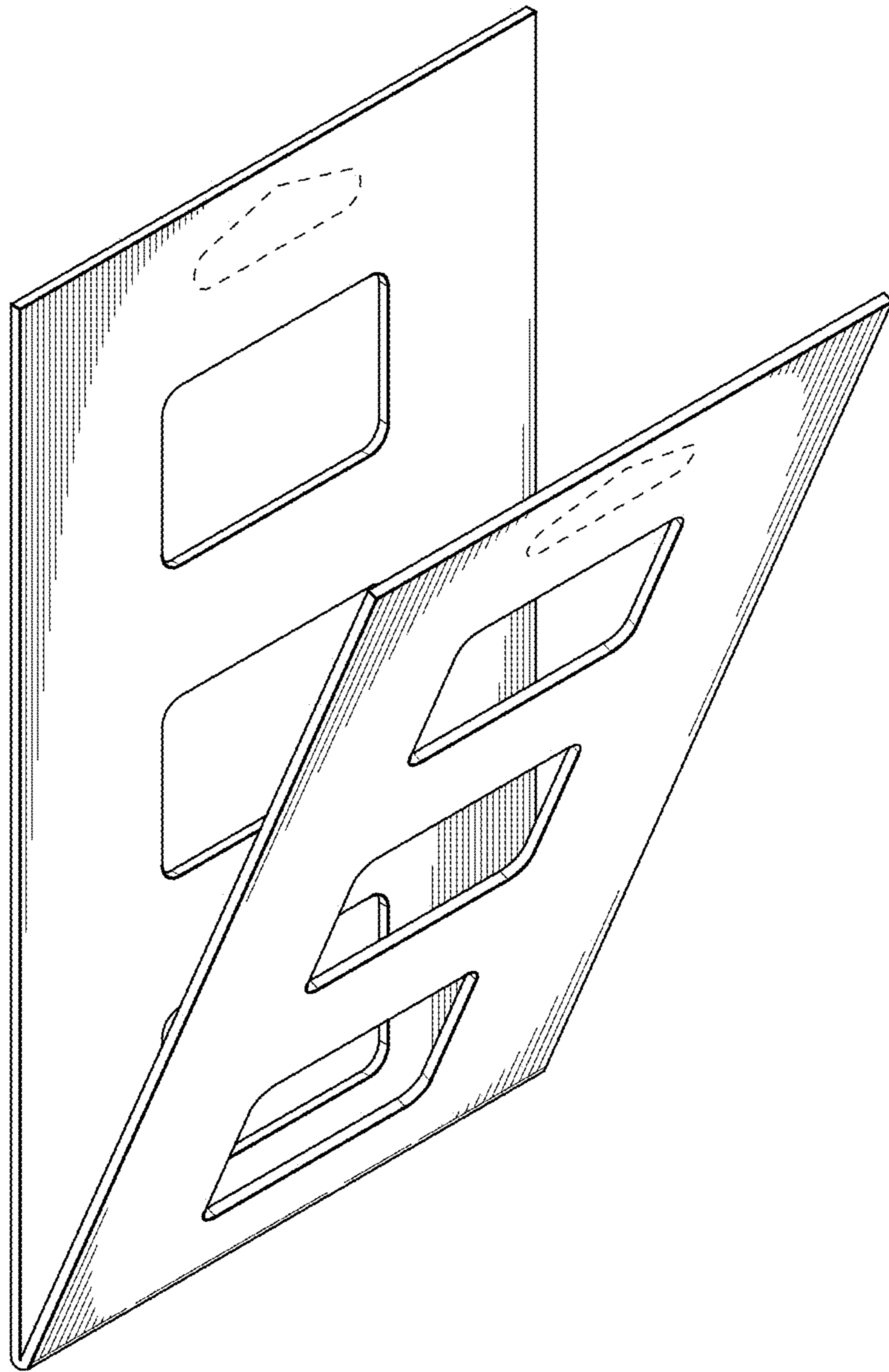

Fig. 53.

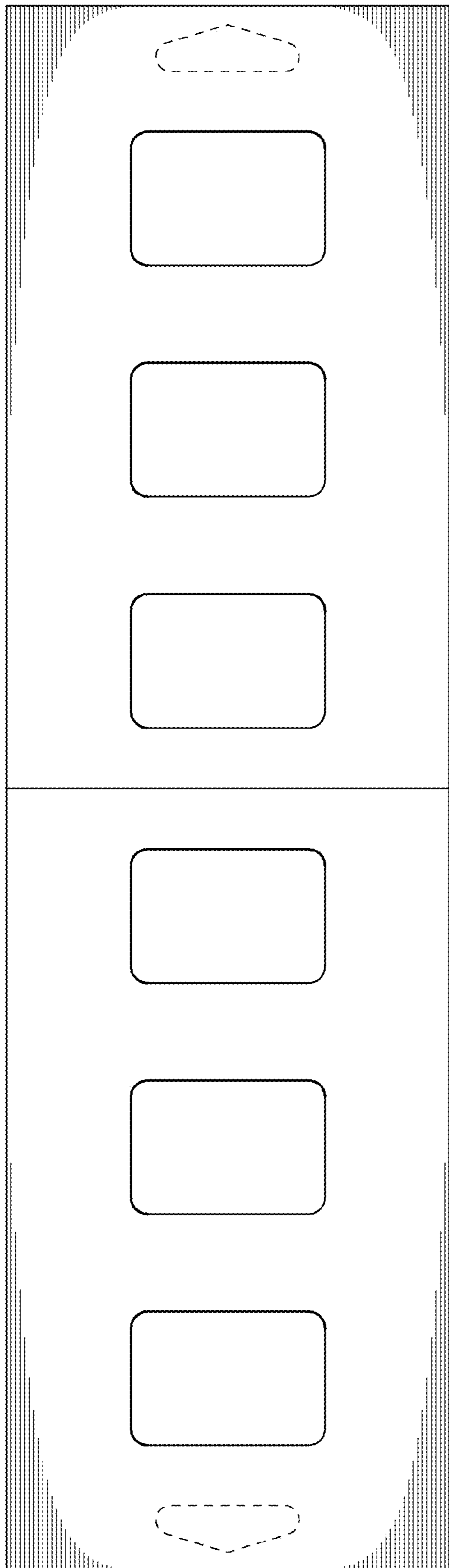

Fig. 54.