



US00D964155S

(12) **United States Design Patent** (10) **Patent No.:** **US D964,155 S**  
**Bodurov et al.** (45) **Date of Patent:** **\*\* Sep. 20, 2022**

(54) **NAIL**  
(71) Applicant: **Relo-Nail Ltd.**, Sofia (BG)  
(72) Inventors: **Petar Bodurov**, Sofia (BG); **Pencho Sirakov**, Sofia (BG); **Todor Penchev**, Sofia (BG); **Dimitar Mihaylov**, Sofia (BG)

4,979,859 A \* 12/1990 Castleberry ..... F16B 15/00  
411/452  
D624,810 S \* 10/2010 Vosbikian ..... D8/391  
D644,093 S \* 8/2011 Togami ..... D8/391  
D683,208 S \* 5/2013 Nocelo Stelin ..... D8/391  
D880,998 S \* 4/2020 Kilgore ..... D8/391

(\*\*) Term: **15 Years**

FOREIGN PATENT DOCUMENTS

CN 305406568 \* 10/2019

(21) Appl. No.: **35/511,747**

OTHER PUBLICATIONS

(22) Filed: **Apr. 12, 2021**

Penchev, T., Bodurov, P., Sirakov, P., & Mihaylov, D. (2021). A New Type of Nail for Wooden Structures with Increased Resilience, 10(7), 49-54. <https://doi.org/10.9790/0847> (Year: 2021).\*

(80) **Hague Agreement Data**

Int. Filing Date: **Apr. 12, 2021**

Int. Reg. No.: **DM/213785**

Int. Reg. Date: **Apr. 12, 2021**

Int. Reg. Pub. Date: **Apr. 30, 2021**

\* cited by examiner

*Primary Examiner* — Deanna L Pratt

(51) **LOC (13) Cl.** ..... **08-08**

(57) **CLAIM**

The ornamental design for a nail, as shown and described.

(52) **U.S. Cl.**

USPC ..... **D8/391**

**DESCRIPTION**

(58) **Field of Classification Search**

USPC ..... D8/388, 391, 392, 393

CPC ..... F16B 15/00; F16B 15/02

See application file for complete search history.

- 1. Nail
- 1.1 : Front
- 1.2 : Back
- 1.3 : Top
- 1.4 : Bottom
- 1.5 : Right
- 1.6 : Left
- 1.7 : Perspective

(56) **References Cited**

U.S. PATENT DOCUMENTS

D46,669 S \* 11/1914 Gorsuch ..... D8/391  
4,973,211 A \* 11/1990 Potucek ..... F16B 15/00  
411/452

**1 Claim, 7 Drawing Sheets**

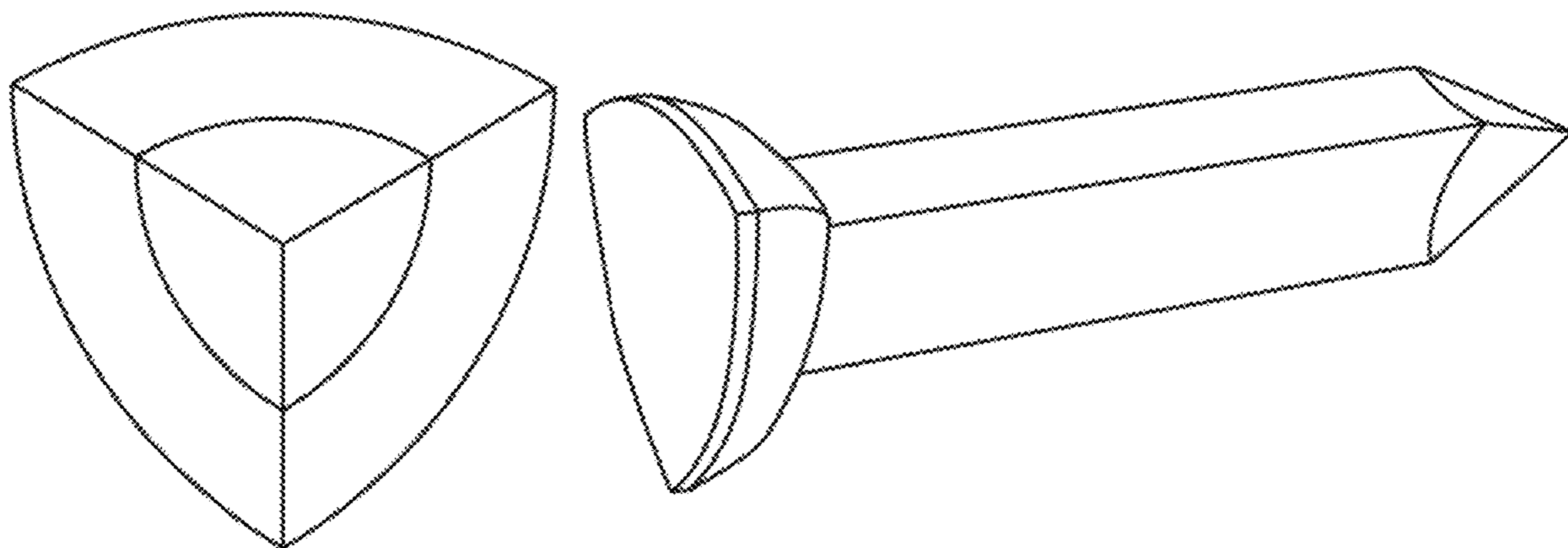

1.1

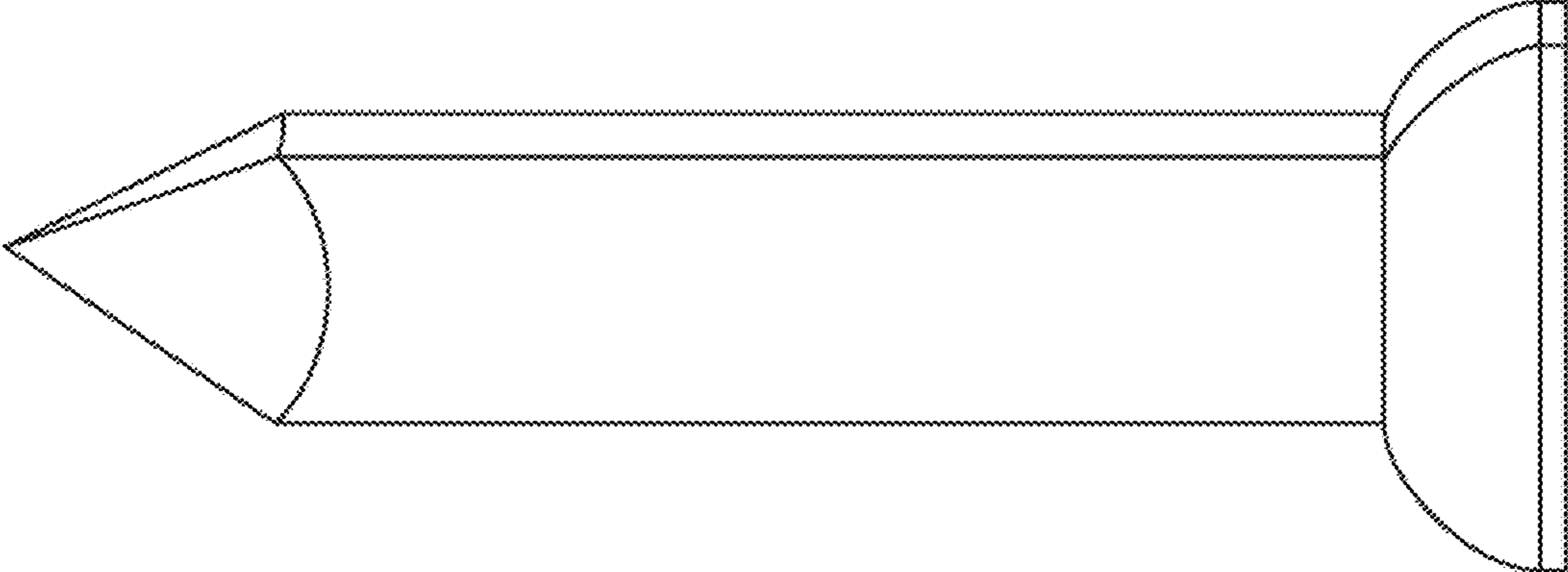

1.2

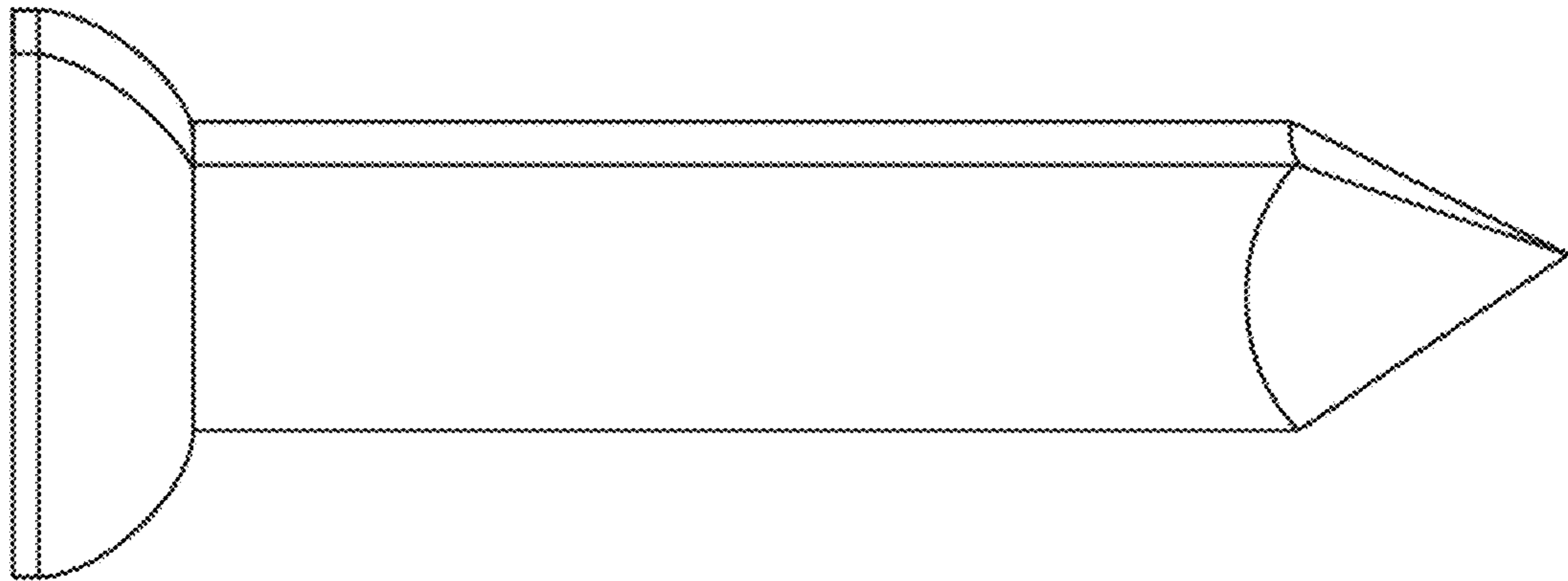

1.3

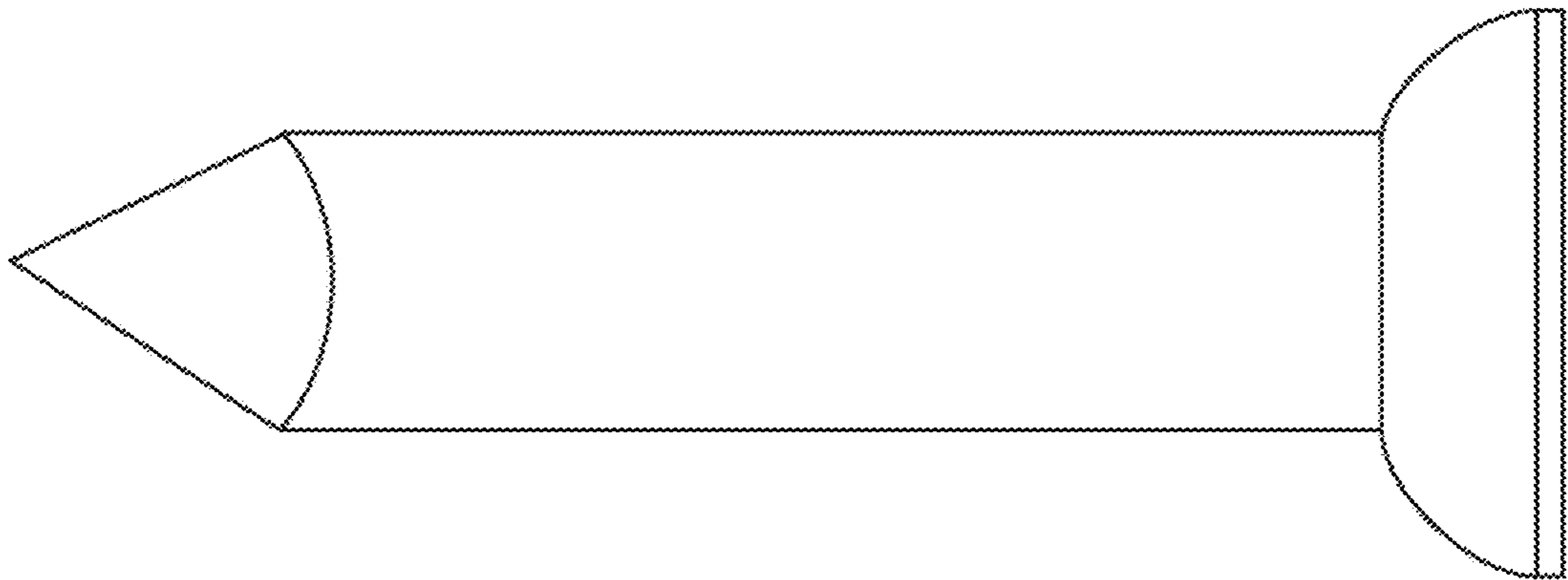

1.4

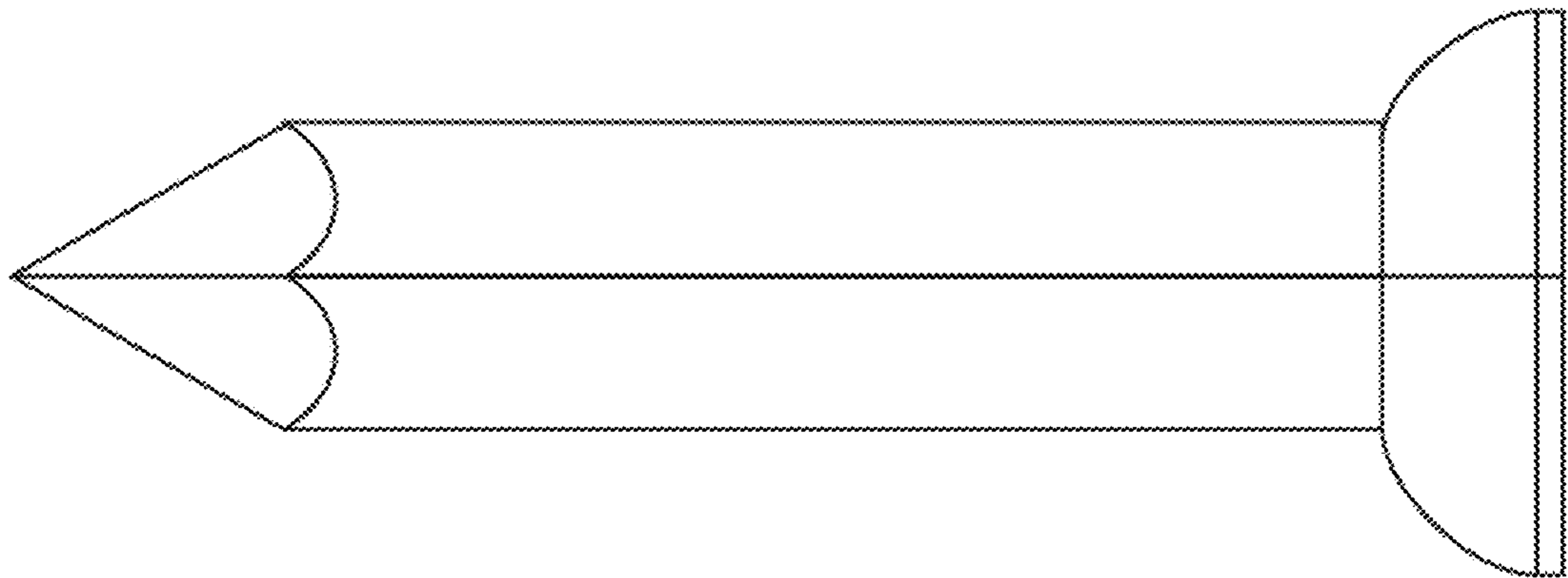

1.5

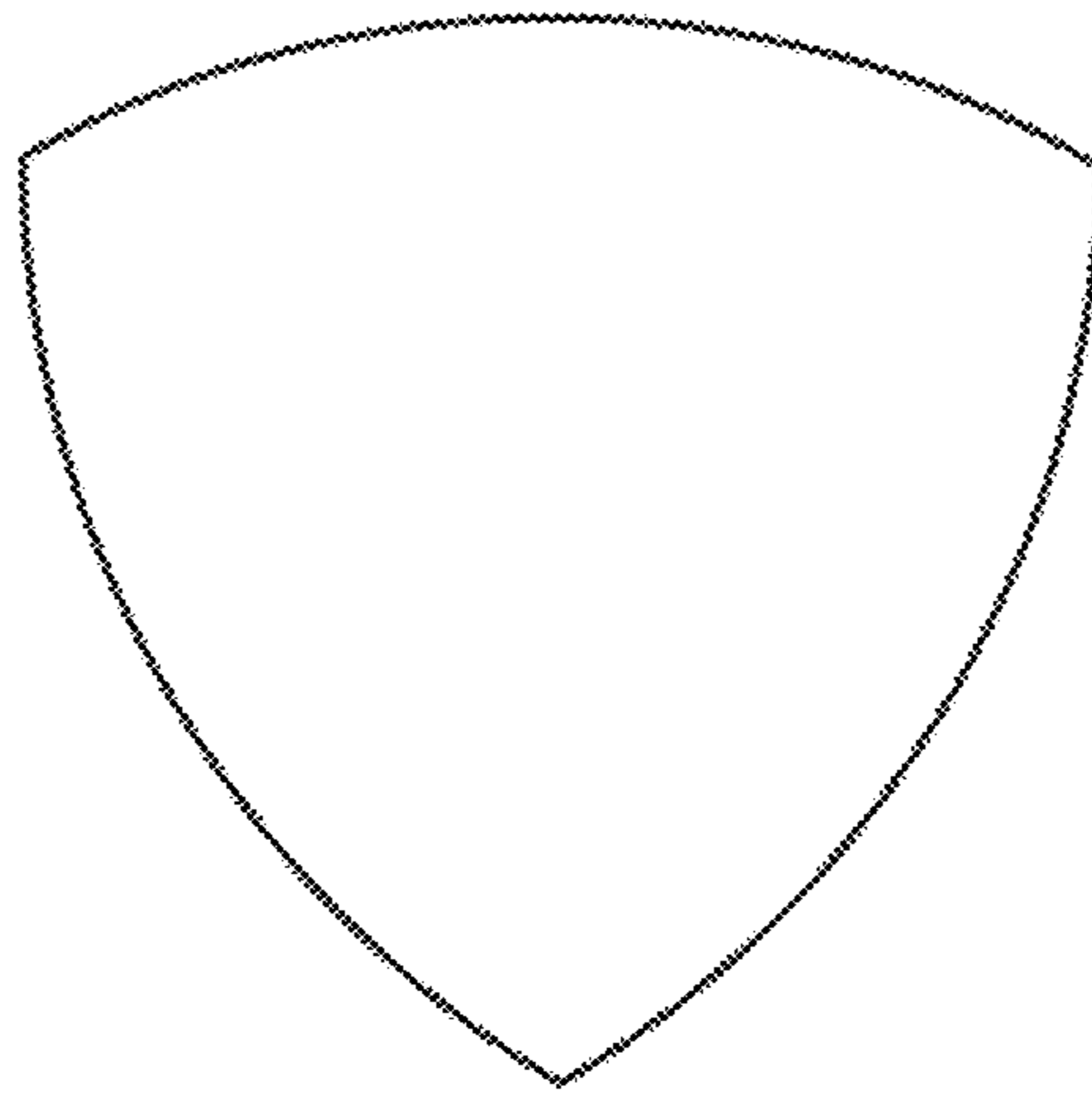

1.6

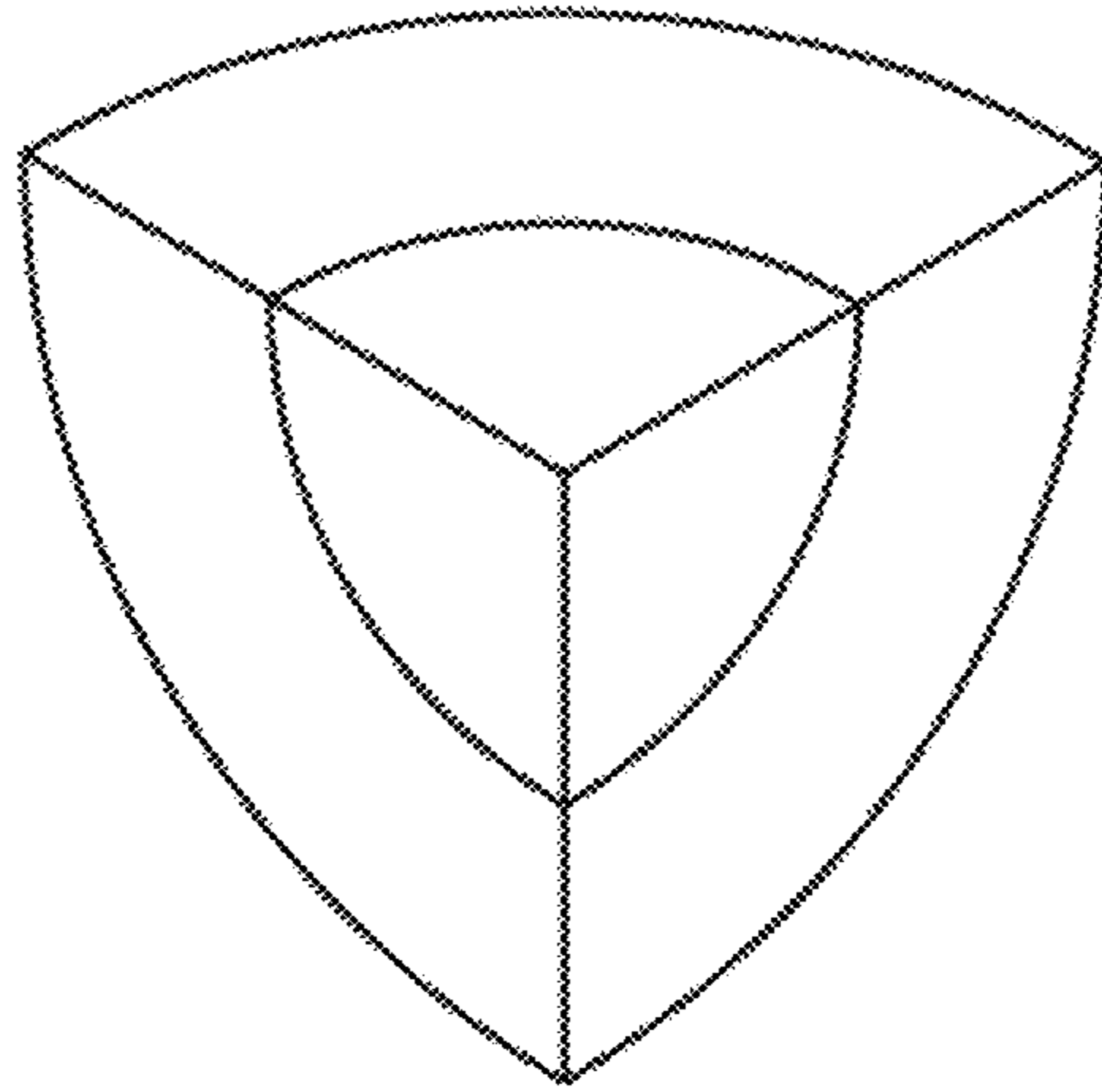

1.7

