

US00D964127S

(12) **United States Design Patent** (10) **Patent No.:** **US D964,127 S**  
**Hsieh** (45) **Date of Patent:** **\*\* Sep. 20, 2022**

(54) **HAND TOOL**

(71) Applicant: **KABO TOOL COMPANY**, Taichung (TW)

(72) Inventor: **Chih-Ching Hsieh**, Taichung (TW)

(73) Assignee: **KABO TOOL COMPANY**, Taichung (TW)

(\*\*) Term: **15 Years**

(21) Appl. No.: **29/758,340**

(22) Filed: **Nov. 13, 2020**

(51) **LOC (13) Cl.** ..... **08-05**

(52) **U.S. Cl.**  
USPC ..... **D8/21; D8/28; D8/29**

(58) **Field of Classification Search**  
USPC ..... D8/21, 25, 28, 29  
CPC .... B25B 13/06; B25B 13/065; B25B 23/0035  
See application file for complete search history.

(56) **References Cited**

**U.S. PATENT DOCUMENTS**

D287,333	S	*	12/1986	Knudson	.....	D8/71
D398,823	S	*	9/1998	Hsieh	.....	D8/29
D448,982	S	*	10/2001	Trempala	.....	D8/347
D472,434	S	*	4/2003	Trempala	.....	D8/387
D484,768	S	*	1/2004	Warfel	.....	D8/86
D506,908	S	*	7/2005	Hsien	.....	D8/29
D524,615	S	*	7/2006	Albertson	.....	D8/29
D526,172	S	*	8/2006	Lin	.....	D8/29
D570,169	S	*	6/2008	Lin	.....	D8/29
D597,809	S	*	8/2009	Hsieh	.....	D8/29
D709,343	S	*	7/2014	Huang	.....	D8/70
D709,744	S	*	7/2014	Kluhsman, Jr.	.....	D8/29
D745,813	S	*	12/2015	Hsieh	.....	D8/29
D745,814	S	*	12/2015	Hsieh	.....	D8/29

(Continued)

**OTHER PUBLICATIONS**

“Impact Nut and Bolt Extraction Tool Set, Rusted Damaged Stripped Nut and Bolt Remover Tool Kit” Amazon, Sep. 9, 2020, Accessed Mar. 2, 2022 URL:<https://www.amazon.com/Extraction-Damaged-Stripped-Remover-Extractor/dp/B08HPLNTX5> (Year: 2020).\*

(Continued)

*Primary Examiner* — Rachel A. Voorhies

*Assistant Examiner* — Benjamin D. Wannemacher

(74) *Attorney, Agent, or Firm* — Guice Patents PLLC

(57) **CLAIM**

The ornamental design for a hand tool, as shown and described.

**DESCRIPTION**

FIG. 1 is a perspective view of the first embodiment of the hand tool;

FIG. 2 is a front view of FIG. 1;

FIG. 3 is a rear view of FIG. 1;

FIG. 4 is a left side view of FIG. 1;

FIG. 5 is a right side view of FIG. 1;

FIG. 6 is a top view of FIG. 1;

FIG. 7 is a bottom view of FIG. 1;

FIG. 8 is an enlarged view according to FIG. 6 showing the opening;

FIG. 9 is a perspective view of the second embodiment of the hand tool;

FIG. 10 is a front view of FIG. 9;

FIG. 11 is a rear view of FIG. 9;

FIG. 12 is a left side view of FIG. 9;

FIG. 13 is a right side view of FIG. 9;

FIG. 14 is a top view of FIG. 9; and,

FIG. 15 is a bottom view of FIG. 9.

The broken lines shown on the drawings are included for the purpose of illustrating portions of the hand tool that form no part of the claimed design.

**1 Claim, 9 Drawing Sheets**

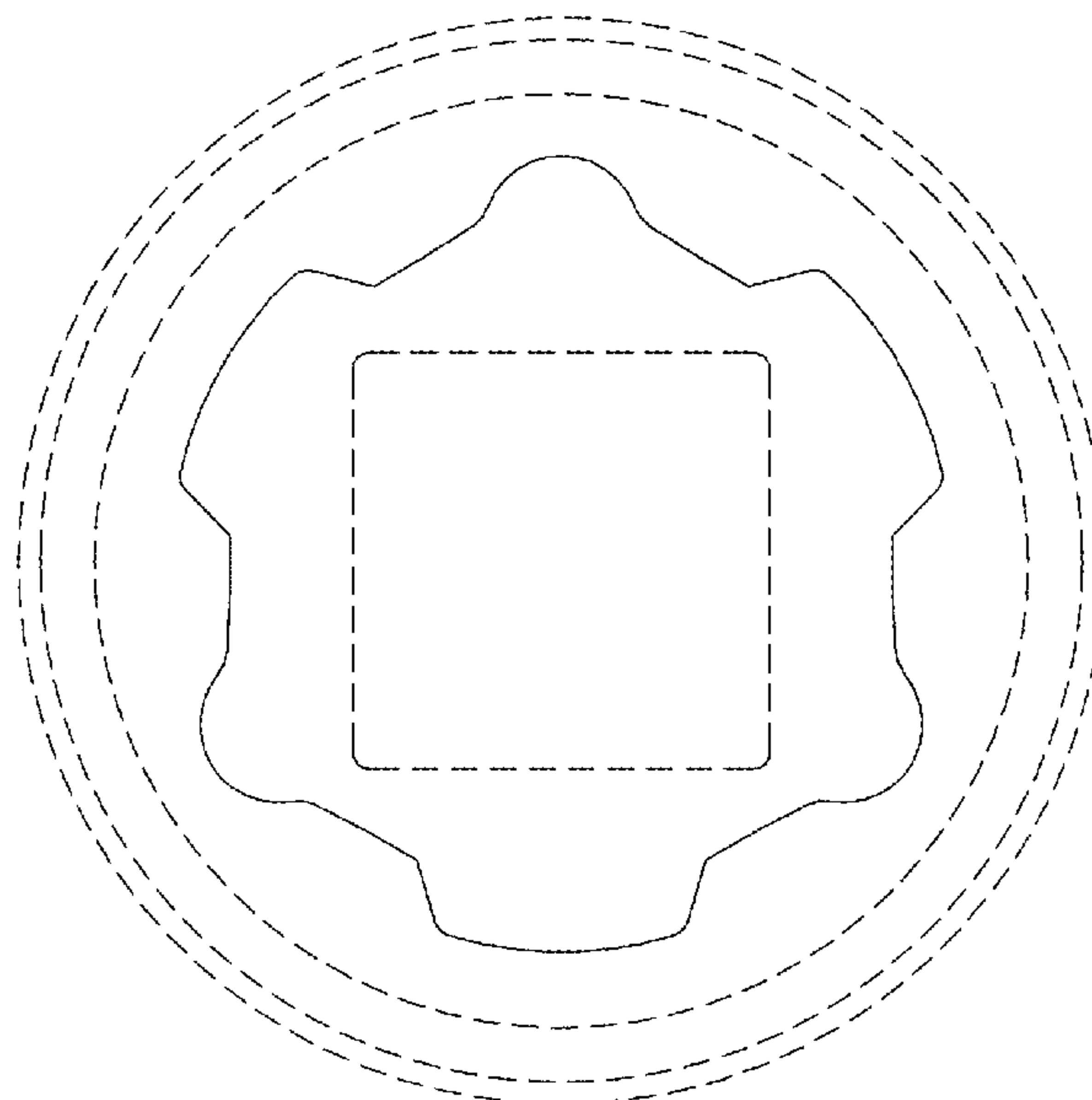

(56)

**References Cited**

U.S. PATENT DOCUMENTS

D749,388 S \* 2/2016 Lee ..... D8/29  
D773,266 S \* 12/2016 Hsieh ..... D8/27

OTHER PUBLICATIONS

“KABO Tools VNH0073 Non-Slip Shallow Socket Set”, amazon.co.jp; Sep. 13, 2019; Accessed Mar. 9, 2022; URL:<<https://www.amazon.co.jp/-/en/VNH0073-Non-Slip-Shallow-Socket-14-Piece/dp/B07XYTW9WL?th=1>> (Year: 2019).\*

\* cited by examiner

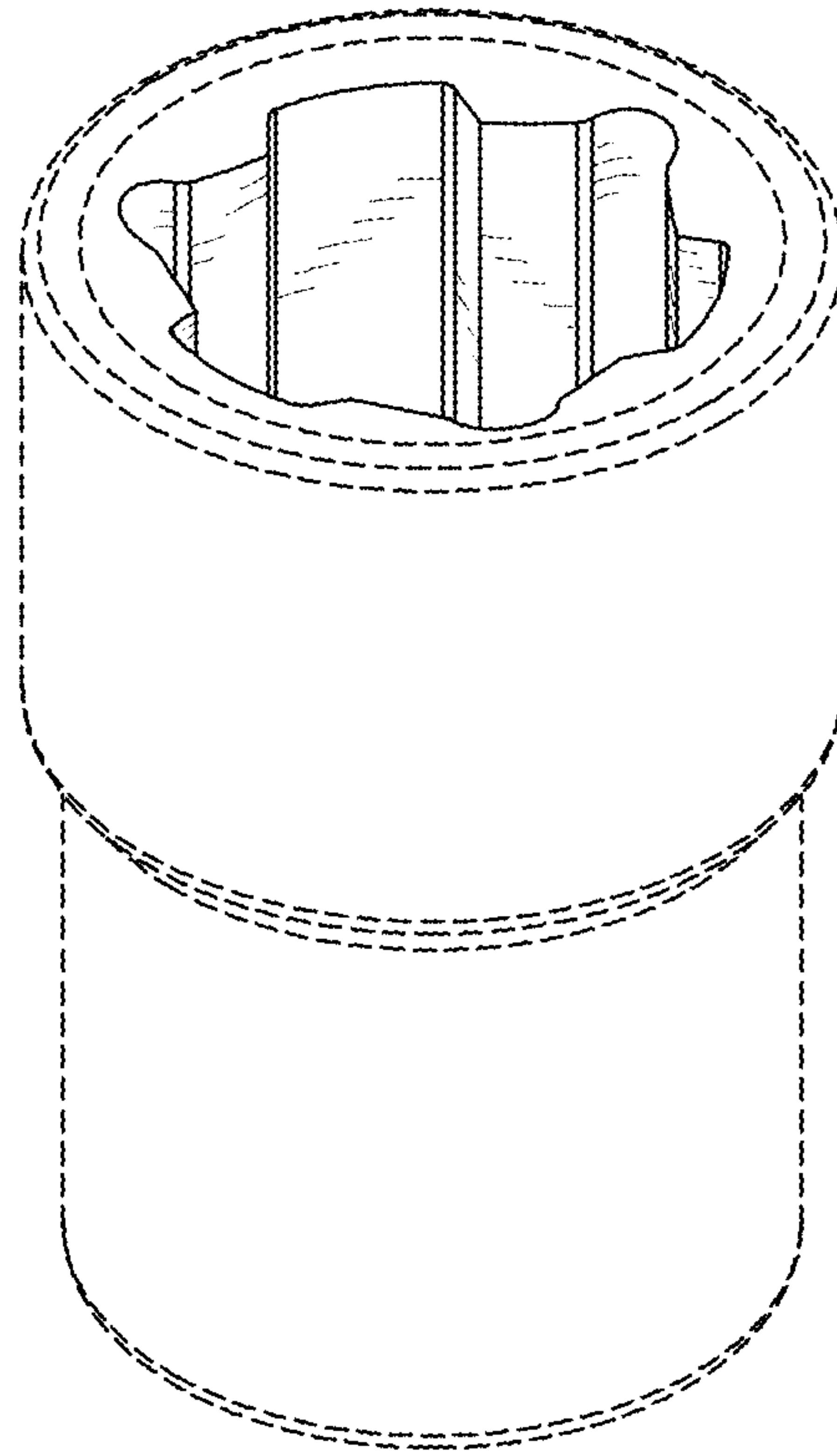

Fig. 1

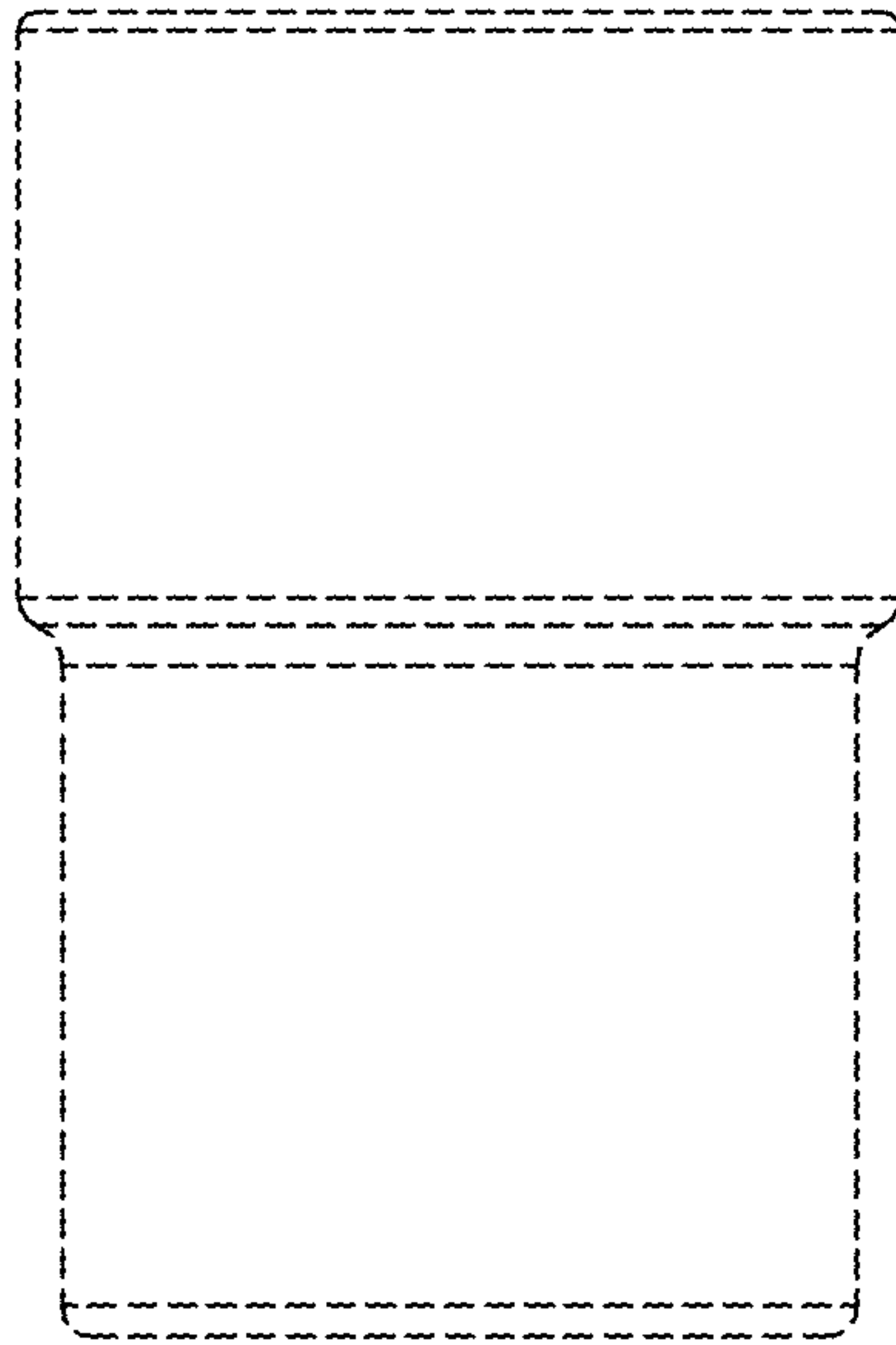

Fig. 2

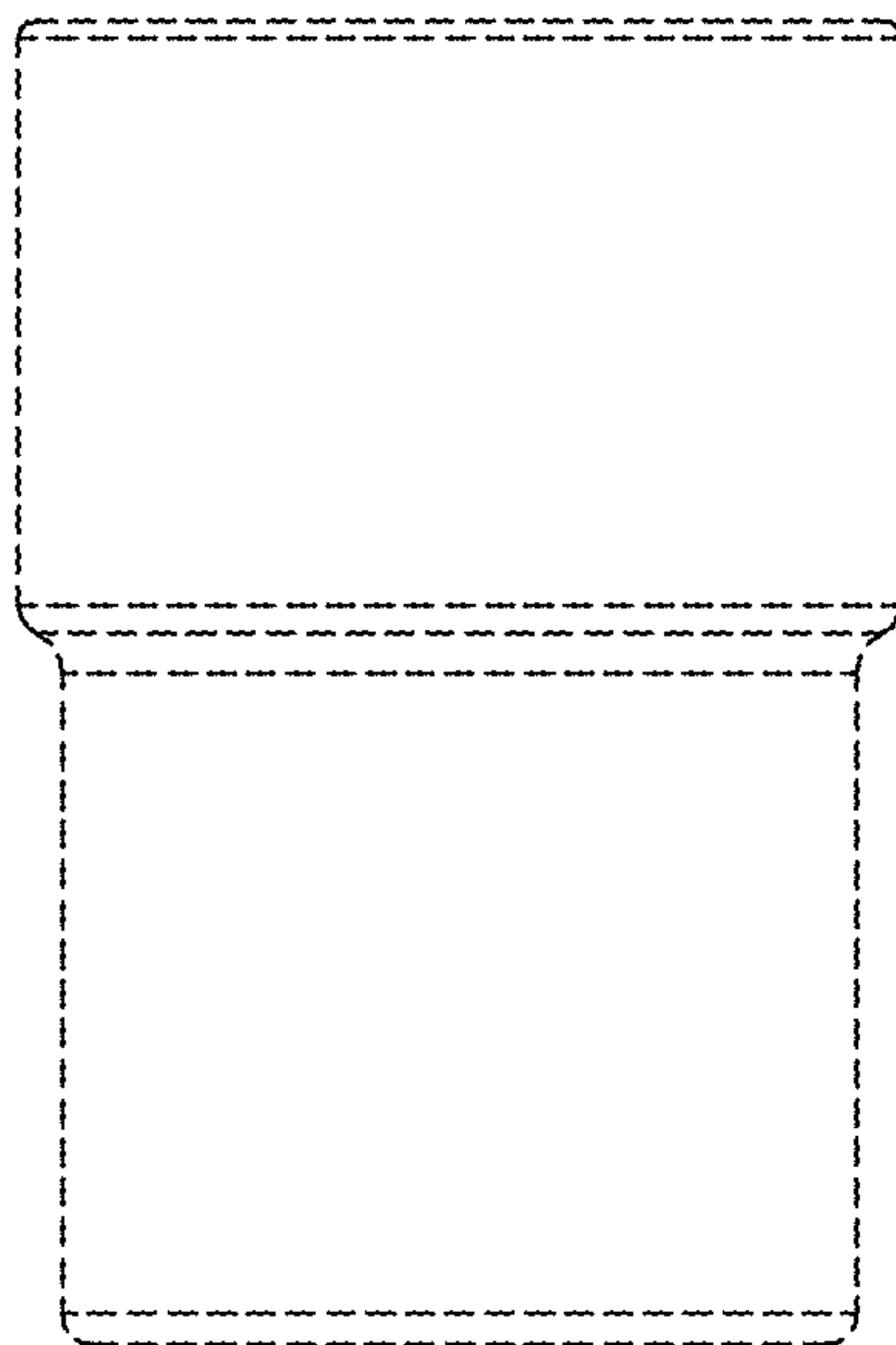

Fig. 3

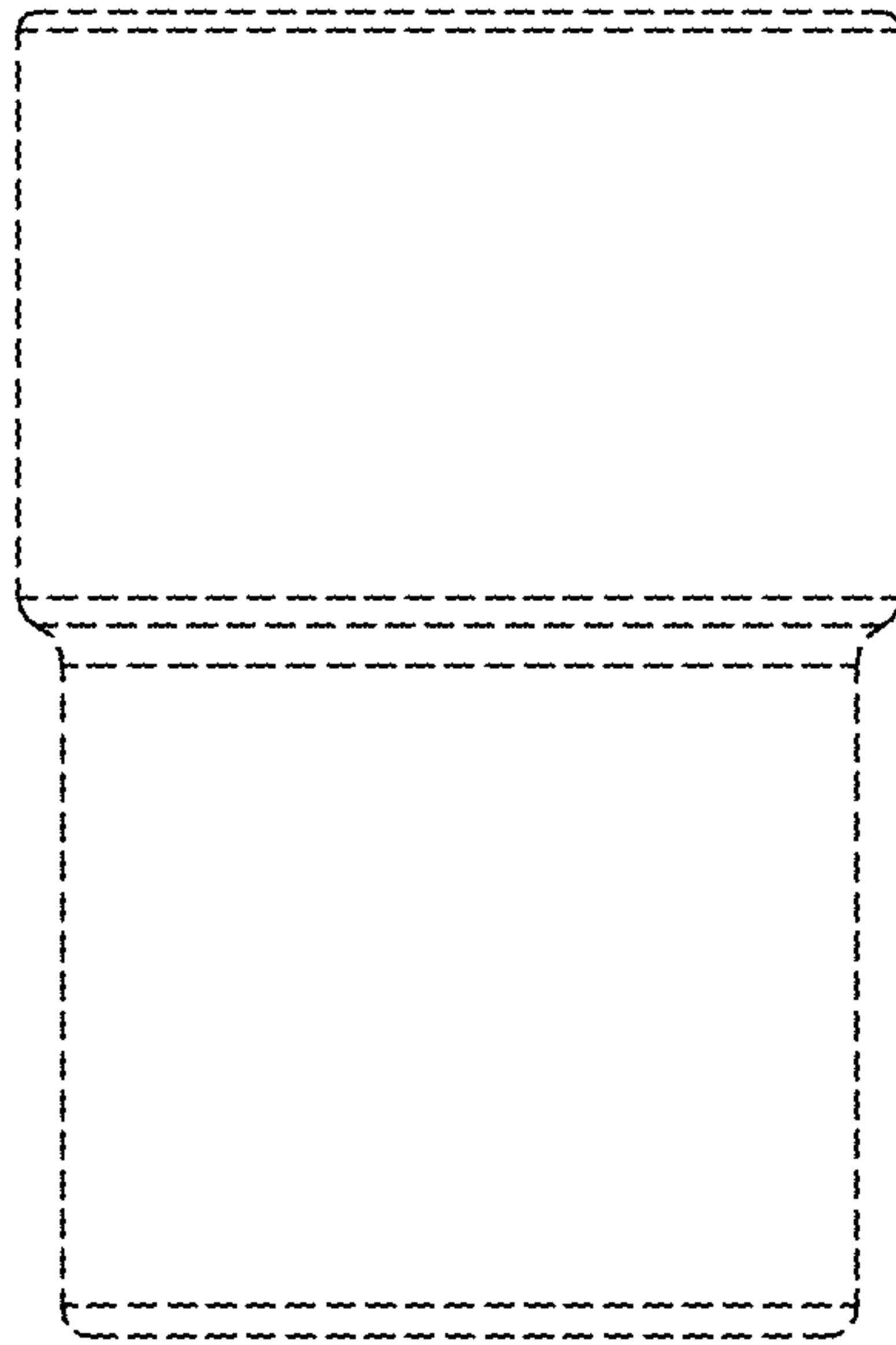

Fig. 4

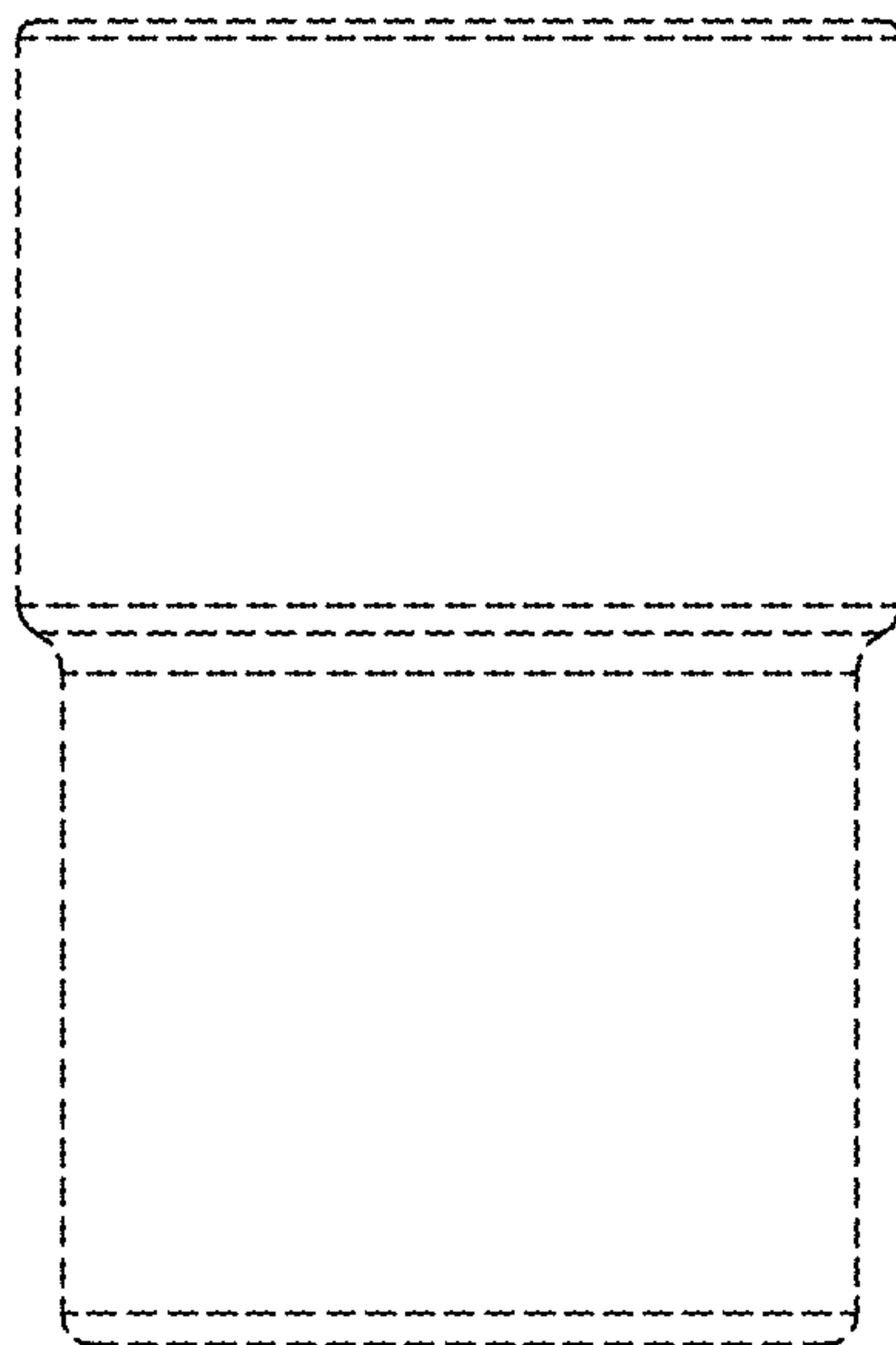

Fig. 5

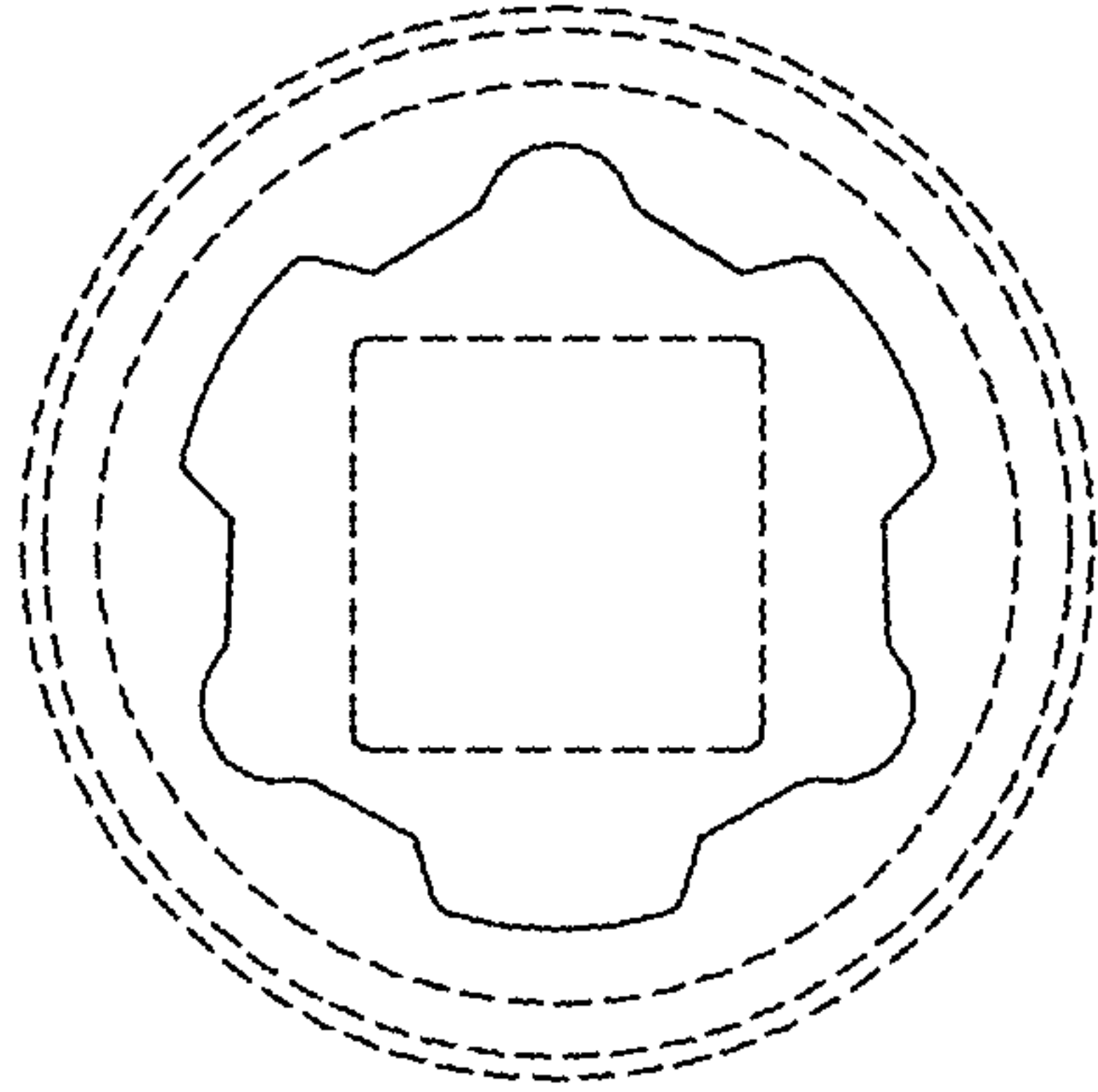

Fig. 6

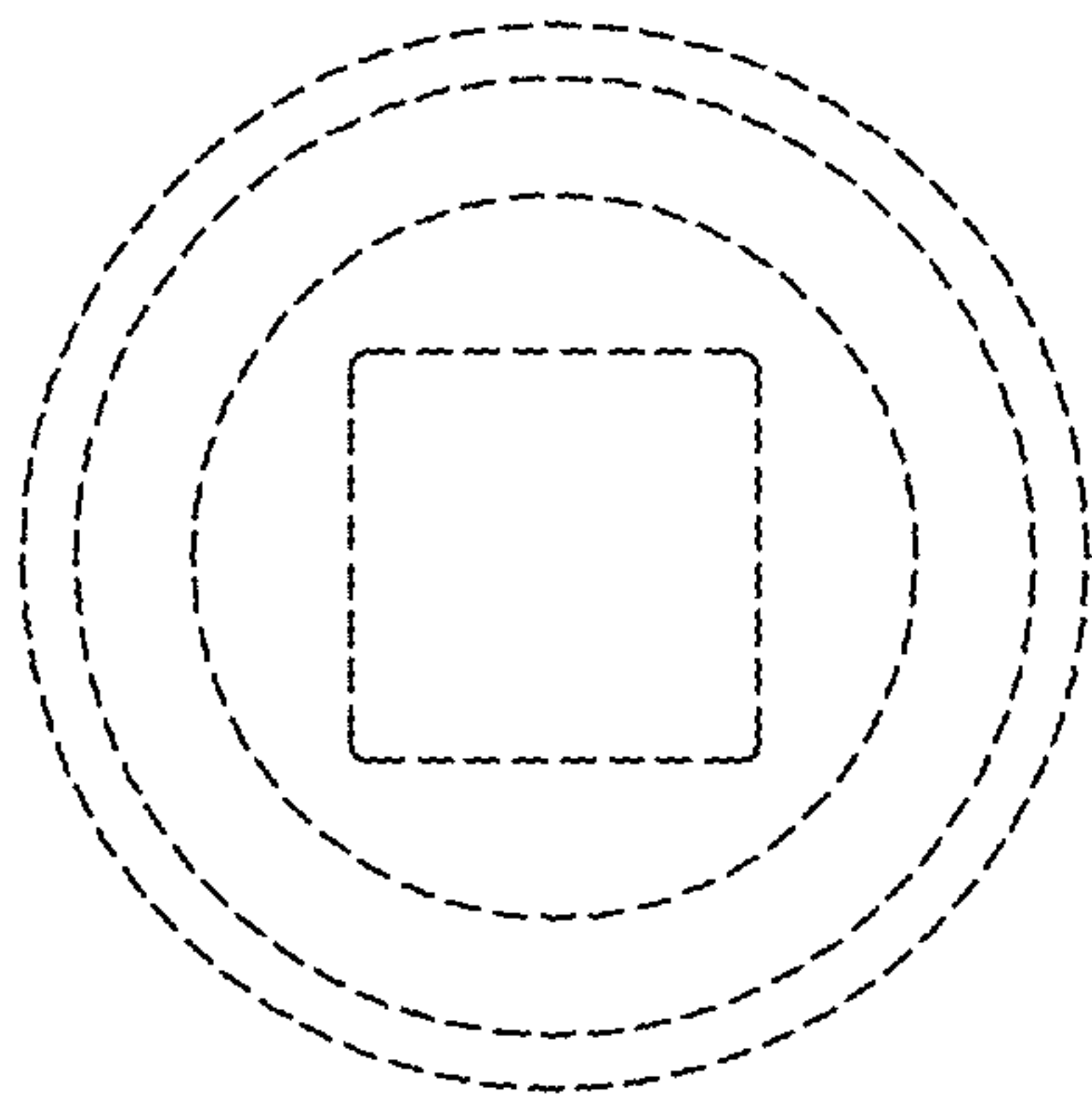

Fig. 7

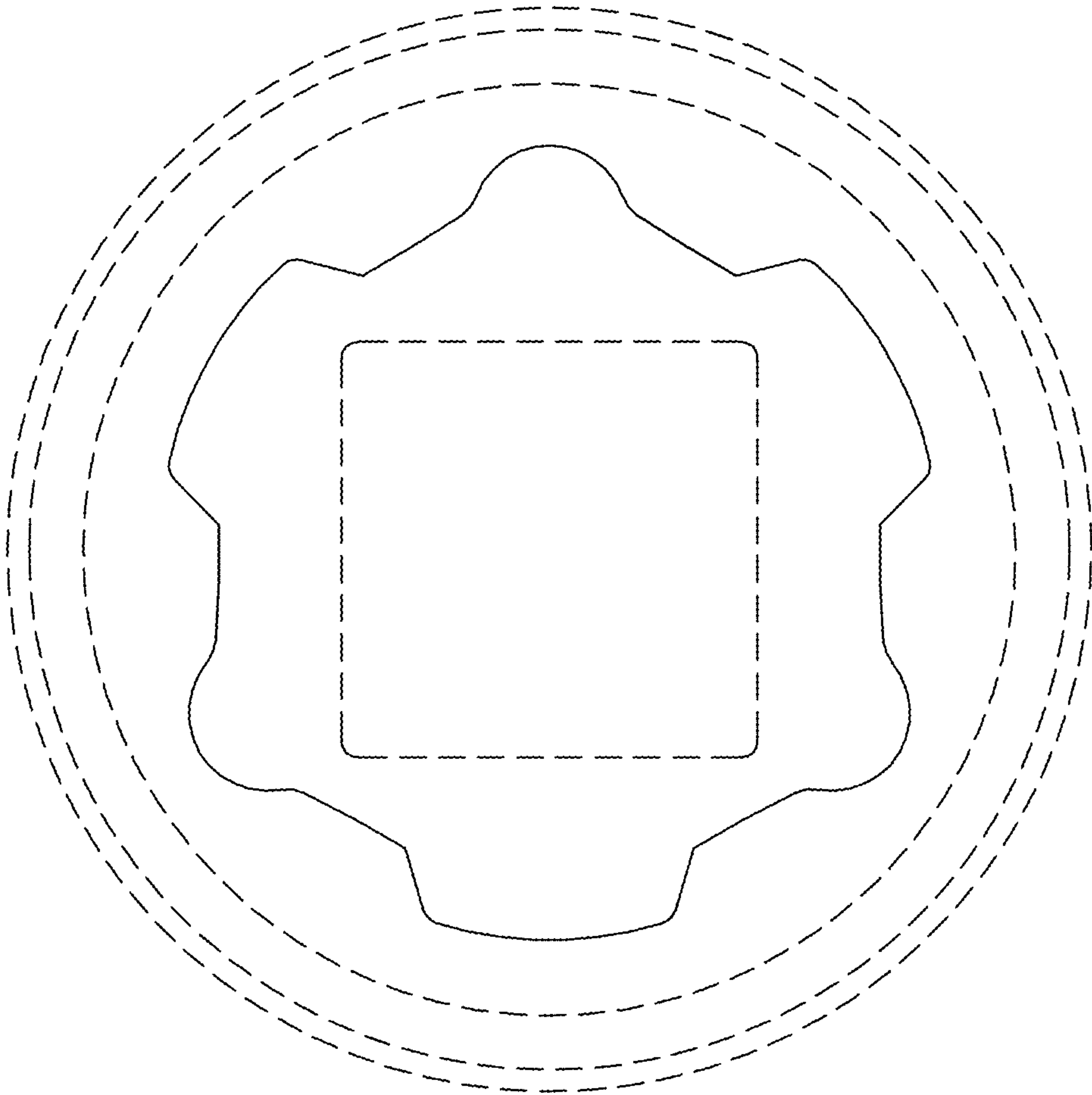

Fig. 8

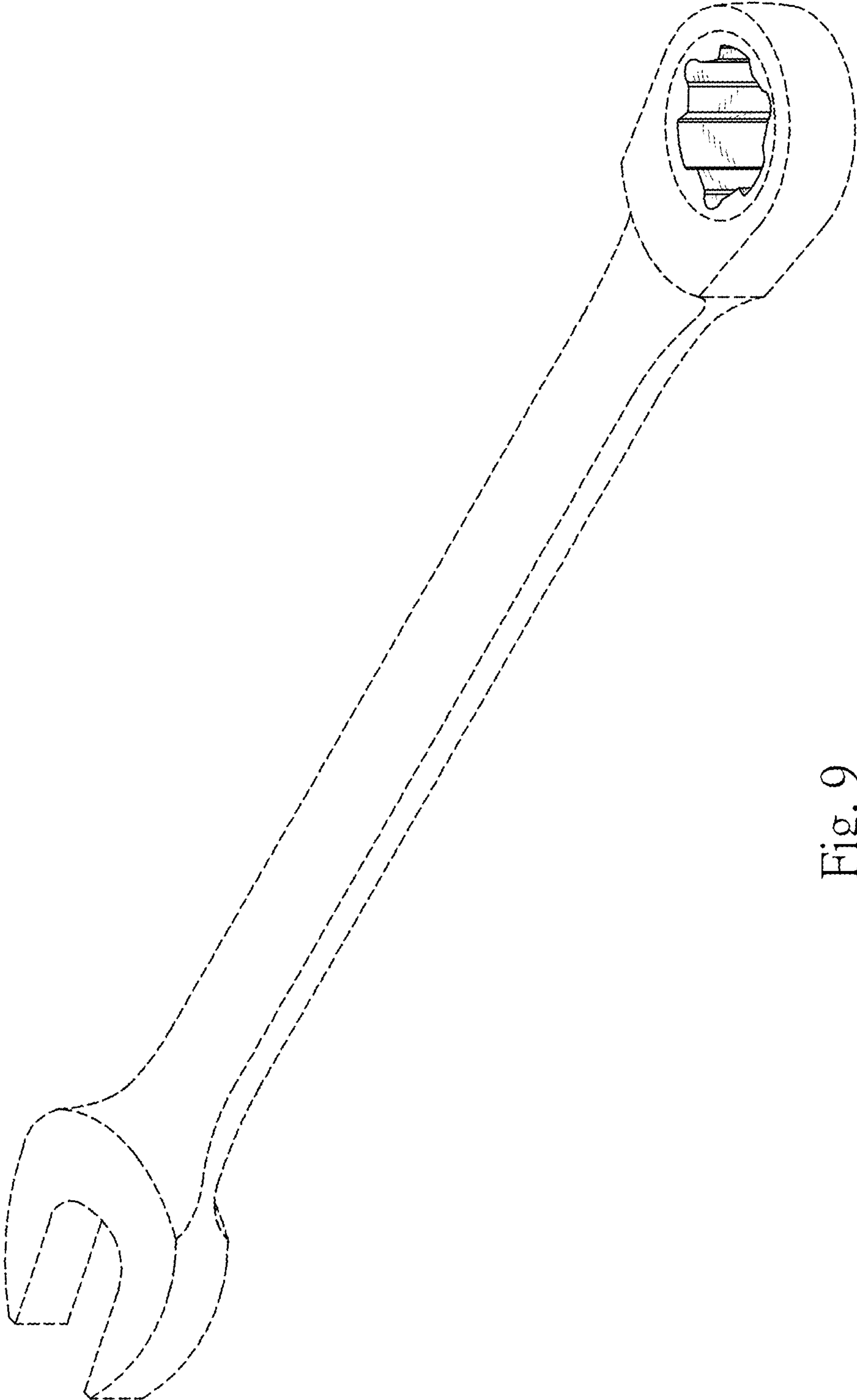

Fig. 9



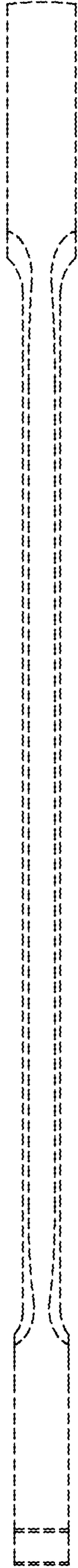

Fig. 10

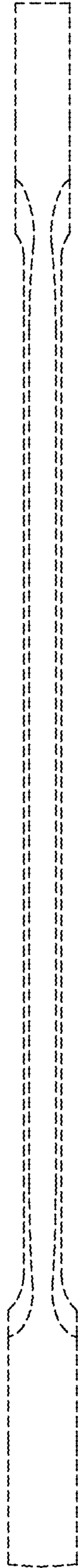

Fig. 11



Fig. 13



Fig. 12

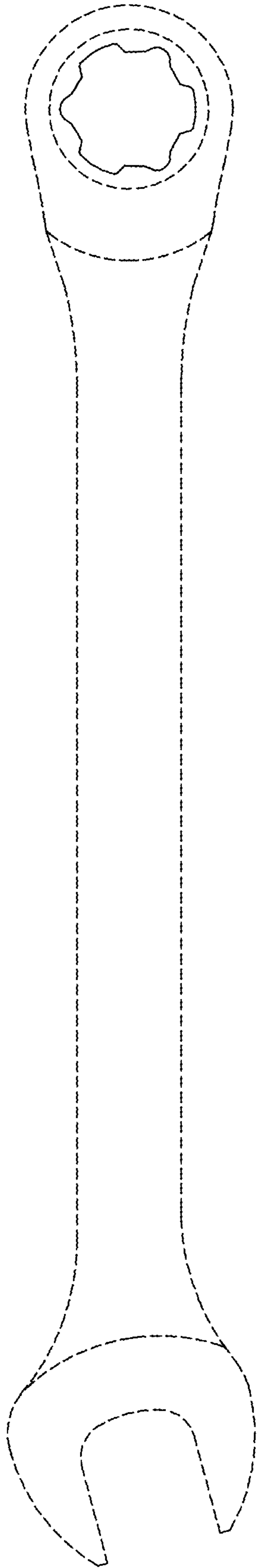

Fig. 14

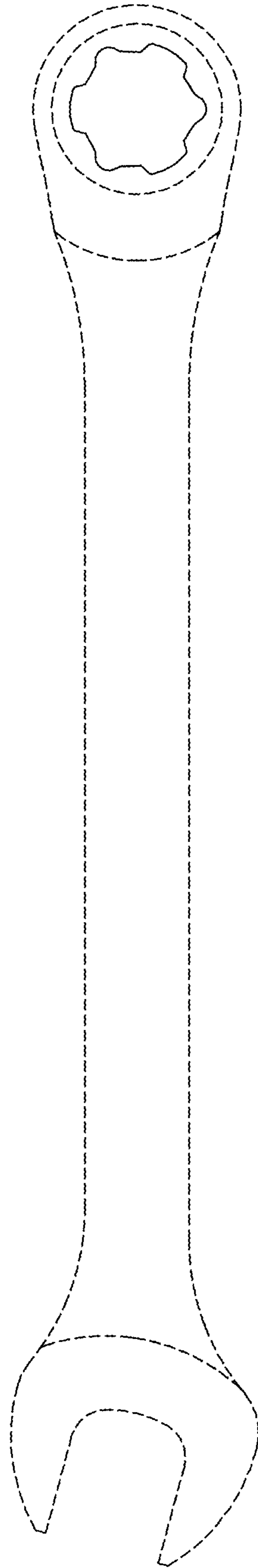

Fig. 15