



US00D964074S

(12) **United States Design Patent** (10) **Patent No.:** **US D964,074 S**  
**Xiao** (45) **Date of Patent:** **\*\* Sep. 20, 2022**

(54) **STORAGE BOX**

FOREIGN PATENT DOCUMENTS

(71) Applicant: **TAIZHOU SUKK FURNITURE CO., LTD**, Taizhou (CN)

CA 188782 \* 12/2020  
GB 9007116611-0002 \* 10/2019  
GB 9007116611-0011 \* 10/2019

(72) Inventor: **Shuangshuang Xiao**, Taizhou (CN)

(73) Assignee: **TAIZHOU SUKK FURNITURE CO., LTD**, Taizhou (CN)

OTHER PUBLICATIONS

(\*\*) Term: **15 Years**

Bluu 120 Gallon Outdoor Deck Box Storage, first available Nov. 5, 2020, amazon.com [online], [site visited Nov. 18, 2021], Available at URL: [https://www.amazon.com/BLUU-Furniture-Equipment-Water-resistant-Included/dp/B08MTBXR9K/ref=dp\\_fod\\_3?pd\\_rd\\_i=B08MTBXR9K&psc=1](https://www.amazon.com/BLUU-Furniture-Equipment-Water-resistant-Included/dp/B08MTBXR9K/ref=dp_fod_3?pd_rd_i=B08MTBXR9K&psc=1) (Year: 2020).\*

(21) Appl. No.: **29/718,658**

(Continued)

(22) Filed: **Dec. 27, 2019**

(51) **LOC (13) Cl.** ..... **06-04**

*Primary Examiner* — Jeffrey D Asch

(52) **U.S. Cl.**

*Assistant Examiner* — Caitlin A Lavery

USPC ..... **D6/667**

(58) **Field of Classification Search**

(57) **CLAIM**

USPC ..... D3/272–273, 276, 279, 281–282, 294;  
D6/334–337, 349, 352–353, 355, 370,  
D6/663–664, 667, 671

The ornamental design for a storage box, as shown and described.

CPC . A45C 11/00; A47F 3/00; A47F 3/005; B65D  
85/305; A47C 7/62; A47C 9/00–105;

**DESCRIPTION**

A47C 11/00; A47C 13/00; A47C 16/00;  
A47C 16/02; A47C 16/03; A47C 16/04;  
A47C 17/00; A47C 17/02; A47B 17/04;  
A47B 47/00; A47B 47/02; A47B 47/021;  
A47B 47/022; A47B 47/024; A47B  
47/03; A47B 47/04; A47B 47/042; A47B  
47/05; A47B 67/00; A47B 67/02; A47B  
67/04; A47B 83/04; A47B 88/00; A47B  
88/48; A47B 88/57; A47B 88/75; A47B  
88/90; A47B 88/427; A47B 88/941;

FIG. 1 is a perspective view of a storage box showing my new design;  
FIG. 2 is a second perspective view thereof;  
FIG. 3 is a front elevational view thereof;  
FIG. 4 is a rear elevational view thereof;  
FIG. 5 is a left side elevational view thereof;  
FIG. 6 is a right side elevational view thereof;  
FIG. 7 is a top plan view thereof;  
FIG. 8 is a bottom plan view thereof;  
FIG. 9 is a perspective view of the storage box of FIG. 1 shown in a second state for clarity of disclosure;  
FIG. 10 is an enlarged view of a circled portion 10 of FIG. 1; and,  
FIG. 11 is an enlarged view of a circled portion 11 of FIG. 2.

(Continued)

The broken lines in the drawings depict portions of the storage box that form no part of the claimed design.

(56) **References Cited**

U.S. PATENT DOCUMENTS

1,275,671 A \* 8/1918 Gardner ..... A47C 9/08  
312/190  
D168,205 S \* 11/1952 Baustian ..... D3/272

(Continued)

**1 Claim, 11 Drawing Sheets**

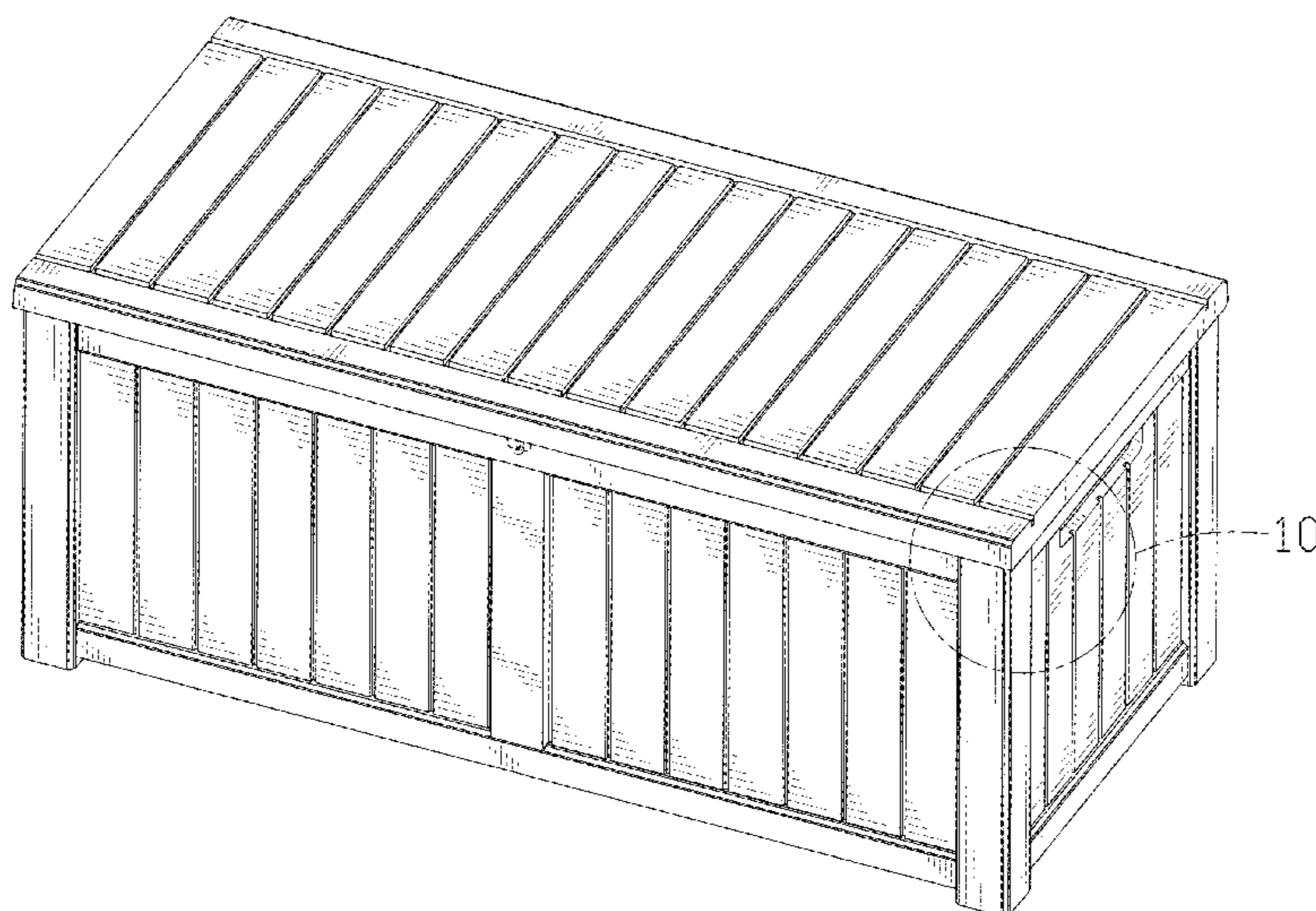

(58) **Field of Classification Search**

CPC .... A47B 7/00; A47B 7/01; A47B 7/02; A47B  
 46/00; A47B 55/00; A47B 81/00; A47B  
 81/002; A47B 81/007; A47B 81/02; A47B  
 43/00; A47B 49/006; A47B 87/00; A47B  
 87/002; A47B 87/008; A47B 87/0215;  
 A47B 96/022; A47B 96/02

See application file for complete search history.

(56) **References Cited**

U.S. PATENT DOCUMENTS

D295,470	S	*	5/1988	Uredat-Neuhoff	.....	D6/667
D389,646	S	*	1/1998	Sankey	.....	D3/294
D421,181	S	*	2/2000	Tisbo	.....	D3/273
D428,717	S	*	8/2000	Solowiej	.....	D6/349
D429,418	S	*	8/2000	Tisbo	.....	D25/16
D444,626	S	*	7/2001	Anderson	.....	D3/273
D493,302	S	*	7/2004	Sabo	.....	D6/667
D510,802	S	*	10/2005	Sagol	.....	D3/273
D593,773	S	*	6/2009	Richardson	.....	D6/667
D641,182	S	*	7/2011	Guy	.....	D6/664
8,689,992	B2	*	4/2014	Anderson	.....	A47C 7/62 220/4.01
D715,048	S	*	10/2014	Donnelly	.....	D3/273
D788,499	S	*	6/2017	Anderson	.....	D6/667
D805,311	S	*	12/2017	Mandon	.....	D6/349
D810,475	S	*	2/2018	Ben Avi	.....	D6/667
D858,145	S	*	9/2019	Herring	.....	D6/641
D870,494	S	*	12/2019	Leng	.....	D6/667
D872,996	S	*	1/2020	Caldwell	.....	D3/272
D880,102	S	*	3/2020	Quinn	.....	D99/28
D880,906	S	*	4/2020	Leng	.....	D6/663
D880,907	S	*	4/2020	Leng	.....	D6/667
D881,613	S	*	4/2020	Leng	.....	D6/663
D903,317	S	*	12/2020	Kyte	.....	D3/272

D914,378	S	*	3/2021	Simonetti	.....	D6/336
D914,401	S	*	3/2021	Leng	.....	D6/667
D914,402	S	*	3/2021	Xiao	.....	D6/667
D914,403	S	*	3/2021	Xiao	.....	D6/667
D914,404	S	*	3/2021	Xiao	.....	D6/667
D915,766	S	*	4/2021	Su	.....	D3/272
D920,688	S	*	6/2021	Kilburn	.....	D6/336
D935,250	S	*	11/2021	Kopp	.....	D6/703.2
D937,610	S	*	12/2021	Phillips	.....	D6/667
D938,200	S	*	12/2021	Anderson	.....	D6/667
D945,799	S	*	3/2022	Anderson	.....	D6/667
D947,582	S	*	4/2022	Kopp	.....	D6/667
D954,476	S	*	6/2022	Kopp	.....	D6/667
2004/0200832	A1	*	10/2004	Moon	.....	B65D 11/1873 220/4.28
2005/0146255	A1	*	7/2005	Sabo	.....	A47B 67/00 312/316
2008/0157571	A1	*	7/2008	Richardson	.....	A47C 4/028 297/188.1
2019/0239650	A1	*	8/2019	Nelson	.....	E05B 65/52
2020/0263474	A1	*	8/2020	Leng	.....	A47B 67/00

OTHER PUBLICATIONS

285L Waterproof Bench Deck Box . . . , unknown first available date, alibaba.com [online], [site visited Nov. 18, 2021], Available at URL: [https://www.alibaba.com/product-detail/285L-Waterproof-Bench-Deck-Box-Garden\\_62320094528.html?spm=a2700.details.0.0.7c7c6c0eSMeoj5](https://www.alibaba.com/product-detail/285L-Waterproof-Bench-Deck-Box-Garden_62320094528.html?spm=a2700.details.0.0.7c7c6c0eSMeoj5) (Year: 2021).\*

119Gal/450L Plastic Waterproof Deck Box . . . , unknown first available date, alibaba.com [online], [site visited 11/1/8/21], Available at URL: [https://sukkgarden.en.alibaba.com/product/62427705777-813801753/119Gal\\_450L\\_Plastic\\_Waterproof\\_Deck\\_Box\\_Outdoor\\_Cushion\\_Garden\\_Storage\\_Box.html](https://sukkgarden.en.alibaba.com/product/62427705777-813801753/119Gal_450L_Plastic_Waterproof_Deck_Box_Outdoor_Cushion_Garden_Storage_Box.html) (Year: 2021).\*

\* cited by examiner

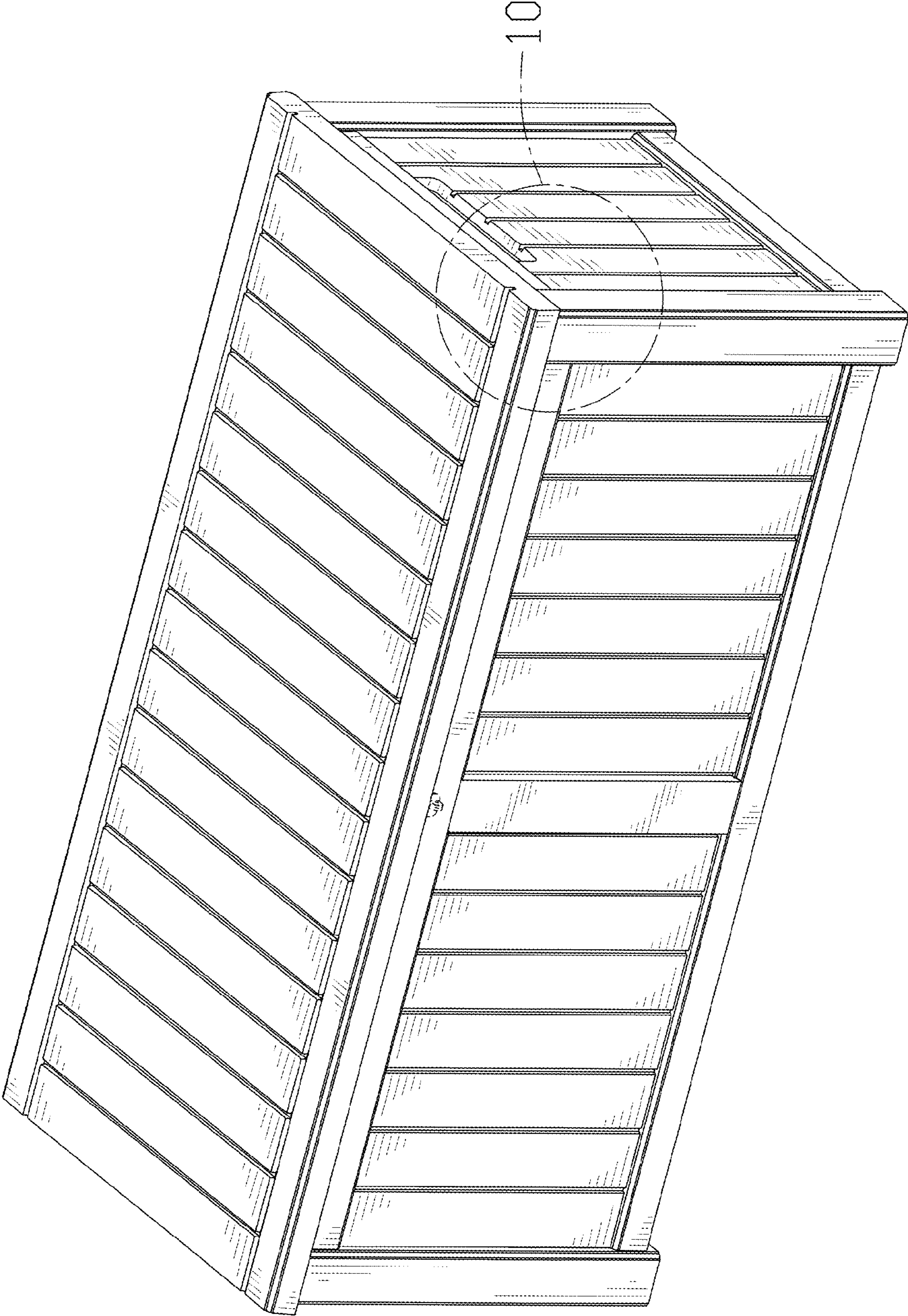

FIG. 1

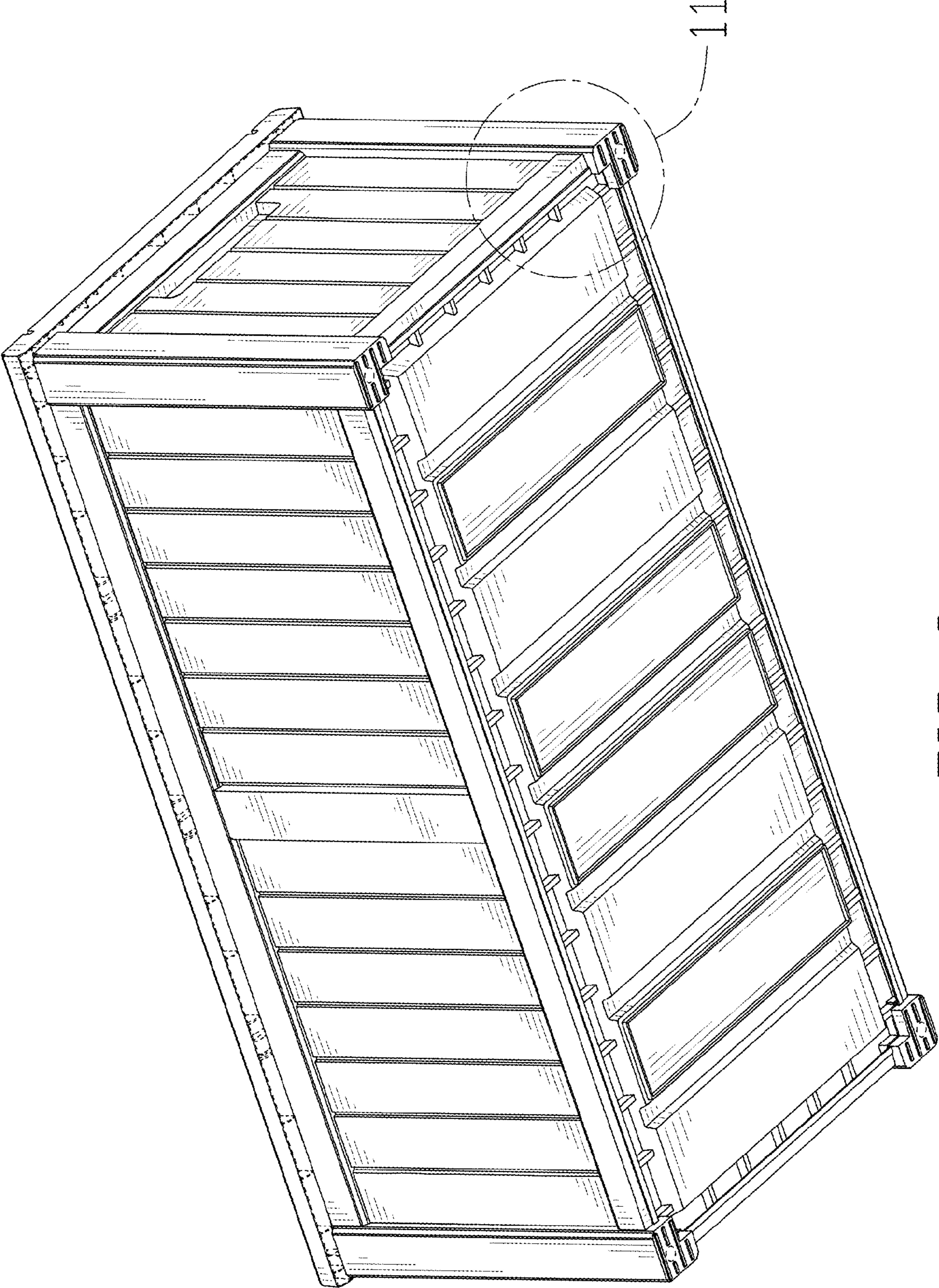

FIG. 2

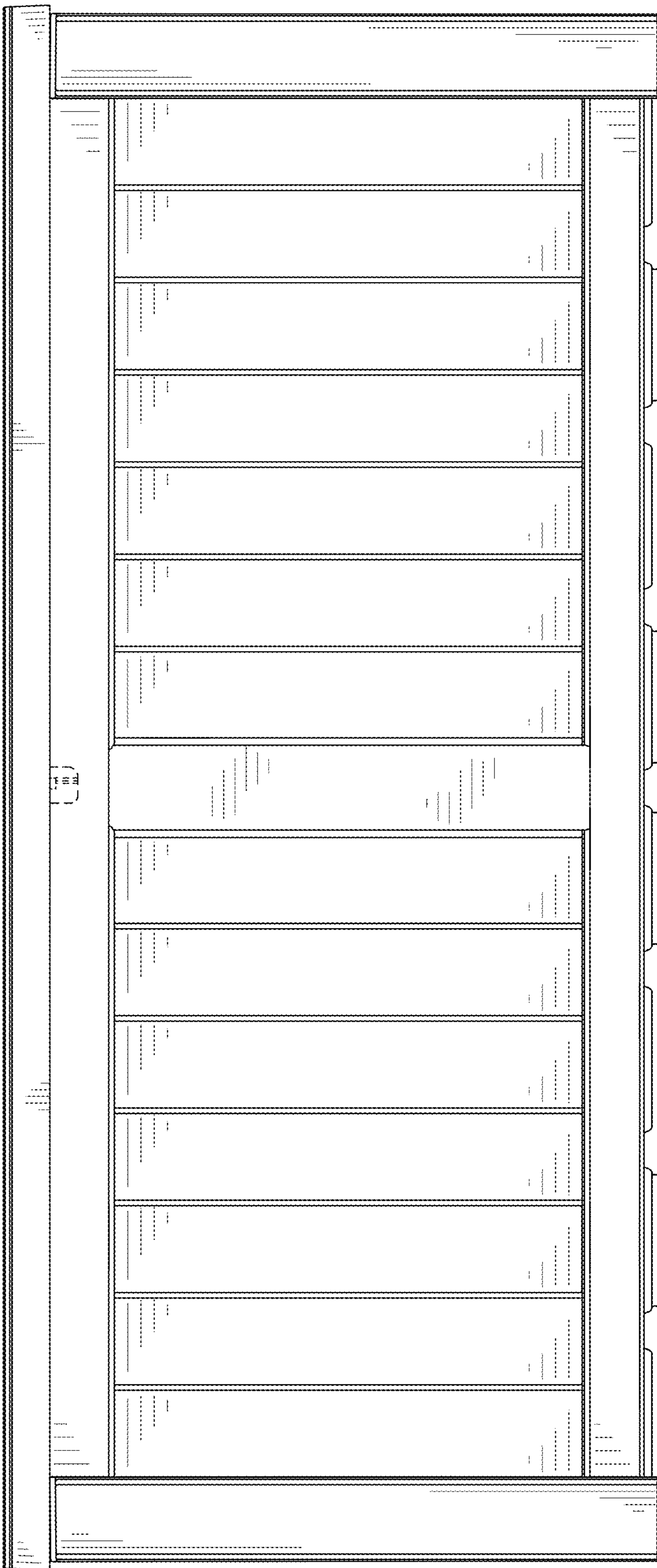

FIG. 3

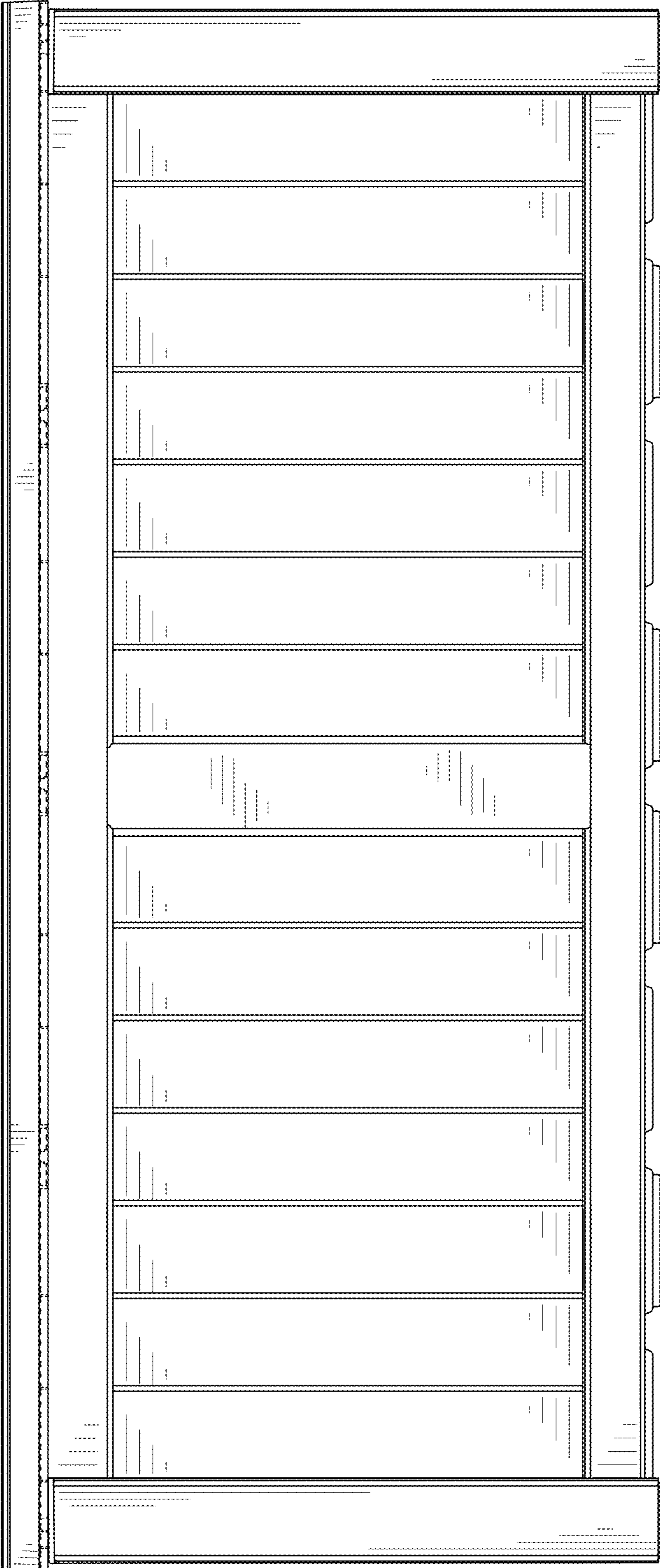

FIG. 4

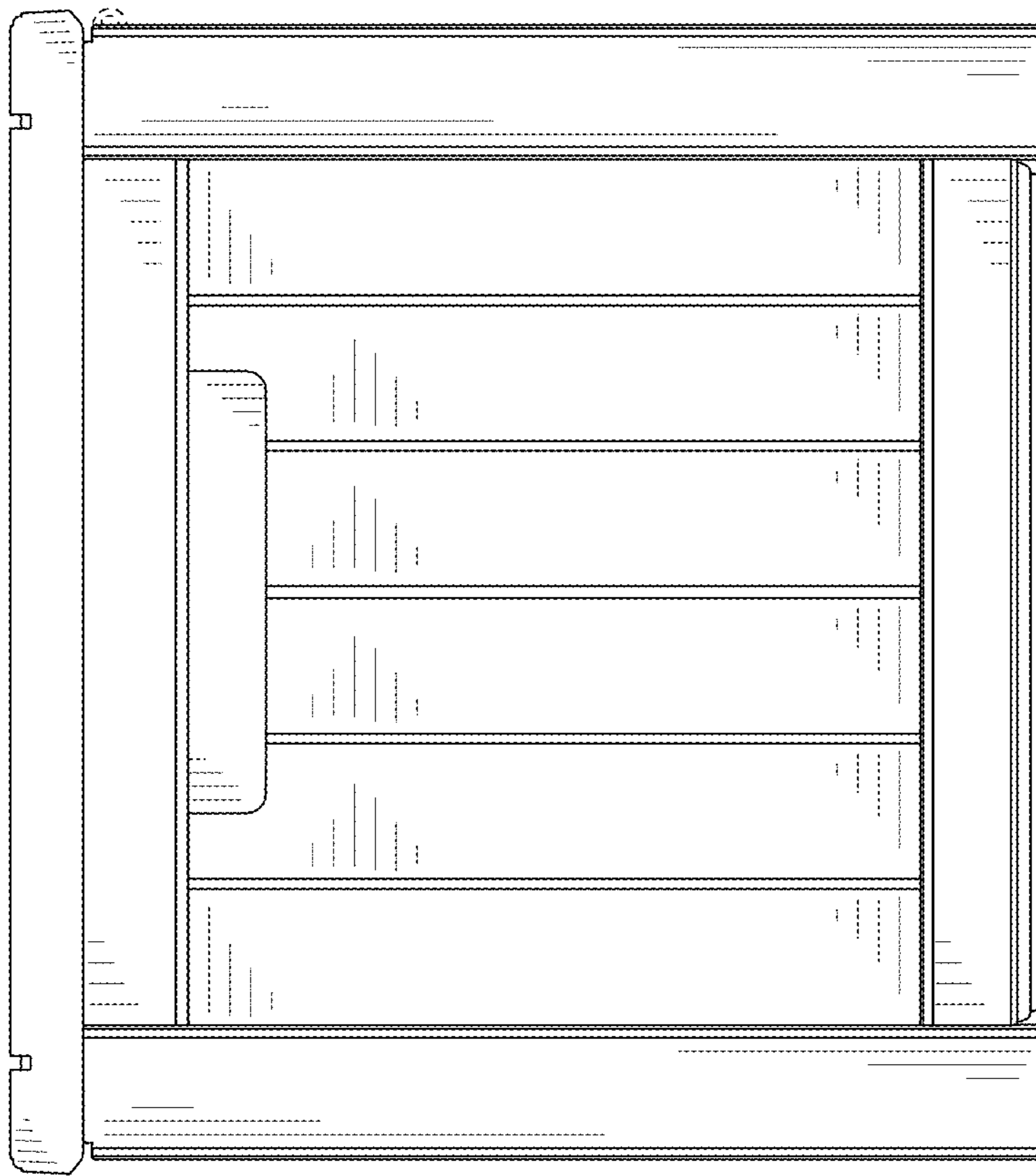

FIG. 5

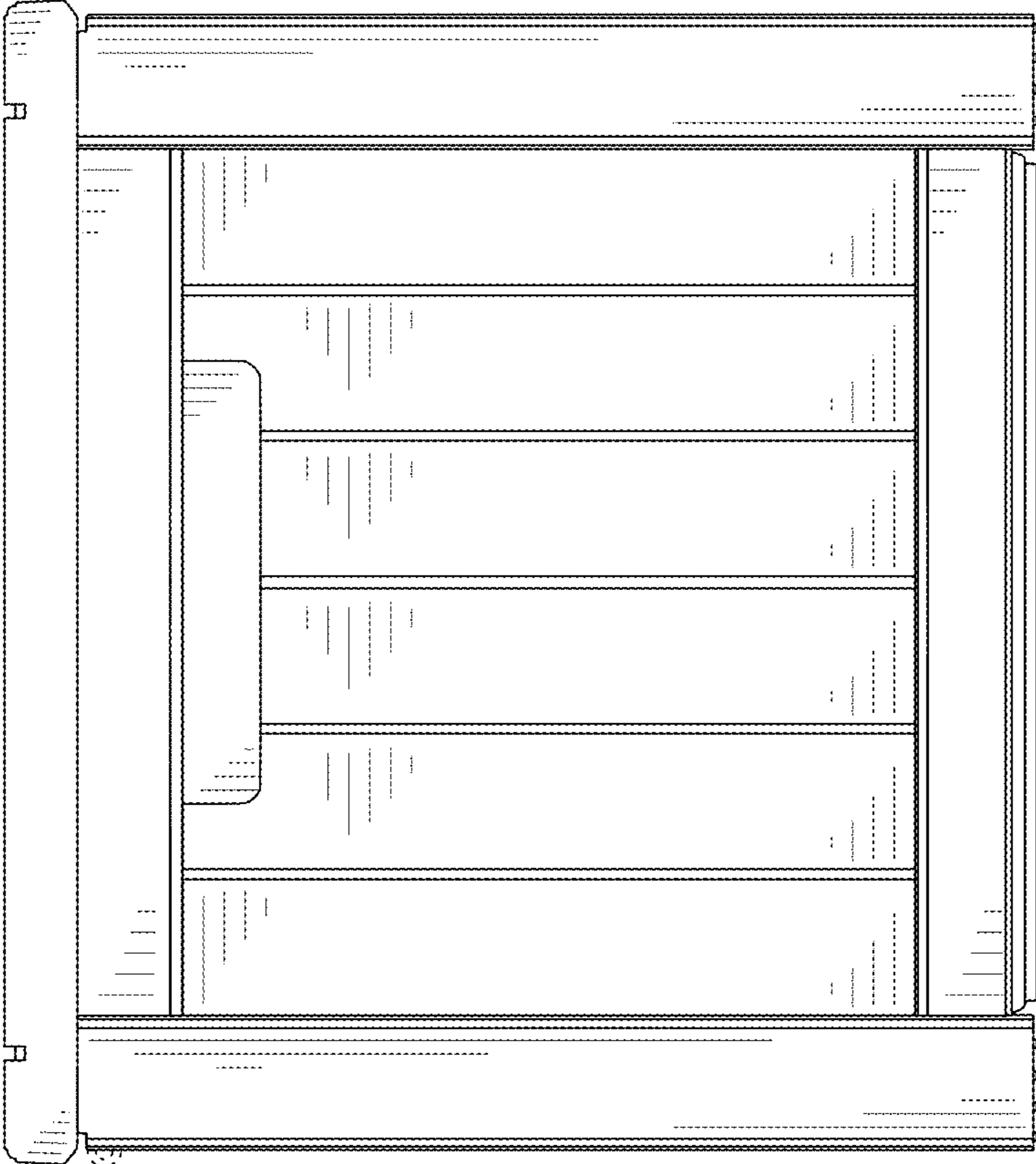

FIG. 6



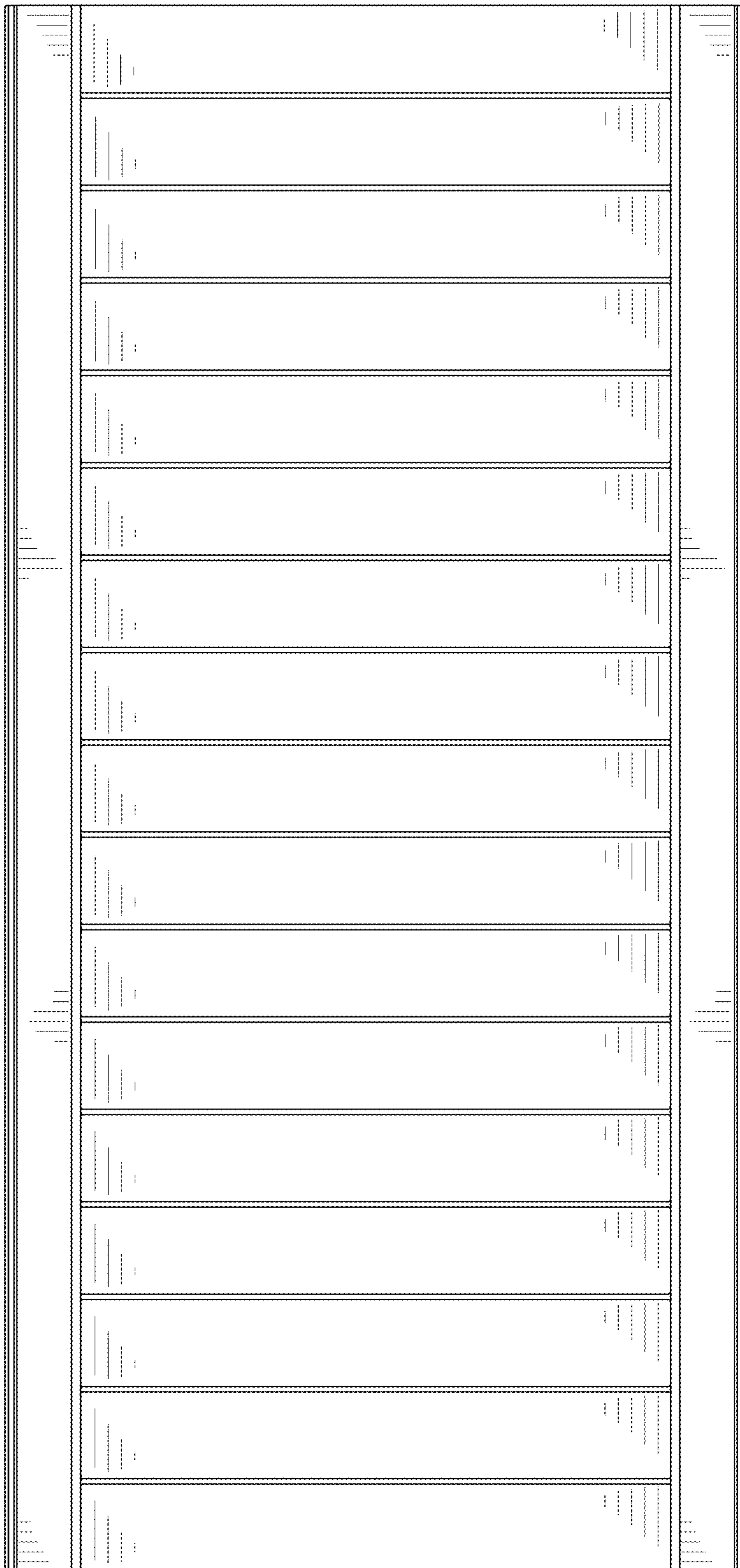

FIG. 7

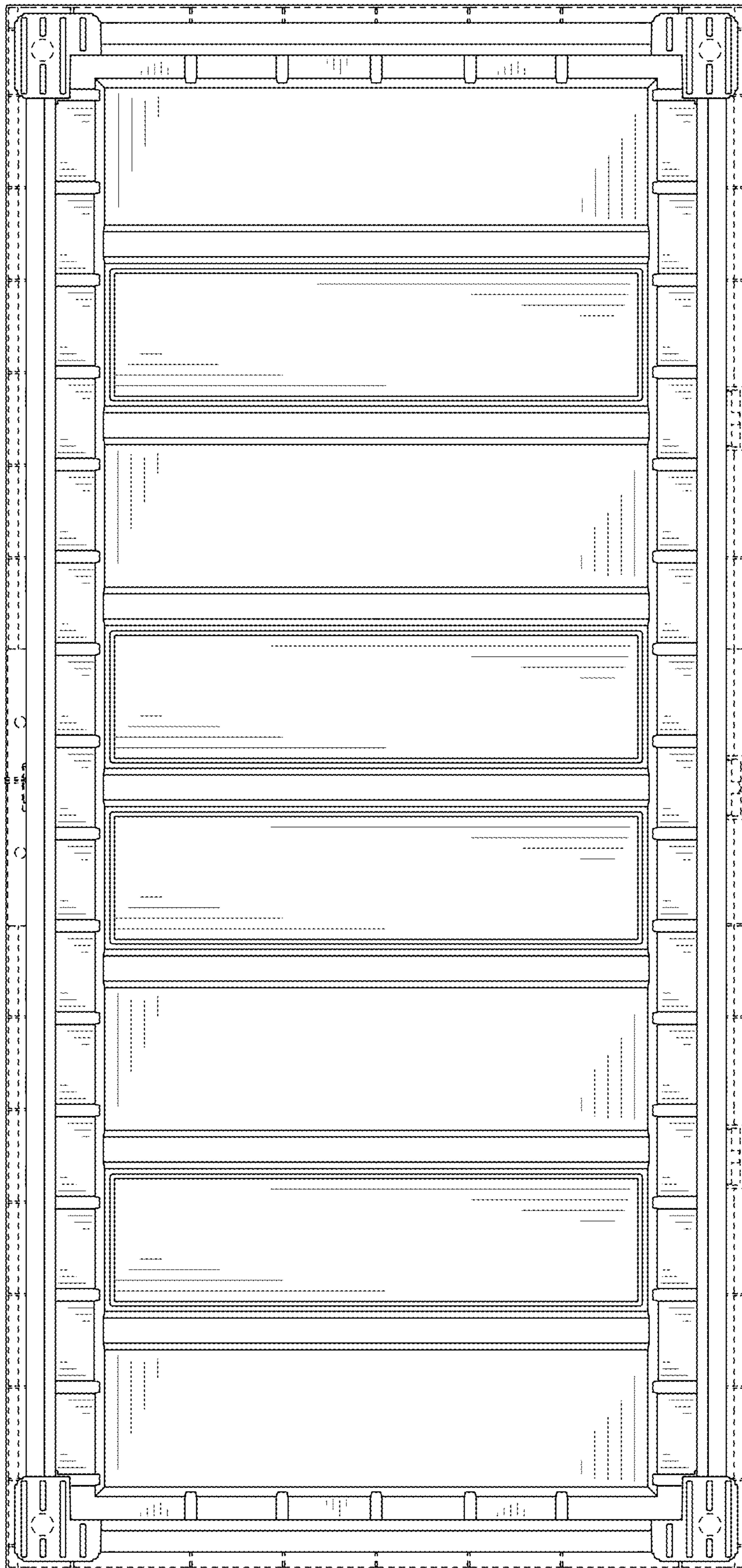

FIG. 8

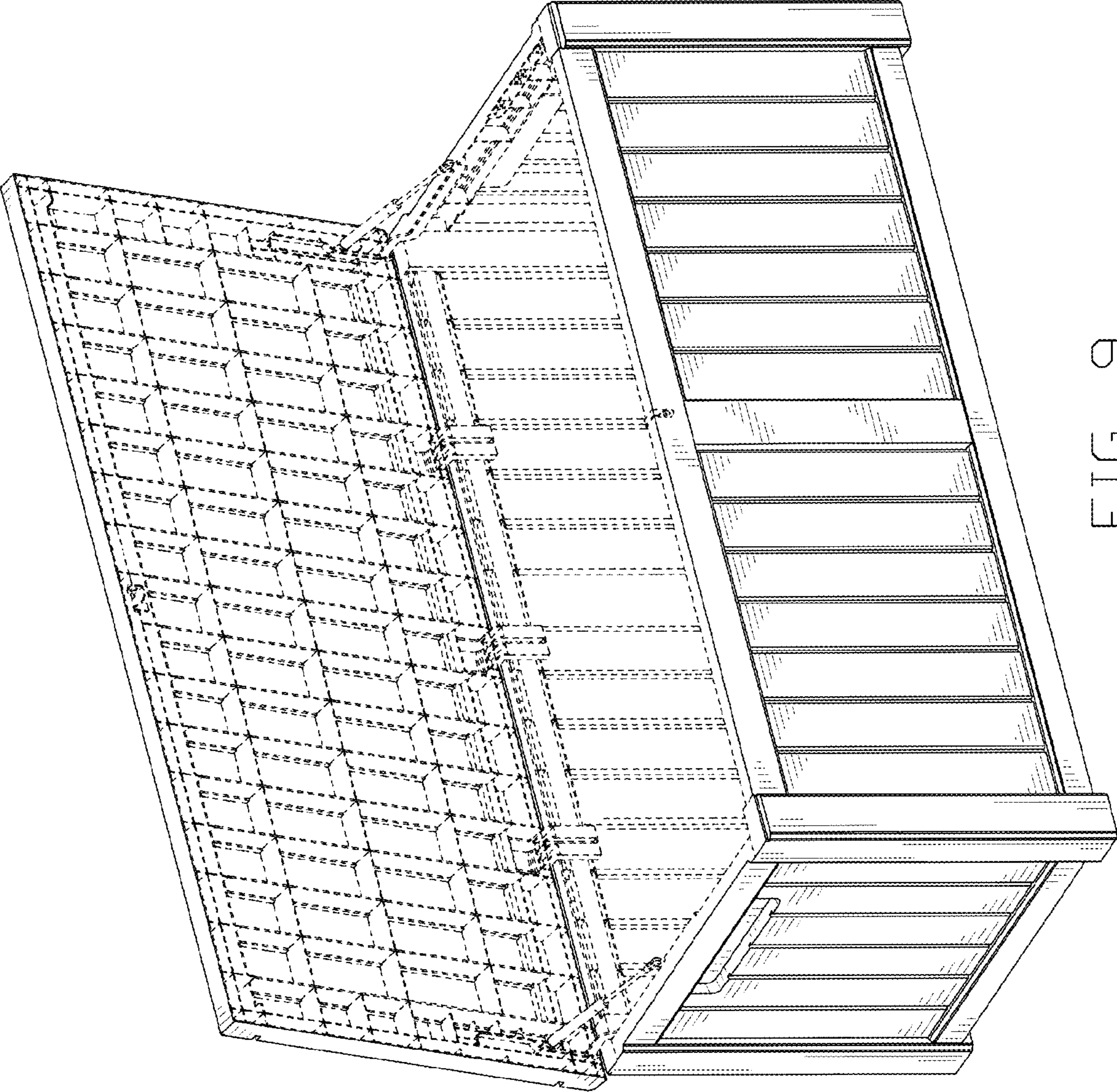

FIG. 9

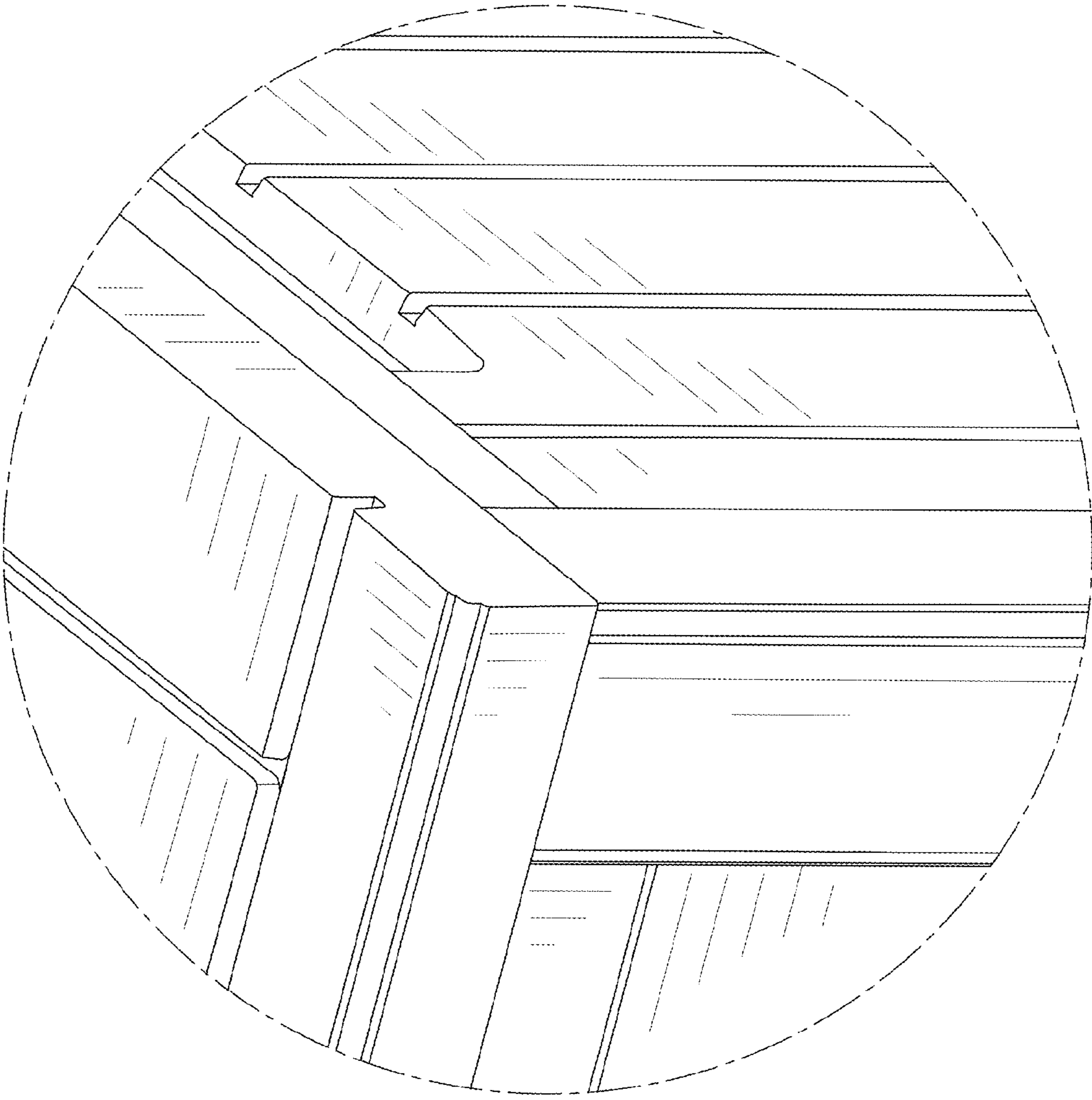

FIG. 10

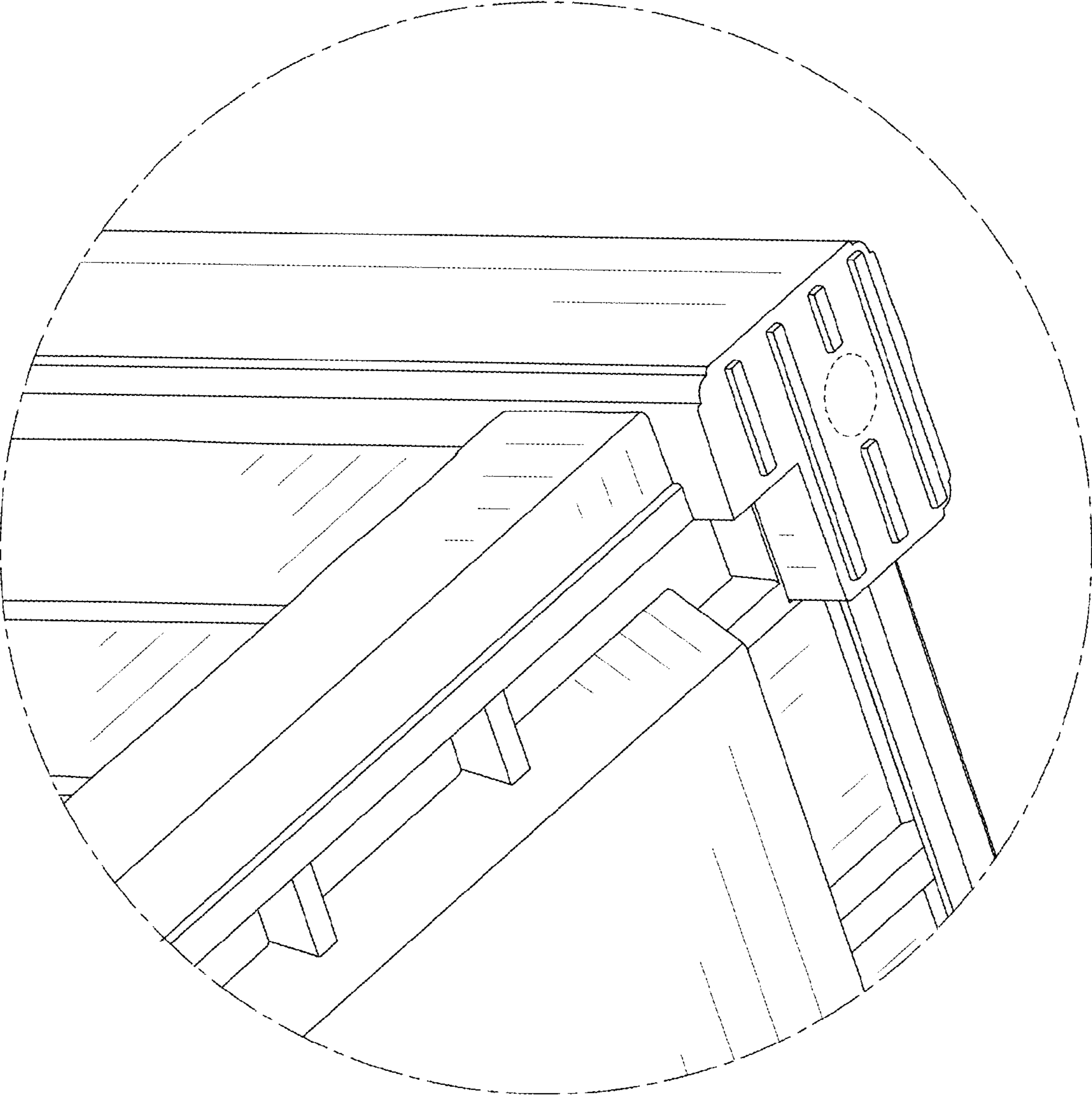

FIG. 11