



US00D964043S

(12) **United States Design Patent** (10) **Patent No.:** **US D964,043 S**
Gunness (45) **Date of Patent:** **** Sep. 20, 2022**

(54) **MAKEUP BRUSH HANDLE**
(71) Applicant: **Lumetique, Inc.**, Irvine, CA (US)
(72) Inventor: **Andrea Gunness**, Gallatin, TN (US)
(73) Assignee: **Lumetique, Inc.**, Irvine, CA (US)
(**) Term: **15 Years**
(21) Appl. No.: **29/716,019**
(22) Filed: **Dec. 5, 2019**
(51) **LOC (13) Cl.** **04-99**
(52) **U.S. Cl.**
USPC **D4/138**
(58) **Field of Classification Search**
USPC D4/100-138; D8/80, 83; D7/688
CPC .. A46B 9/00; A46B 9/02; A46B 9/025; A46B
9/021; A46B 9/04; A46B 2200/1046;
A46B 2200/1093; A46B 5/0095; Y10S
15/00; Y10S 15/10
See application file for complete search history.

(56) **References Cited**
U.S. PATENT DOCUMENTS
D764,701 S * 8/2016 Malhi D27/101
D794,965 S * 8/2017 Salm D4/138
D803,658 S * 11/2017 Perez D8/107
D814,197 S * 4/2018 Salm D4/138
(Continued)

OTHER PUBLICATIONS
Girl Meets Box, announced Jul. 2019 [online], [site visited Aug. 24, 2021]. Available from internet, URL: <https://www.girlmeetsbox.com/beautiac-subscription-box-review-july-2019/> (Year: 2019).*

Primary Examiner — George A Bugg
Assistant Examiner — Tamara L Hahn
(74) *Attorney, Agent, or Firm* — Element IP, PLC

(57) **CLAIM**
The ornamental design for a makeup brush handle, as shown and described.

DESCRIPTION
FIG. 1 is a front top three-dimensional view of the first embodiment of my new design;
FIG. 2 is a rear top three-dimensional view thereof;
FIG. 3 is a front elevation view thereof;
FIG. 4 is a rear elevation view thereof;
FIG. 5 is a right side elevation view thereof;
FIG. 6 is a top plan view thereof;
FIG. 7 is a bottom plan view thereof;
FIG. 8 is a front top three-dimensional view of the second embodiment of my new design;
FIG. 9 is a rear top three-dimensional view thereof;
FIG. 10 is a front elevation view thereof;
FIG. 11 is a rear elevation view thereof;
FIG. 12 is a right side elevation view thereof;
FIG. 13 is a top plan view thereof;
FIG. 14 is a bottom plan view thereof;
FIG. 15 is a front top three-dimensional view of the third embodiment of my new design;
FIG. 16 is a rear top three-dimensional view thereof;
FIG. 17 is a front elevation view thereof;
FIG. 18 is a rear elevation view thereof;
FIG. 19 is a right side elevation view thereof;
FIG. 20 is a top plan view thereof;
FIG. 21 is a bottom plan view thereof;
FIG. 22 is a front top three-dimensional view of the fourth embodiment of my new design;
FIG. 23 is a rear top three-dimensional view thereof;
FIG. 24 is a front elevation view thereof;
FIG. 25 is a rear elevation view thereof;
FIG. 26 is a right side elevation view thereof;
FIG. 27 is a top plan view thereof; and
FIG. 28 is a bottom plan view thereof.
The broken lines in the drawings depict portions of a makeup brush handle that forms no part of the claimed design.

1 Claim, 16 Drawing Sheets

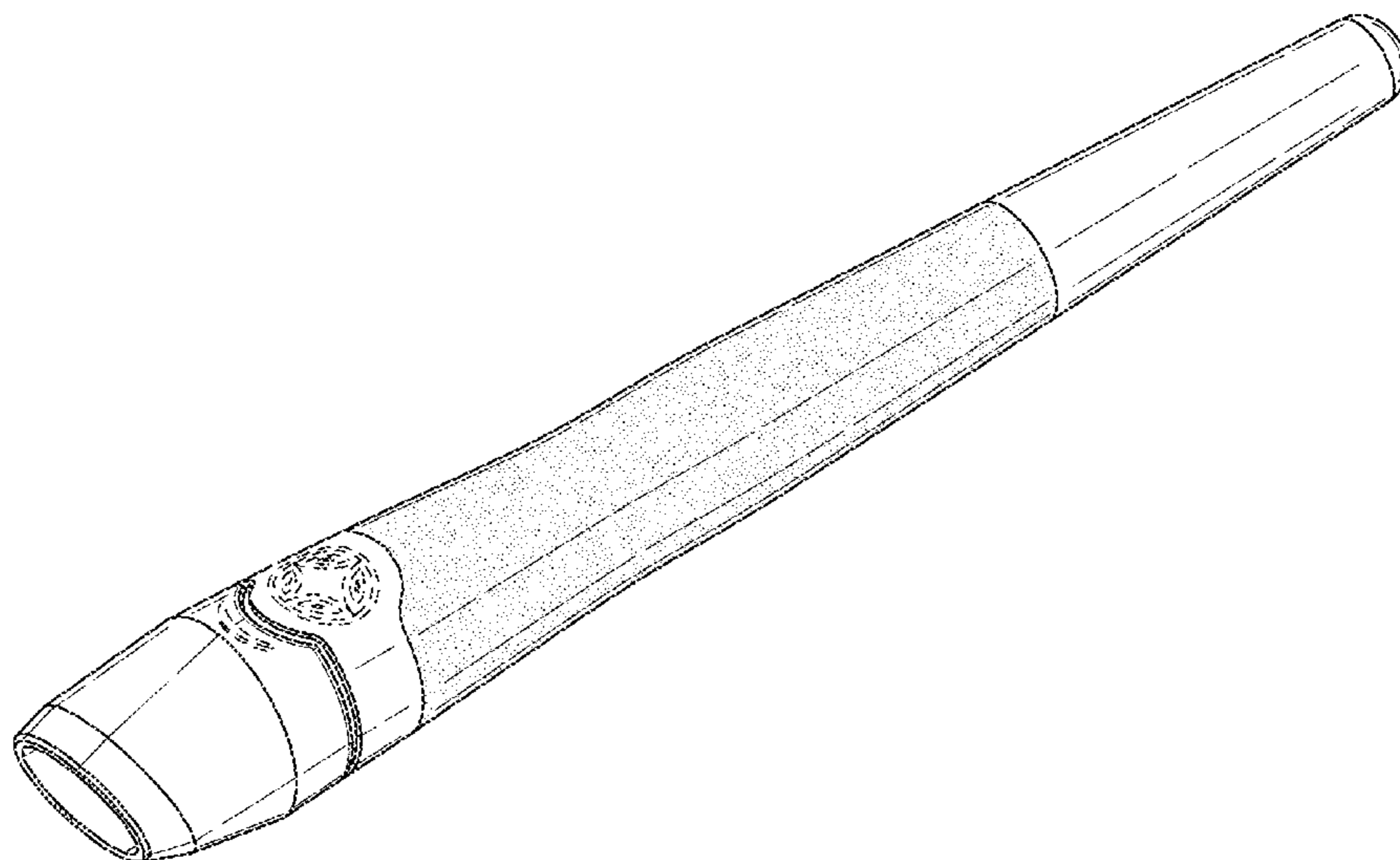

(56)

References Cited

U.S. PATENT DOCUMENTS

D818,719 S * 5/2018 Salm D4/138
D824,177 S * 7/2018 Salm D4/138
D835,419 S * 12/2018 Lim D4/135
D842,547 S * 3/2019 Catolico D28/76
2020/0093247 A1* 3/2020 Guinness A46D 3/047
2021/0120945 A1* 4/2021 Guinness A46D 3/047
2021/0227962 A1* 7/2021 Guinness A46B 5/0095

* cited by examiner

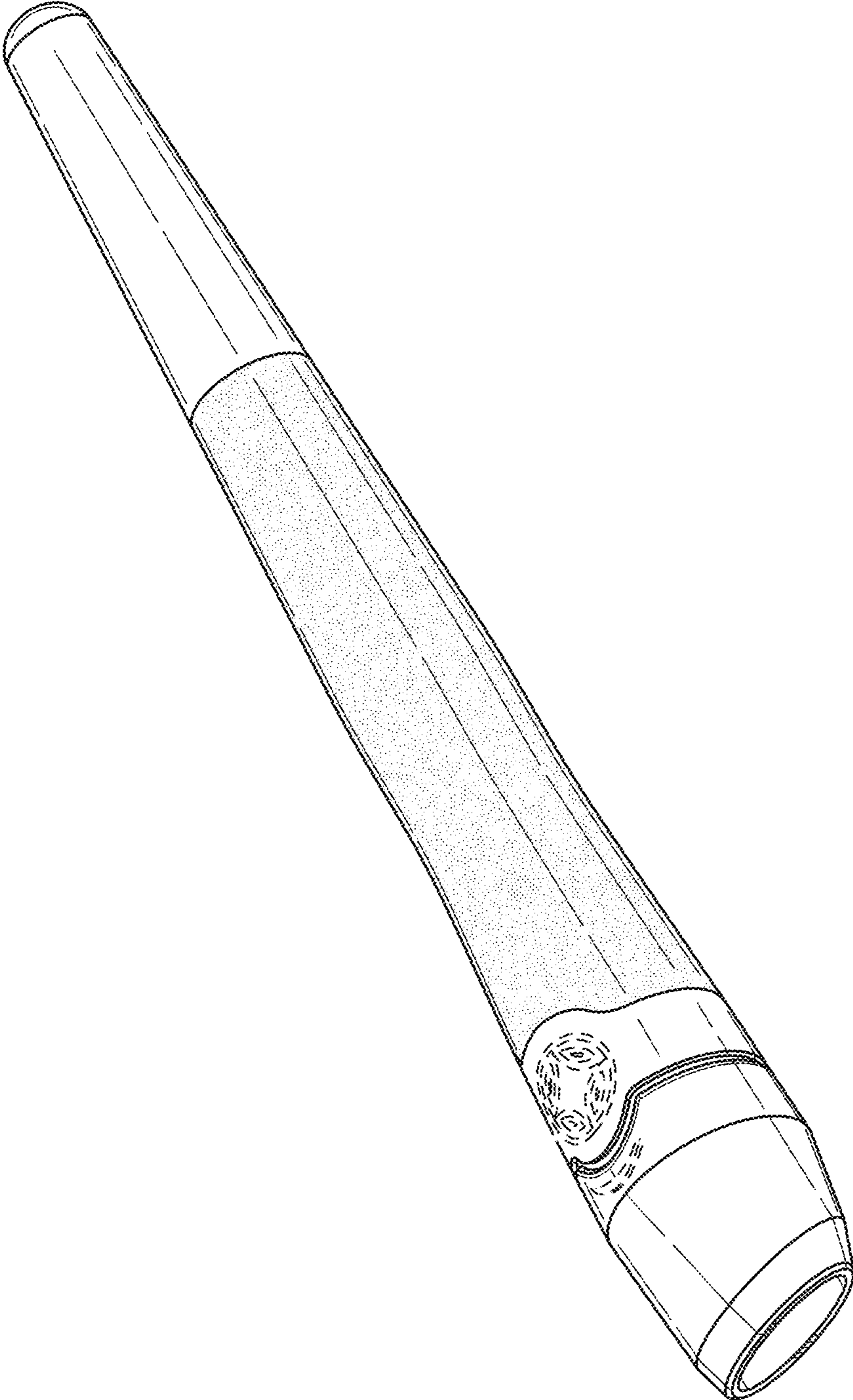

FIG. 1

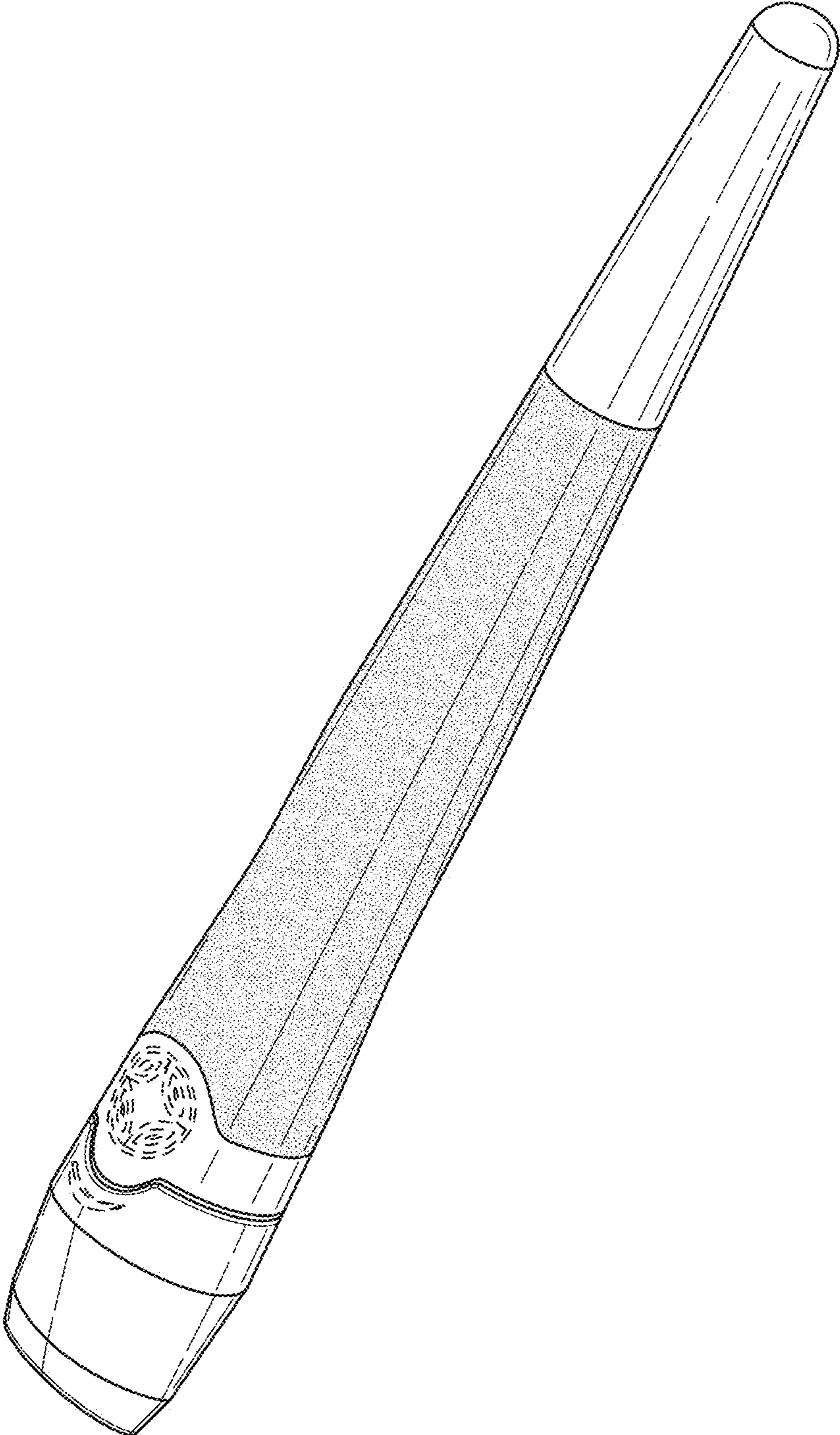

FIG. 2

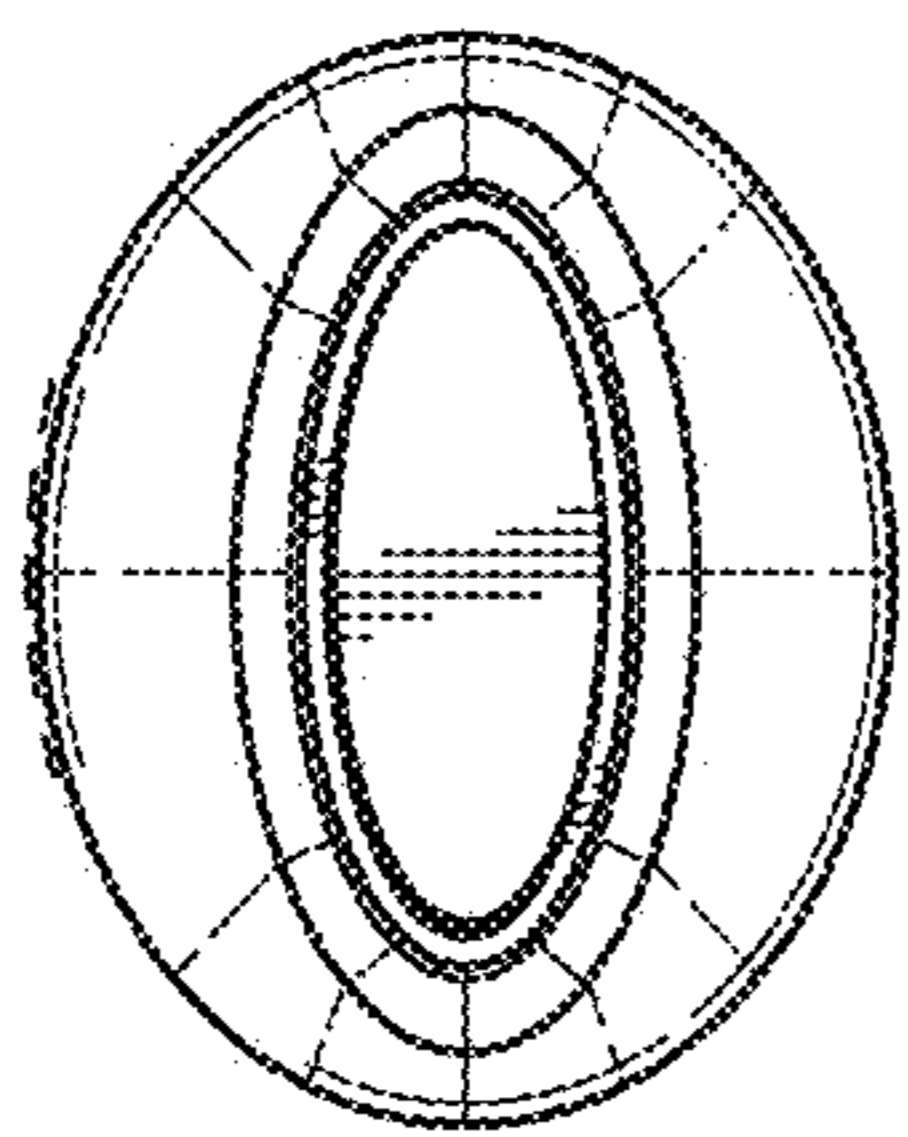

FIG. 3

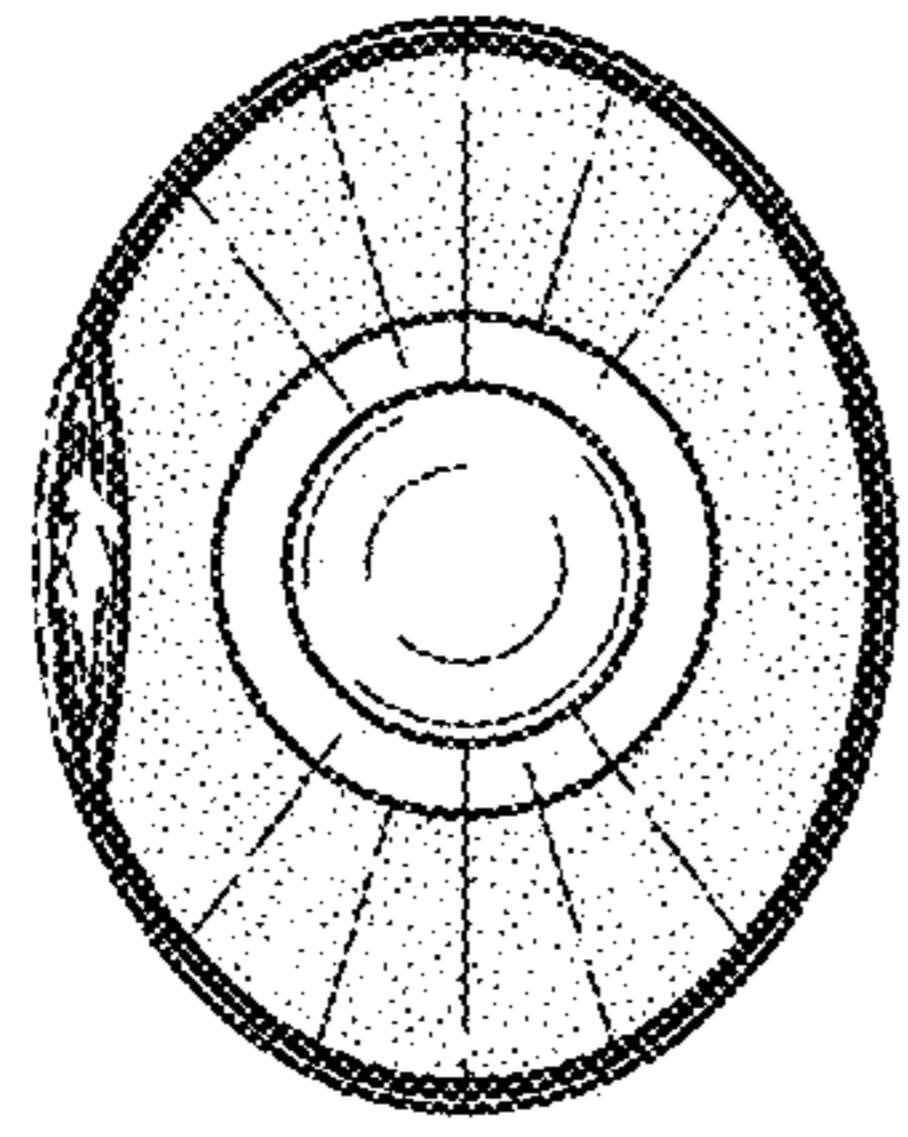

FIG. 4

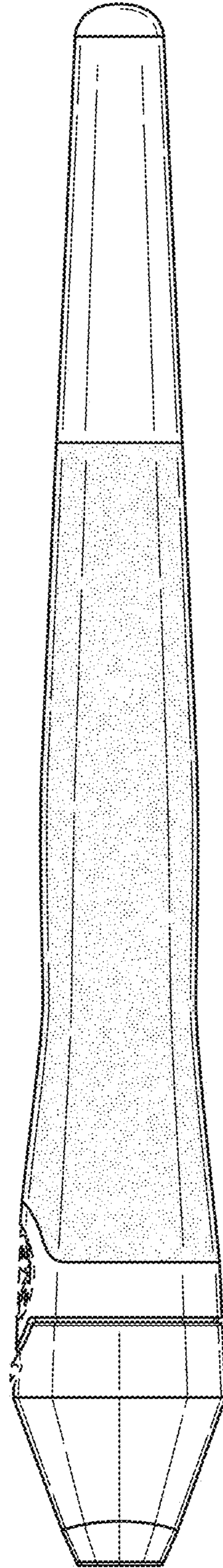

FIG. 5

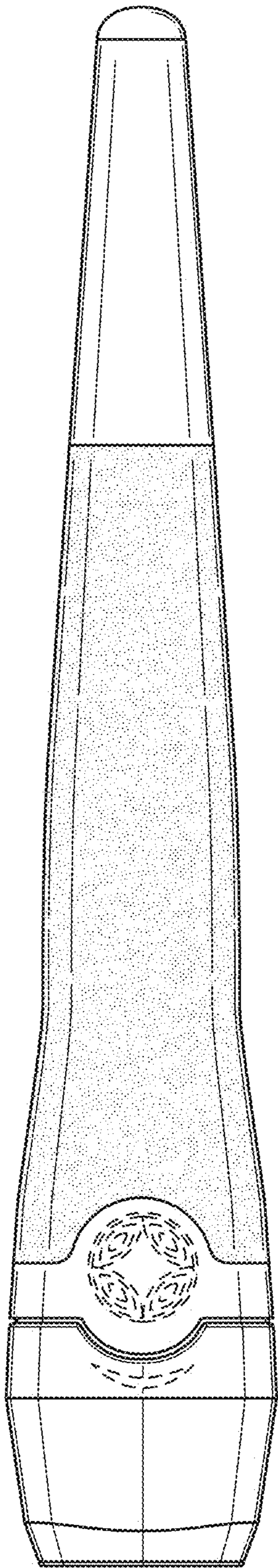

FIG. 6

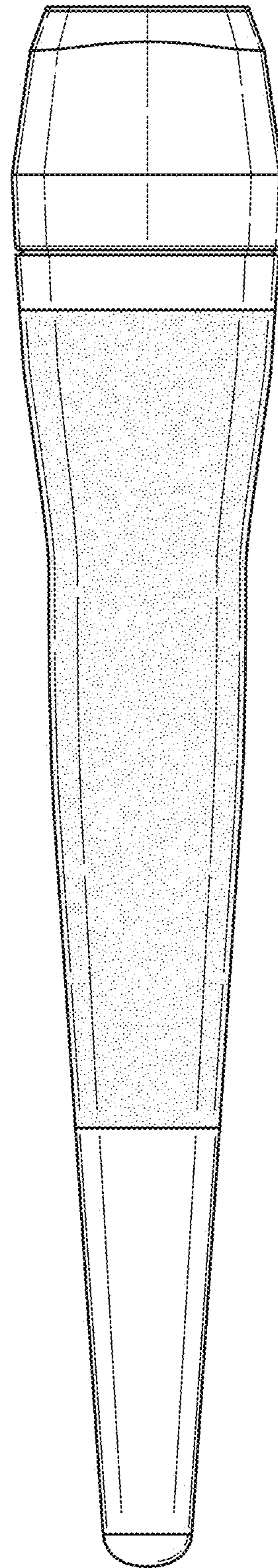

FIG. 7

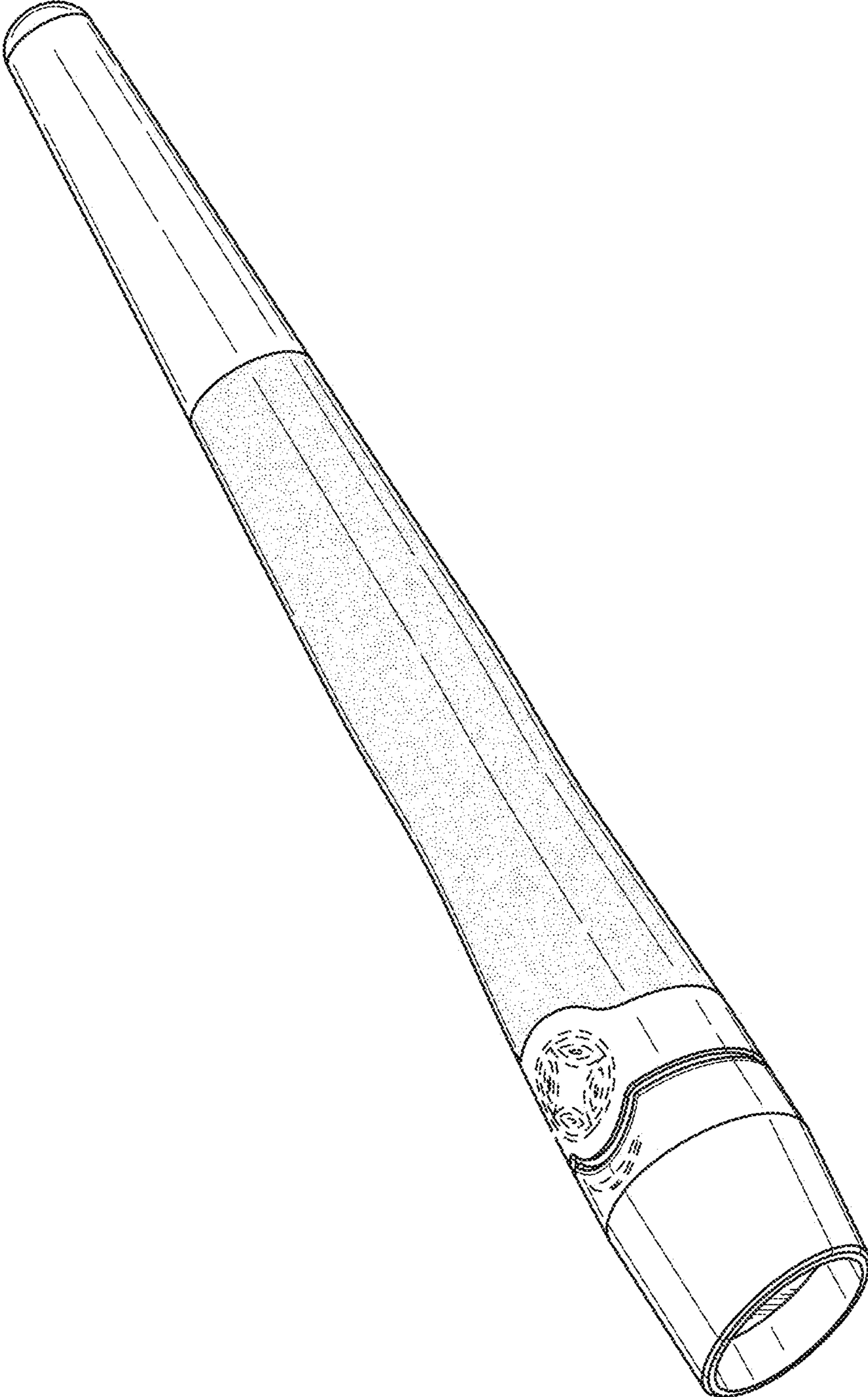

FIG. 8

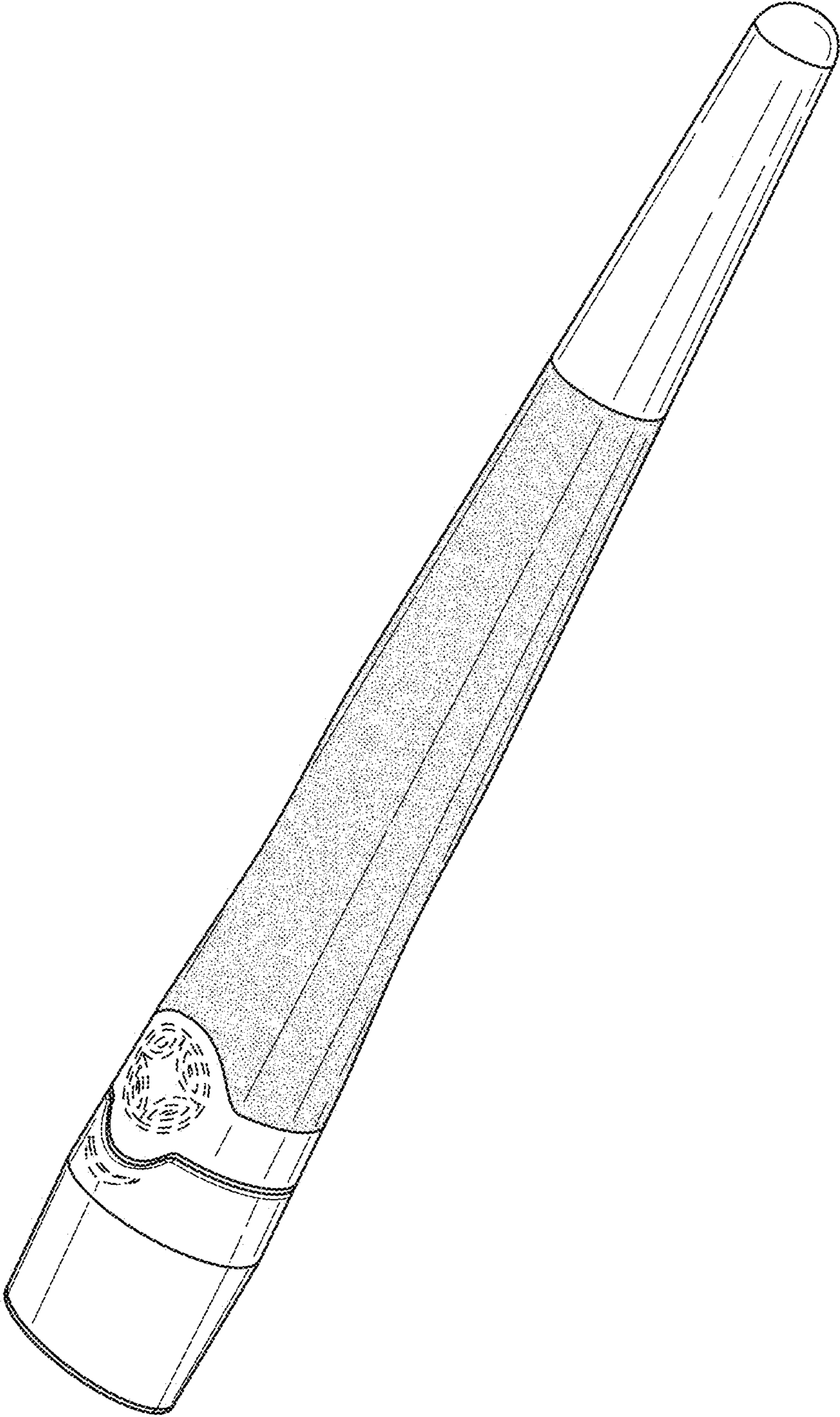

FIG. 9

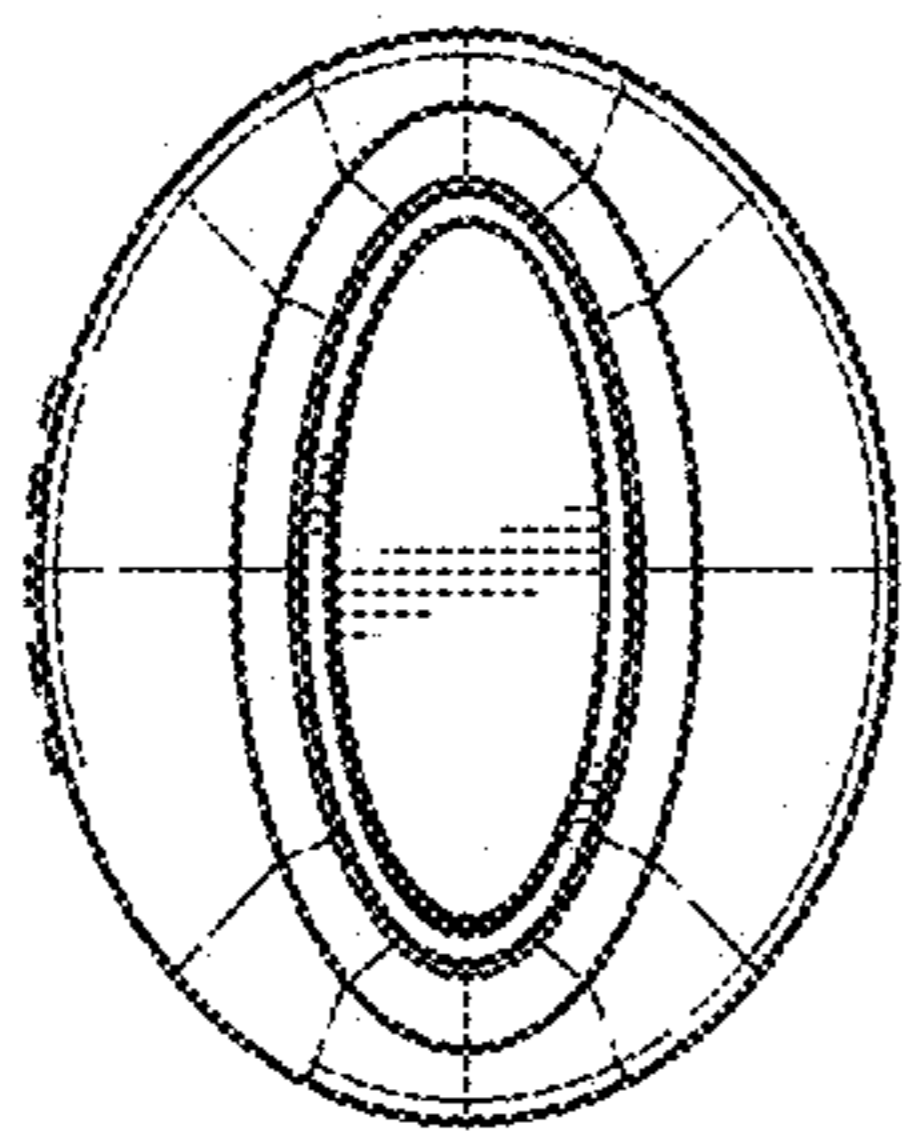

FIG. 10

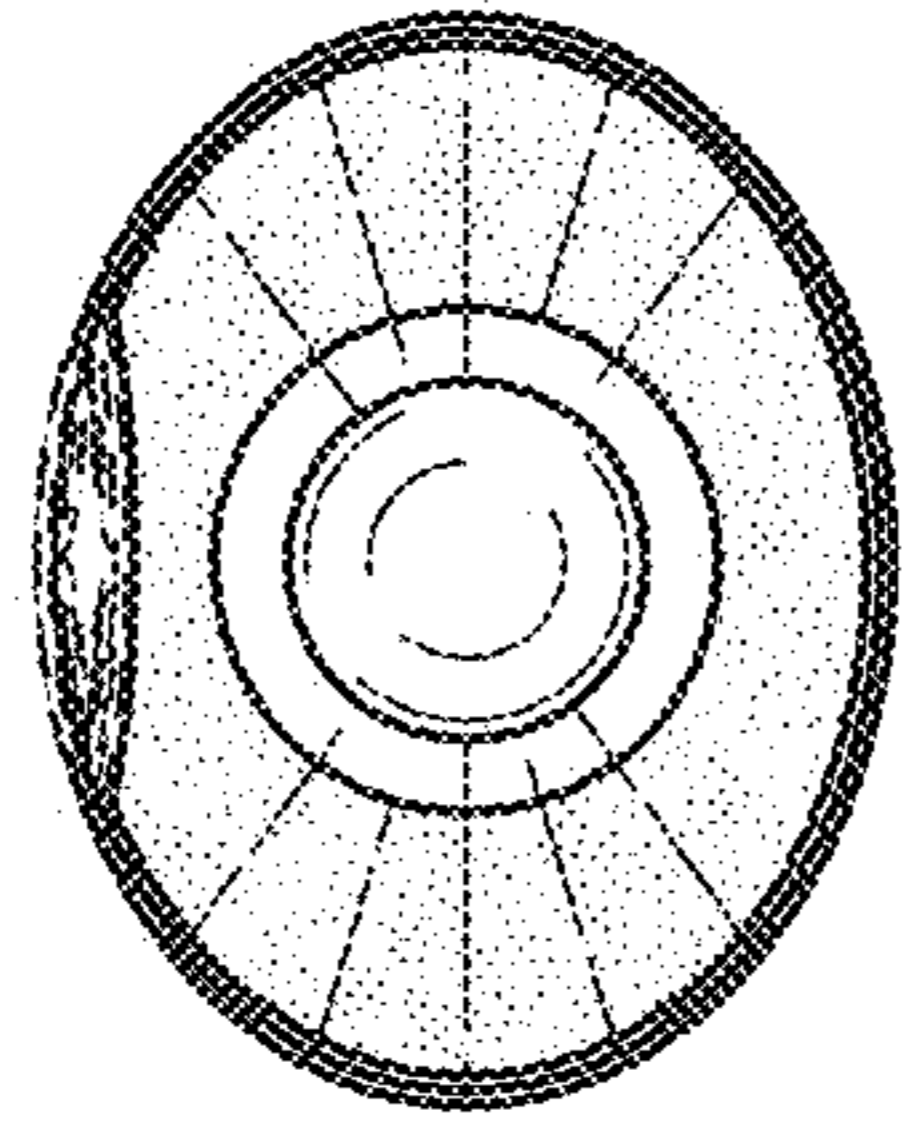

FIG. 11

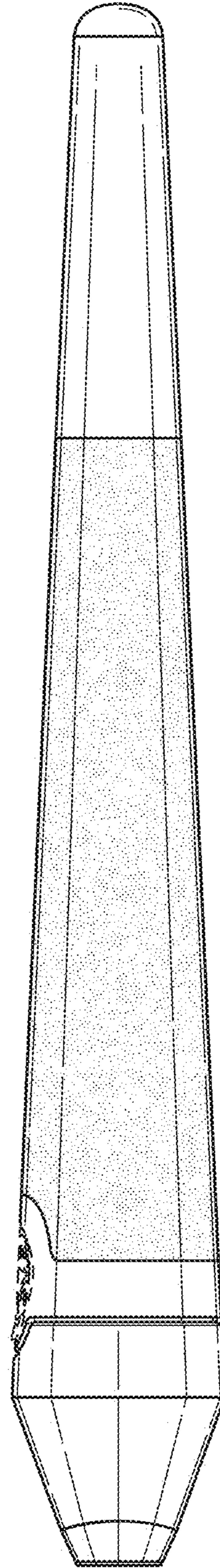

FIG. 12

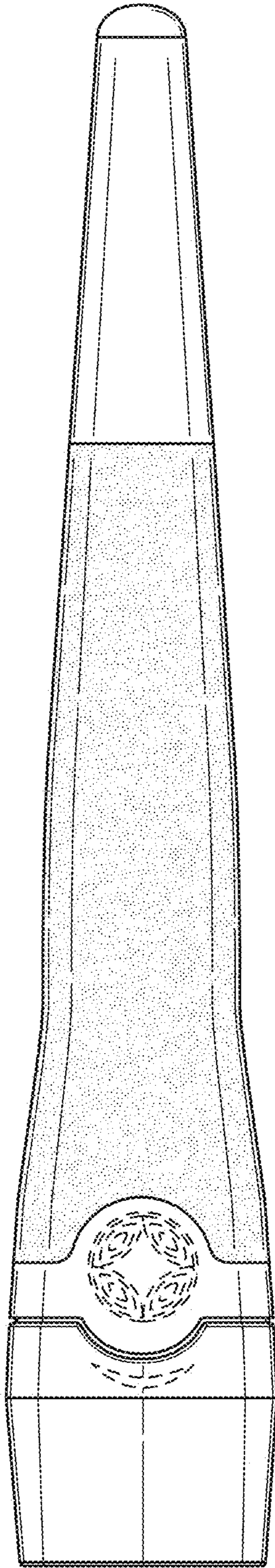

FIG. 13

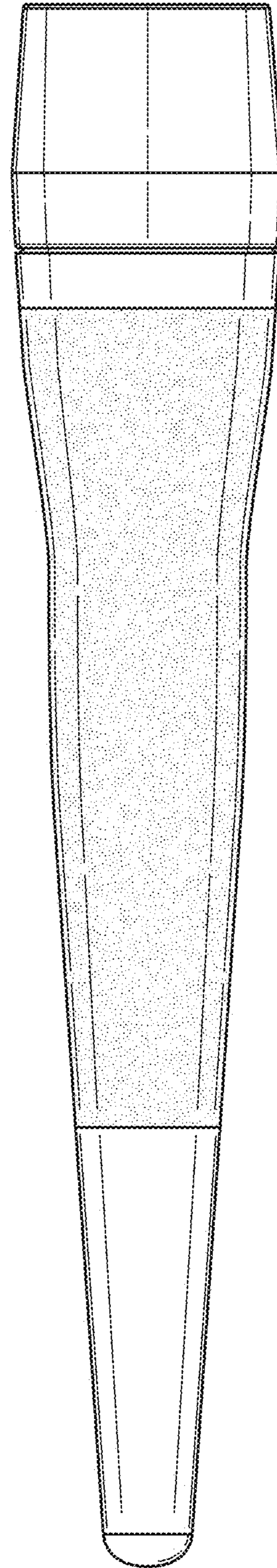

FIG. 14

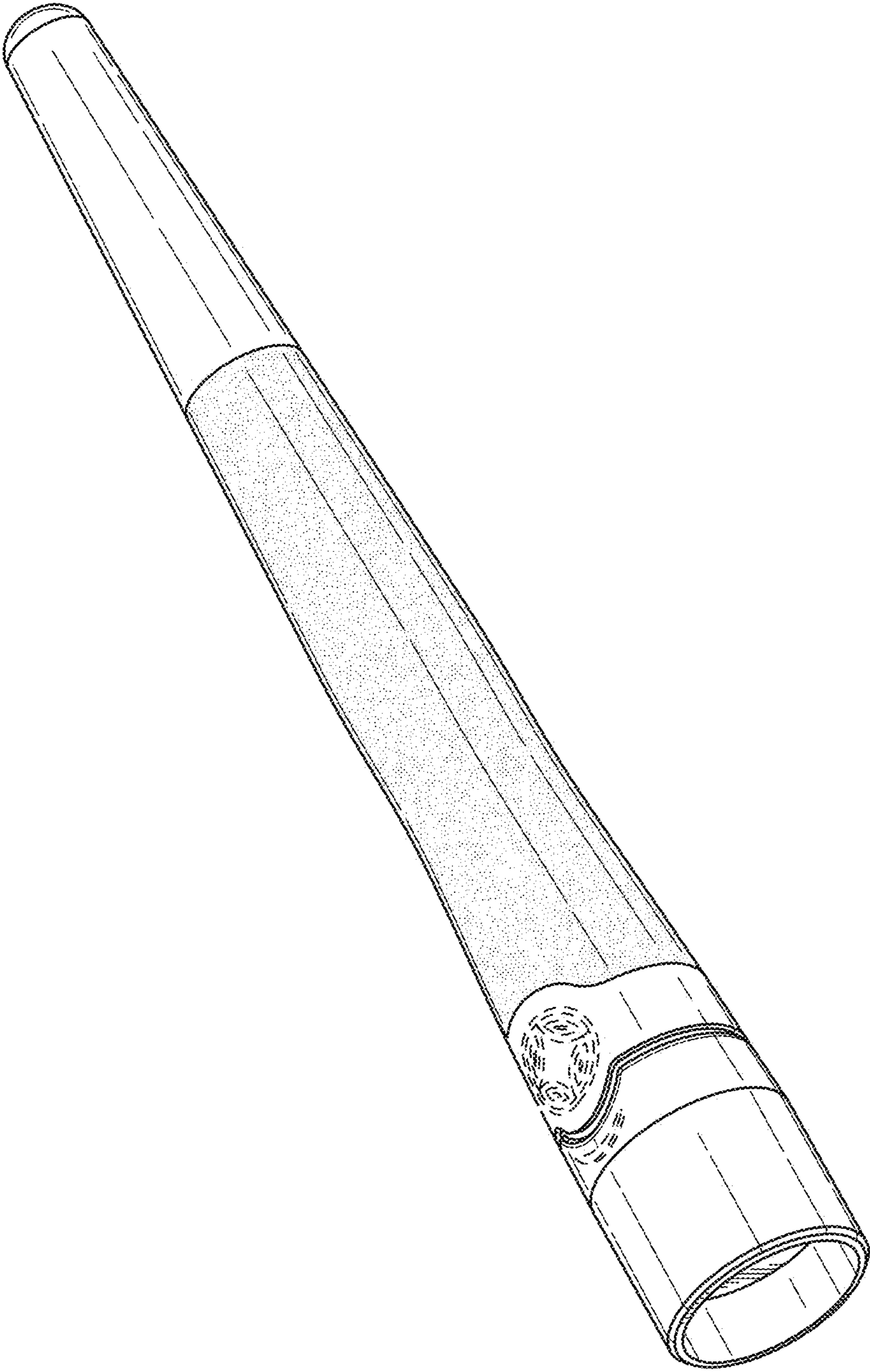

FIG. 15

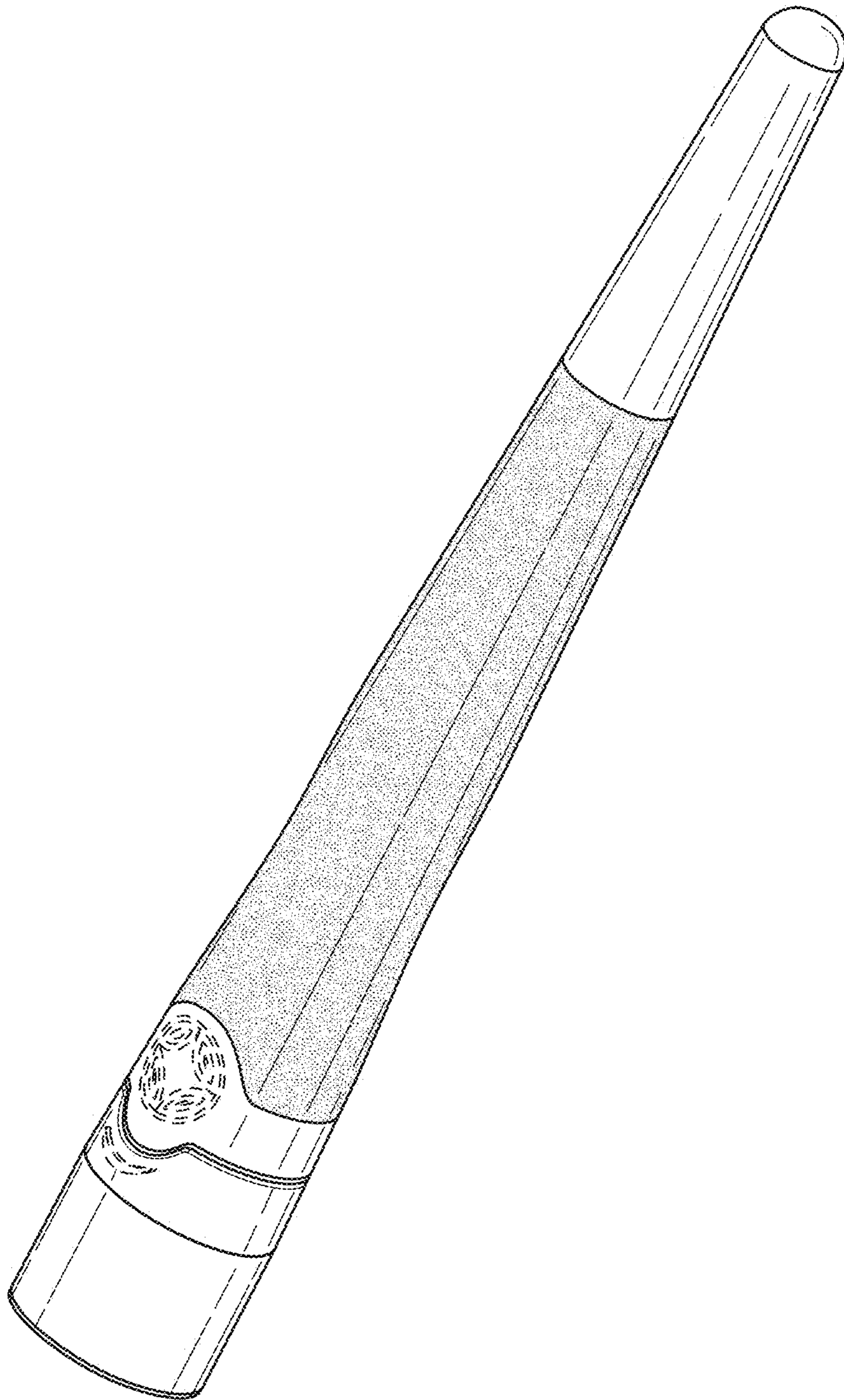

FIG. 16

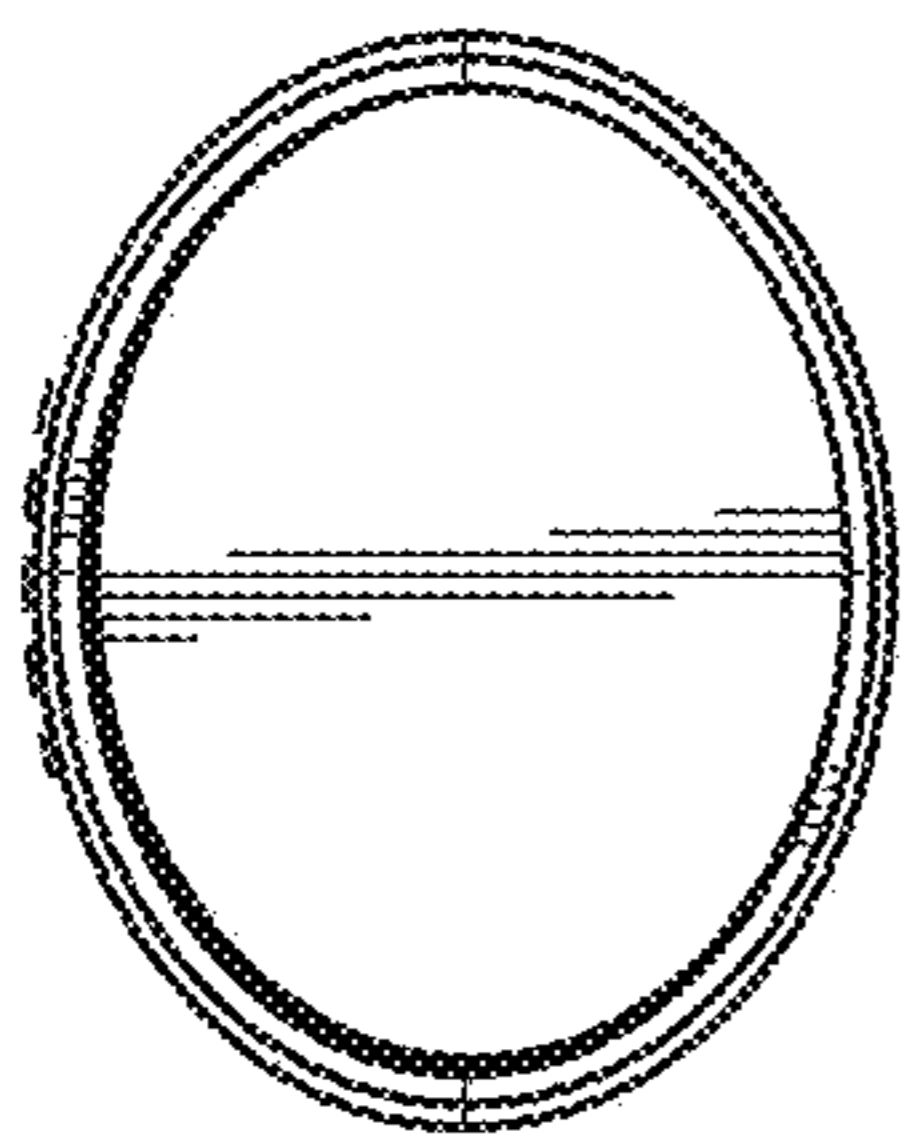

FIG. 17

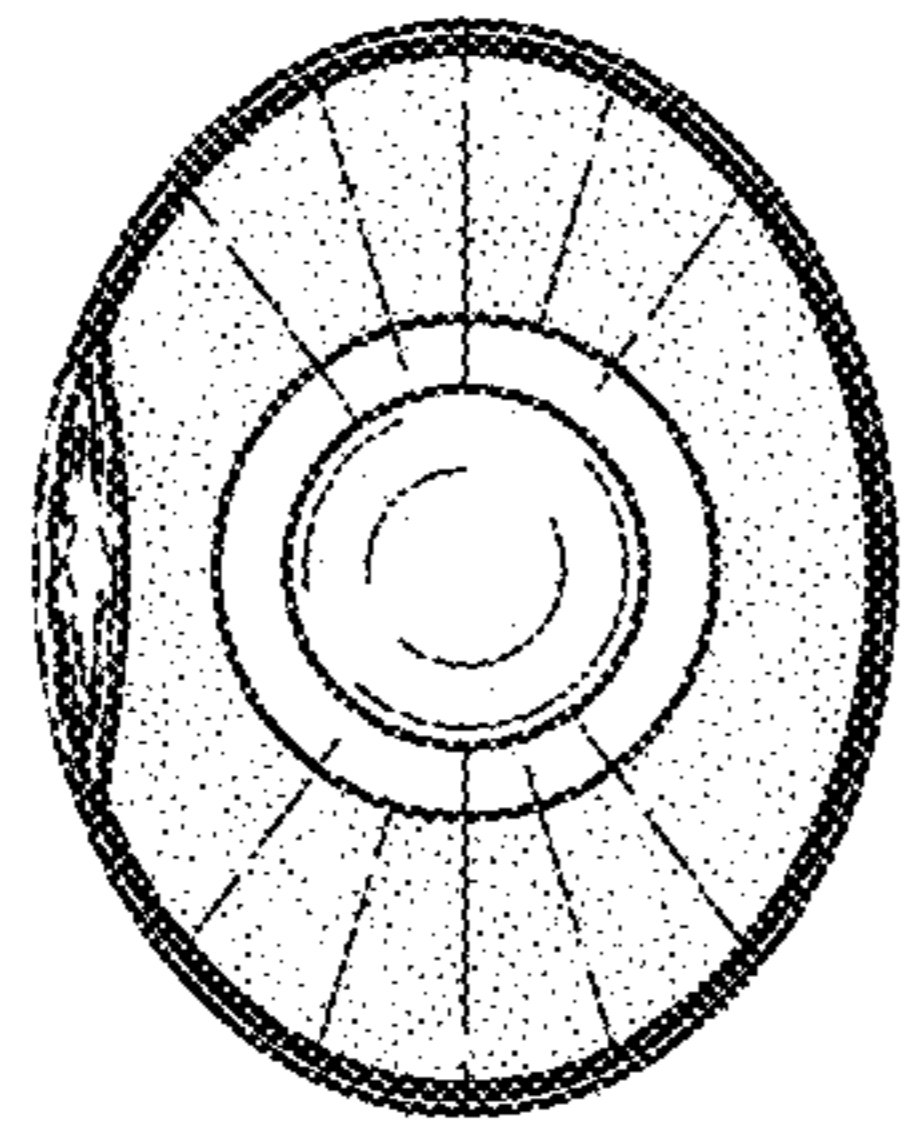

FIG. 18

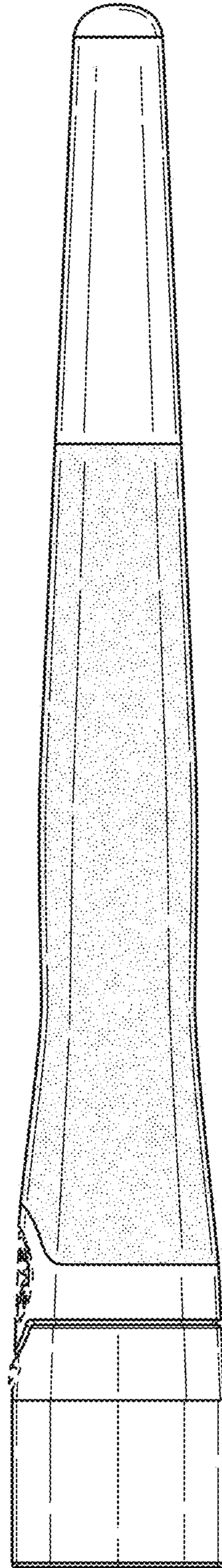

FIG. 19

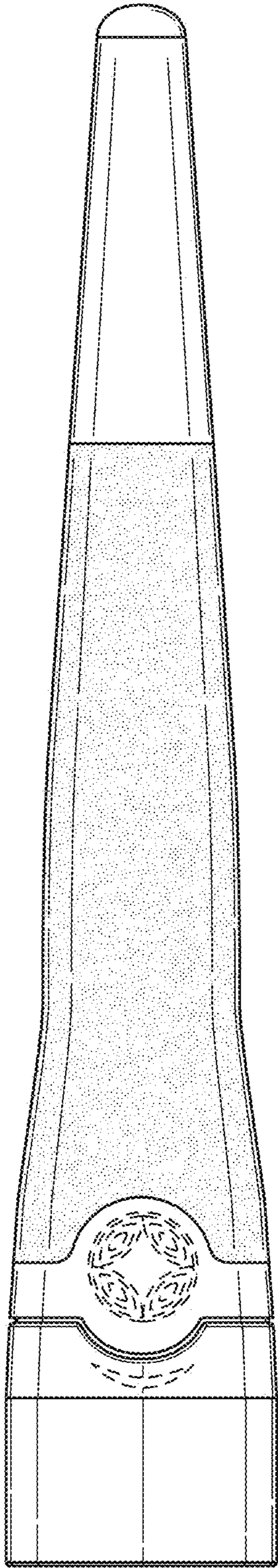

FIG. 20

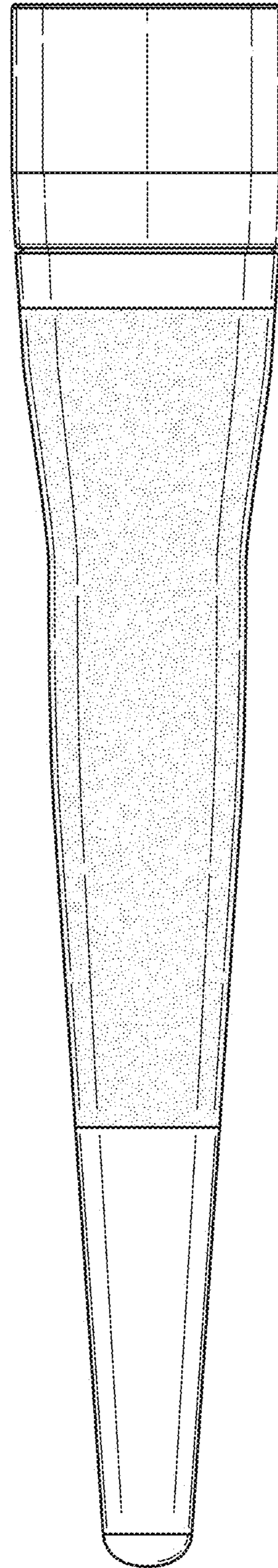

FIG. 21

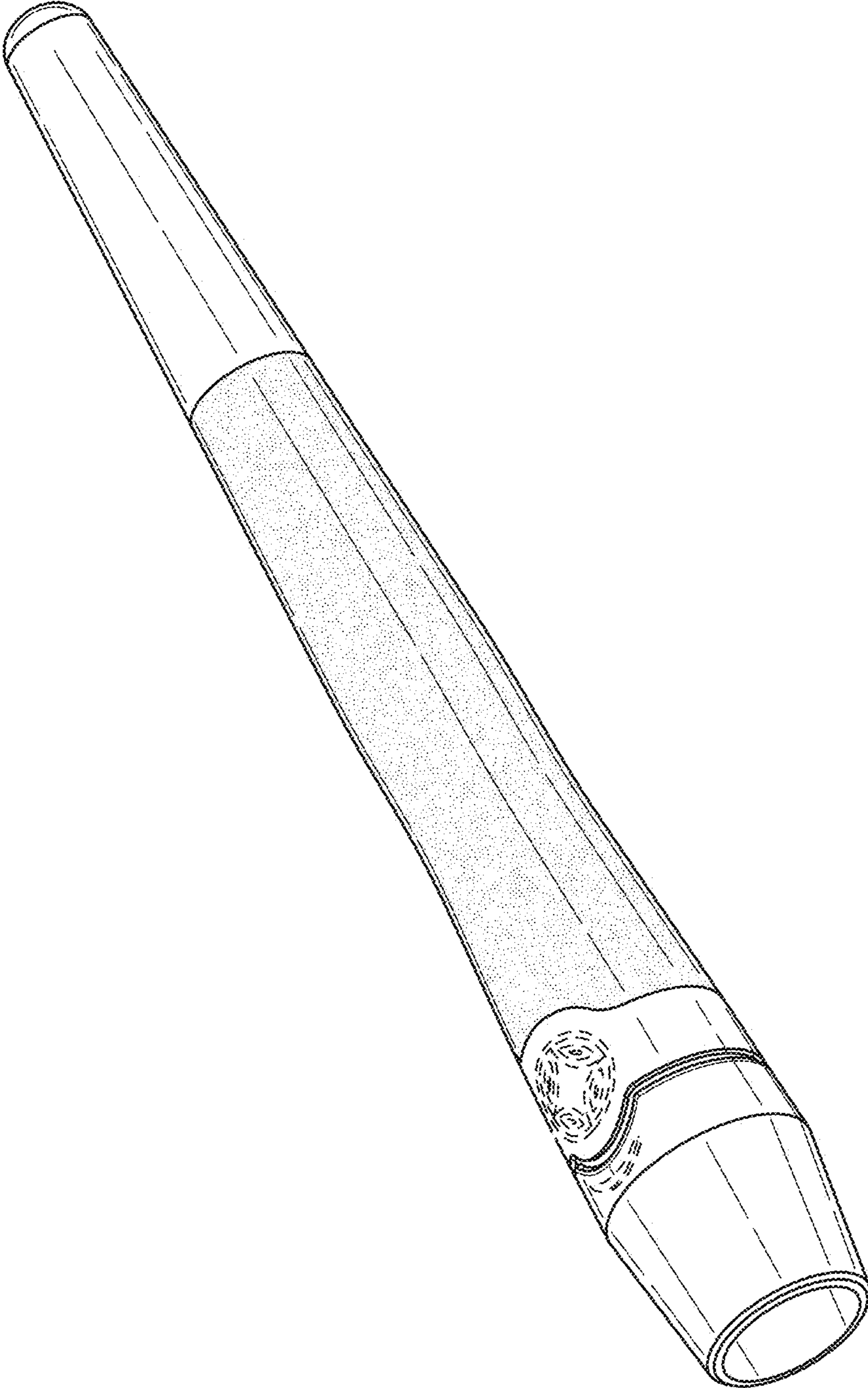

FIG. 22

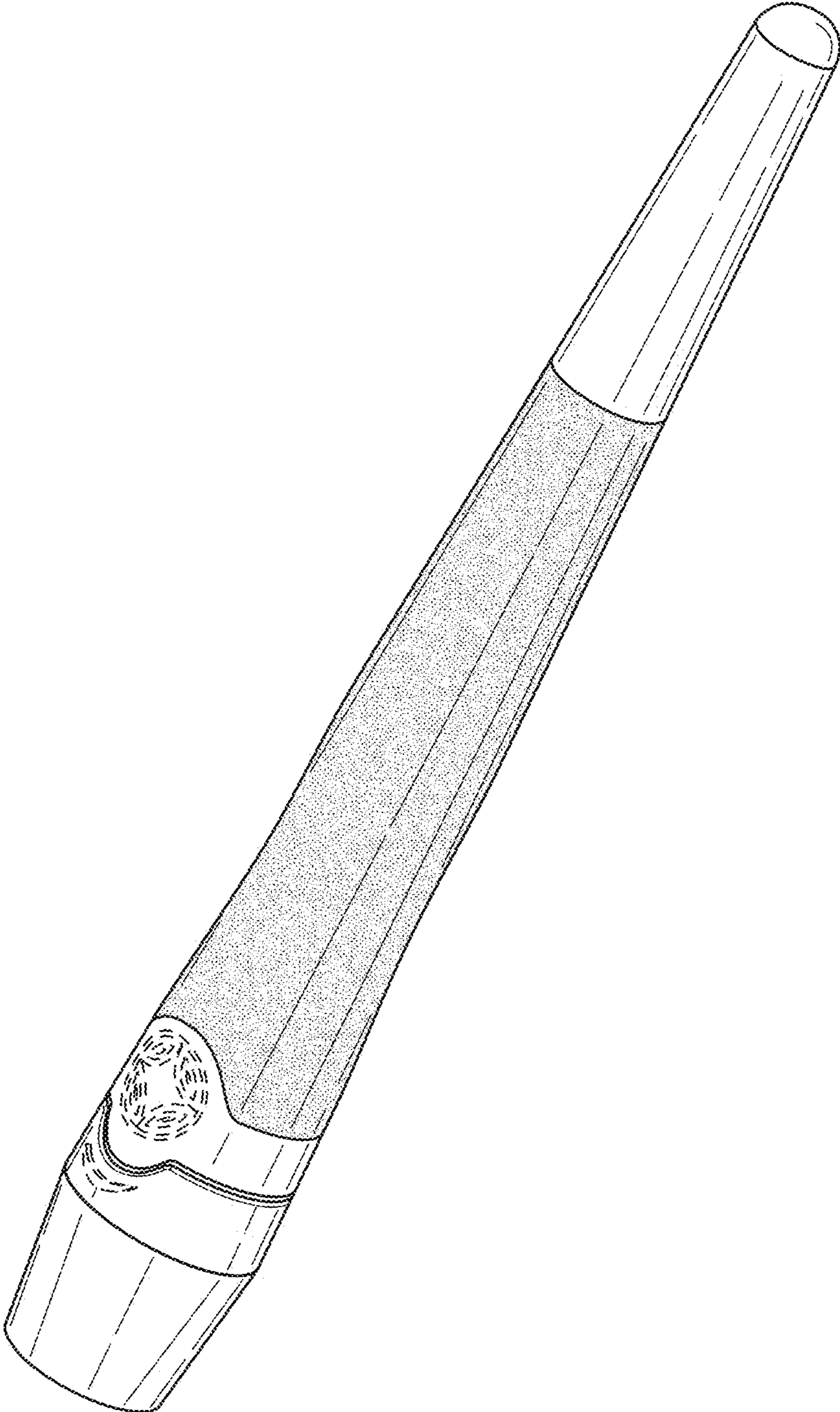

FIG. 23

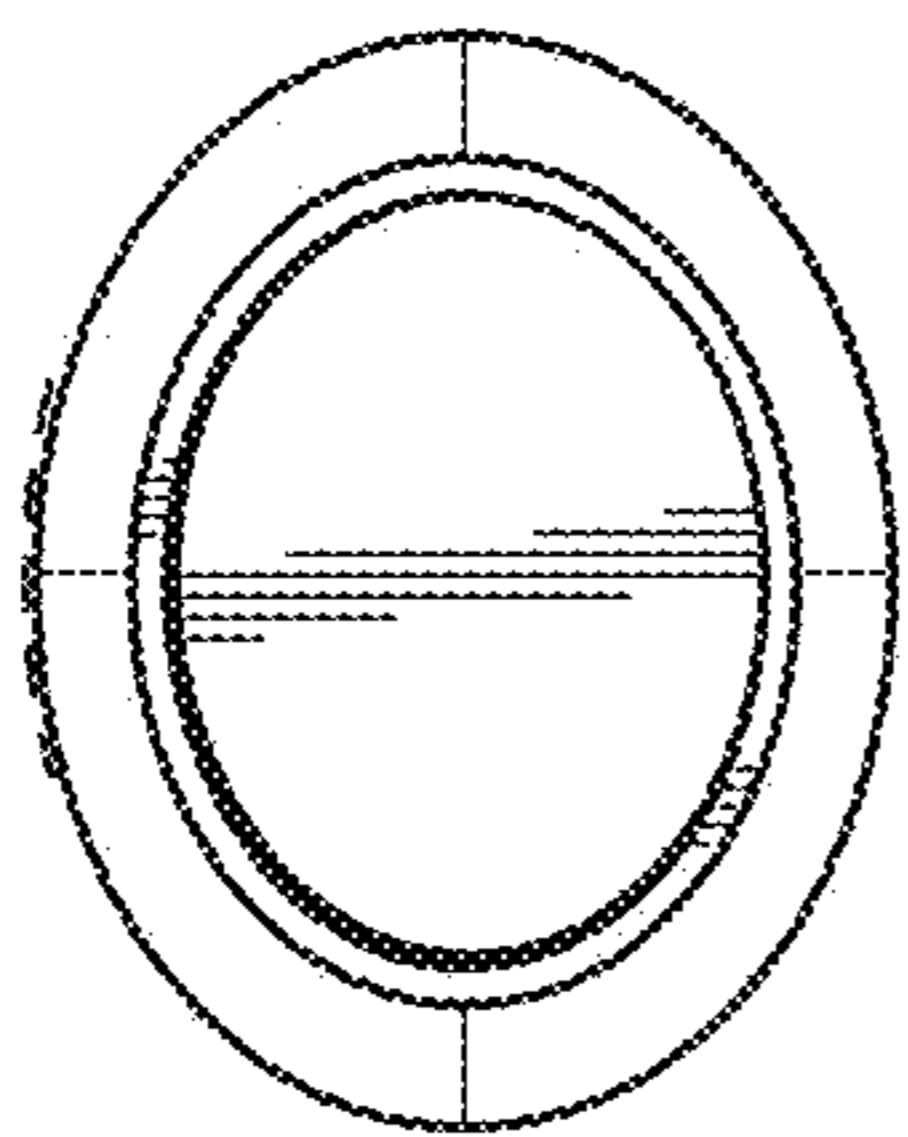

FIG. 24

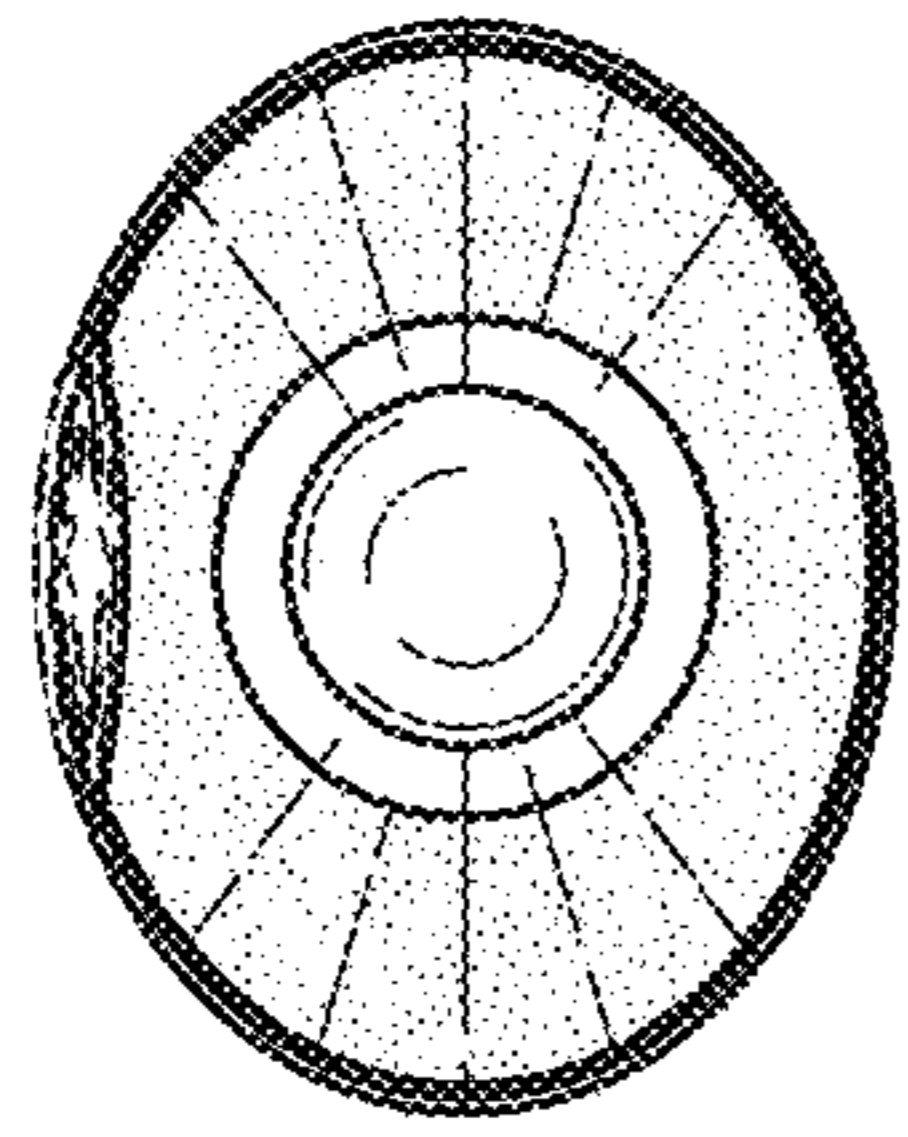

FIG. 25

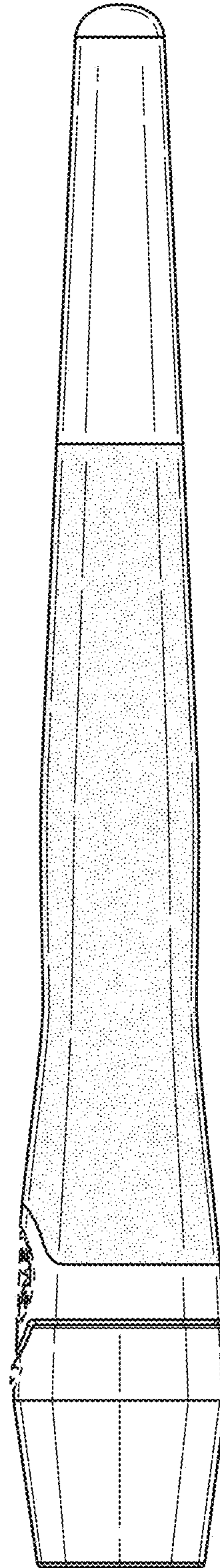

FIG. 26

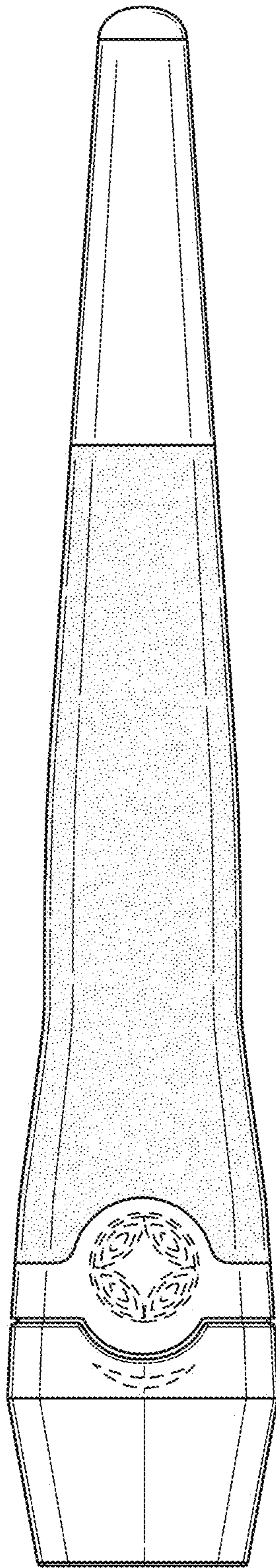

FIG. 27

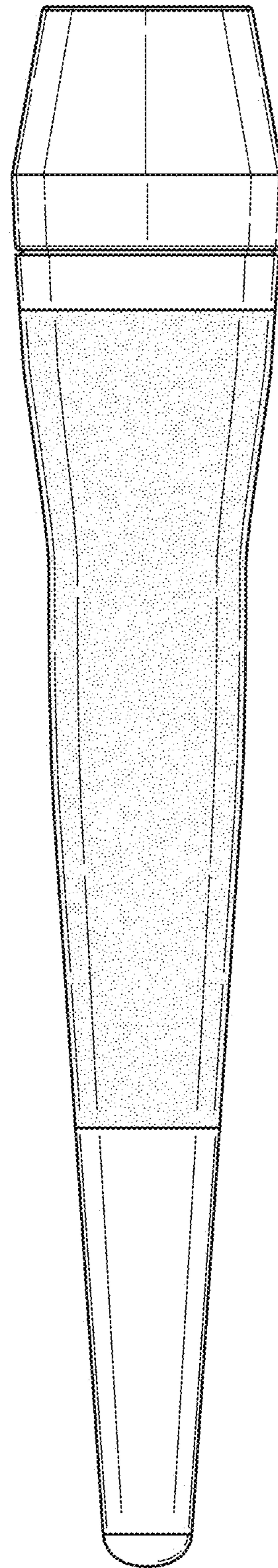

FIG. 28