



US00D963988S

(12) **United States Design Patent** (10) **Patent No.:** **US D963,988 S**  
**Castro, Jr. et al.** (45) **Date of Patent:** **\*\* Sep. 20, 2022**

(54) **GLOVE**

FOREIGN PATENT DOCUMENTS

(71) Applicant: **Performance Fabrics, Inc.**, Grand Rapids, MI (US)

EM 002003426-0001 3/2012

(72) Inventors: **Federico Mauro Castro, Jr.**, Castaic, CA (US); **Danielle E. Bullinger**, Rockford, MI (US)

OTHER PUBLICATIONS

Soldier Systems, OR—Outdoor Research Rockfall Glove, Aug. 6, 2011, 2 pages, Accessed via the Internet at <http://soldiersystems.net/2011/08/06/or-outdoor-research-rockfall-glove/>.

(73) Assignee: **Performance Fabrics, Inc.**, Grand Rapids, MI (US)

(Continued)

(\*\*) Term: **15 Years**

*Primary Examiner* — George D. Kirschbaum

*Assistant Examiner* — Maria J. Edwards

(21) Appl. No.: **29/795,060**

(74) *Attorney, Agent, or Firm* — Price Heneveld LLP

(22) Filed: **Jun. 16, 2021**

(57) **CLAIM**

**Related U.S. Application Data**

We claim the ornamental design for a glove, as shown and described.

(63) Continuation of application No. 29/705,889, filed on Sep. 16, 2019, now Pat. No. Des. 924,538.

(51) **LOC (13) Cl.** ..... **02-06**

**DESCRIPTION**

(52) **U.S. Cl.**

USPC ..... **D2/617**

(58) **Field of Classification Search**

USPC ..... D2/617, 619; D29/113, 117.1, 117.2

CPC ..... A41D 19/00; A41D 19/01505; A41D

19/01547; A41D 19/0048; A41D 2600/20

See application file for complete search history.

FIG. 1 is a front top perspective view of a glove of the present disclosure, shown in an unworn state; FIG. 2 is a top elevational view of the glove of FIG. 1; FIG. 3 is a bottom elevational view of the glove of FIG. 1; FIG. 4 is a first side elevational view of the glove of FIG. 1; FIG. 5 is a second side elevational view of the glove of FIG. 1;

(56) **References Cited**

**U.S. PATENT DOCUMENTS**

2,070,506 A	2/1937	Bevill
D299,564 S	1/1989	Pierce, Jr.
D306,366 S	2/1990	Turpie
D315,620 S	3/1991	Latina
6,367,116 B1	4/2002	DeBartolo
D464,178 S	10/2002	Redwood et al.
D475,175 S	6/2003	Kopala
6,862,744 B2	3/2005	Kuroda et al.
D516,277 S	3/2006	Mattesky

FIG. 6 is a rear elevational view of the glove of FIG. 1; FIG. 7 is a front elevational view of the glove of FIG. 1; FIG. 8 is a front top perspective view of the glove of FIG. 1; shown in a worn state on the hand of a user; and, FIG. 9 is a front bottom perspective view of the glove of FIG. 1, shown in a worn state, on the hand of a user.

The broken line showing of an arm in FIGS. 8 and 9 illustrates environment and forms no part of the claimed design. All other broken lines depict portions of the article and form no part of the claimed design.

(Continued)

**1 Claim, 7 Drawing Sheets**



(56)

References Cited

U.S. PATENT DOCUMENTS

D601,777 S 10/2009 Rolfe  
D608,978 S 2/2010 Votel  
D609,861 S 2/2010 Fitzgerald et al.  
D619,305 S 7/2010 Fitzgerald et al.  
D640,446 S 6/2011 Allen  
D648,490 S 11/2011 Choi et al.  
D650,532 S 12/2011 Choi  
D651,361 S 12/2011 Choi  
D695,968 S 12/2013 Ruminski  
D695,969 S 12/2013 Ruminski  
D703,389 S 4/2014 Ruminski  
D801,625 S 11/2017 Elliott et al.  
D850,010 S 5/2019 Newton et al.  
D924,538 S \* 7/2021 Castro, Jr. .... D2/617  
2006/0212990 A1 9/2006 Mattesky  
2008/0263747 A1 10/2008 DeBlasis et al.

2010/0083420 A1 4/2010 Bouckaert  
2011/0088139 A1 4/2011 Travell  
2021/0378332 A1\* 12/2021 Tryner ..... A41D 19/0048

OTHER PUBLICATIONS

Columbia Wind Bloc Gloves, posted at amazon.com, posting date Aug. 8, 2014, [online], [site visited Feb. 24, 2021]. Available from Internet, URL: <https://www.amazon.com/Columbia-Sportswear-Mens-Wind-Gloves/dp/B00MVIBPL2> (Year: 2014).  
Isotoner Smartouch Fleece Gloves, posted at kohls.com, posting date not given, [online], [site visited Feb. 24, 2021]. Available from Internet, URL: <https://www.kohls.com/product/prd-1790772/isotoner-smartouch-fleece-gloves-women.jsp> (Year: 2021).  
Sportful Fiandre Light Gloves, posted at road.cc, posting date Mar. 7, 2020, [online], [site visited Feb. 24, 2021]. Available from Internet, URL: <https://road.cc/content/review/271781-sportful-fiandre-light-gloves> (Year: 2021).

\* cited by examiner



FIG. 1

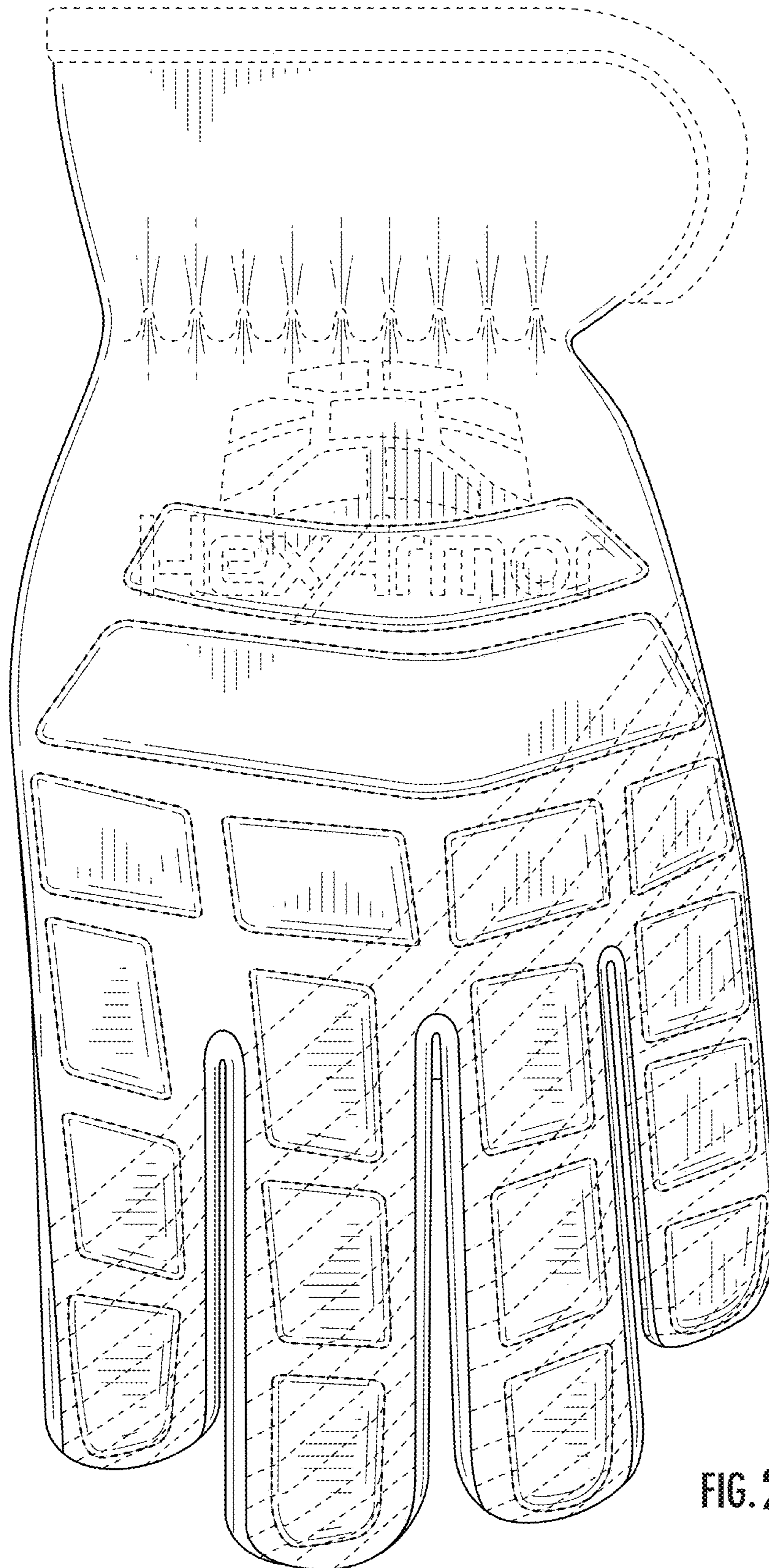

FIG. 2

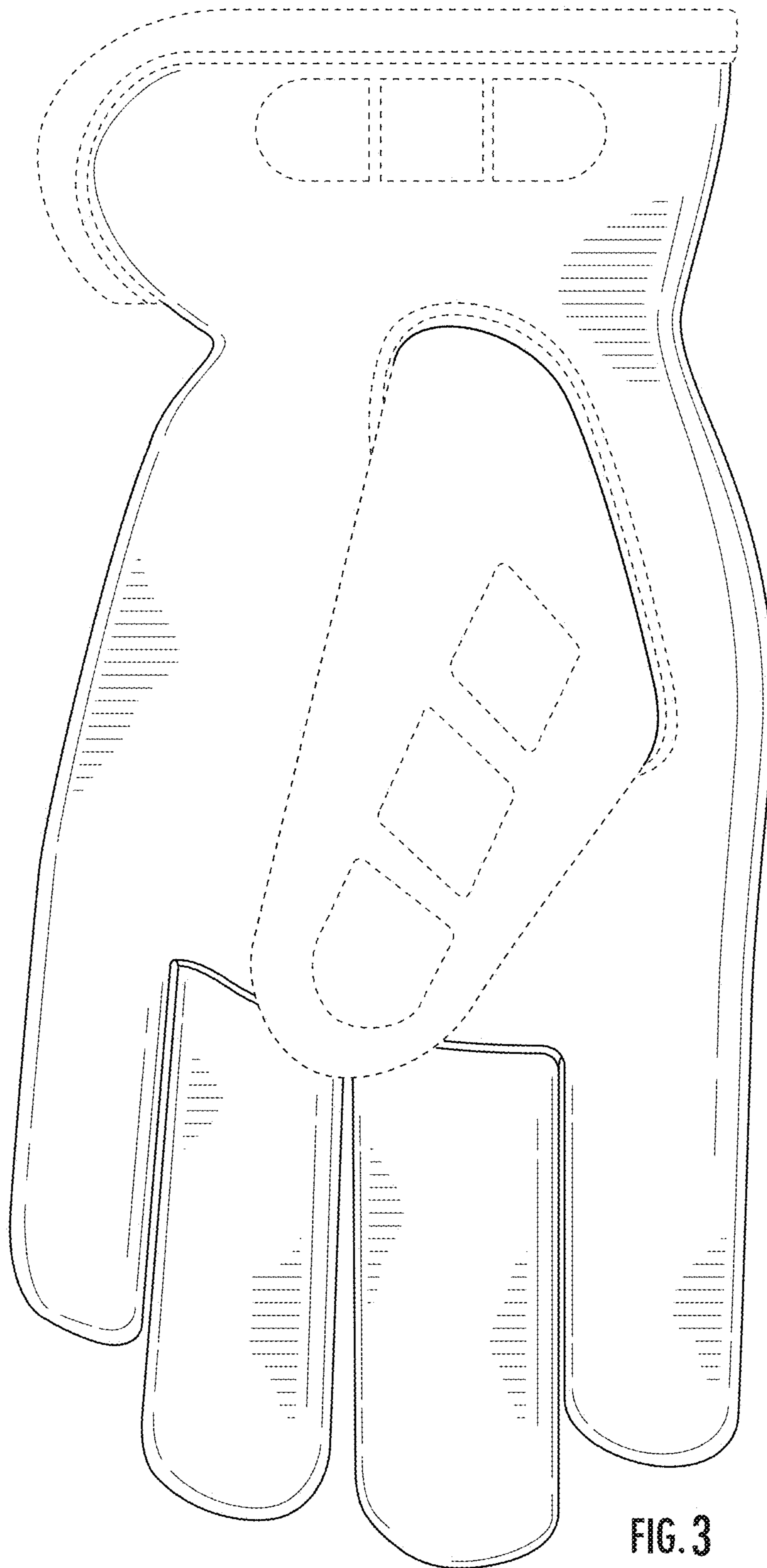

FIG. 3

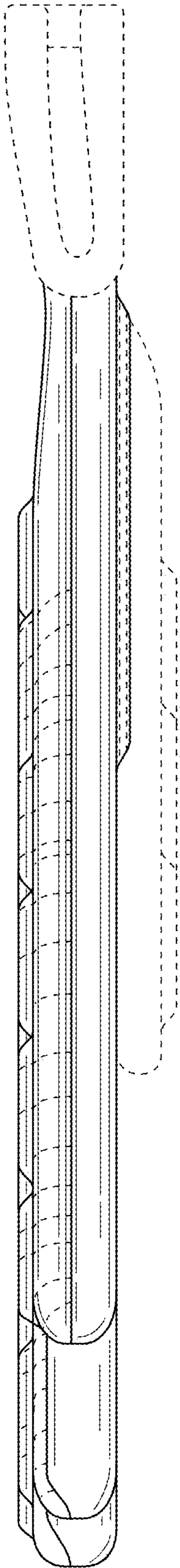

FIG. 4

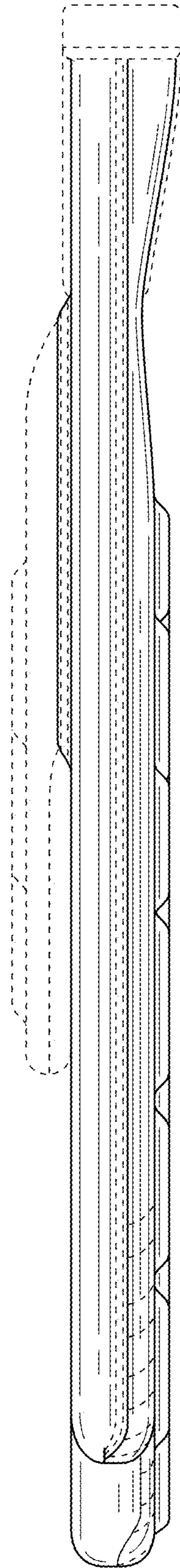

FIG. 5

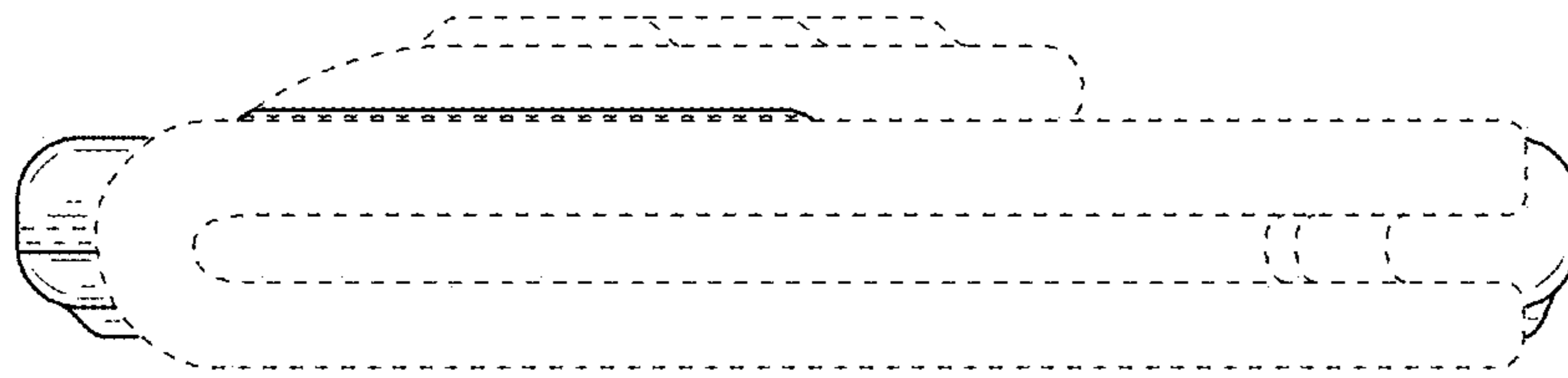

FIG. 6

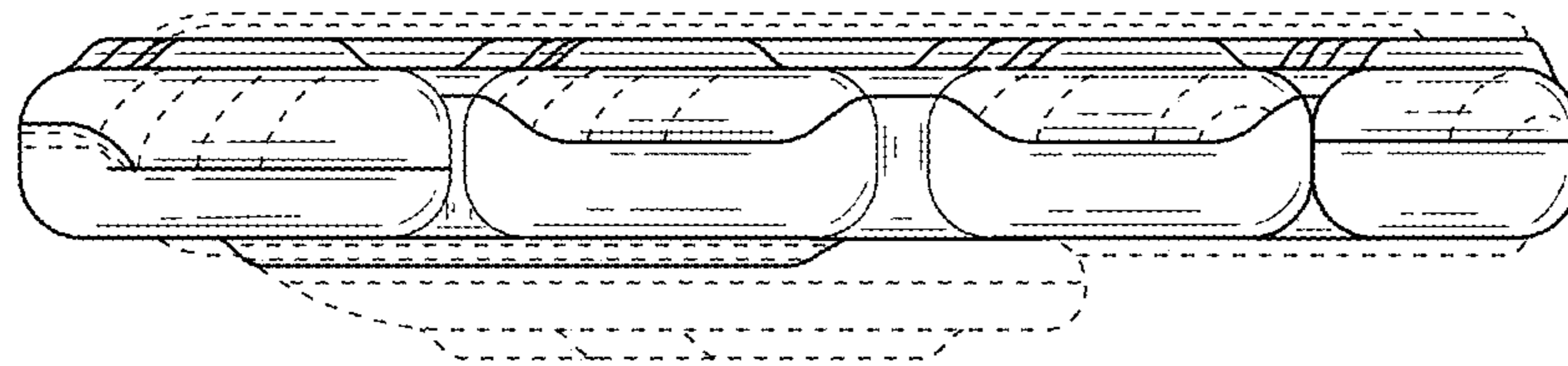

FIG. 7

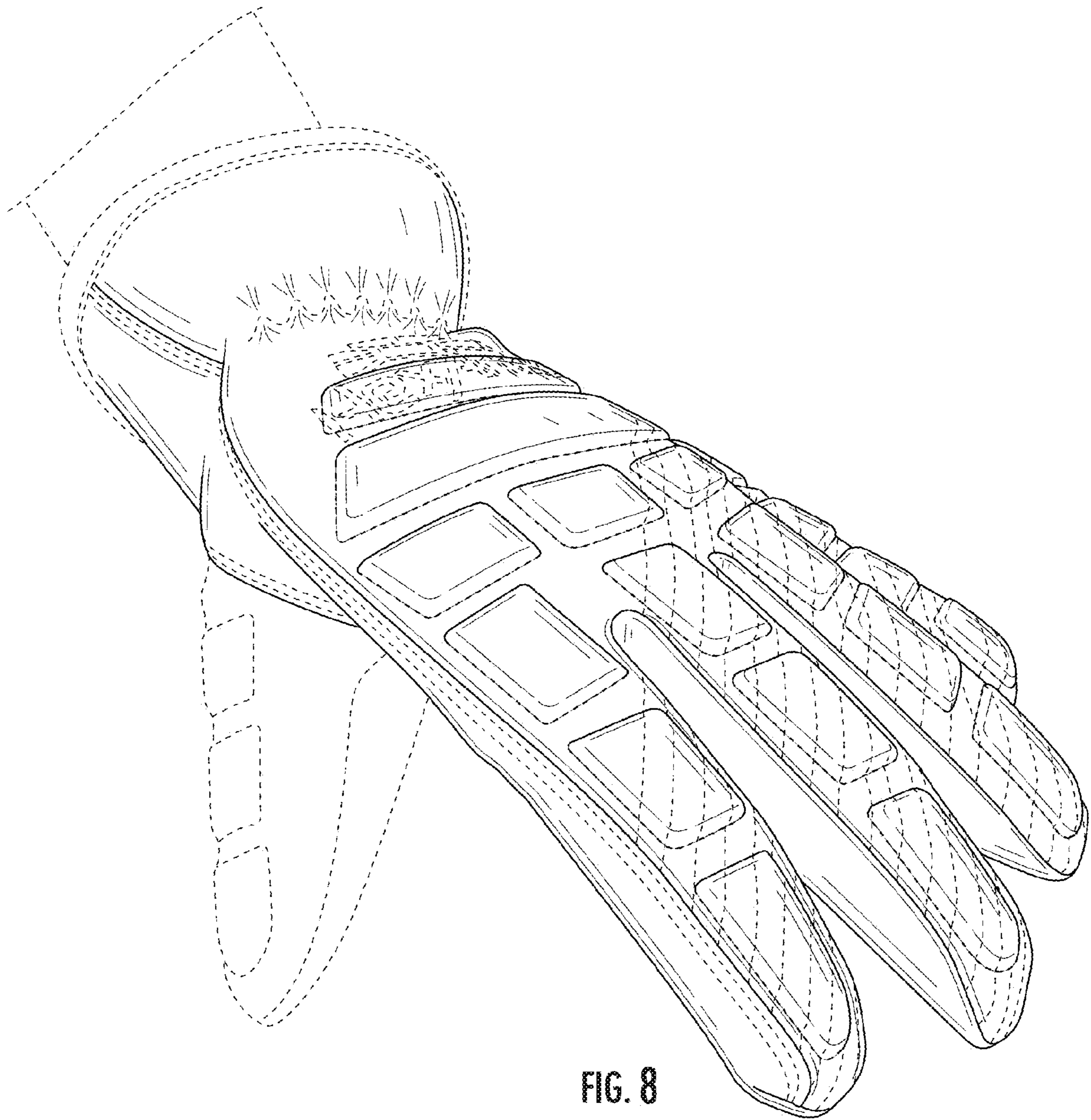

FIG. 8



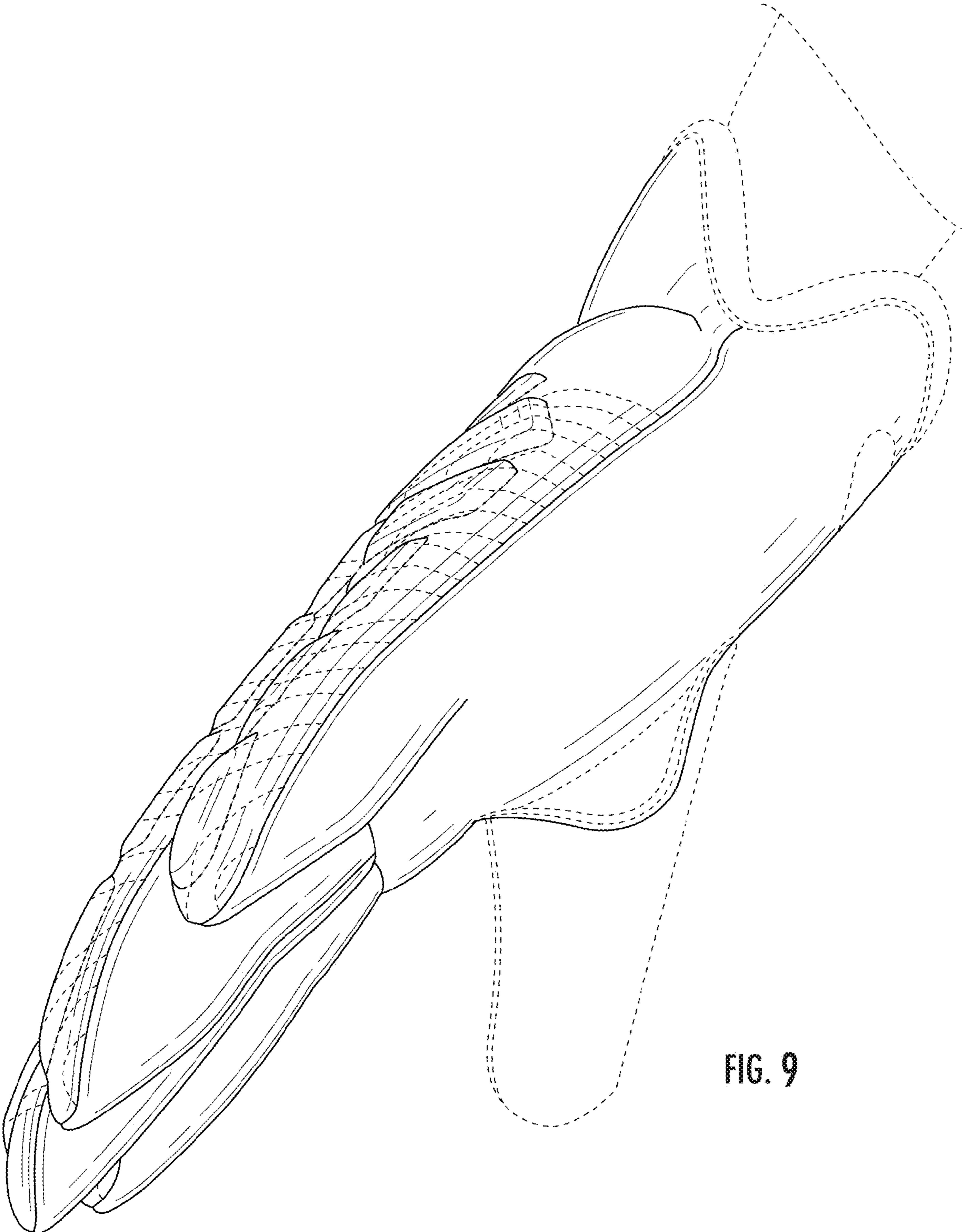

FIG. 9