



US00D963906S

(12) **United States Design Patent** (10) **Patent No.:** **US D963,906 S**
Chen (45) **Date of Patent:** **** Sep. 13, 2022**

(54) **HEADLIGHT**

(56) **References Cited**

(71) Applicant: **Zhejiang Yuanzheng Auto & Motorcycle accessories Ltd, Ruian (CN)**

U.S. PATENT DOCUMENTS

D874,031 S *	1/2020	Herzog	D26/28
D906,556 S *	12/2020	Yang	D26/28
D917,745 S *	4/2021	Wu	D26/28
D920,545 S *	5/2021	Mack	D26/28
D930,858 S *	9/2021	Yang	D26/28

(72) Inventor: **Yu Chen, Ruian (CN)**

* cited by examiner

(73) Assignee: **ZHEJIANG YUANZHENG AUTO & MOTORCYCLE ACCESSORIES LTD., Ruian (CN)**

Primary Examiner — Leanne Was-Englehart

(**) Term: **15 Years**

(74) *Attorney, Agent, or Firm* — Bayramoglu Law Offices LLC

(21) Appl. No.: **29/740,866**

(57) **CLAIM**

(22) Filed: **Jul. 8, 2020**

The ornamental design for a headlight, as shown and described.

(30) **Foreign Application Priority Data**

DESCRIPTION

May 12, 2020 (CN) 202030212068.2

(51) **LOC (13) Cl.** **26-06**

(52) **U.S. Cl.**
USPC **D26/28**

(58) **Field of Classification Search**
USPC D26/28, 29, 30, 31, 32, 33, 34, 35, 36
CPC F21S 41/00; F21S 41/141; F21S 41/162;
F21S 41/18; F21S 41/20; F21S 41/36;
F21S 41/60; F21W 2103/40; F21W 2103/35; F21W 2107/17; F21W 2107/13;
F21W 2102/17; F21W 2102/30; F21W 2103/00; F21W 2103/55; F21W 2104/00

FIG. 1 is a front, right and bottom perspective view of a headlight showing my new design;
FIG. 2 is a front view thereof;
FIG. 3 is a rear view thereof;
FIG. 4 is a right side view thereof;
FIG. 5 is a left side view thereof;
FIG. 6 is a bottom view thereof;
FIG. 7 is a top view thereof; and,
FIG. 8 is a rear, left and top perspective view thereof.
The broken lines in the drawings depict portions of the headlight that form no part of the claimed design.

See application file for complete search history.

1 Claim, 8 Drawing Sheets

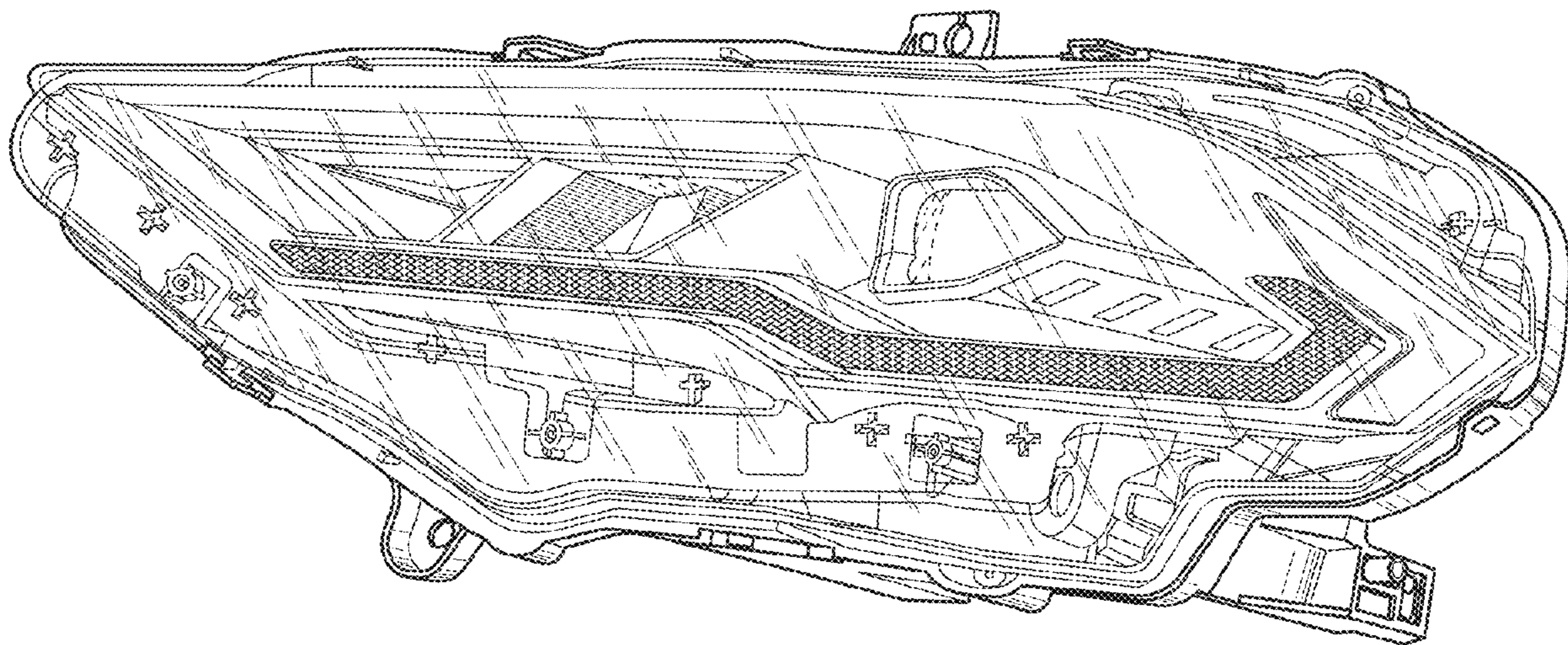

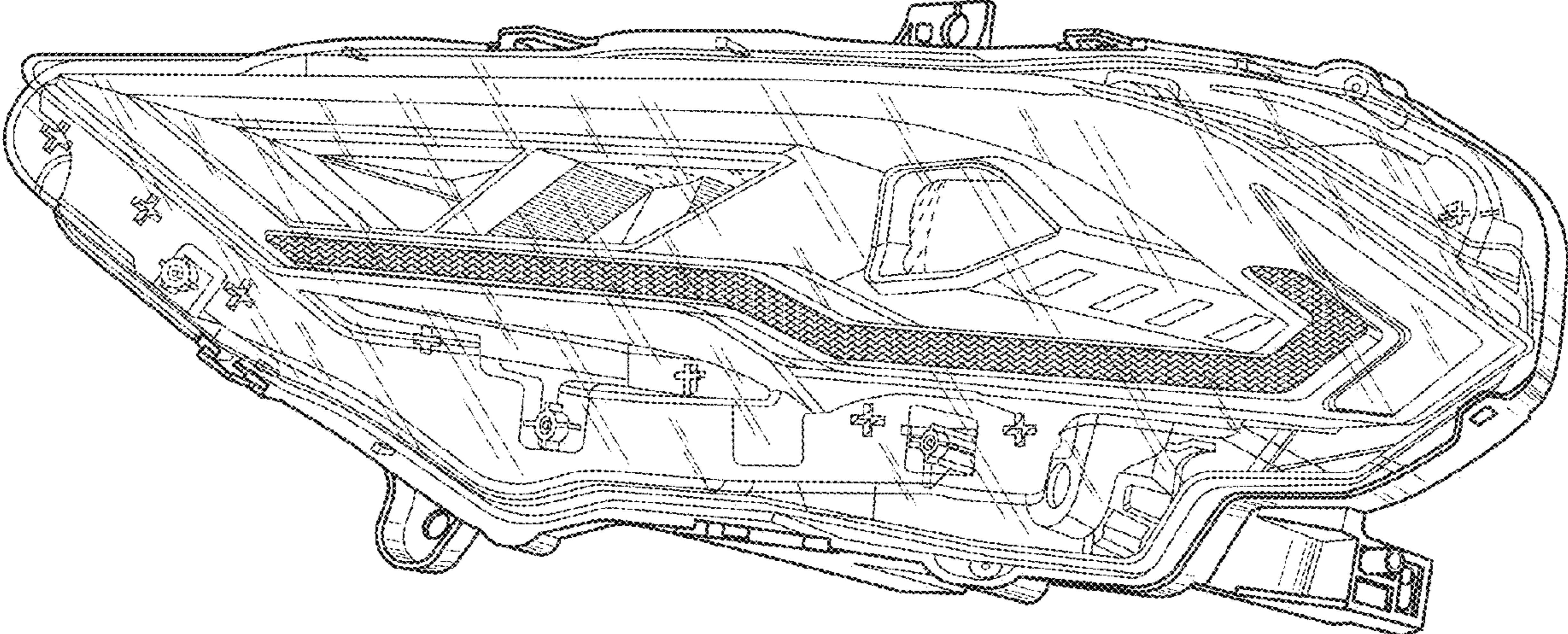

FIG. 1

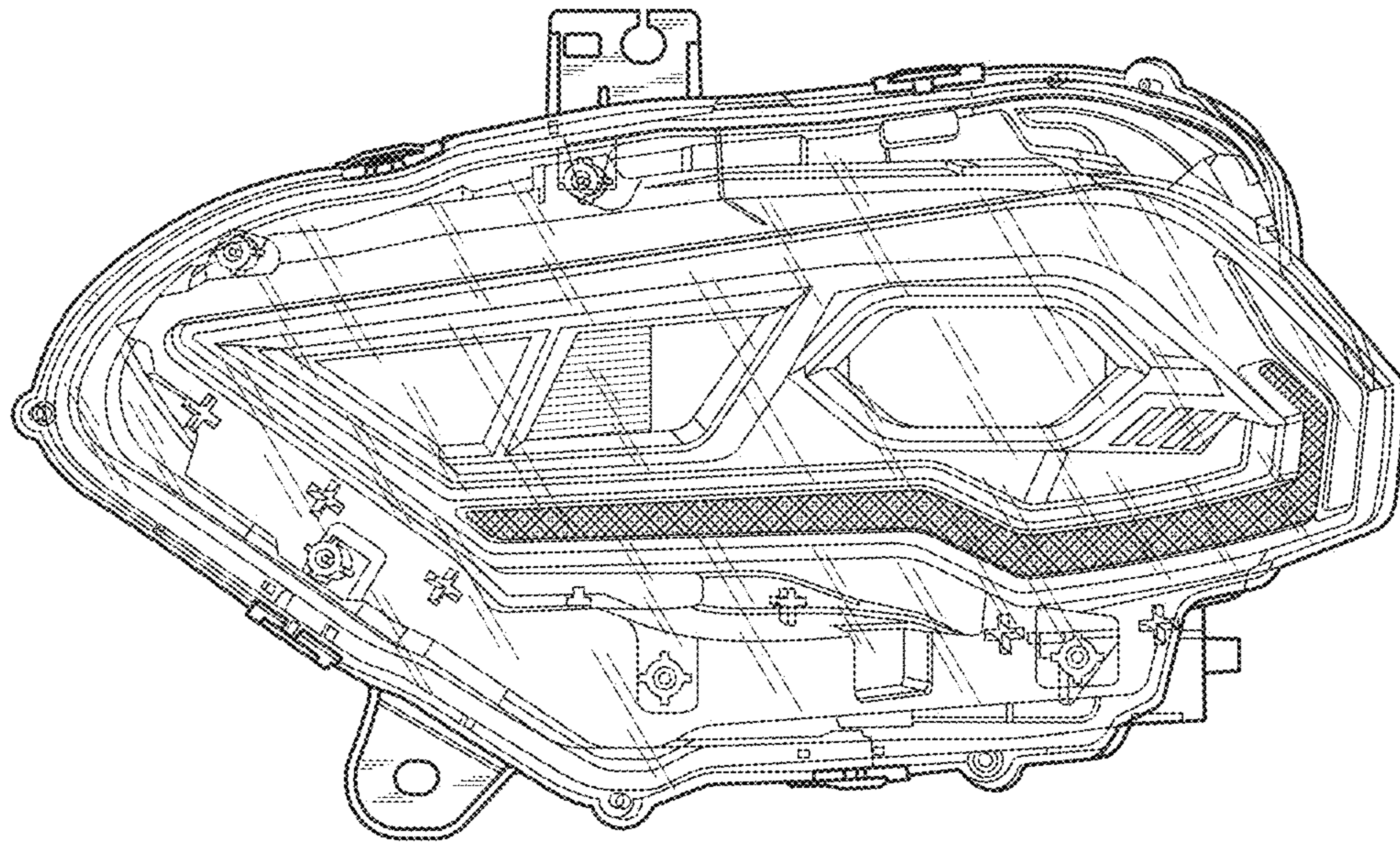

FIG. 2

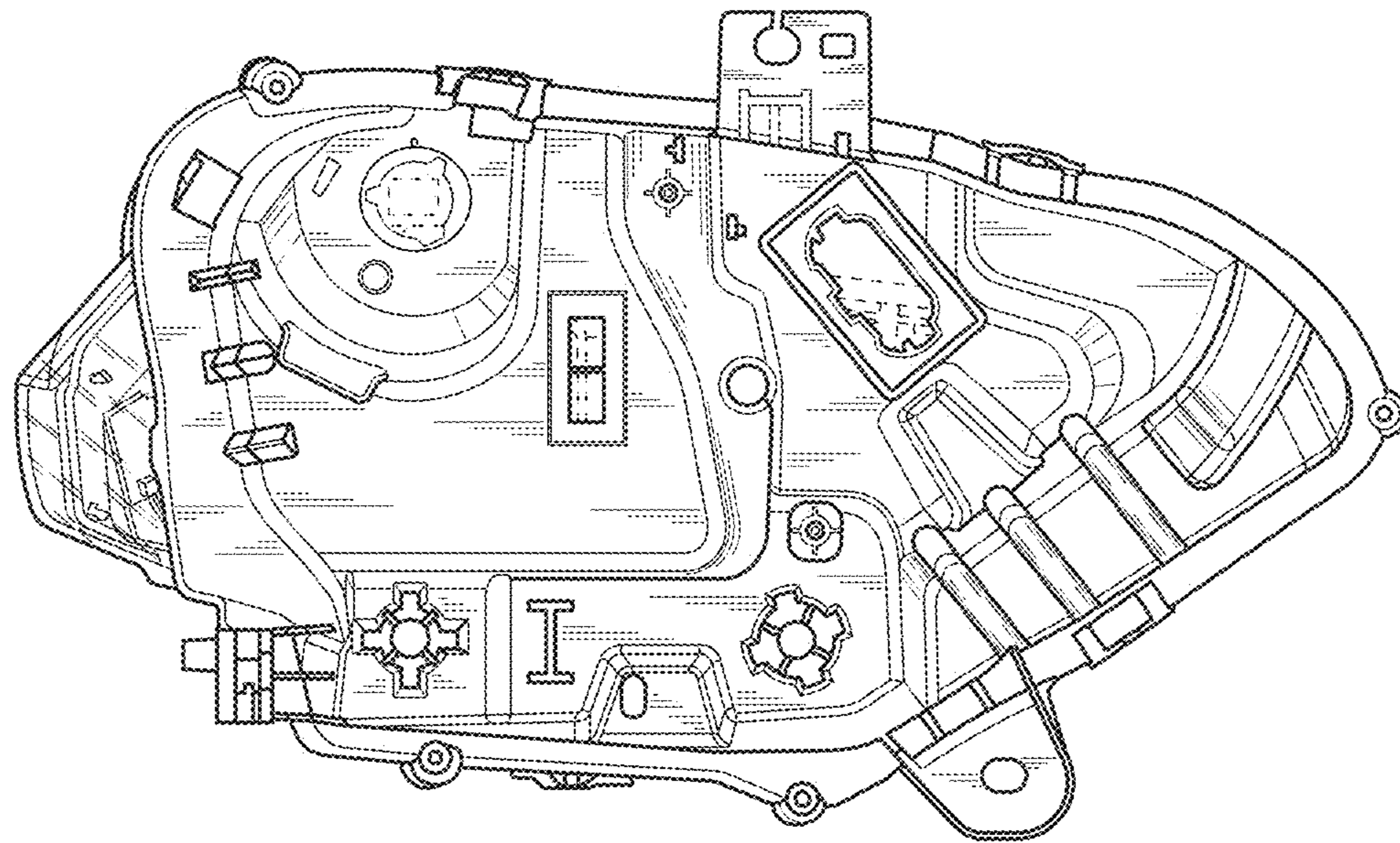

FIG. 3

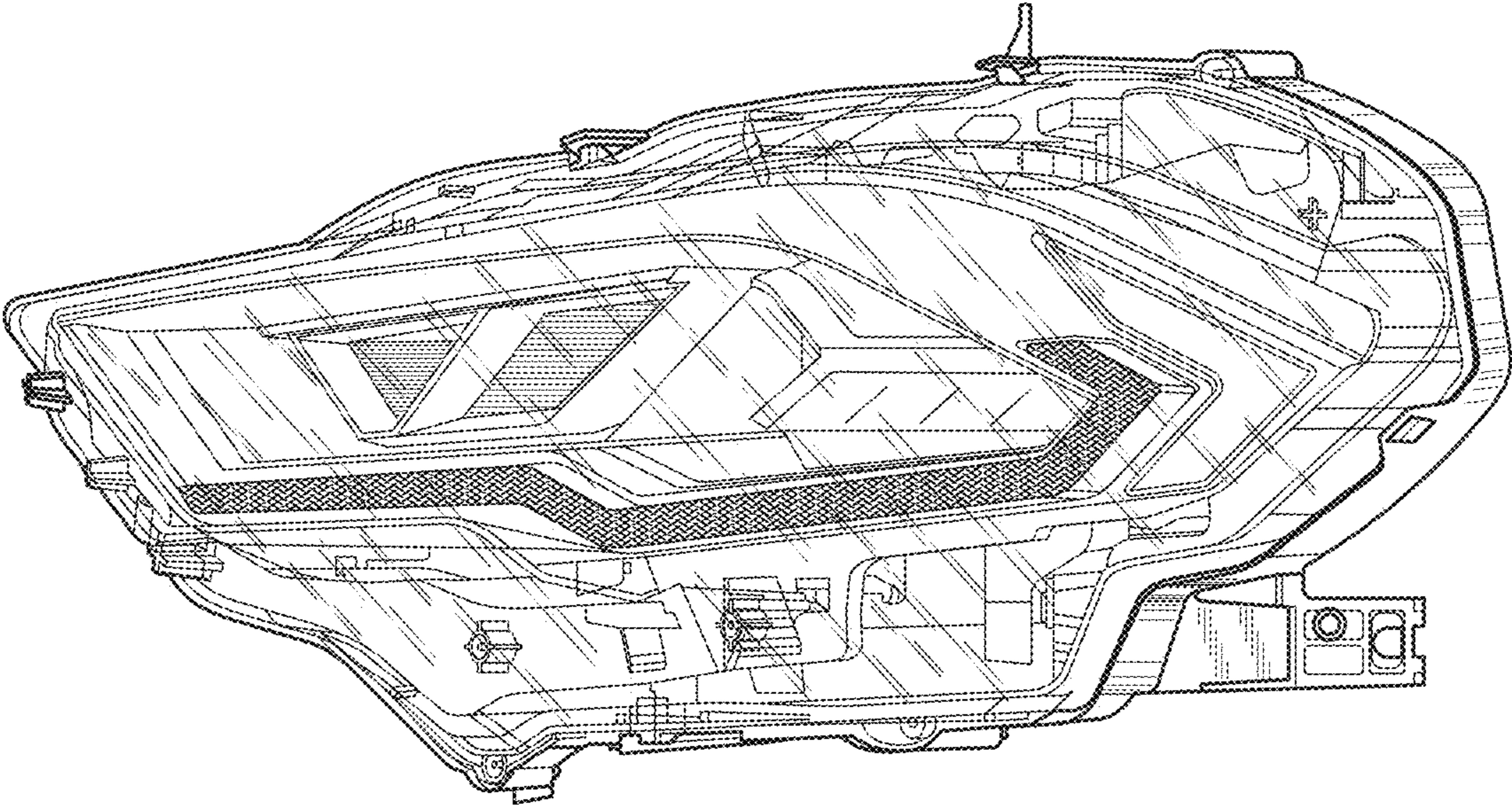

FIG. 4

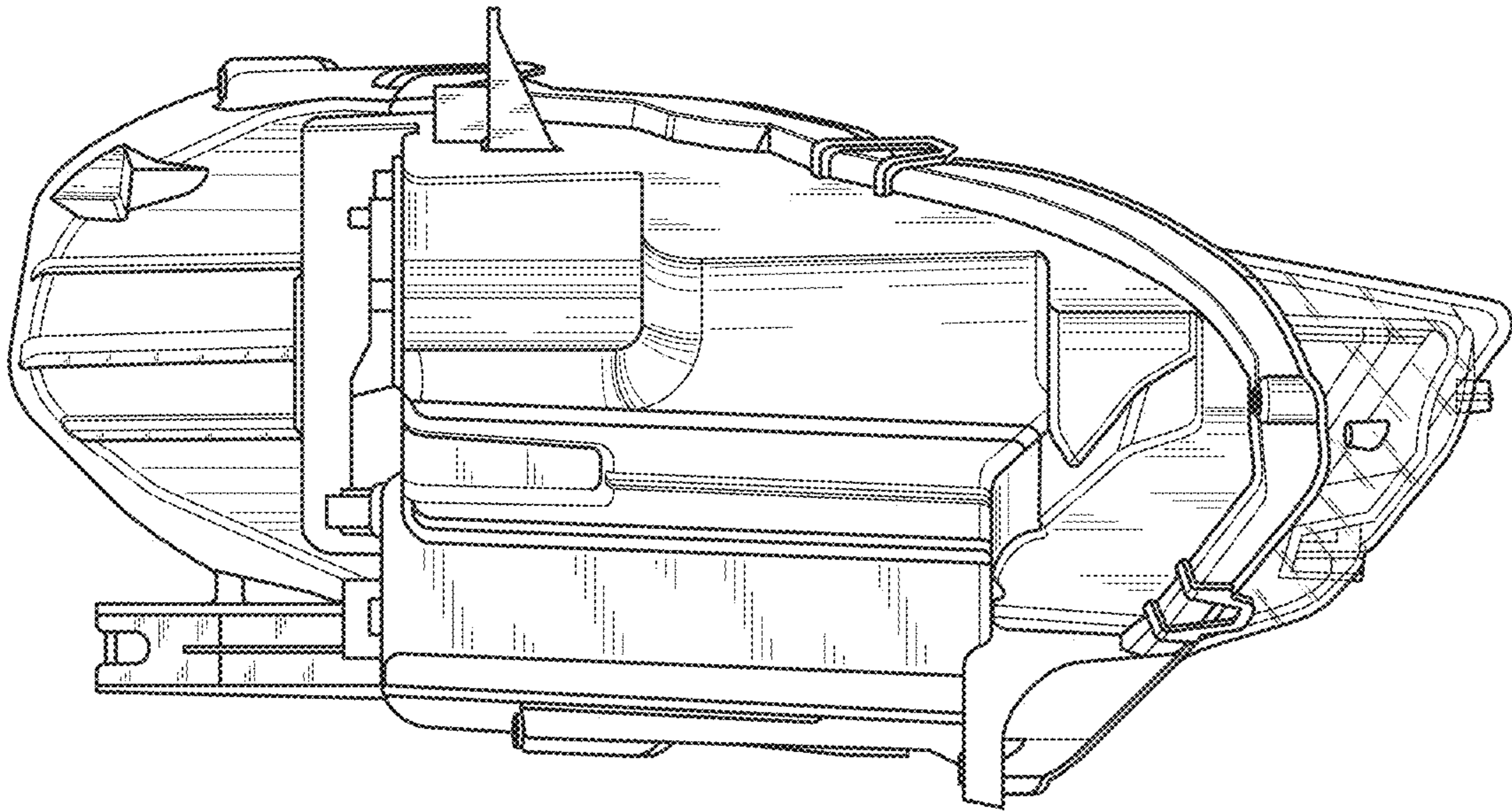

FIG. 5

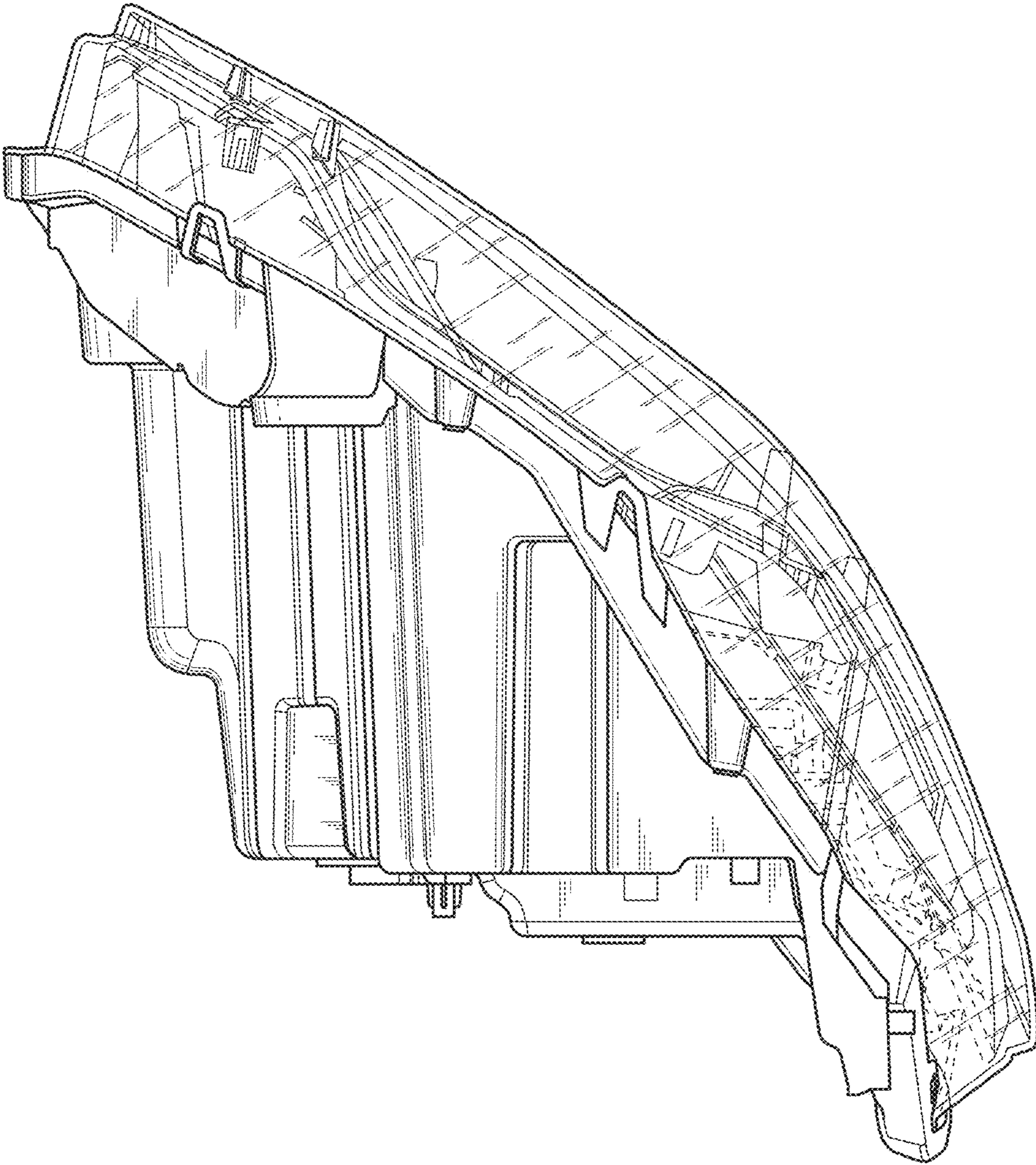

FIG. 6

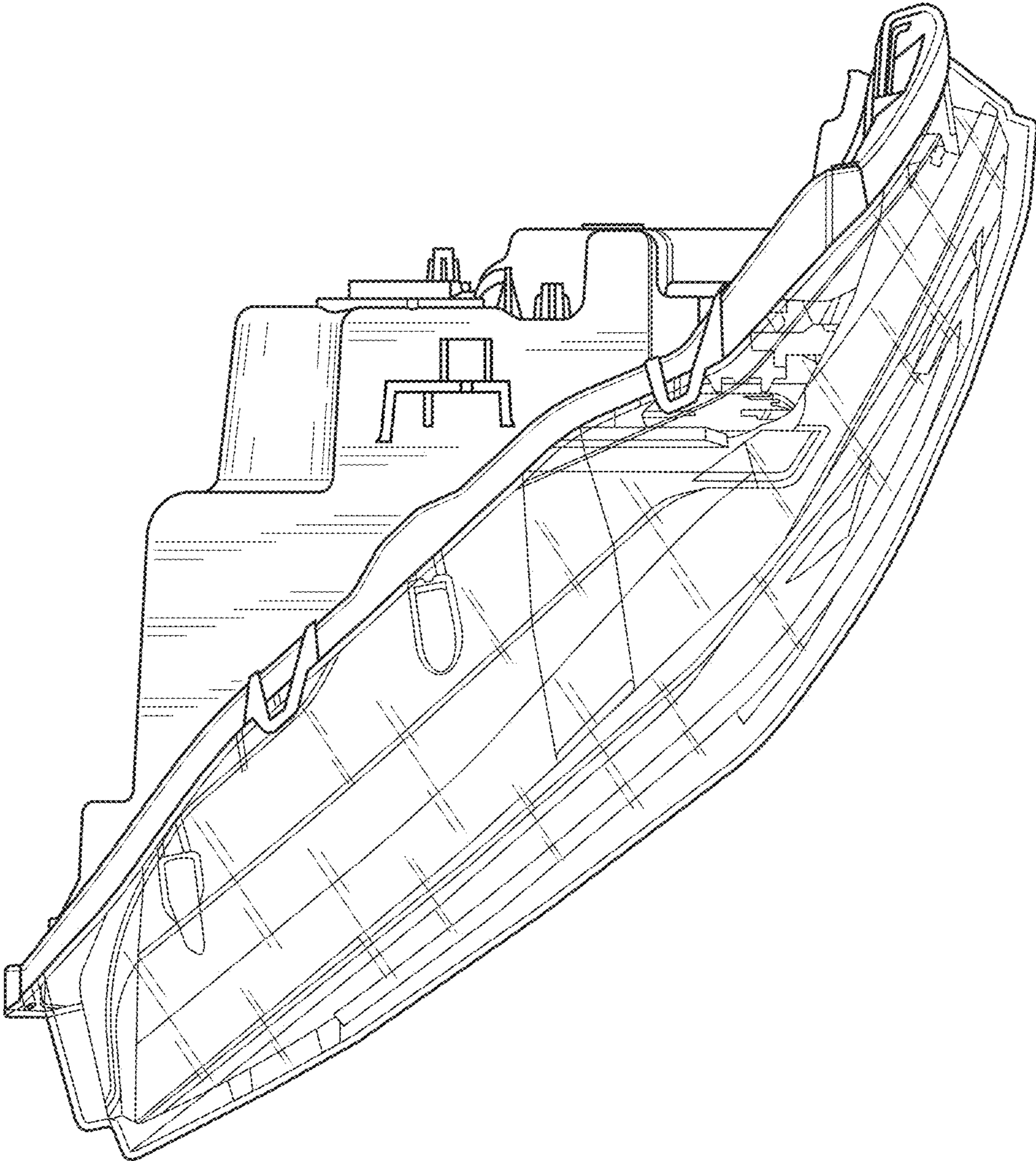

FIG. 7

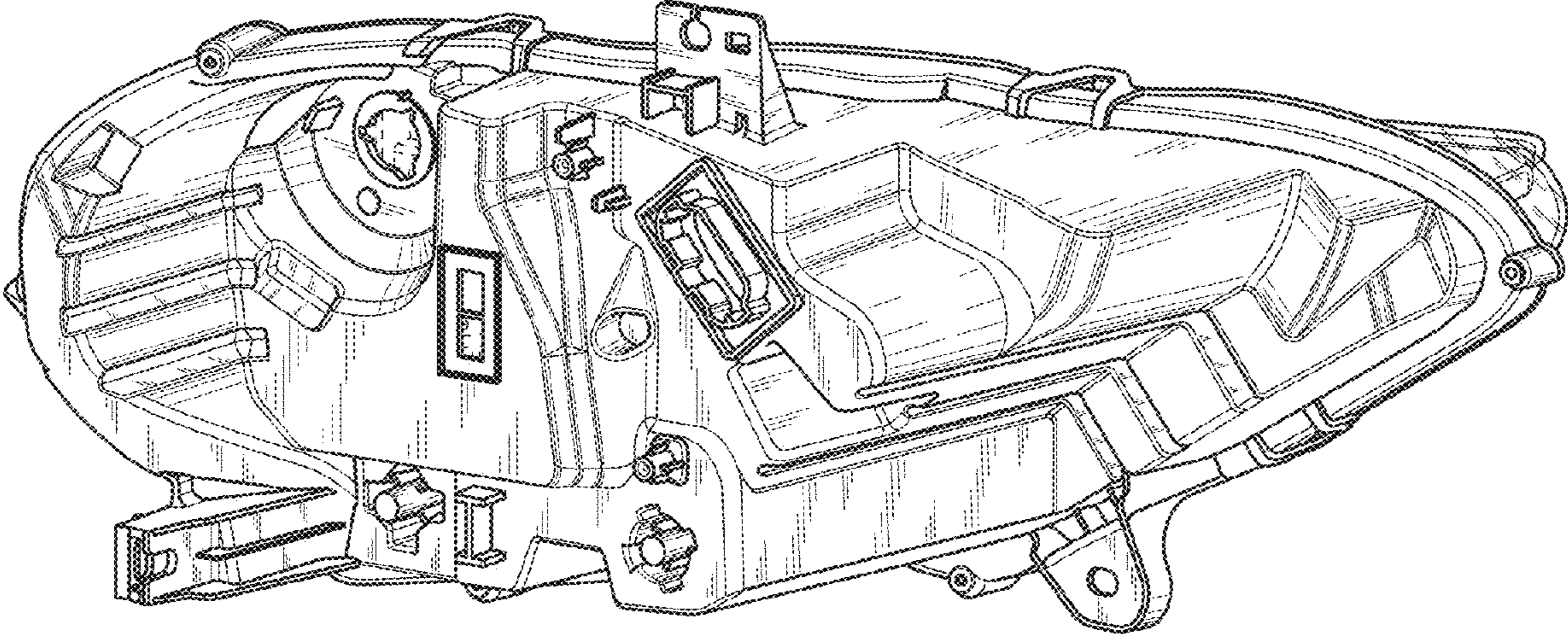

FIG. 8