



US00D963889S

(12) **United States Design Patent**
Park et al.

(10) **Patent No.:** **US D963,889 S**
(45) **Date of Patent:** **** Sep. 13, 2022**

(54) **INDOOR WALL WITH BUILT-IN HOME APPLIANCES**

(71) Applicant: **LG ELECTRONICS INC.**, Seoul (KR)

(72) Inventors: **Kyusuh Park**, Seoul (KR); **Junghan Ryu**, Seoul (KR); **Yunjoo Kim**, Seoul (KR); **Taeho Kim**, Seoul (KR); **Kisang Jung**, Seoul (KR); **Hwasuk Shim**, Seoul (KR); **Youngyoung Kim**, Seoul (KR); **Jipyo Hong**, Seoul (KR); **Chulmin Lim**, Seoul (KR); **Bumsang Lee**, Seoul (KR); **Mijin Jung**, Seoul (KR); **Junghyun Joo**, Seoul (KR); **Jaemyo Shim**, Seoul (KR); **Junki Kim**, Seoul (KR)

(73) Assignee: **LG ELECTRONICS INC.**, Seoul (KR)

(**) Term: **15 Years**

(21) Appl. No.: **29/729,252**

(22) Filed: **Mar. 25, 2020**

(30) **Foreign Application Priority Data**

Sep. 26, 2019 (KR) 30-2019-0046488

(51) **LOC (13) Cl.** **25-02**

(52) **U.S. Cl.**
USPC **D25/58; D14/217**

(58) **Field of Classification Search**
USPC D6/329, 332, 553, 559, 672, 673, 675;
D13/162, 164, 171, 177, 199; D14/128,
(Continued)

(56) **References Cited**

U.S. PATENT DOCUMENTS

D191,502 S * 10/1961 Rutkin D25/58
D299,758 S * 2/1989 Kelley D25/48.7

(Continued)

Primary Examiner — Leanne Was-Englehart

(74) *Attorney, Agent, or Firm* — Birch Stewart Kolasch & Birch, LLP

(57) **CLAIM**

The ornamental design for an indoor wall with built-in home appliances, as shown and described.

DESCRIPTION

FIG. 1 is a front perspective view of the indoor wall with built-in home appliances showing our new design; FIG. 2 is a front view thereof; FIG. 3 is a rear view thereof; FIG. 4 is a left side view thereof where the right side view is a mirror image; FIG. 5 is a top view thereof; FIG. 6 is a bottom view thereof; FIG. 7 is a front perspective view in a condition that the drawer at the front bottom has been opened and the projector has been exposed; FIG. 8 is a front view of FIG. 7; FIG. 9 is a rear view of FIG. 7; FIG. 10 is a left side view of FIG. 7 where the right view is a mirror image; FIG. 11 is a top view of FIG. 7; FIG. 12 is a bottom view of FIG. 7; and, FIG. 13 is a reference view showing the use state that the front part of the claimed design is used as a screen by operating the projector. The dash-dash broken lines in FIG. 13 of an image on the screen depict environment that forms no part of the claimed design. The remaining dash-dash broken lines in the figures depict portions of the indoor wall with built-in home appliances that form no part of the claimed design. The dash-dot broken lines define the bounds of the claimed design and form no part thereof.

1 Claim, 13 Drawing Sheets

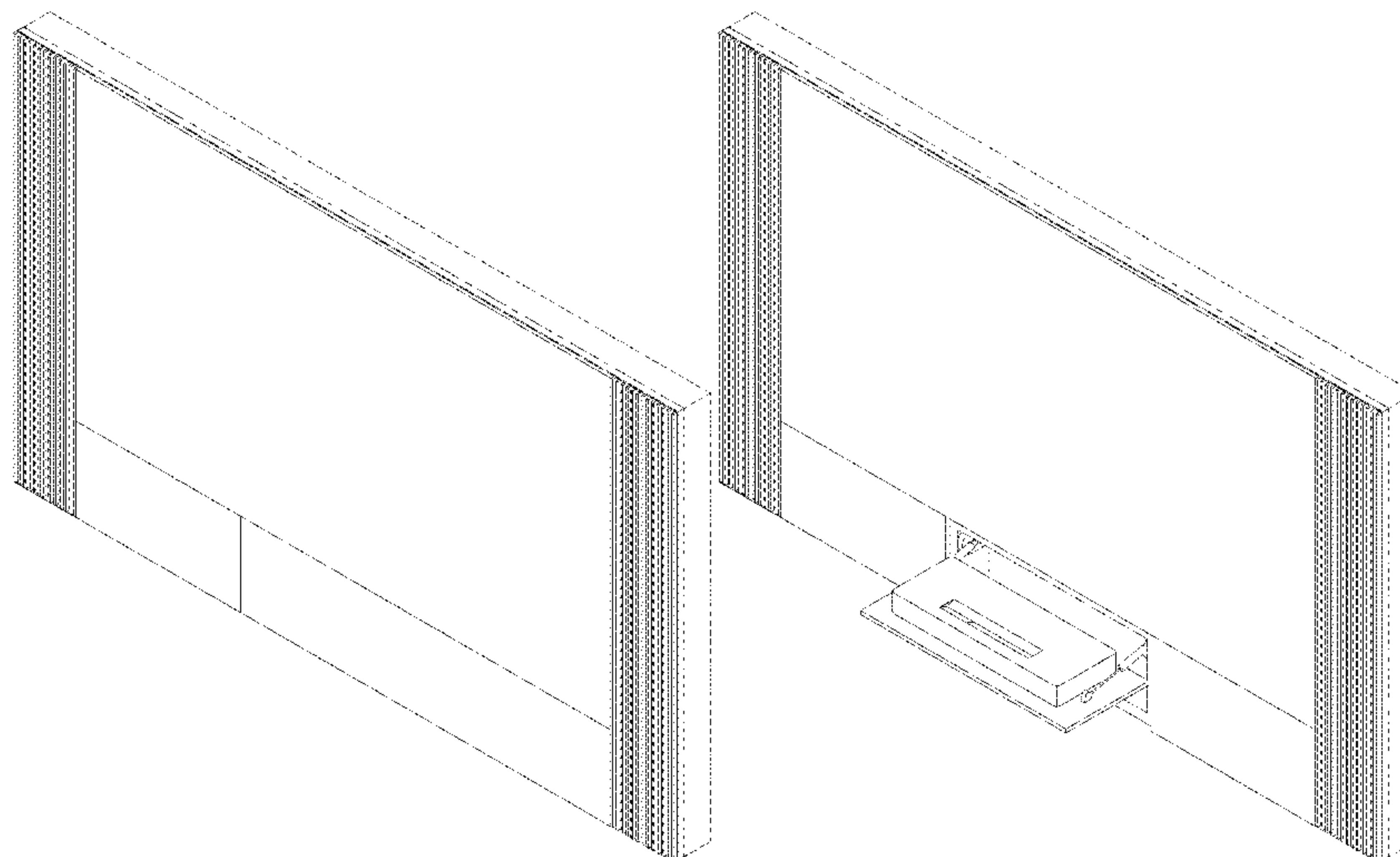

(58) **Field of Classification Search**

USPC D14/129, 217, 366, 371, 374, 389,
D14/432-434; D25/58, 138, 199

CPC H04N 5/64; A47B 81/06; A47B 96/04;
E04B 2/00; E04B 2/72; E04B 2/74;
H05K 7/18; H05K 7/186

See application file for complete search history.

(56) **References Cited**

U.S. PATENT DOCUMENTS

D330,646 S * 11/1992 Maas D25/58
D395,453 S * 6/1998 Kawasaki D14/374
D495,331 S * 8/2004 Liu D14/371
D497,147 S * 10/2004 Izu D14/128
8,375,648 B1 * 2/2013 O'Sullivan G09F 15/0006
52/71
D805,655 S * 12/2017 Balas D25/48.3
D900,062 S * 10/2020 Park D14/217
10,932,385 B1 * 2/2021 Kim E04B 2/58
D922,356 S * 6/2021 Lee D14/217
D931,663 S * 9/2021 Tio D6/675
D938,389 S * 12/2021 Park D14/217
D938,390 S * 12/2021 Park D14/217
D938,391 S * 12/2021 Park D14/217
D938,392 S * 12/2021 Park D14/217
D938,393 S * 12/2021 Park D14/217
D938,394 S * 12/2021 Park D14/217
D938,395 S * 12/2021 Park D14/217
D938,396 S * 12/2021 Kim D14/217
2020/0344910 A1 * 10/2020 Joo E04B 2/74

* cited by examiner

FIG. 1

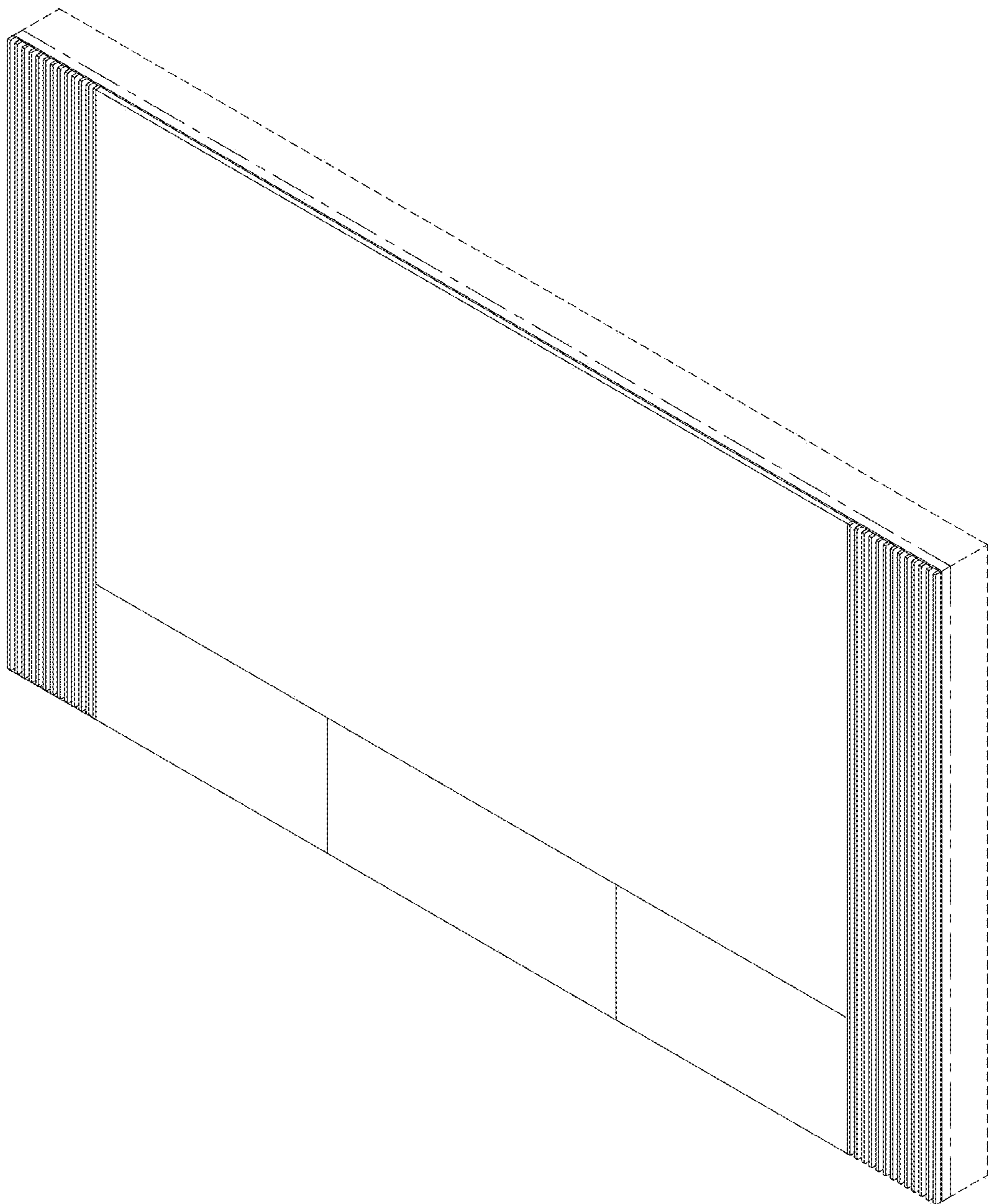

FIG. 2

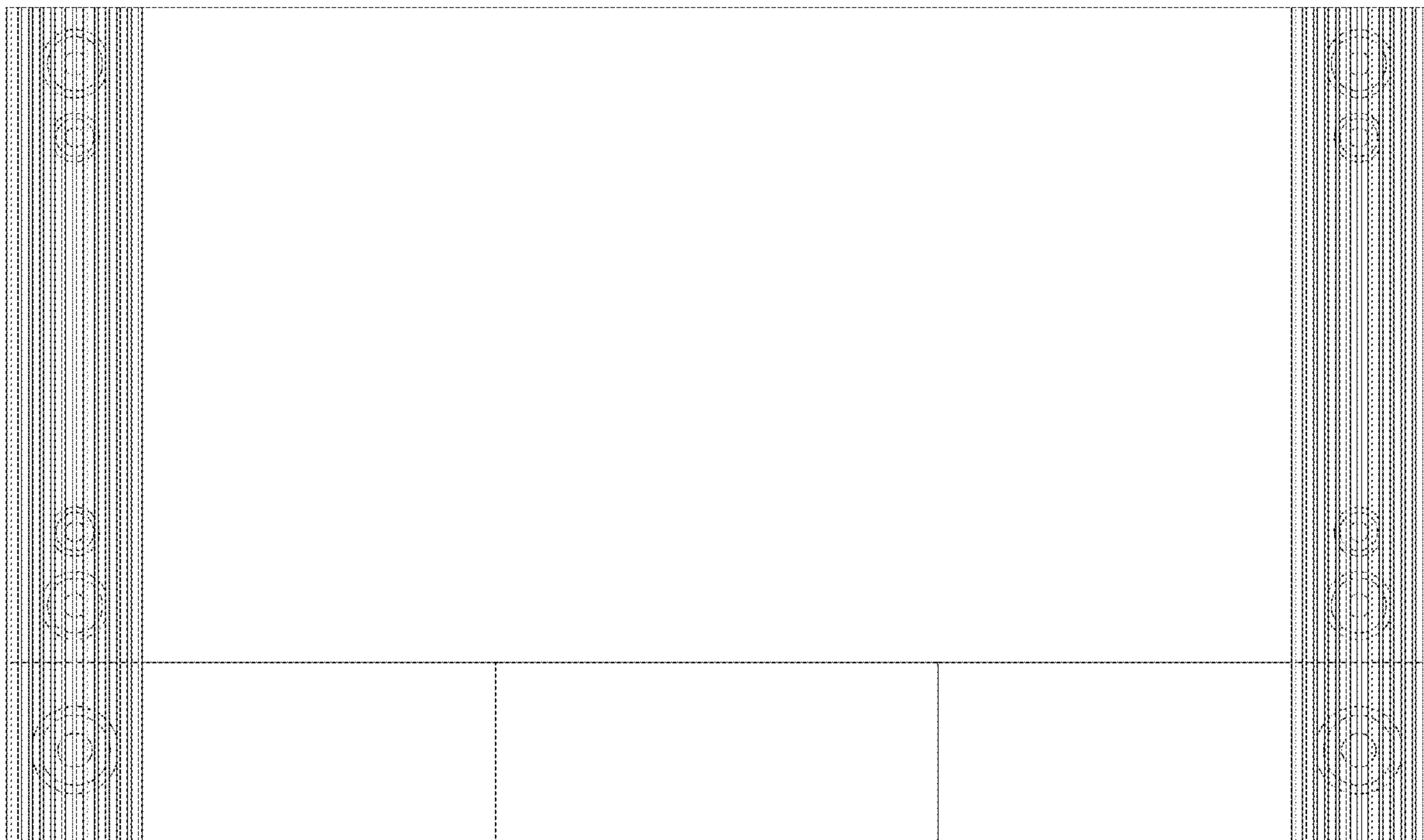

FIG. 3

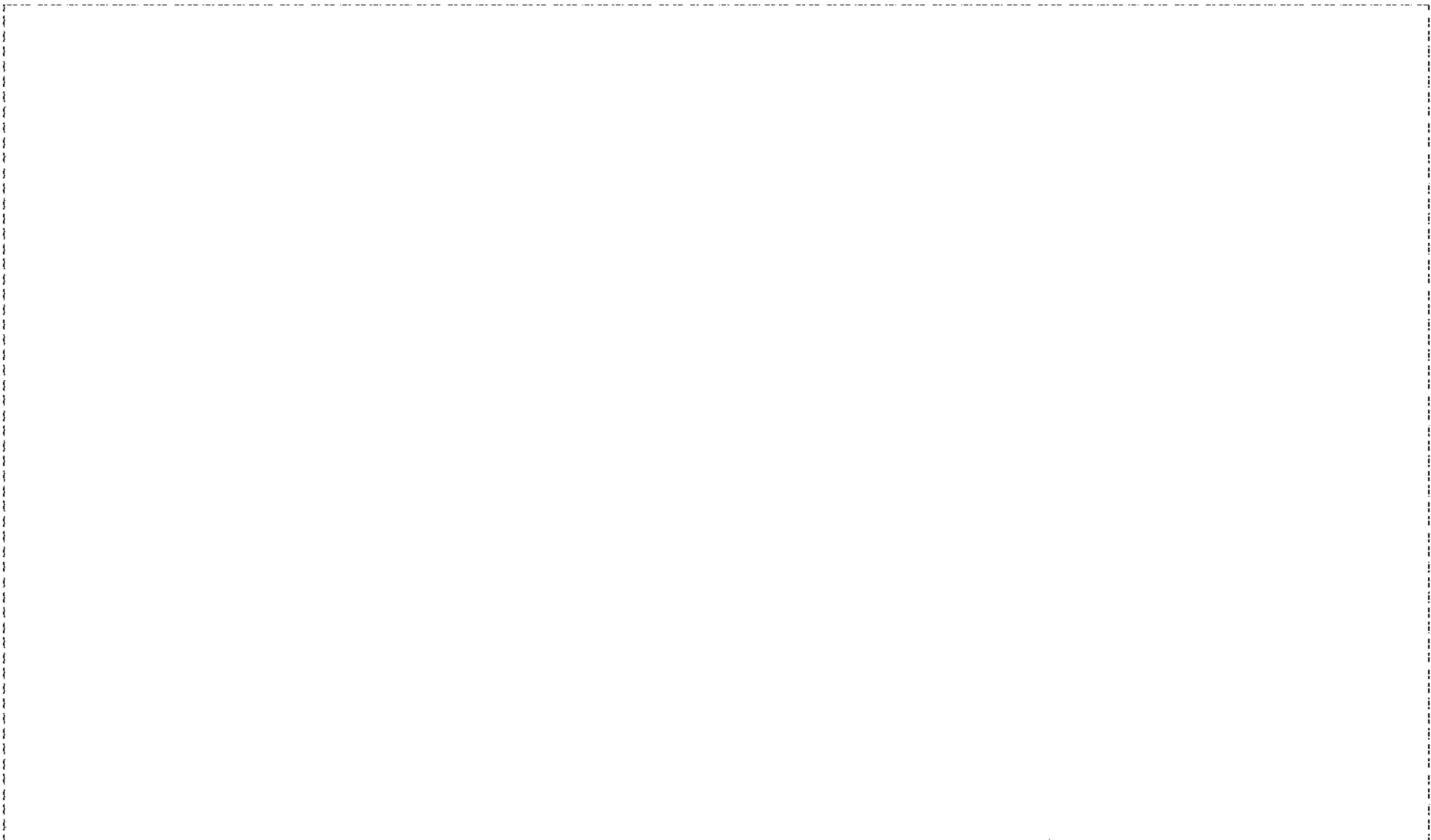

FIG. 4

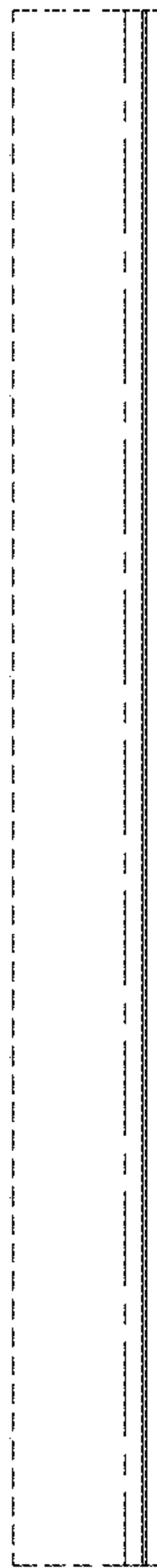

FIG. 5



FIG. 6

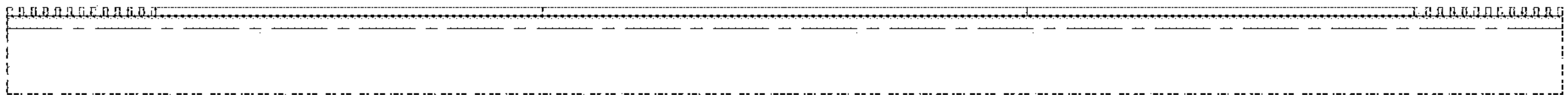

FIG. 7

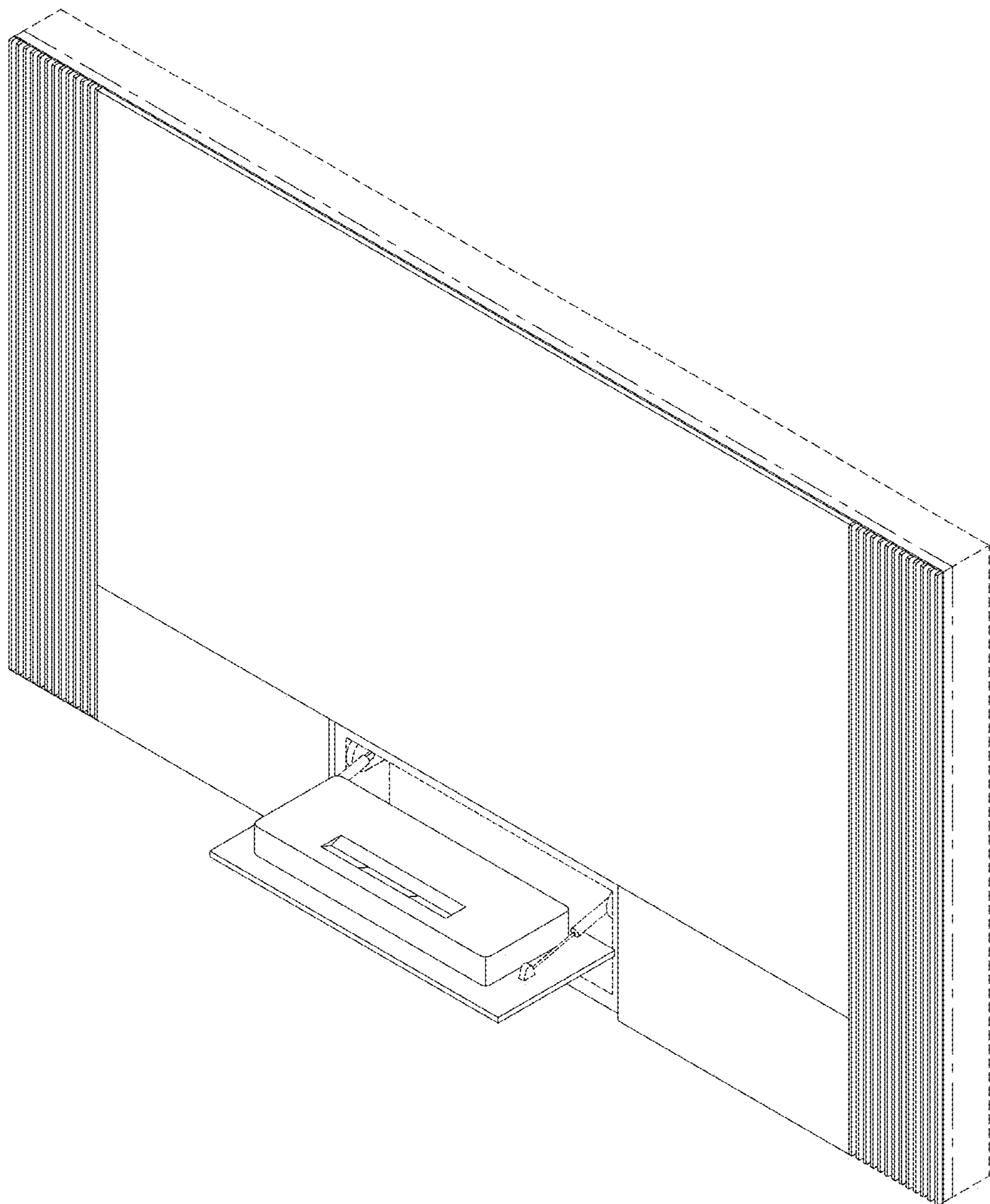

FIG. 8

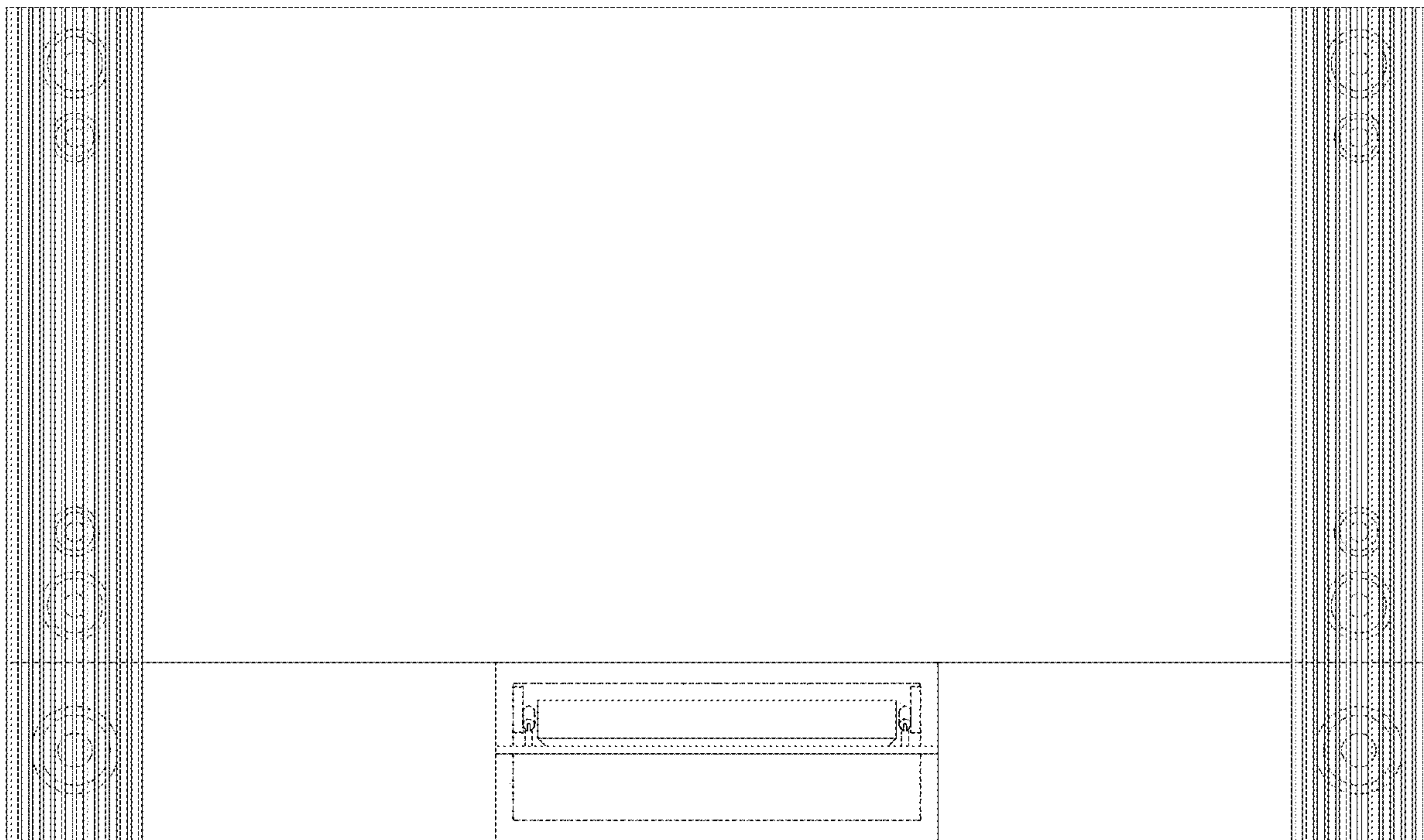

FIG. 9

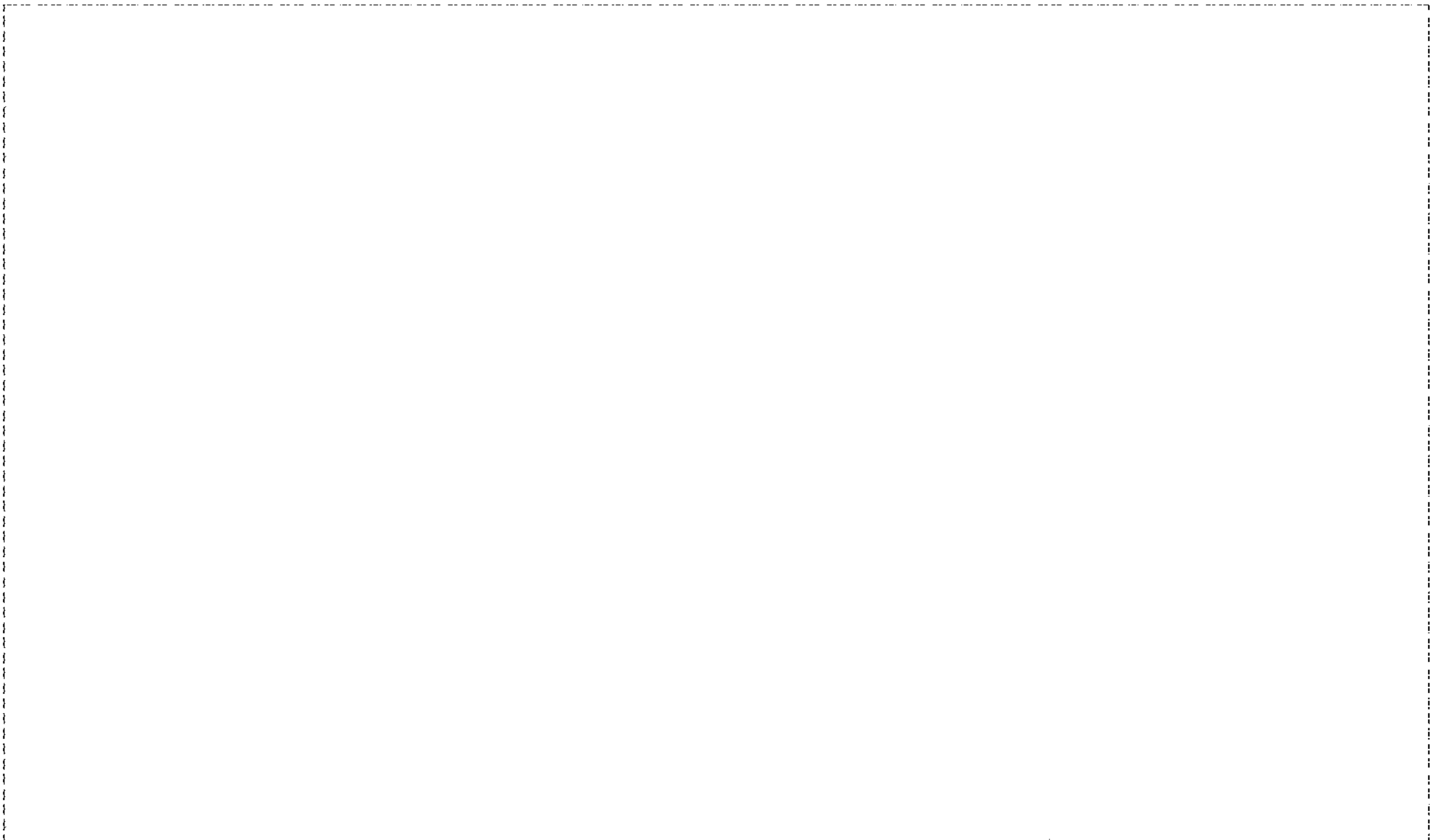

FIG. 10

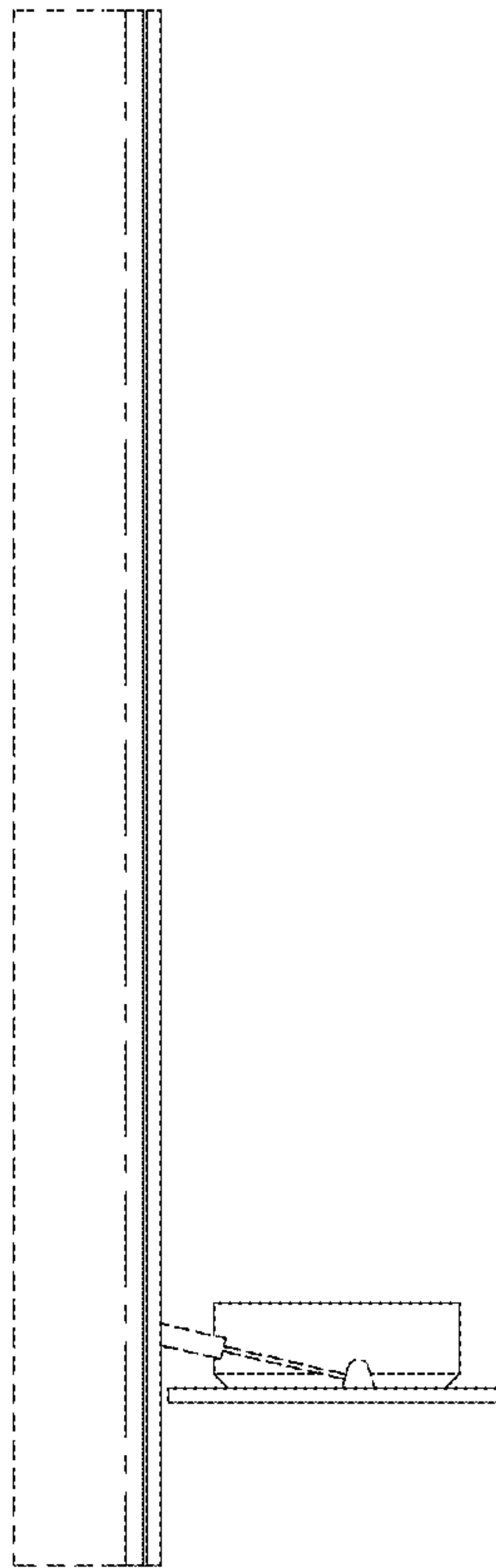

FIG. 11

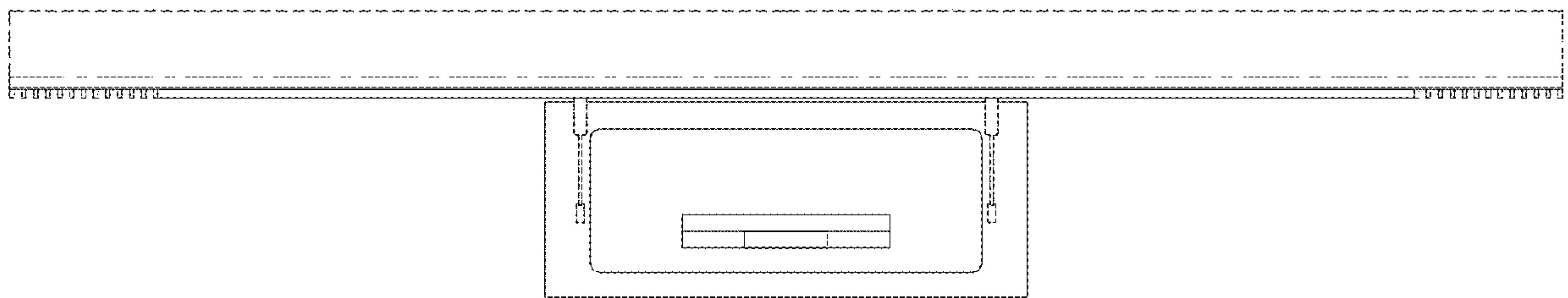

FIG. 12

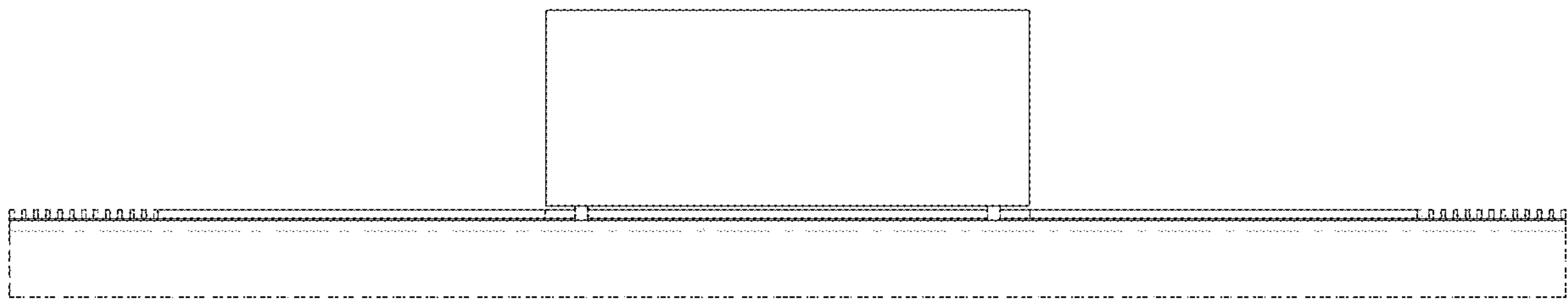

FIG. 13

