

US00D963866S

(12) **United States Design Patent** (10) **Patent No.:** **US D963,866 S**
Skelton (45) **Date of Patent:** **** Sep. 13, 2022**

(54) **SLIDE MEMBER OF AN ADJUSTABLE FINGER SPLINT**

(71) Applicant: **Andrew C. Skelton**, Austin, TX (US)

(72) Inventor: **Andrew C. Skelton**, Austin, TX (US)

(**) Term: **15 Years**

(21) Appl. No.: **29/707,785**

(22) Filed: **Oct. 1, 2019**

Related U.S. Application Data

(63) Continuation of application No. 16/486,042, filed as application No. PCT/US2019/015939 on Jan. 31, 2019.

(51) **LOC (13) Cl.** **24-01**

(52) **U.S. Cl.**
USPC **D24/190**

(58) **Field of Classification Search**
USPC D24/190-192
See application file for complete search history.

(56) **References Cited**

U.S. PATENT DOCUMENTS

4,384,571	A	5/1983	Nuzzo et al.	
4,558,694	A	12/1985	Barber	
D310,263	S *	8/1990	Ellis	D24/190
D310,883	S *	9/1990	Ellis	D24/190
5,038,764	A	8/1991	Paez	
5,197,943	A *	3/1993	Link	A61F 5/05875 2/21
5,232,436	A *	8/1993	Janevski	A61F 5/013 602/22
6,561,995	B1	5/2003	Thibodo, Jr.	
6,575,925	B1 *	6/2003	Noble	A61F 5/05875 602/23
7,878,997	B2 *	2/2011	Bolla	A61F 5/10 602/22

D715,951	S *	10/2014	Stuart	D24/190
D843,589	S *	3/2019	Han	D24/190
D844,153	S *	3/2019	Han	D24/190
10,363,158	B1 *	7/2019	Rhinier	A61F 5/013
2014/0267116	A1 *	9/2014	Weiner	A61F 5/05875 345/173
2017/0281386	A1 *	10/2017	Salido, III	A61F 5/013
2020/0390583	A1 *	12/2020	Skelton	A61F 5/013

FOREIGN PATENT DOCUMENTS

GB 1326351 8/1973

OTHER PUBLICATIONS

European Office Action dated Sep. 8, 2020 for European Patent Application No. 19705649.2, a counterpart foreign application of U.S. Appl. No. 16/486,042, 3 pages.

* cited by examiner

Primary Examiner — Jennifer L Watkins
(74) *Attorney, Agent, or Firm* — Lee & Hayes, P.C.

(57) **CLAIM**

The ornamental design for a slide member of an adjustable finger splint, as shown and described.

DESCRIPTION

FIG. 1 is a perspective view of a slide member of an adjustable finger splint, taken from the back.
FIG. 2 is a front view thereof;
FIG. 3 is a back view thereof;
FIG. 4 is a left-side view thereof;
FIG. 5 is a right-side view thereof;
FIG. 6 is a top view thereof; and,
FIG. 7 is a bottom view thereof.
The dashed broken lines depict portions of a slide member of an adjustable firmer splint and form no part of the claim.

1 Claim, 7 Drawing Sheets

104 →

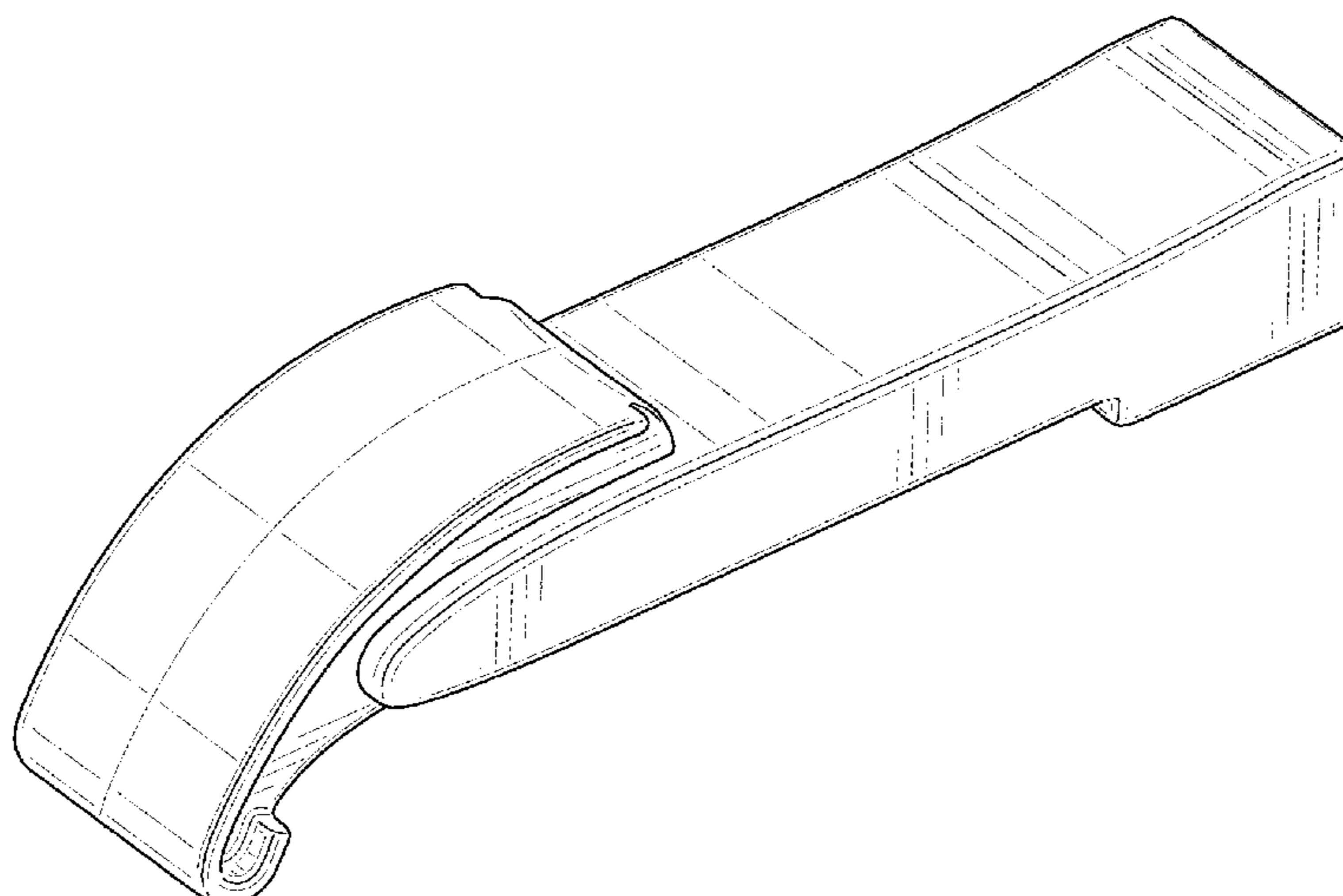

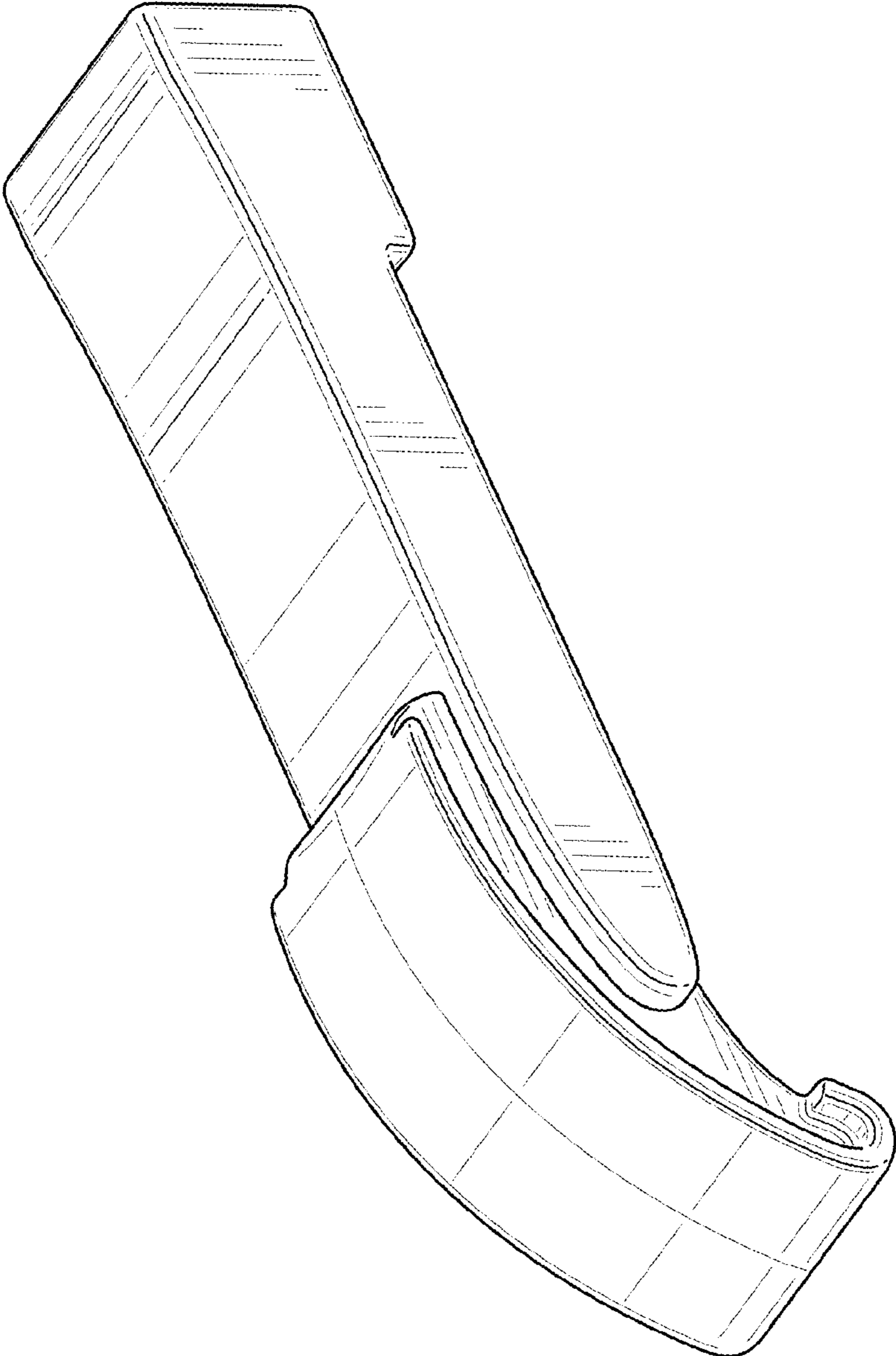

104

FIG. 1

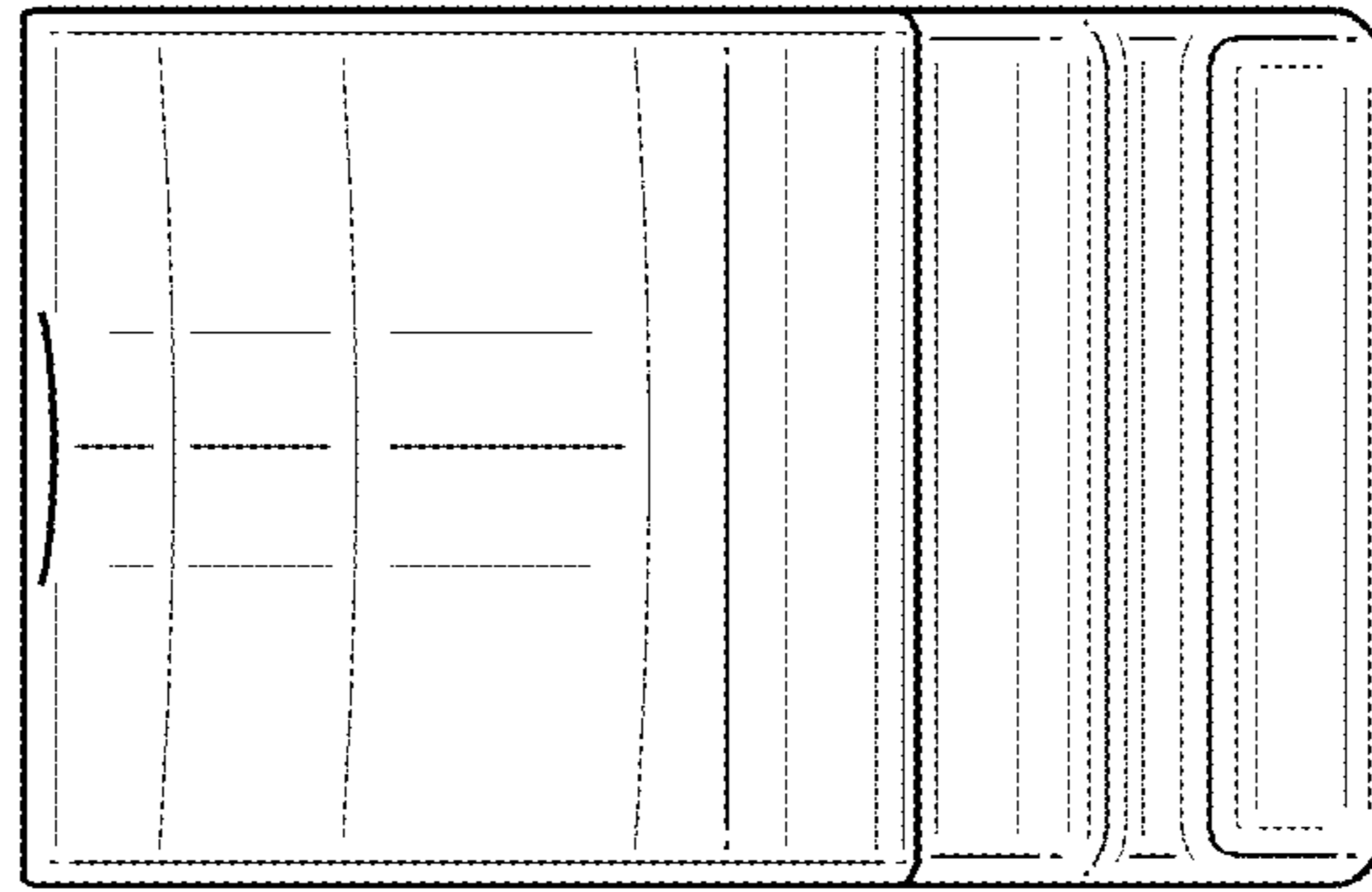

FIG. 2

104 →

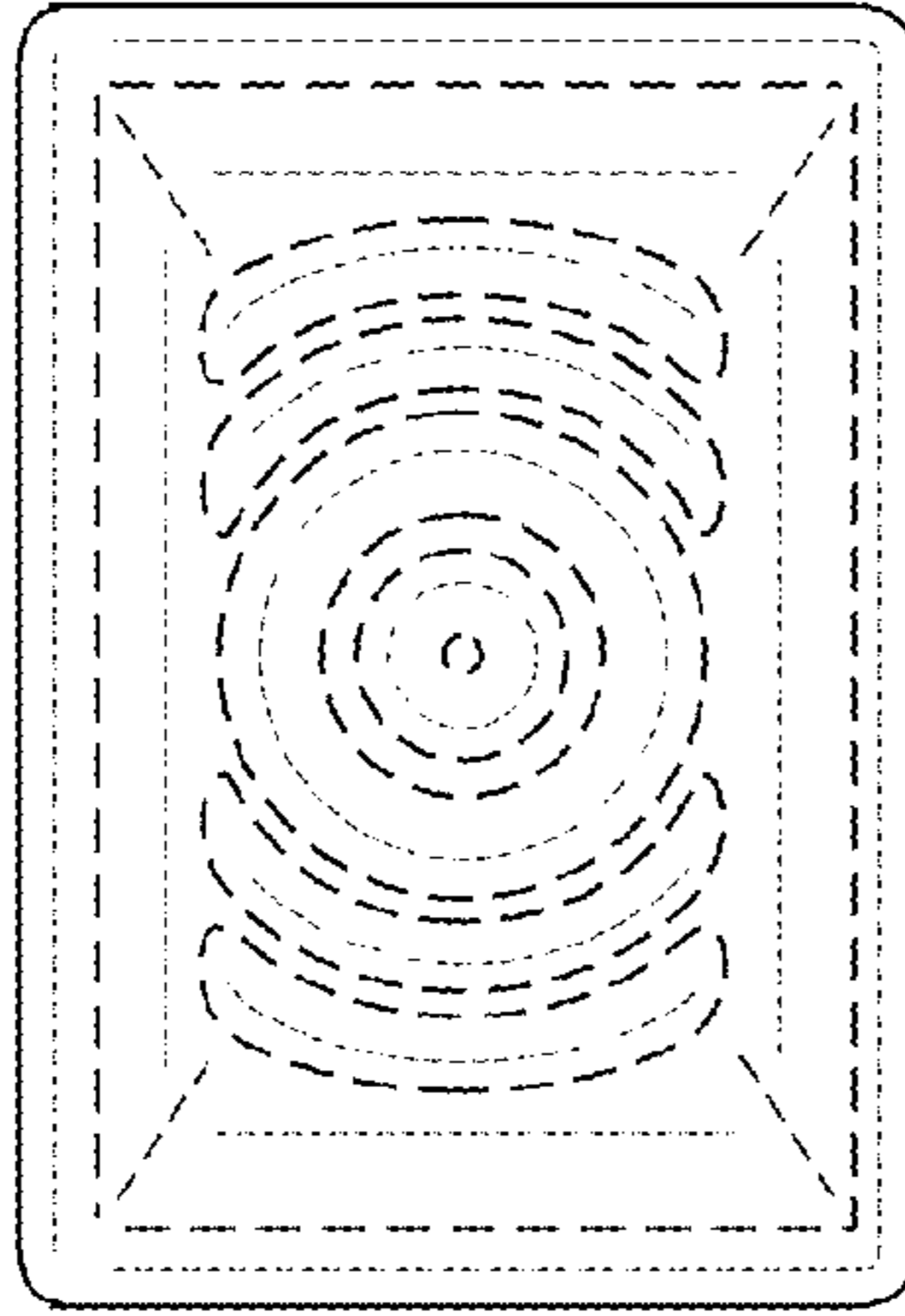

FIG. 3

104

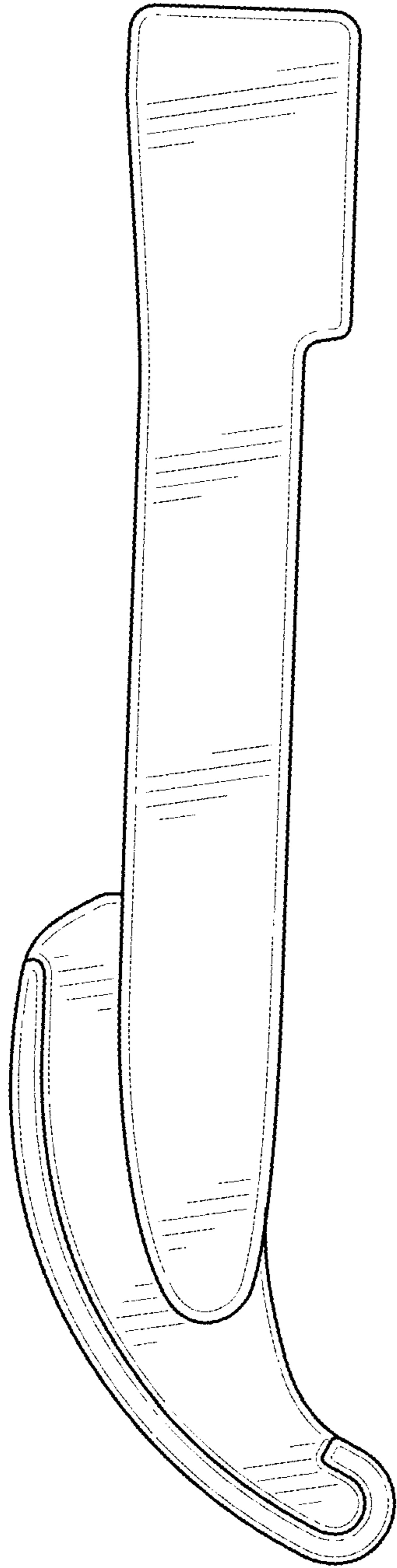

FIG. 4

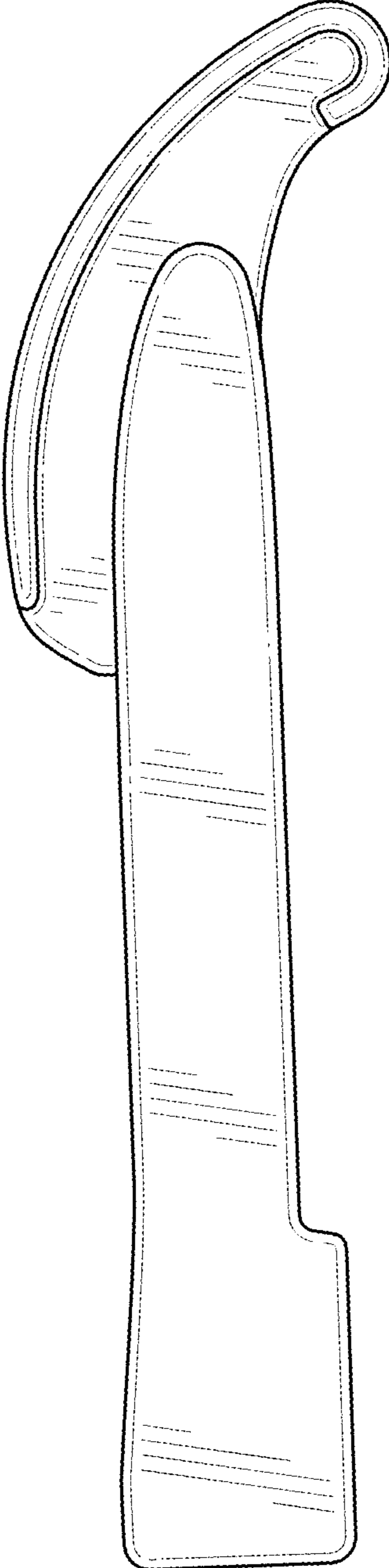

FIG. 5

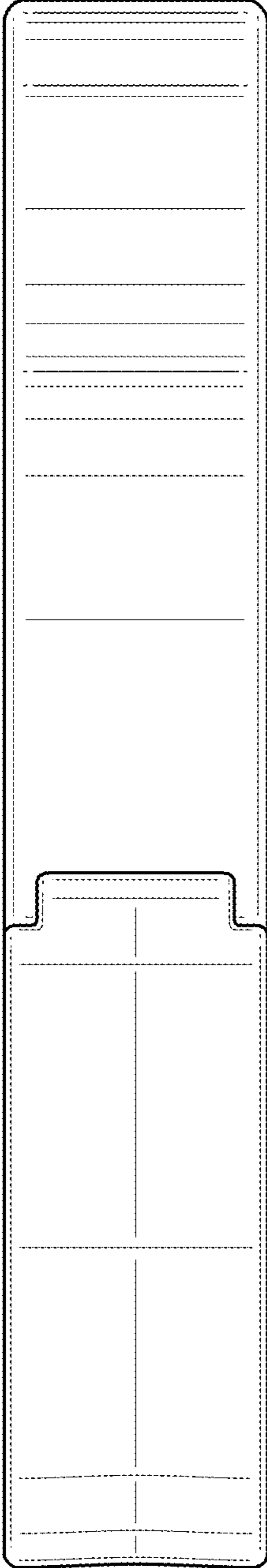

FIG. 6

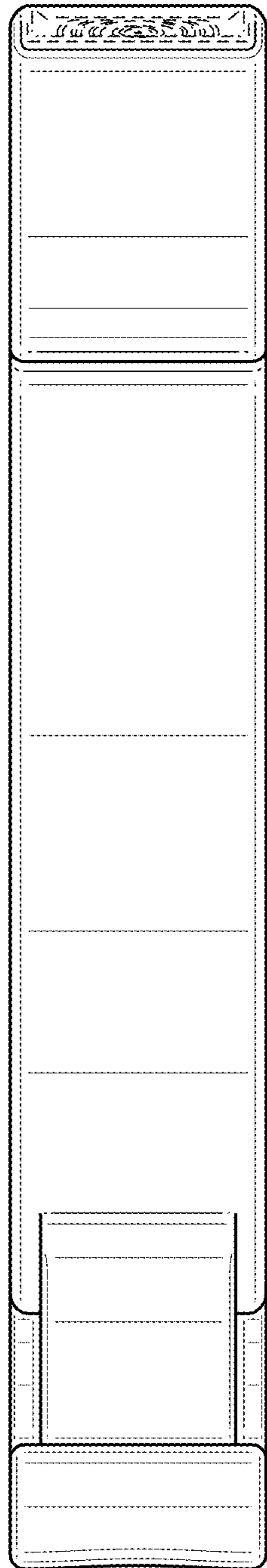

FIG. 7