



US00D963801S

(12) **United States Design Patent**  
**Chang**

(10) **Patent No.:** **US D963,801 S**

(45) **Date of Patent:** **\*\* Sep. 13, 2022**

(54) **FAUCET**

(71) Applicant: **Juanhong Chang**, Suzhou (CN)

(72) Inventor: **Juanhong Chang**, Suzhou (CN)

(\*\*) Term: **15 Years**

(21) Appl. No.: **29/864,535**

(22) Filed: **Jun. 2, 2022**

(51) **LOC (13) Cl.** ..... **23-01**

(52) **U.S. Cl.**  
USPC ..... **D23/241**

(58) **Field of Classification Search**  
USPC ..... D23/238-243, 250, 252, 254-255, 257;  
D8/307-308

See application file for complete search history.

(56) **References Cited**

**U.S. PATENT DOCUMENTS**

D684,668 S *	6/2013	Yu	.....	D23/242
D790,670 S *	6/2017	Downey	.....	D23/255
D800,262 S	10/2017	Andrew		
D865,127 S *	10/2019	Fang	.....	D23/242
D873,384 S *	1/2020	Guo	.....	D23/255
D896,349 S *	9/2020	Kuang	.....	D23/242
D912,213 S *	3/2021	Kuang	.....	D23/238
D922,530 S	6/2021	Lazarini		
D956,183 S *	6/2022	Yan	.....	D23/238

**OTHER PUBLICATIONS**

Signature Hardware, Pogosa Widespread waterfall faucet. [https://www.signaturehardware.com/hvasu-widespread-waterfall-faucet.html?pid=186469&gclid=EAIalQobChMk\\_fnqsyK-QIVUQelCR35AgQFEAwYAiABEgluH\\_D\\_BwE](https://www.signaturehardware.com/hvasu-widespread-waterfall-faucet.html?pid=186469&gclid=EAIalQobChMk_fnqsyK-QIVUQelCR35AgQFEAwYAiABEgluH_D_BwE) (Year: 2015).\*

\* cited by examiner

*Primary Examiner* — Robert A Delehanty

(57) **CLAIM**

The ornamental design for a faucet, as shown and described.

**DESCRIPTION**

FIG. 1 is a perspective view of a faucet showing my new design;

FIG. 2 is another perspective view thereof;

FIG. 3 is a front elevational view thereof;

FIG. 4 is a rear elevational view thereof;

FIG. 5 is a left side elevational view thereof;

FIG. 6 is a right side elevational view thereof;

FIG. 7 is a top plan view thereof; and,

FIG. 8 is a bottom plan view thereof.

The broken lines in the drawings depict portions of the faucet that form no part of the claimed design.

**1 Claim, 8 Drawing Sheets**

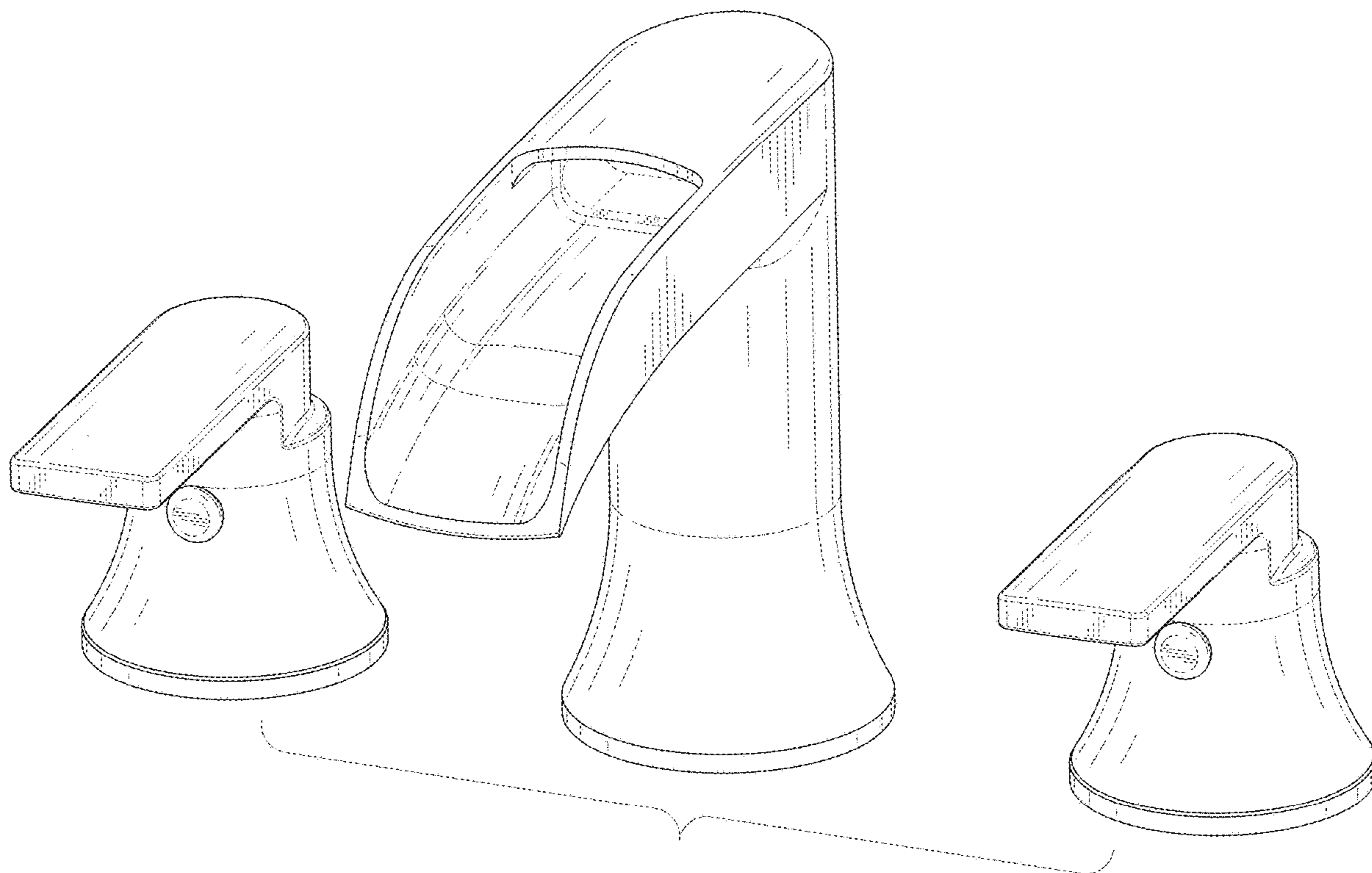

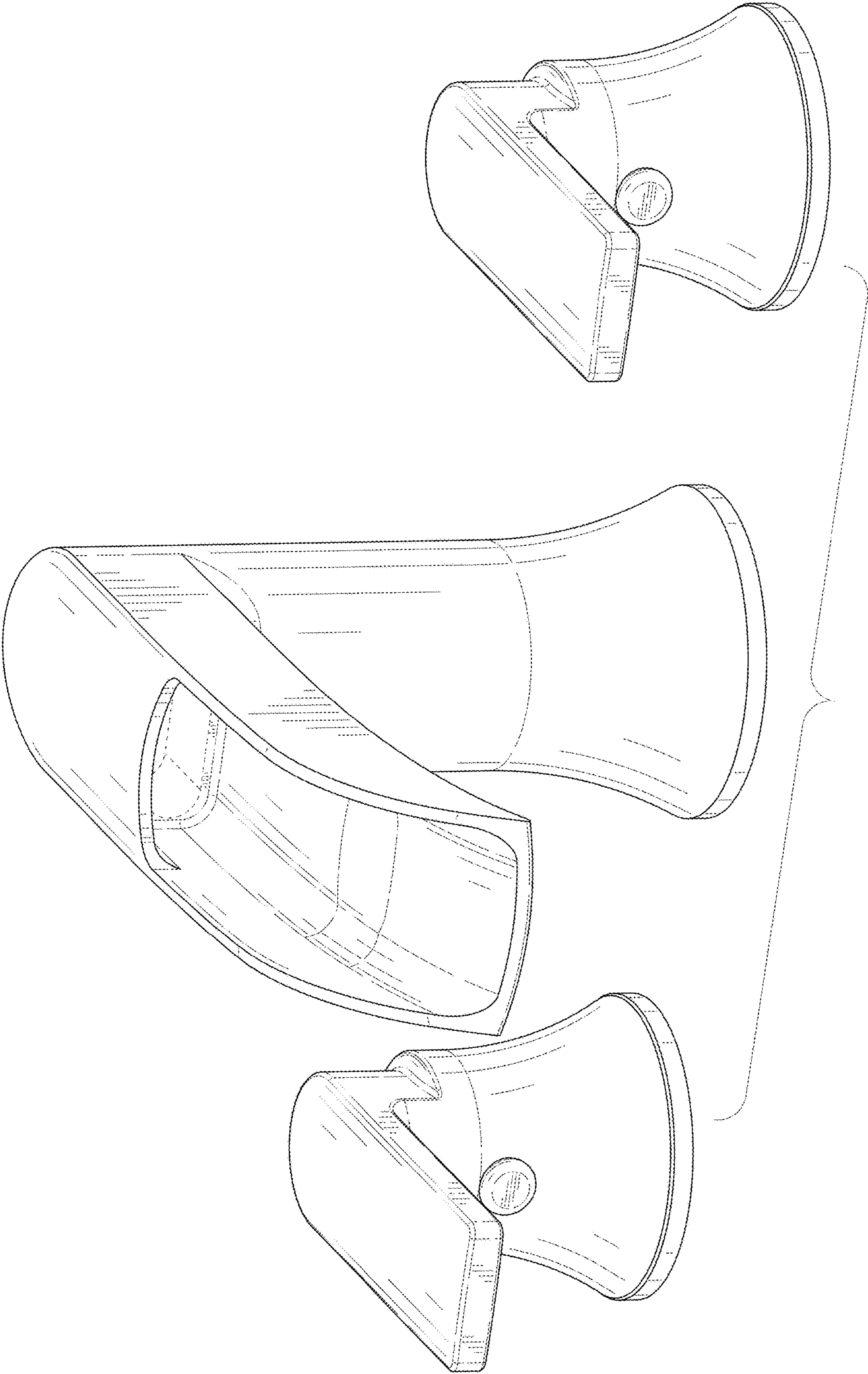

FIG. 1

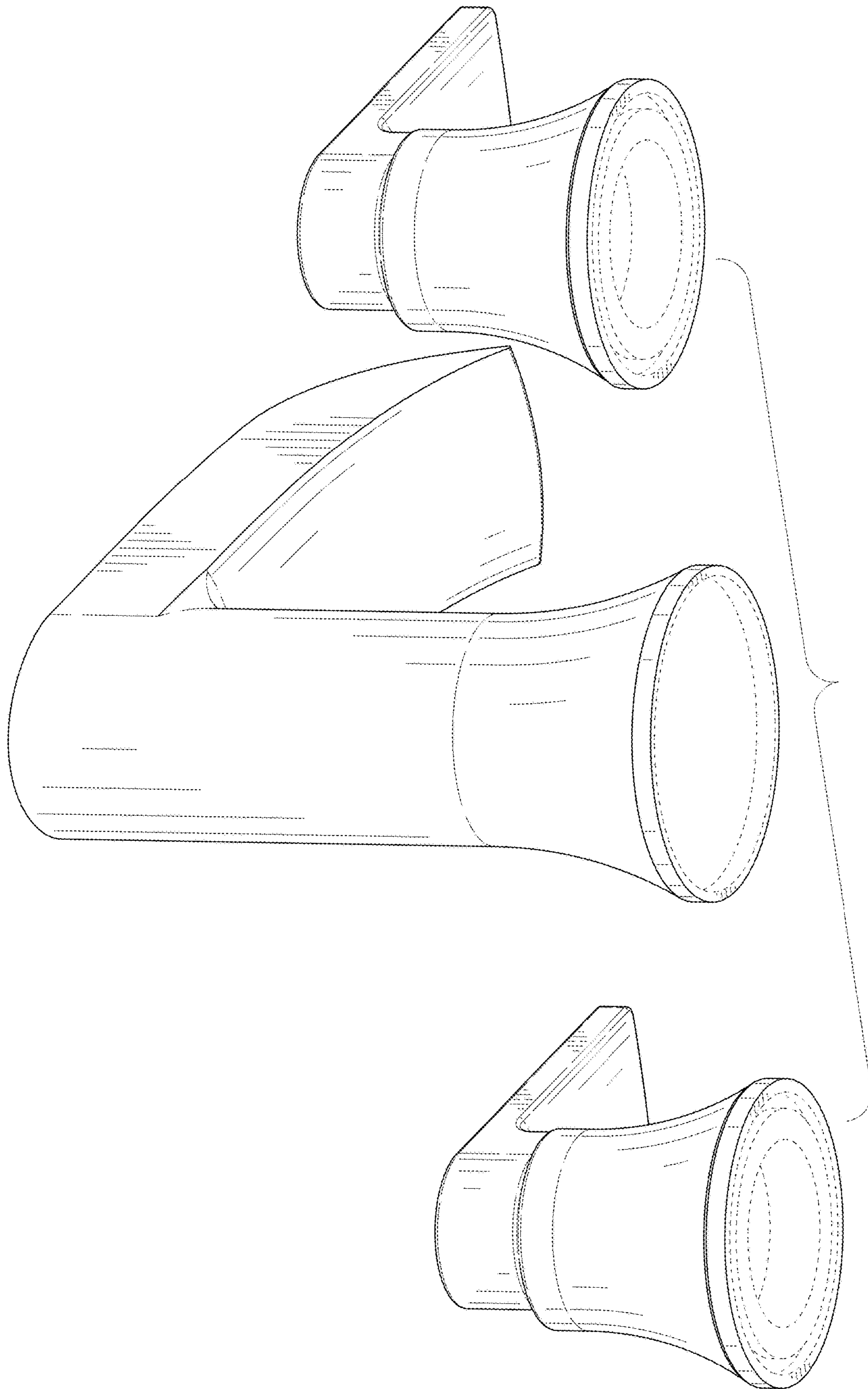

FIG. 2

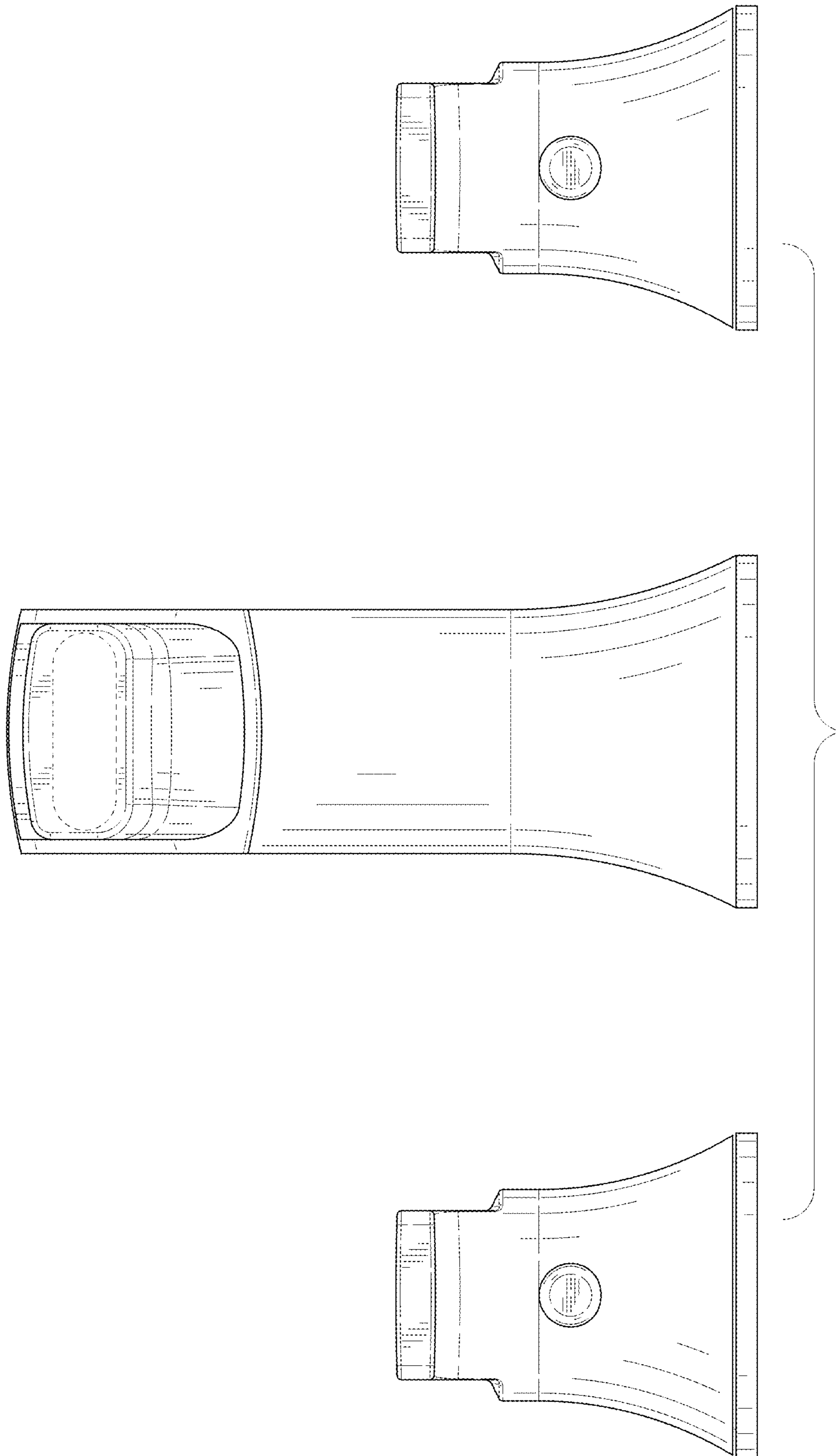

FIG. 3



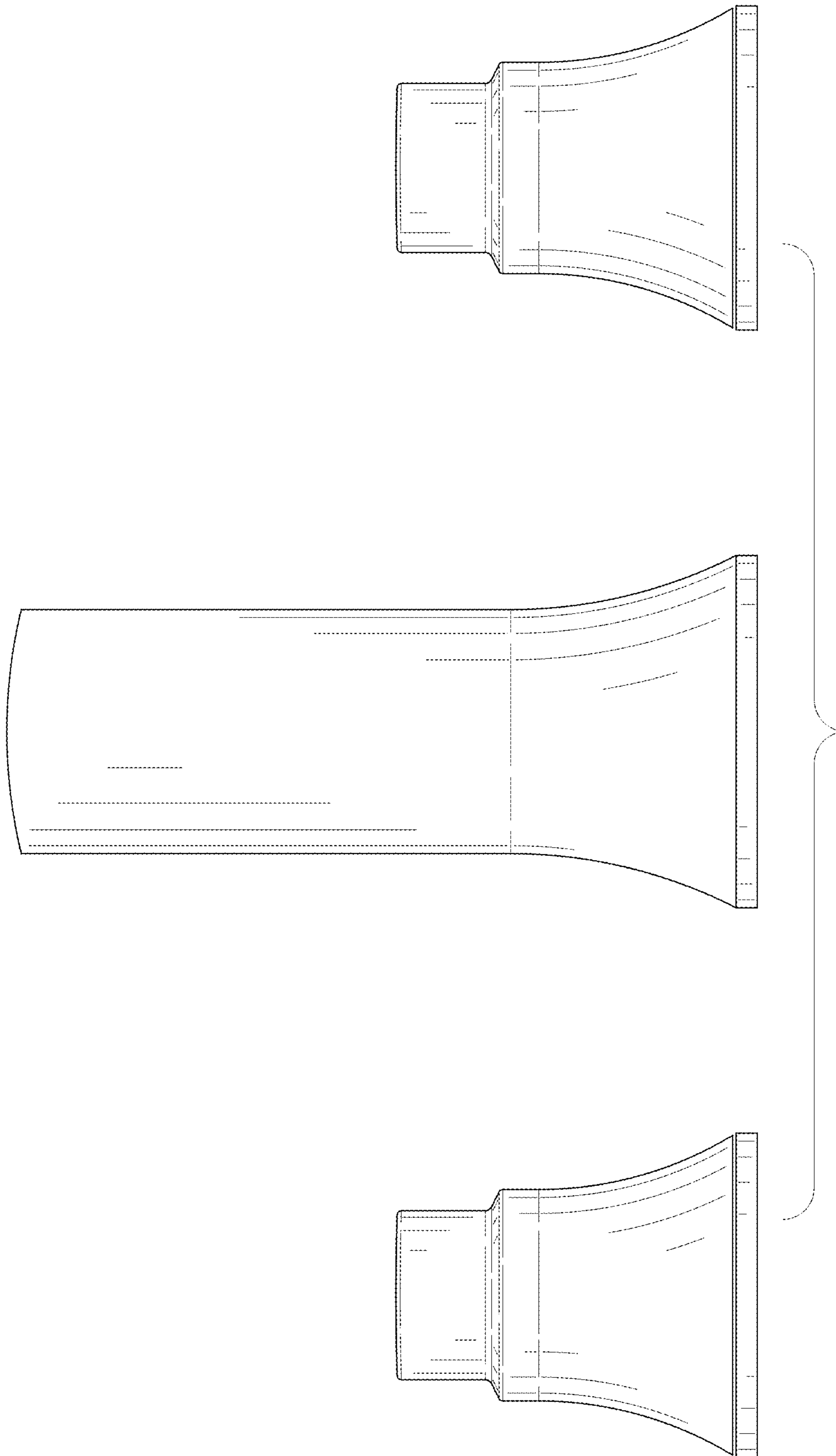

FIG. 4

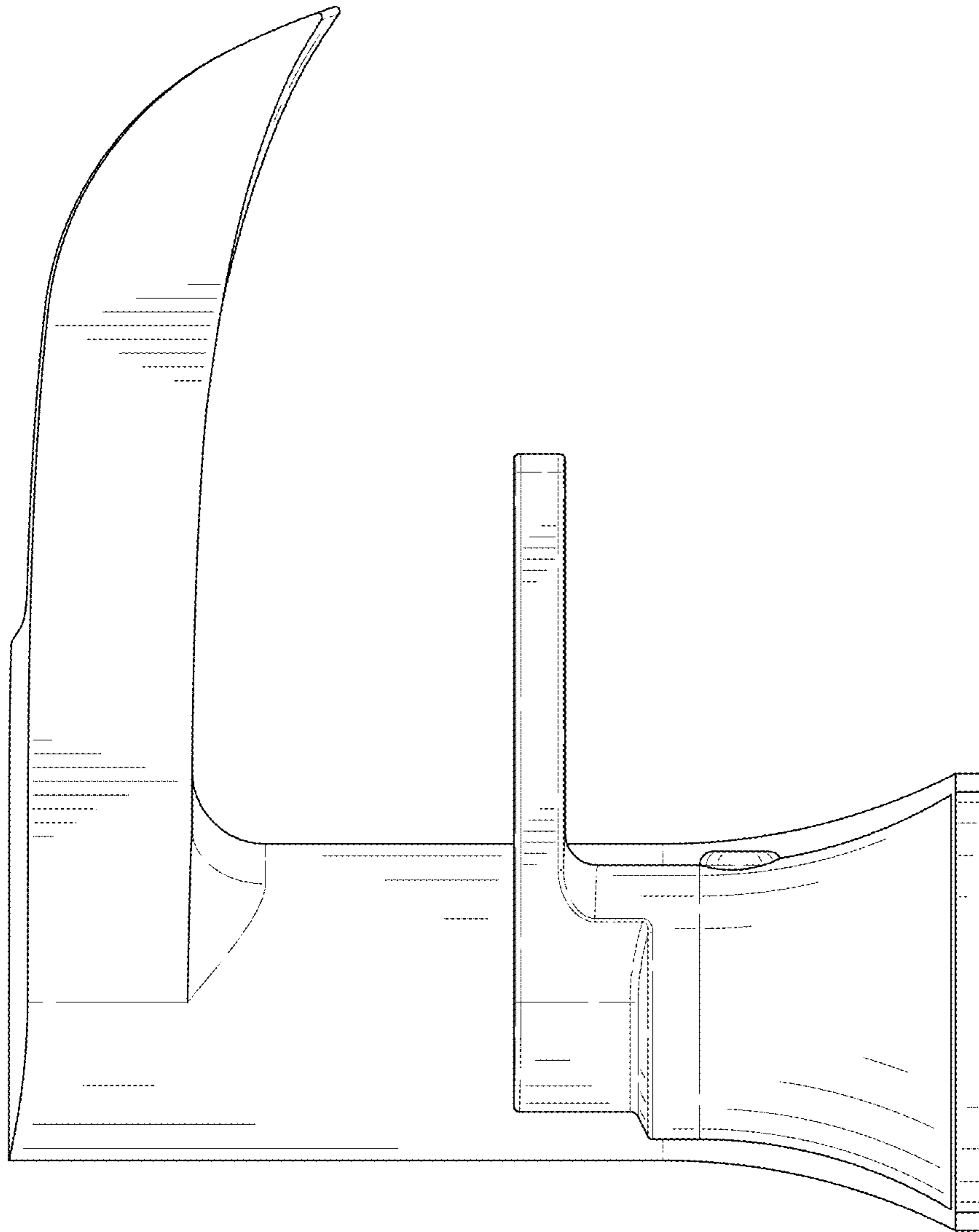

FIG. 5

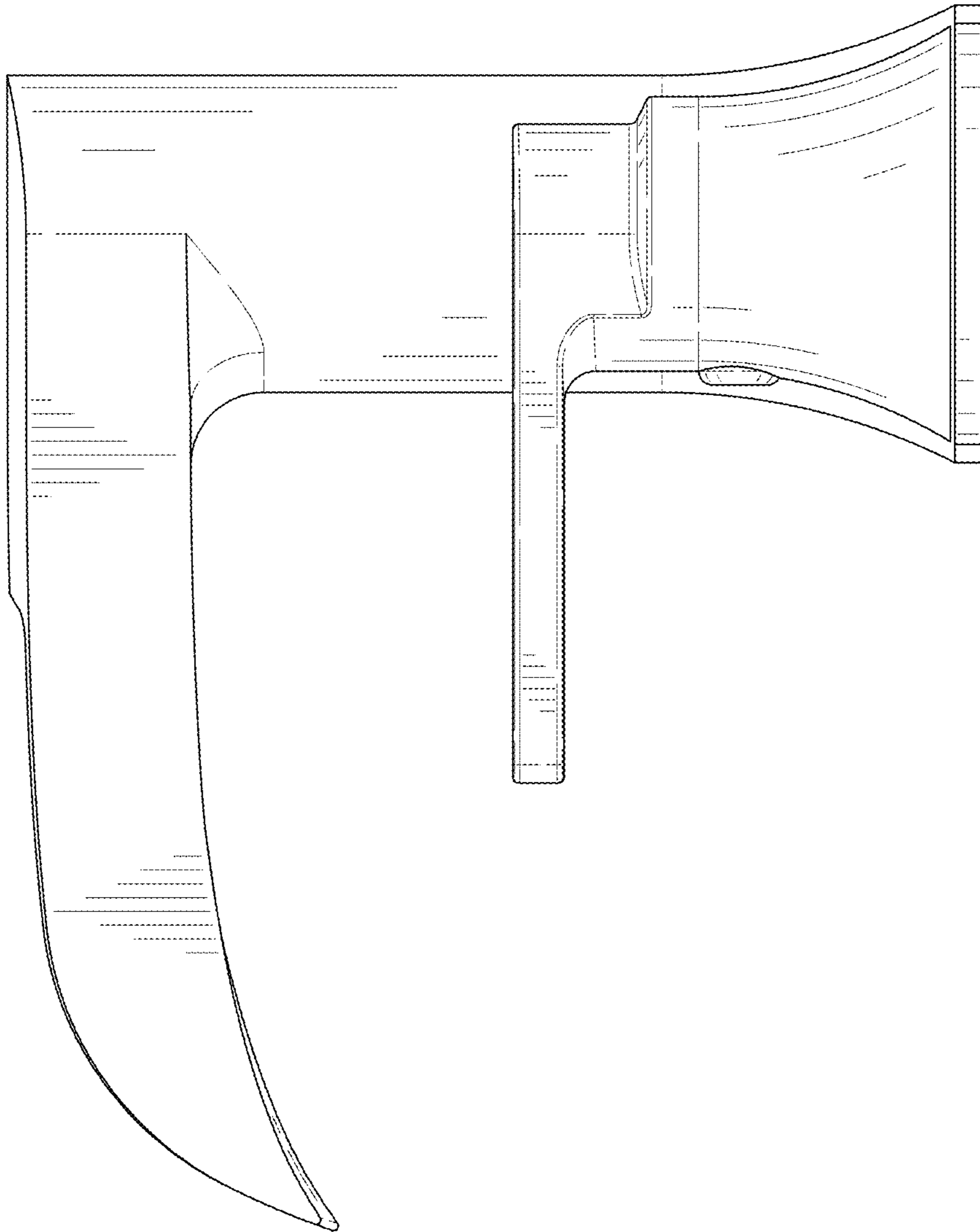

FIG. 6

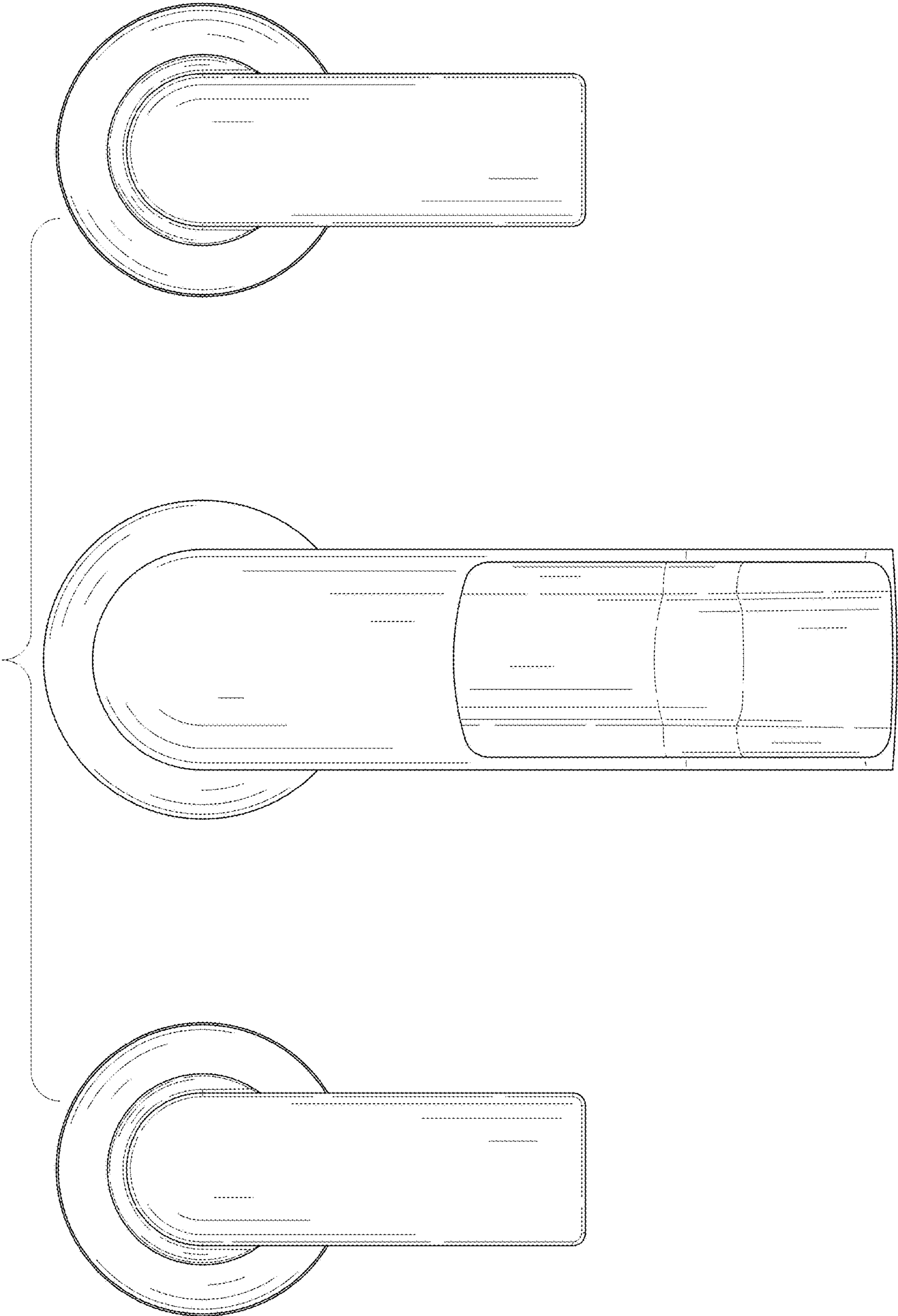

FIG. 7



