



US00D963798S

(12) **United States Design Patent**  
**Mahn et al.**

(10) **Patent No.:** **US D963,798 S**  
(45) **Date of Patent:** **\*\* Sep. 13, 2022**

(54) **TILTED POPPET VALVE FOR FUEL DISPENSING NOZZLE**

(71) Applicants: **Gerald A Mahn**, Arnold, MO (US);  
**Grenville G Sutcliffe**, Villa Ridge, MO (US)

(72) Inventors: **Gerald A Mahn**, Arnold, MO (US);  
**Grenville G Sutcliffe**, Villa Ridge, MO (US)

(73) Assignee: **Husky Corporation**, Pacific, MO (US)

(\*\*) Term: **15 Years**

(21) Appl. No.: **29/651,868**

(22) Filed: **May 21, 2019**

(51) **LOC (13) Cl.** ..... **23-01**

(52) **U.S. Cl.**  
USPC ..... **D23/233**

(58) **Field of Classification Search**  
USPC ..... D23/233, 234–237, 241–249, 213, 269;  
123/188.2, 41.69, 41.41, 41.76, 41.77,  
123/41.85, 188.1; 137/217, 15.18, 559,  
137/219, 625.34, 514, 493.4; D15/1, 5,  
D15/7; D24/155; D8/352  
CPC ..... F16K 15/026; F16K 11/044; F16K 1/36;  
F16K 1/42; F16K 1/38  
See application file for complete search history.

(56) **References Cited**

U.S. PATENT DOCUMENTS

1,850,063 A 2/1929 Pepper  
2,314,553 A 4/1941 Palm

2,622,435 A 9/1948 Lucas et al.  
3,062,247 A 12/1959 Botkin  
3,005,476 A 3/1960 Klaus  
3,988,001 A 12/1976 Kankaras  
4,523,700 A 6/1985 Bower et al.  
D570,375 S \* 6/2008 Hideki ..... D15/7  
D577,100 S \* 9/2008 Brown ..... D23/213  
D682,989 S \* 5/2013 Eagle ..... A61M 15/0086  
D23/233  
D715,404 S \* 10/2014 Clarke ..... D23/233  
D724,182 S \* 3/2015 Lu ..... D23/233  
D739,500 S \* 9/2015 Buermann ..... D23/249  
D739,919 S \* 9/2015 Alexander ..... D23/233  
D748,228 S \* 1/2016 Bayyouk ..... D23/269  
D756,747 S \* 5/2016 Wu ..... D8/352  
D787,029 S \* 5/2017 Bayyouk ..... D23/269  
D824,030 S \* 7/2018 Holley ..... D24/155

\* cited by examiner

*Primary Examiner* — Gino Colan

(74) *Attorney, Agent, or Firm* — Paul M. Denk

(57) **CLAIM**

The ornamental design for a tilted poppet valve for fuel dispensing nozzle, as shown and described.

**DESCRIPTION**

FIG. 1 is an isometric view of a tilted poppet valve for fuel dispensing nozzle of showing our new design; FIG. 2 is a front elevation view thereof; FIG. 3 is a rear elevation view thereof; FIG. 4 is a left side elevation view thereof; FIG. 5 is a right side elevation view thereof; FIG. 6 is a top plan view thereof; and, FIG. 7 is a bottom plan view thereof.

**1 Claim, 1 Drawing Sheet**

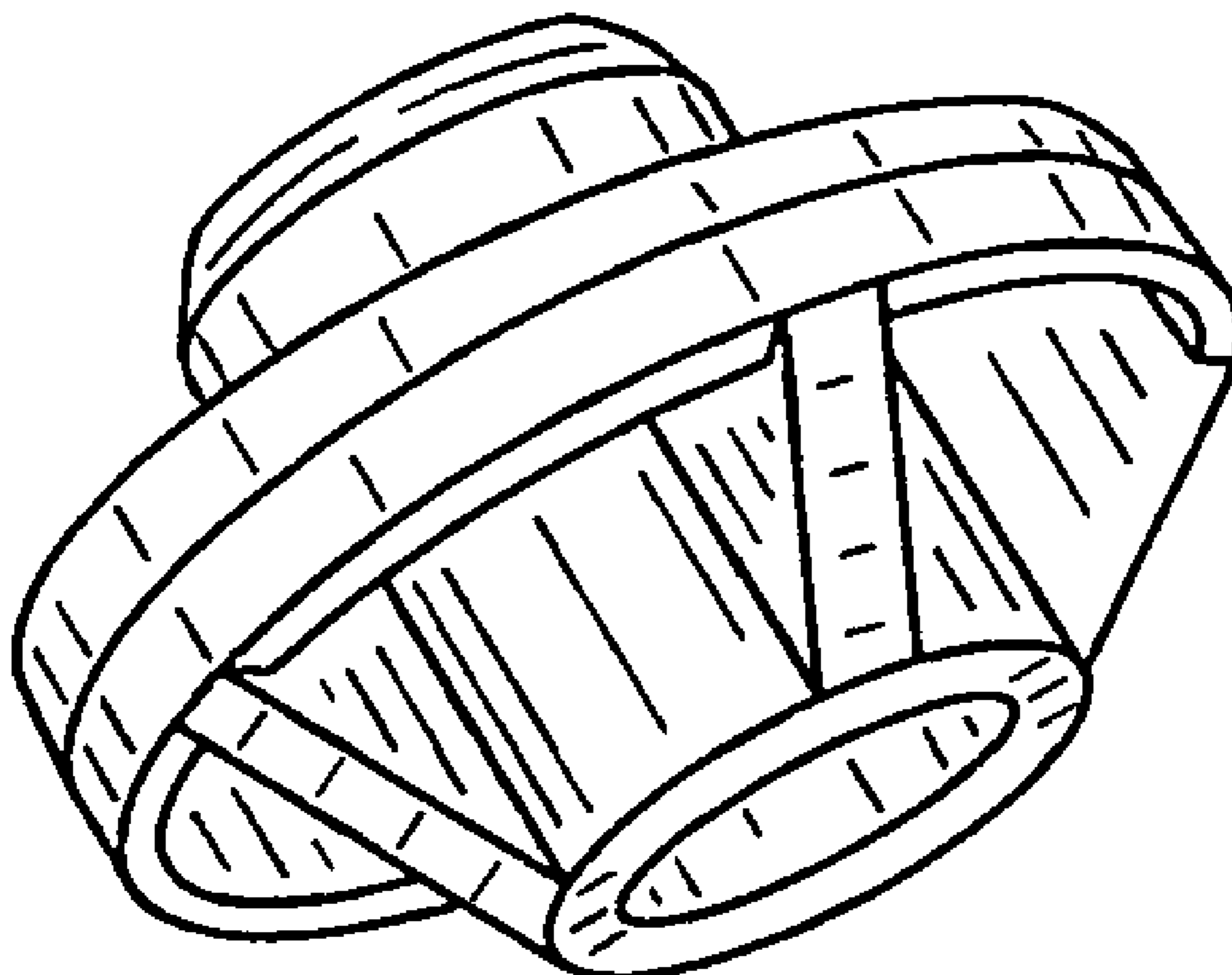

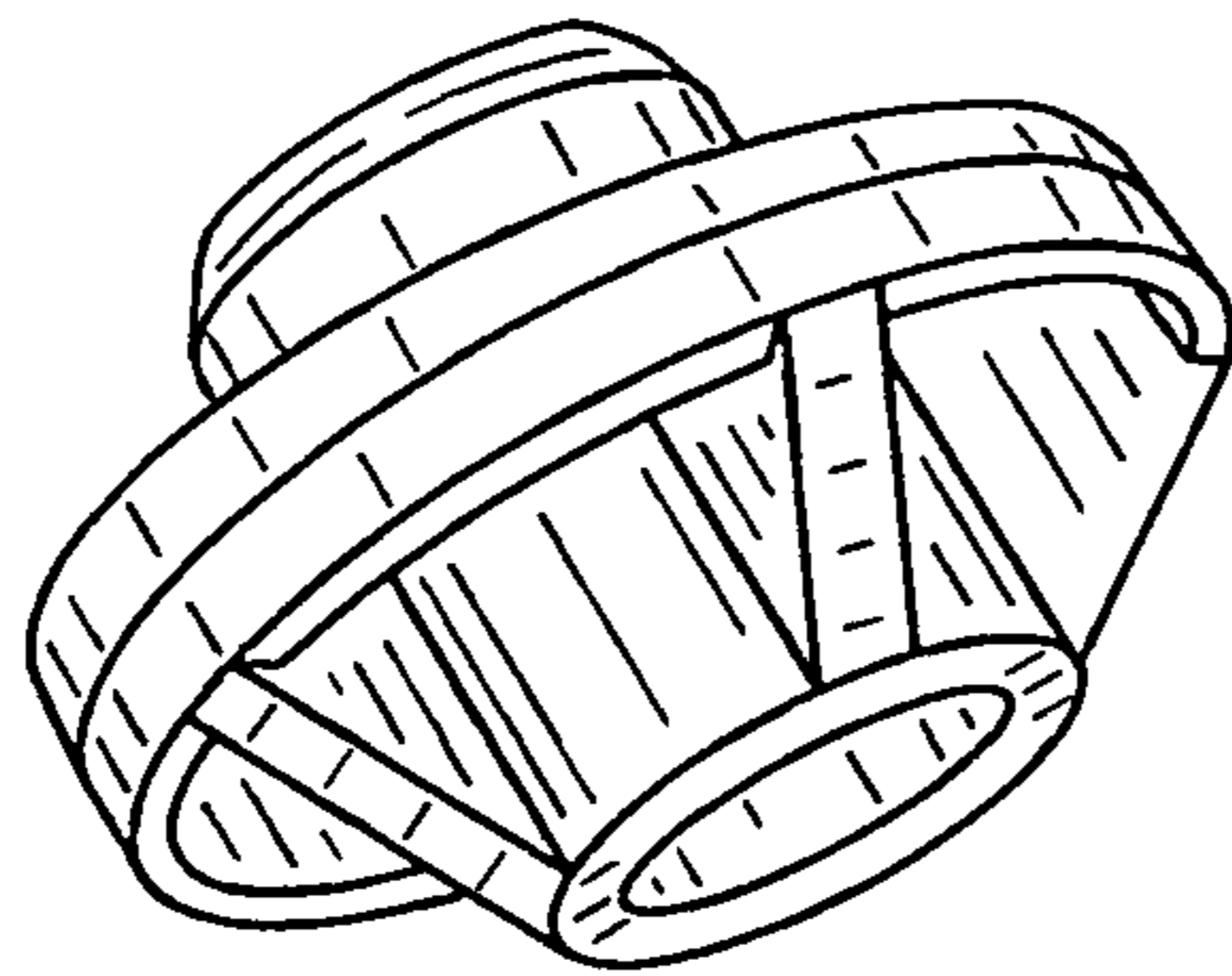

FIG. 1

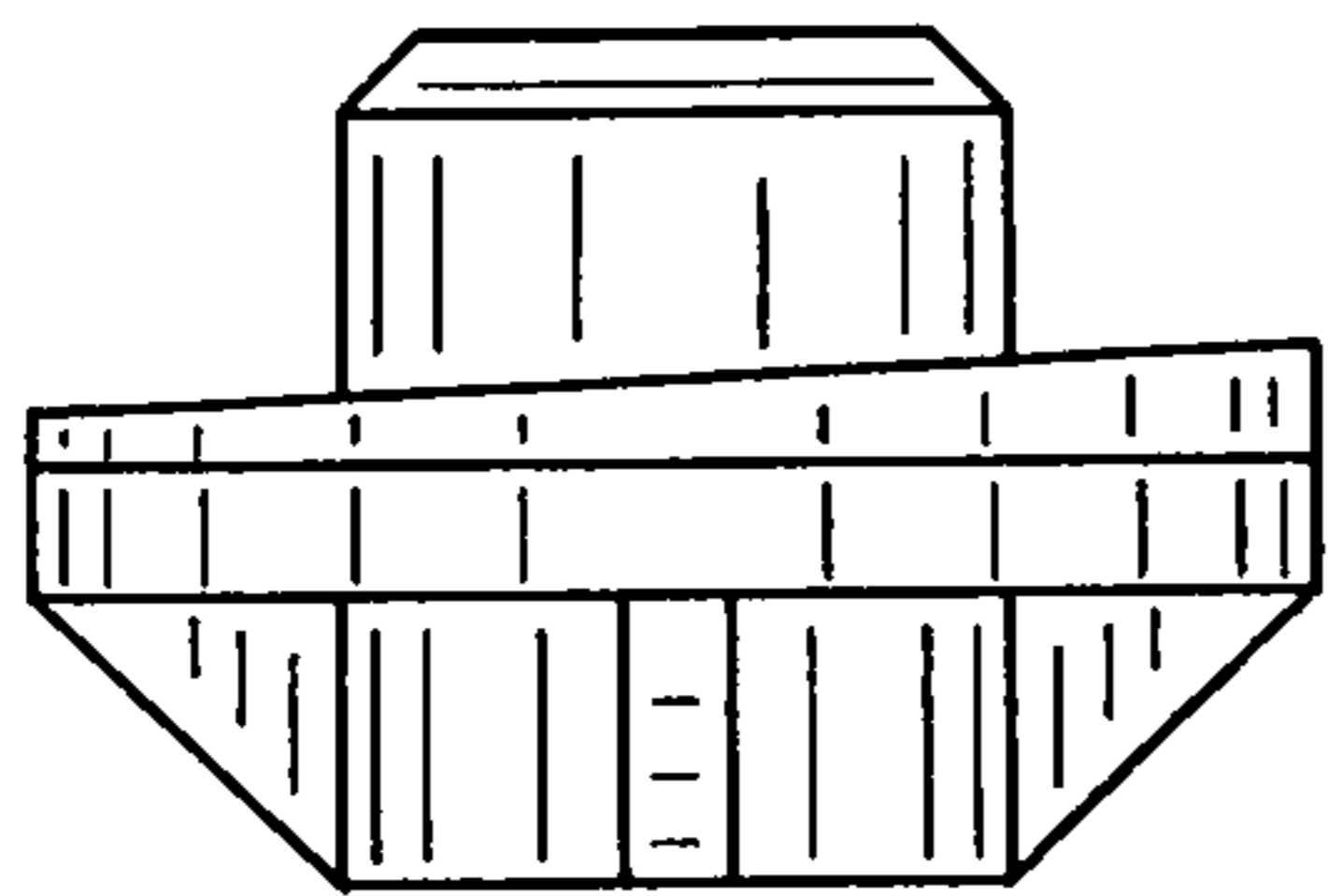

FIG. 2

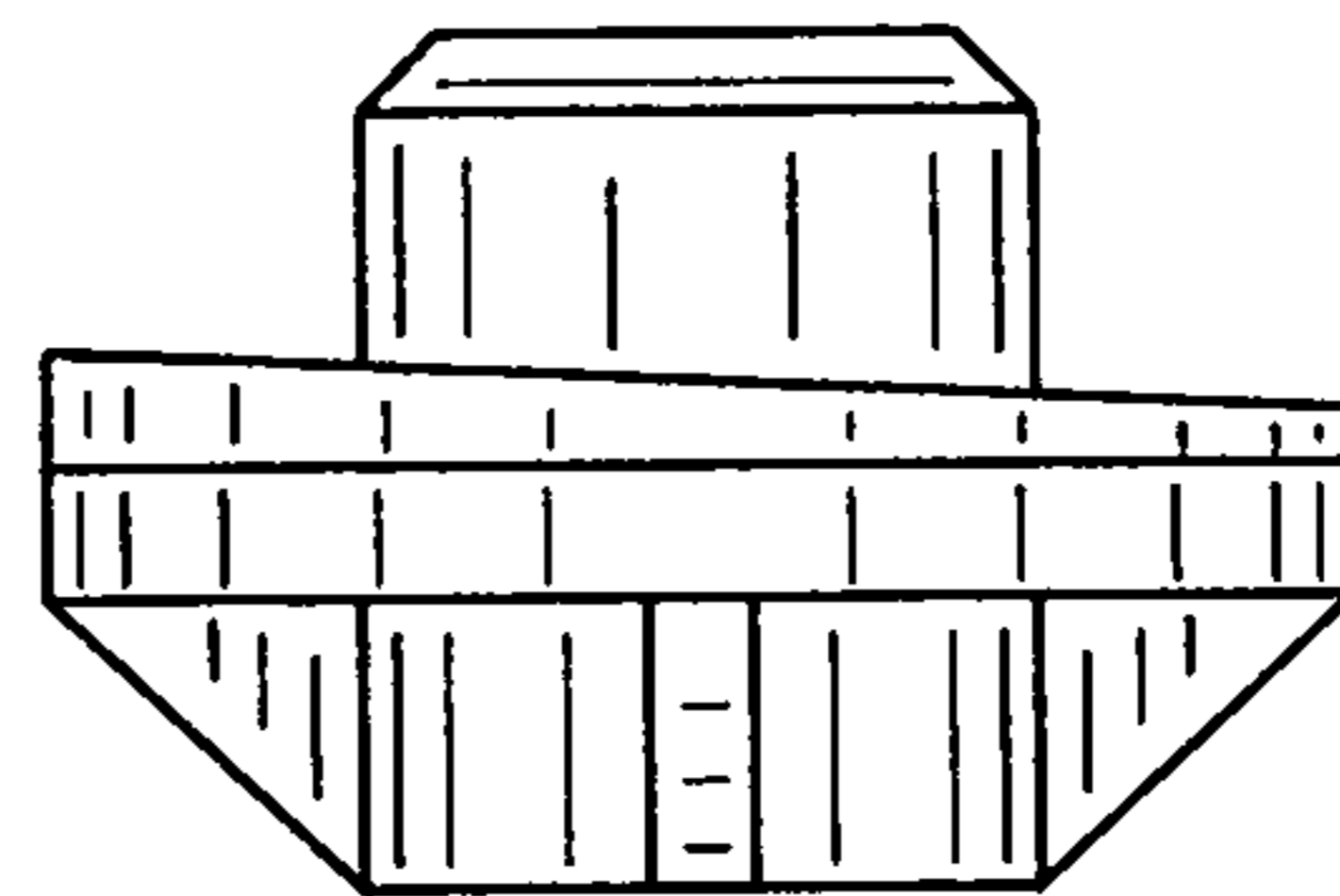

FIG. 3

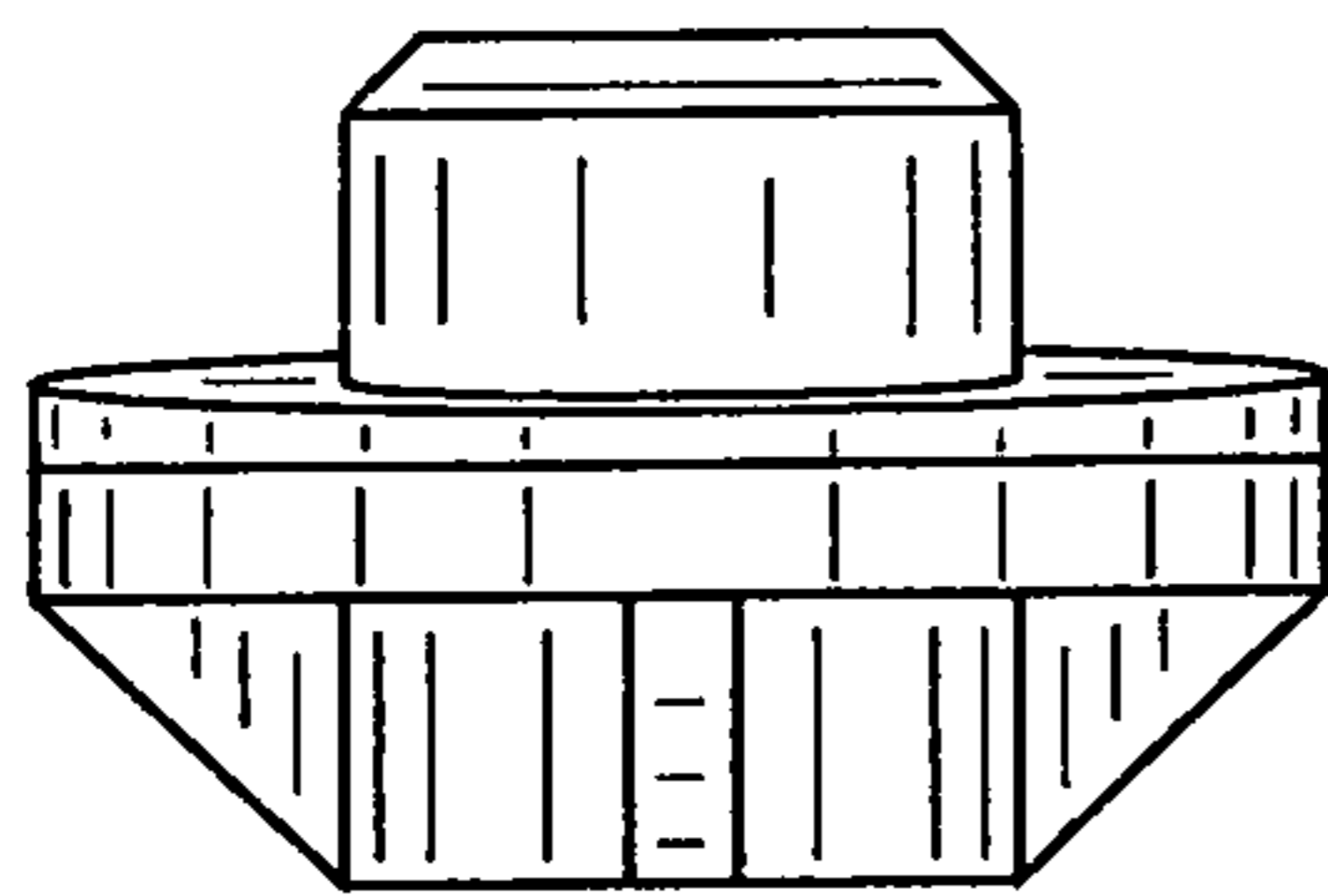

FIG. 4

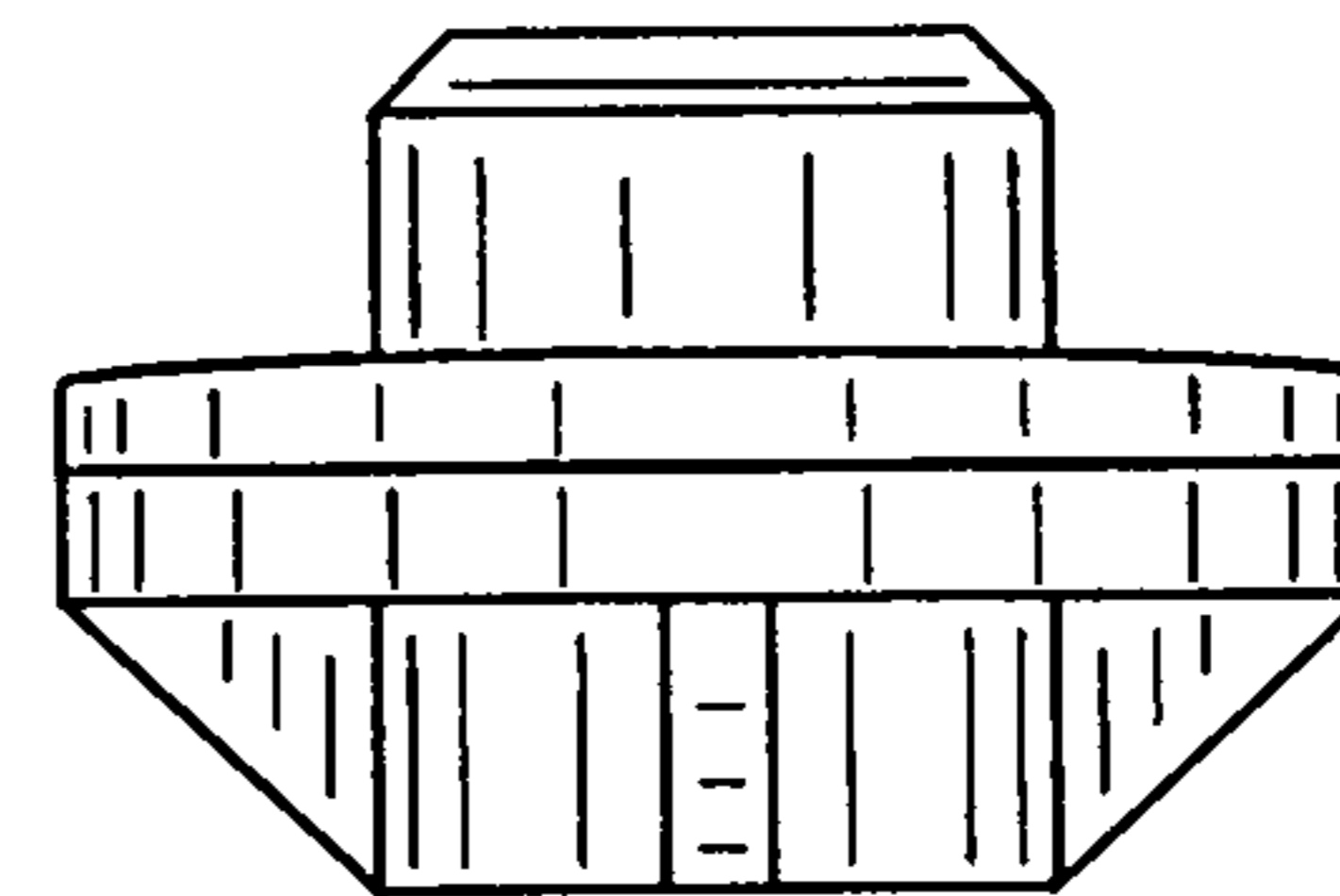

FIG. 5

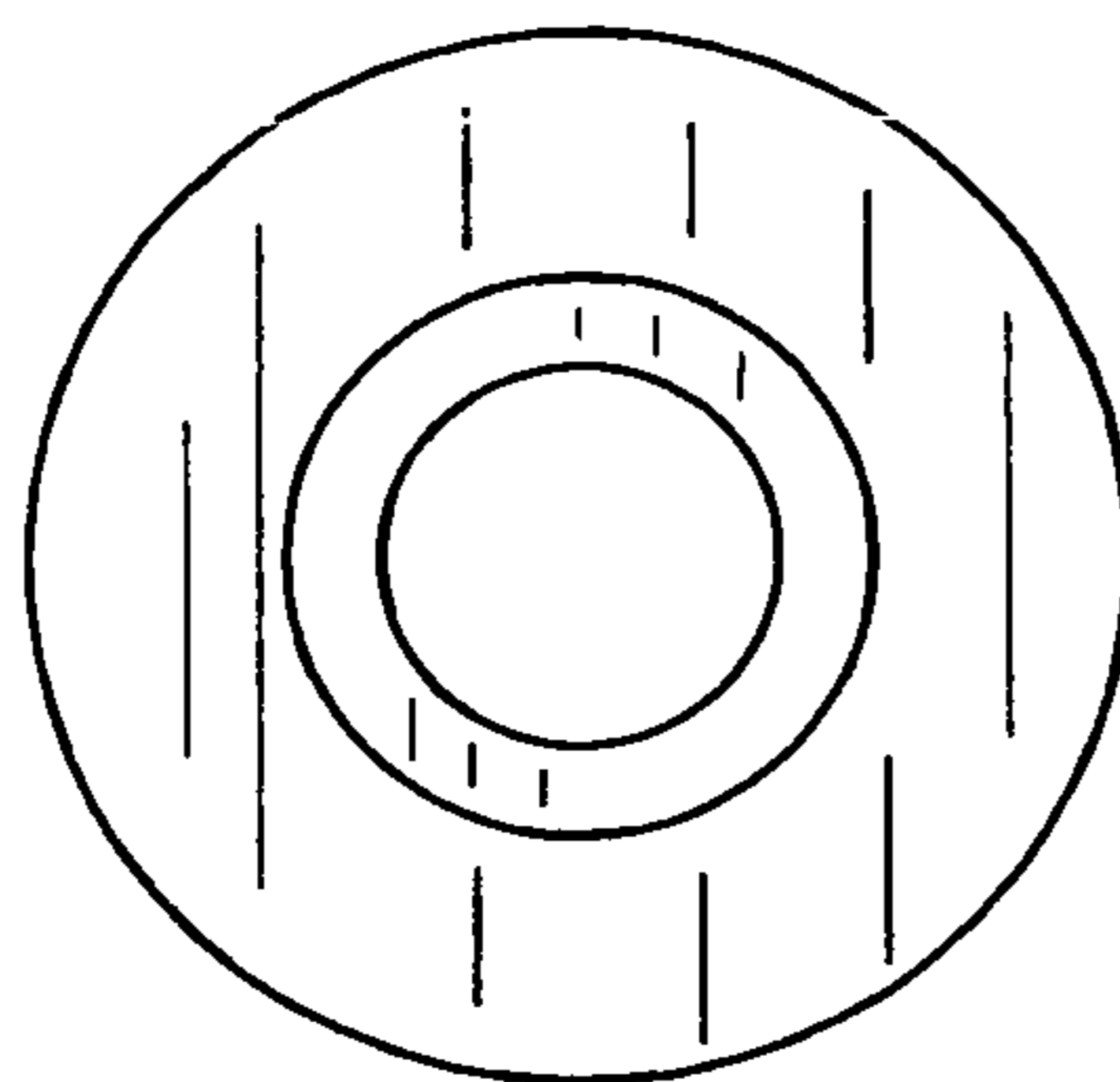

FIG. 6

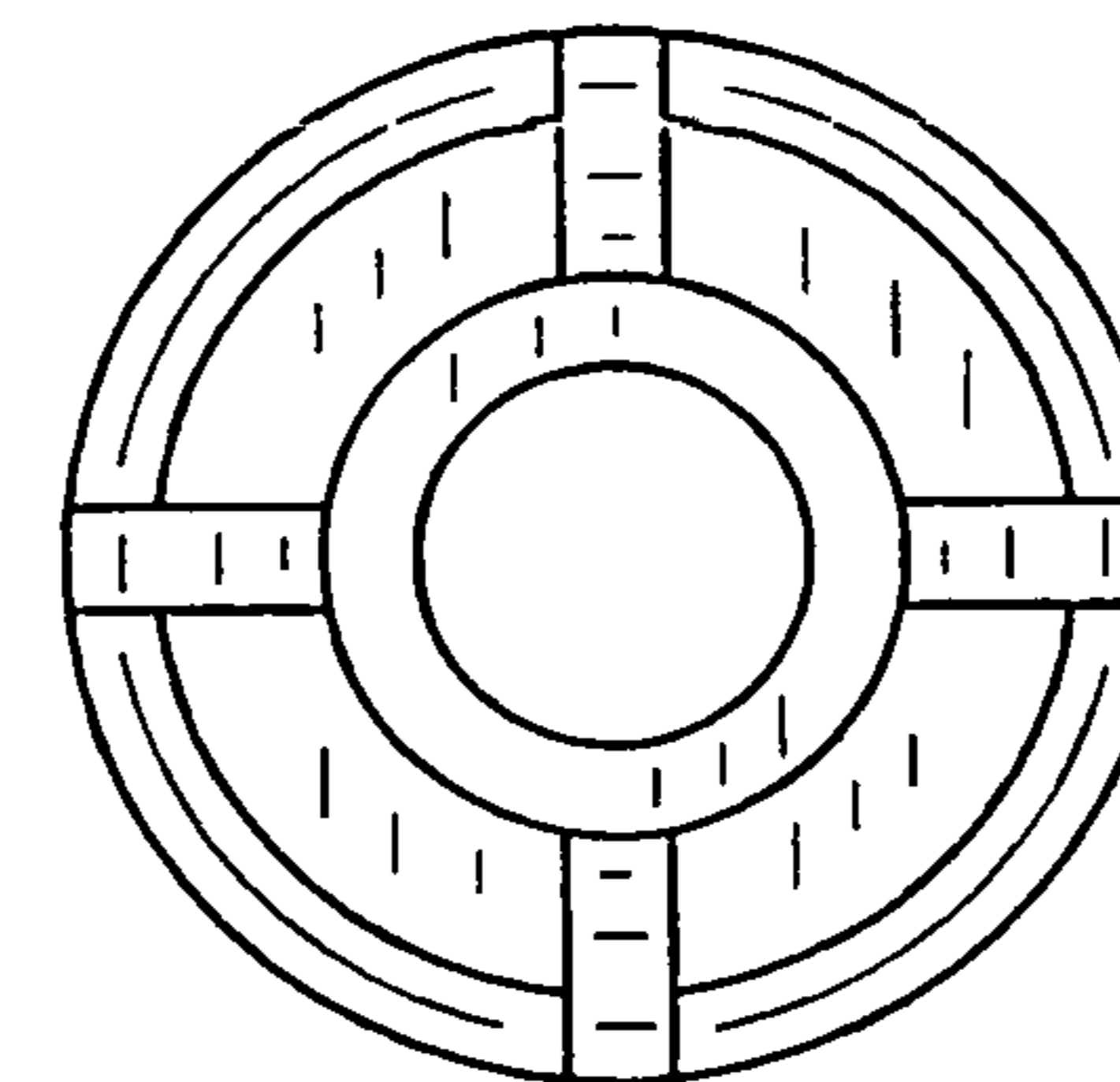

FIG. 7