

US00D963622S

(12) **United States Design Patent** (10) **Patent No.:** **US D963,622 S**
Lange (45) **Date of Patent:** **** Sep. 13, 2022**

(54) **TV ANTENNA**

FOREIGN PATENT DOCUMENTS

(71) Applicant: **Jasco Products Company LLC**,
Oklahoma City, OK (US)

CN	305611013	*	2/2020
CN	305655066	*	3/2020
CN	306149741	*	11/2020
CN	307101047	*	2/2022
JP	D1599213	*	3/2021

(72) Inventor: **Ryan Neal Lange**, Edmond, OK (US)

(73) Assignee: **Jasco Products Company, LLC**,
Oklahoma City, OK (US)

OTHER PUBLICATIONS

(**) Term: **15 Years**

Phillips, HD Fabric Contour Series Indoor . . . Antenna, available at target.com, oldest review date 2018, site visited May 16, 2022, Available at URL: https://www.target.com/p/philips-hd-fabric-contour-series-indoor-passive-antenna-gray/-/A-53272022?ref=tgt_adv_XS000000&AFID=google_pla_df_free_local&C (Year: 2018).*

(21) Appl. No.: **29/709,300**

(22) Filed: **Oct. 13, 2019**

(Continued)

(51) **LOC (13) Cl.** **14-03**

(52) **U.S. Cl.**
USPC **D14/230; D14/214**

(58) **Field of Classification Search**
USPC D14/230, 204, 207, 209–216, 231–238,
D14/299, 358; D12/42, 43
CPC H01Q 7/10; H01Q 13/10; H01Q 9/285;
H01Q 19/30; H01Q 19/12; H01Q 1/38;
H01Q 1/36; H04B 1/047; H04B 1/034;
H05K 11/00

Primary Examiner — Daniel J Domino

Assistant Examiner — Samina Vieth

(74) *Attorney, Agent, or Firm* — William Popejoy

See application file for complete search history.

(57) **CLAIM**

The ornamental design for a TV antenna, as shown and described.

(56) **References Cited**

DESCRIPTION

U.S. PATENT DOCUMENTS

D433,227 S	*	11/2000	Evans	D3/218
D533,544 S	*	12/2006	Lai	D14/230
D556,736 S	*	12/2007	Kim	D14/214
D565,539 S	*	4/2008	Kim	D14/211
D589,935 S	*	4/2009	Kim	D14/214
D711,852 S	*	8/2014	Mackiewicz	D14/214
D734,737 S	*	7/2015	Ahn	D14/209.1
D751,535 S	*	3/2016	Poddaturi	D14/230
D759,630 S	*	6/2016	Huang	D14/215
D798,841 S	*	10/2017	Park	D14/218
D818,977 S	*	5/2018	Kim	D14/126
D827,610 S	*	9/2018	Kim	D14/214
D870,083 S	*	12/2019	Zhao	D14/230
D883,953 S	*	5/2020	Chong	D14/214
D886,805 S	*	6/2020	Yang	D14/230

FIG. 1 is a front perspective view of a TV antenna showing my new design;
FIG. 2 is a rear perspective view thereof;
FIG. 3 is a front elevational view thereof;
FIG. 4 is a rear elevational view thereof;
FIG. 5 is a top plan view thereof;
FIG. 6 is a left side elevational view thereof;
FIG. 7 is a right side elevational view thereof; and,
FIG. 8 is a bottom plan view thereof.

The structural-features depicted by broken lines have been shown for the purpose of illustrating portions of a TV antenna that form no part of the claimed design.

(Continued)

1 Claim, 3 Drawing Sheets

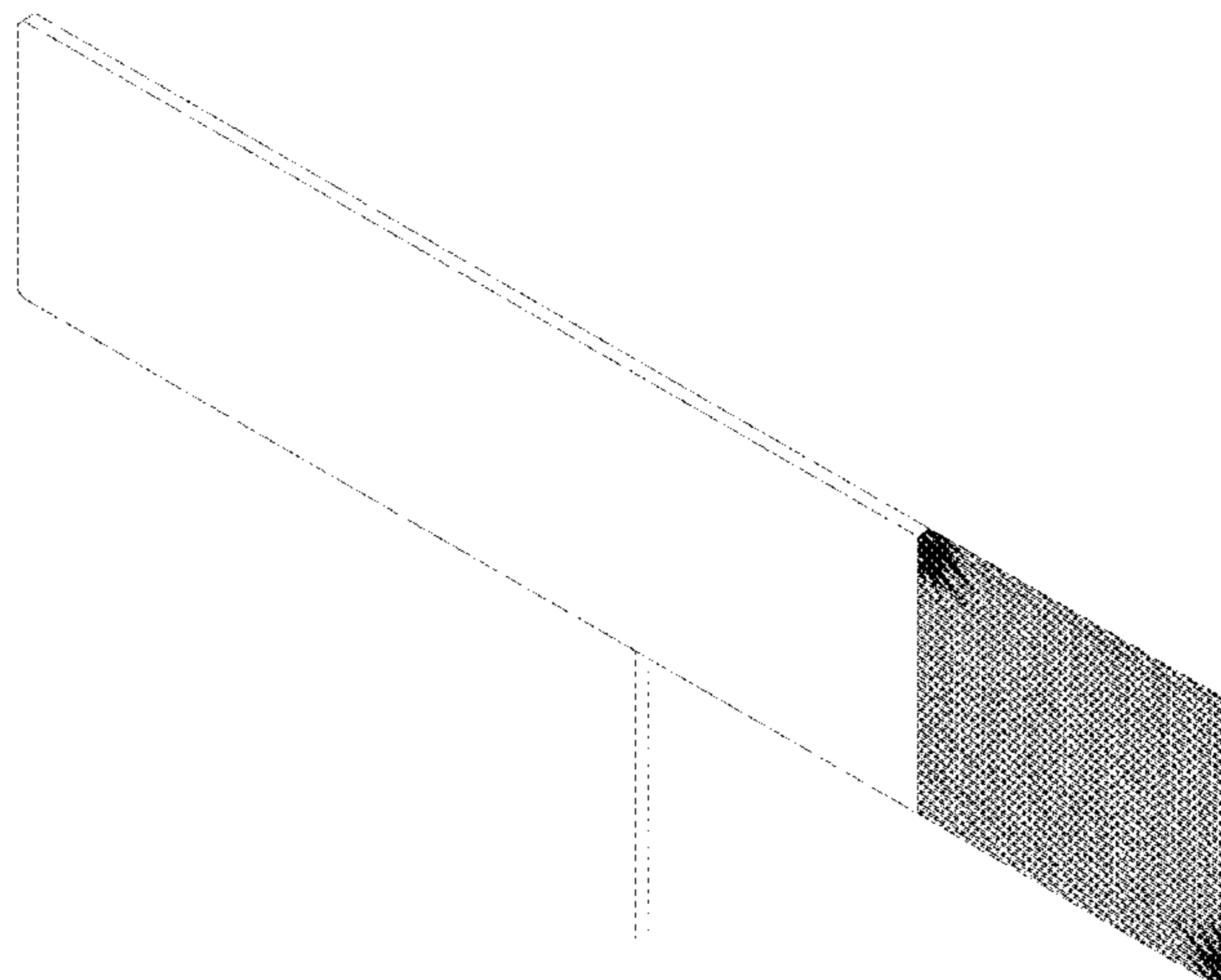

(56)

References Cited

U.S. PATENT DOCUMENTS

D897,994 S * 10/2020 Bowers D14/218
D907,031 S * 1/2021 Fitzgerald D14/299
D922,979 S * 6/2021 Kim D14/210
D942,419 S * 2/2022 Park D14/214
D942,965 S * 2/2022 Kim D14/215

OTHER PUBLICATIONS

Best Buy Essentials, Compact Ultra-Thin . . . HDTV Antenna . . . , available at bestbuy.com, oldest review date 2021, site visited May 16, 2022, Available at URL: <https://www.bestbuy.com/site/best-buy-essentials-compact-ultra-thin-indoor-hdtv-antenna-black-white/6454217.p?skuId=6454217&ref=NS&loc=101&extSt> (Year: 2021).*

Onn, Designer 4k Ultra Hd Tv Antenna . . . , available at walmart.com, oldest review date Jul. 15, 2020, site visited May 16, 2022, Available at URL: <https://www.walmart.com/reviews/product/148343807?sort=submission-asc> (Year: 2020).*

Antop, Omni Bar . . . HDTV Antenna . . . , available at homedepot.com, oldest review date Sep. 23, 2020, site visited May 16, 2022, Available at URL: <https://www.homedepot.com/p/Antop-Omni-Bar-Indoor-Outdoor-Smartpass-Amplified-HDTV-Antenna-in-Indigo-AT-420B-Indigo/320140369?source=shoppingads&locale=en-US> (Year: 2020).*

Antop Antenna, All in One indoor TV Antenna . . . , available at amazon.com, date first available Oct. 2, 2019, site visited May 16, 2022, Available at URL: https://www.amazon.com/dp/B07XZ6RG34/ref=cm_sw_em_r_mt_dp_FBKCKWFN4VP1NS1VKFEX (Year: 2019).*

* cited by examiner

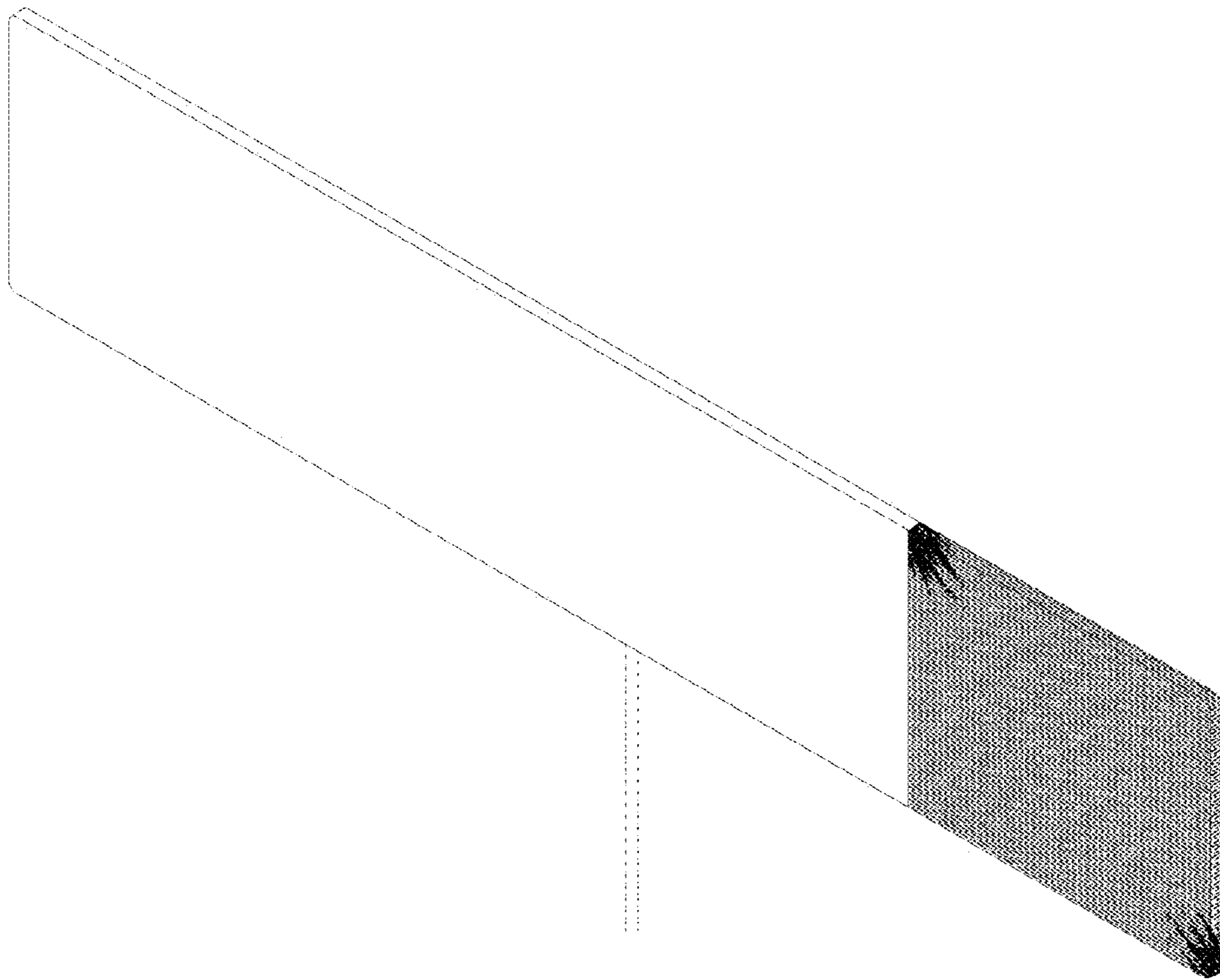

FIG. 1

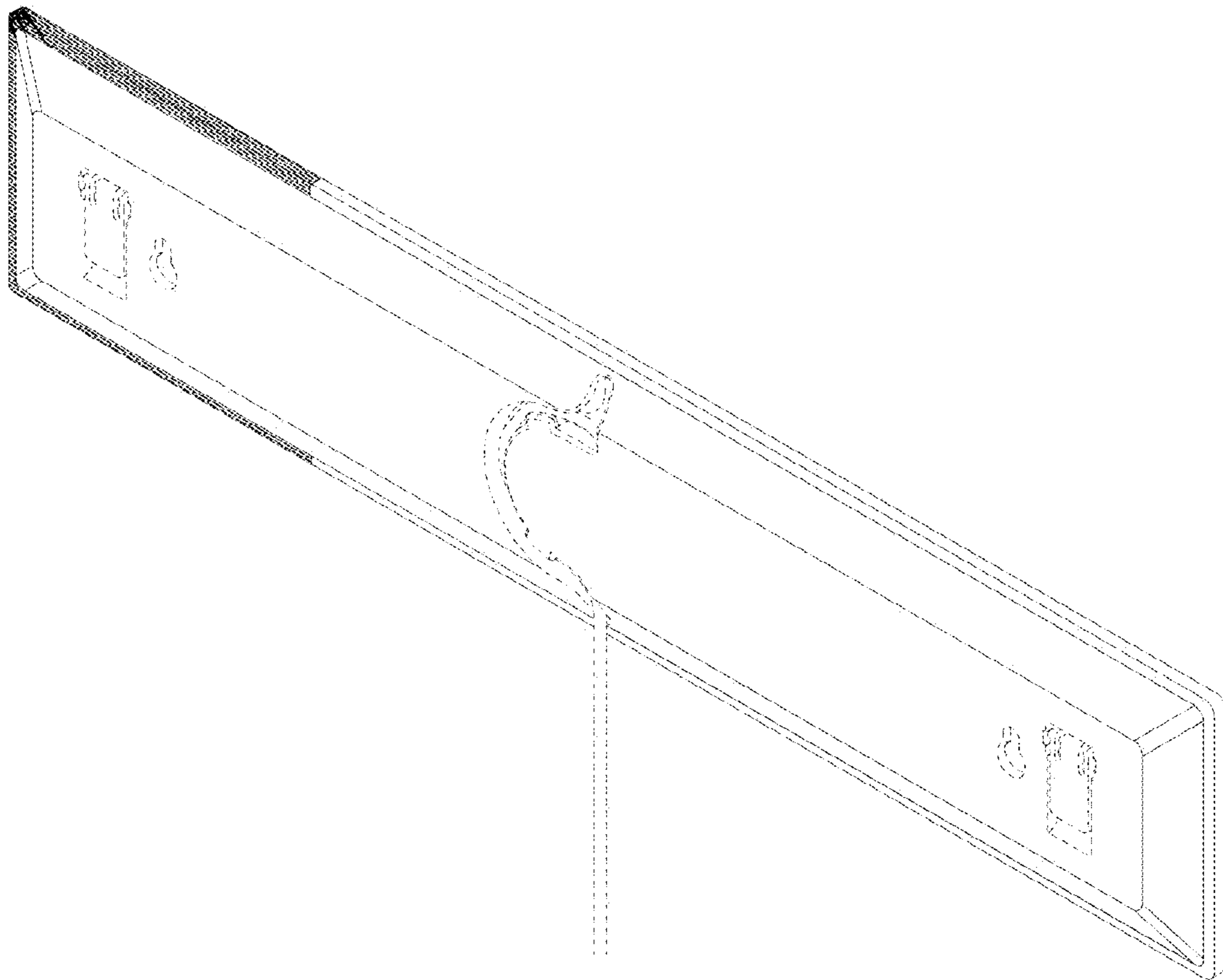

FIG. 2



FIG. 3

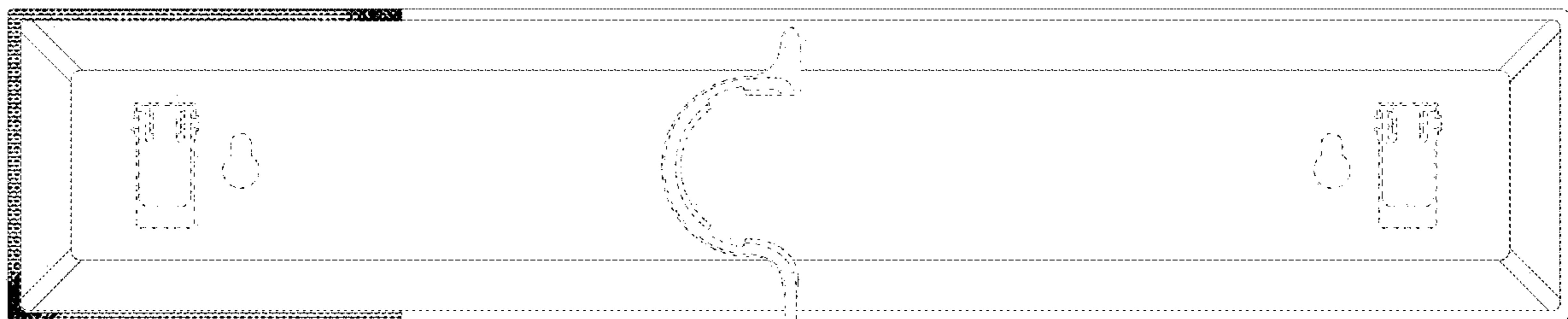

FIG. 4

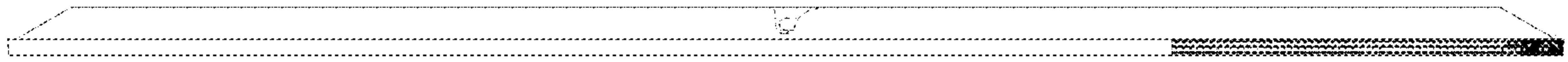

FIG. 5

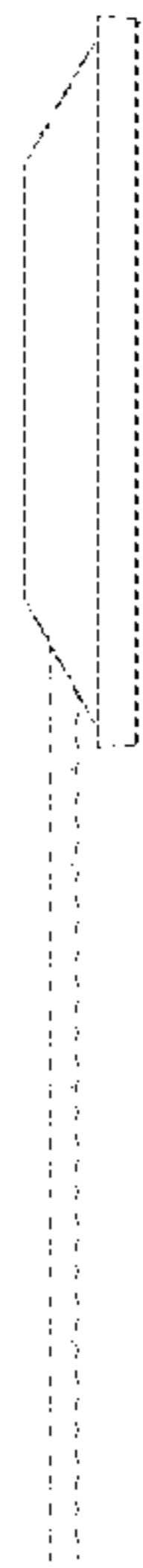

FIG. 6



FIG. 7

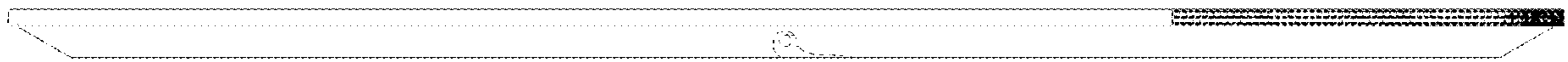

FIG. 8