



US00D963609S

(12) **United States Design Patent**  
**Jing**

(10) **Patent No.:** **US D963,609 S**

(45) **Date of Patent:** **\*\* Sep. 13, 2022**

(54) **VIDEO GAME CONTROLLER**

(71) Applicant: **Shen Jing**, Beijing (CN)

(72) Inventor: **Shen Jing**, Beijing (CN)

(73) Assignee: **Shen Jing**, Beijing (CN)

(\*\*) Term: **15 Years**

(21) Appl. No.: **29/697,885**

(22) Filed: **Jul. 11, 2019**

(30) **Foreign Application Priority Data**

Jun. 6, 2019 (CN) ..... 201930292306.2

(51) **LOC (13) Cl.** ..... **14-03**

(52) **U.S. Cl.**  
USPC ..... **D14/218**

(58) **Field of Classification Search**  
USPC ..... D14/218, 230; D21/331, 332, 333, 329;  
D13/168

(Continued)

(56) **References Cited**

**U.S. PATENT DOCUMENTS**

D300,220 S \* 3/1989 Schremmer ..... D14/218  
D307,921 S \* 5/1990 Barr ..... D14/413

(Continued)

**FOREIGN PATENT DOCUMENTS**

CN 304980834 \* 1/2019  
EM 000153614-0001 \* 8/2004  
EM 008086854-0001 \* 9/2020

**OTHER PUBLICATIONS**

PXN Store, PXN 0082 Joystick . . . available at amazon.com, date first available Nov. 11, 2019, site visited 02/22/222, Available at URL: [https://www.amazon.com/PXN-0082-Fighting-Joystick-Controller/dp/B081CBD1SC/ref=sr\\_1\\_5?crid=1JFAER3LB75LW&keywords=joystick+controller&qid=1645553986&sprefix=joystick+co%20\(Year: 2019\).\\*](https://www.amazon.com/PXN-0082-Fighting-Joystick-Controller/dp/B081CBD1SC/ref=sr_1_5?crid=1JFAER3LB75LW&keywords=joystick+controller&qid=1645553986&sprefix=joystick+co%20(Year: 2019).*)

(Continued)

*Primary Examiner* — Daniel J Domino

*Assistant Examiner* — Samina Vieth

(74) *Attorney, Agent, or Firm* — Fenwick & West LLP

(57) **CLAIM**

The ornamental design for a video game controller, as shown and described.

**DESCRIPTION**

FIG. 1 is a top view of a video game controller;  
FIG. 2 is a bottom view of the video game controller;  
FIG. 3 is a left view of the video game controller;  
FIG. 4 is a right view of the video game controller;  
FIG. 5 is a back view of the video game controller;  
FIG. 6 is a front view of the video game controller;  
FIG. 7 is a perspective view of the video game controller;  
FIG. 8 is a top view of a first assembly of the video game controller;  
FIG. 9 is a bottom view of the first assembly of the video game controller;  
FIG. 10 is a left view of the first assembly of the video game controller;  
FIG. 11 is a right view of the first assembly of the video game controller;  
FIG. 12 is a back view of the first assembly of the video game controller;  
FIG. 13 is a front view of the first assembly of the video game controller;  
FIG. 14 is a perspective view of the first assembly of the video game controller;  
FIG. 15 is a top view of a second assembly of the video game controller;  
FIG. 16 is a bottom view of the second assembly of the video game controller;  
FIG. 17 is a left view of the second assembly of the video game controller;  
FIG. 18 is a right view of the second assembly of the video game controller;  
FIG. 19 is a back view of the second assembly of the video game controller;

(Continued)

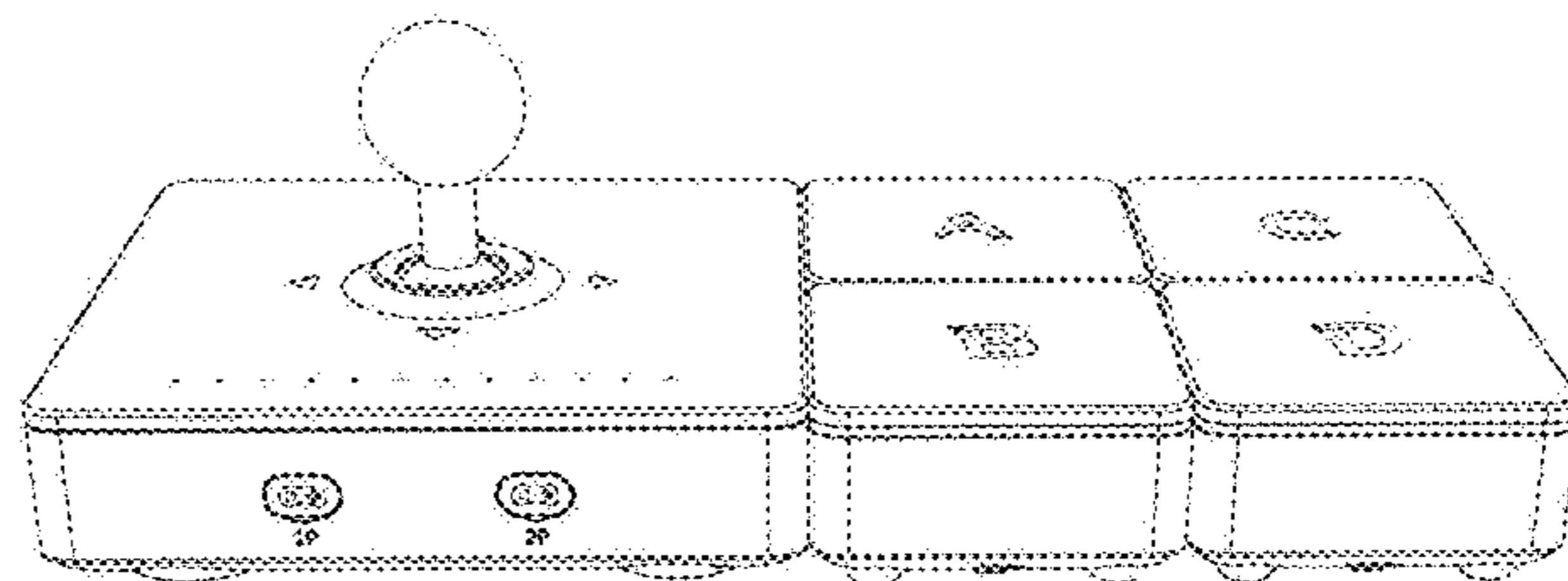
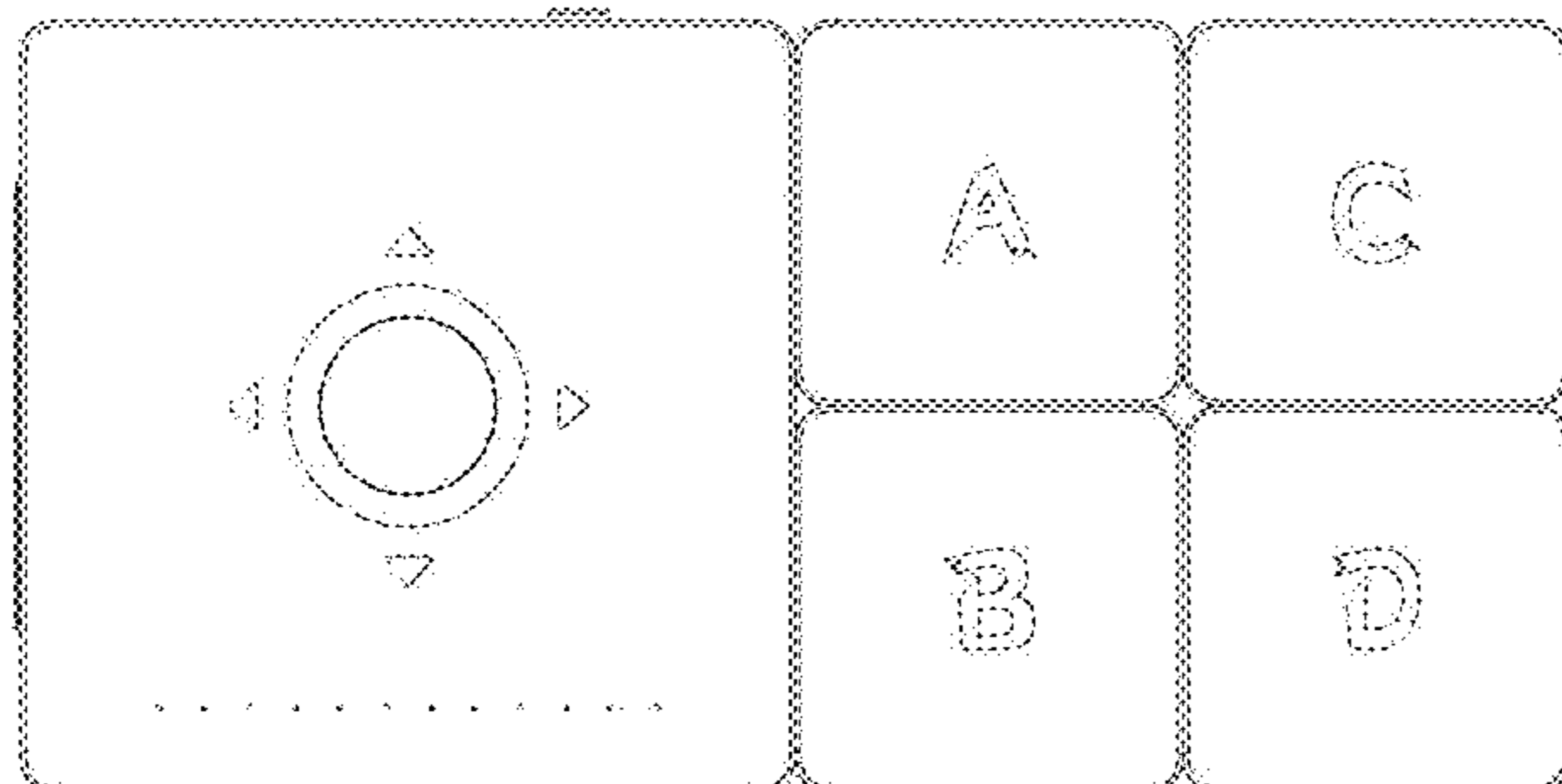

FIG. 20 is a front view of the second assembly of the video game controller;  
 FIG. 21 is a perspective view of the second assembly of the video game controller;  
 FIG. 22 is a top view of a third assembly of the video game controller;  
 FIG. 23 is a bottom view of the third assembly of the video game controller;  
 FIG. 24 is a left view of the third assembly of the video game controller;  
 FIG. 25 is a right view of the third assembly of the video game controller;  
 FIG. 26 is a back view of the third assembly of the video game controller;  
 FIG. 27 is a front view of the third assembly of the video game controller;  
 FIG. 28 is a perspective view of the third assembly of the video game controller;  
 FIG. 29 is a top view of a fourth assembly of the video game controller;  
 FIG. 30 is a bottom view of the fourth assembly of the video game controller;  
 FIG. 31 is a left view of the fourth assembly of the video game controller;  
 FIG. 32 is a right view of the fourth assembly of the video game controller;  
 FIG. 33 is a back view of the fourth assembly of the video game controller;  
 FIG. 34 is a front view of the fourth assembly of the video game controller;  
 FIG. 35 is a perspective view of the fourth assembly of the video game controller;  
 FIG. 36 is a top view of a fifth assembly of the video game controller;  
 FIG. 37 is a bottom view of the fifth assembly of the video game controller;  
 FIG. 38 is a left view of the fifth assembly of the video game controller;  
 FIG. 39 is a right view of the fifth assembly of the video game controller;  
 FIG. 40 is a back view of the fifth assembly of the video game controller;

FIG. 41 is a front view of the fifth assembly of the video game controller; and,  
 FIG. 42 is a perspective view of the fifth assembly of the video game controller.

**1 Claim, 42 Drawing Sheets**

(58) **Field of Classification Search**

CPC ..... H03J 2200/24; H03J 1/0025; H04N 21/4221; H04N 21/42204; G08C 2201/33; H01H 9/0214; H01H 9/0207; H01H 9/06; H01H 2009/065; H01H 2009/066  
 See application file for complete search history.

(56) **References Cited**

U.S. PATENT DOCUMENTS

D378,302	S	*	3/1997	Kin-Man Tse	.....	D14/413
D614,145	S	*	4/2010	Arosio	.....	D13/168
D649,124	S	*	11/2011	Jacoby	.....	D13/168
D665,383	S	*	8/2012	McManigal	.....	D14/218
D712,381	S	*	9/2014	Hwang	.....	D14/218
D749,061	S	*	2/2016	Lee	.....	D14/218
D781,246	S	*	3/2017	Zhang	.....	D13/162
D838,252	S	*	1/2019	Shin	.....	D14/125
D855,576	S	*	8/2019	Yang	.....	D13/168
D885,495	S	*	5/2020	Su	.....	D21/491

OTHER PUBLICATIONS

HORI Store. HORI Fighting Stick Mini . . . , available at amazon.com. date first available Sep. 3, 2015, site visited Feb. 22, 2022, Available at URL: [https://www.amazon.com/HORI-Fighting-Stick-Mini-PlayStation-4/dp/B014KXMEW4/ref=psdc\\_6427814011\\_t3\\_B01N9JMYPX](https://www.amazon.com/HORI-Fighting-Stick-Mini-PlayStation-4/dp/B014KXMEW4/ref=psdc_6427814011_t3_B01N9JMYPX) (Year: 2015).\*

Shopcutekills, Blind Box 1:6 Miniature Arcade . . . , available at ebay.com, date posted on Feb. 17, 2022, site visited Feb. 22, 2022, Available at URL: <https://www.ebay.com/itm/403476500268?chn=ps&mkevt=1&mkcid=28> (Year: 2022).\*

\* cited by examiner

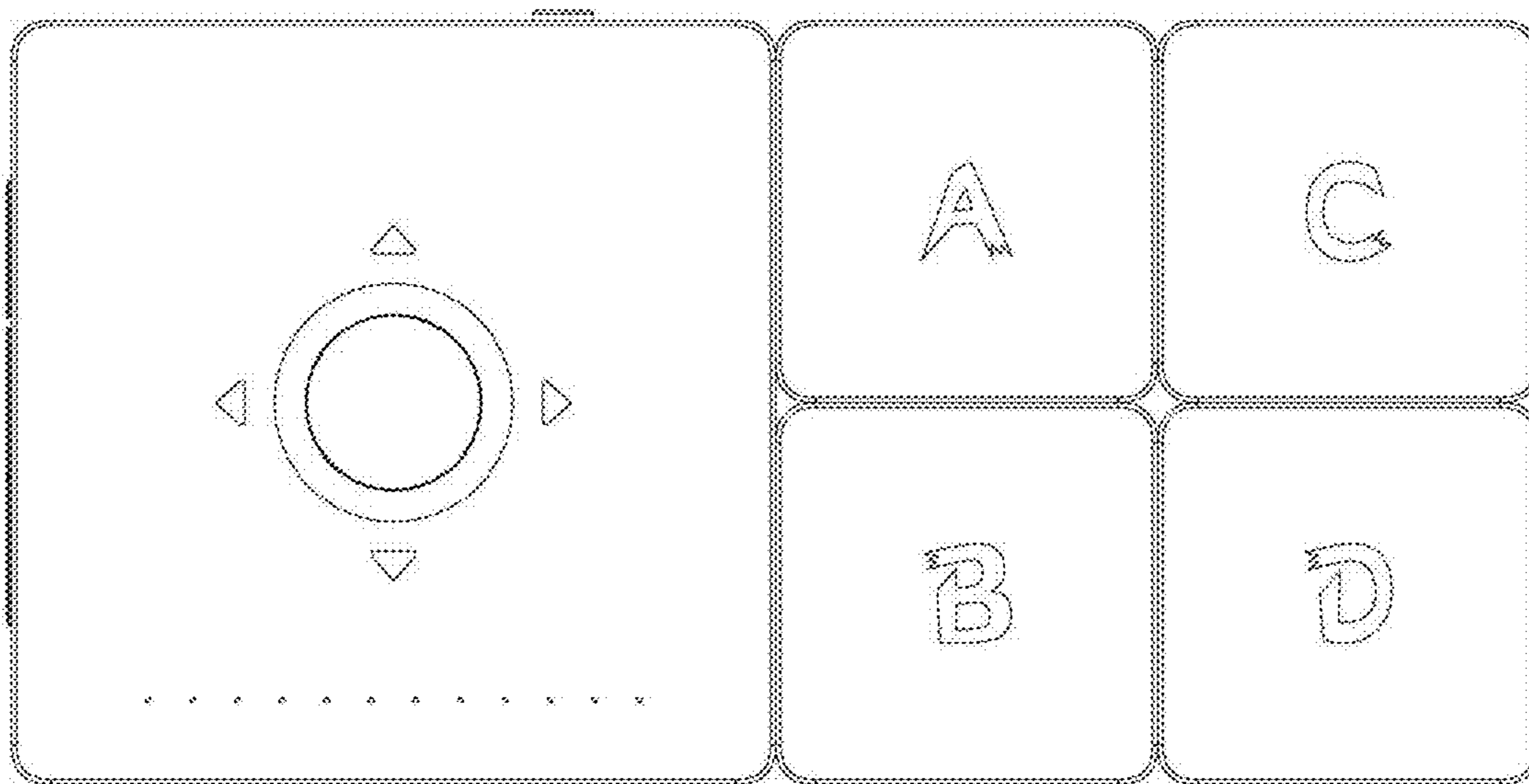

Fig. 1



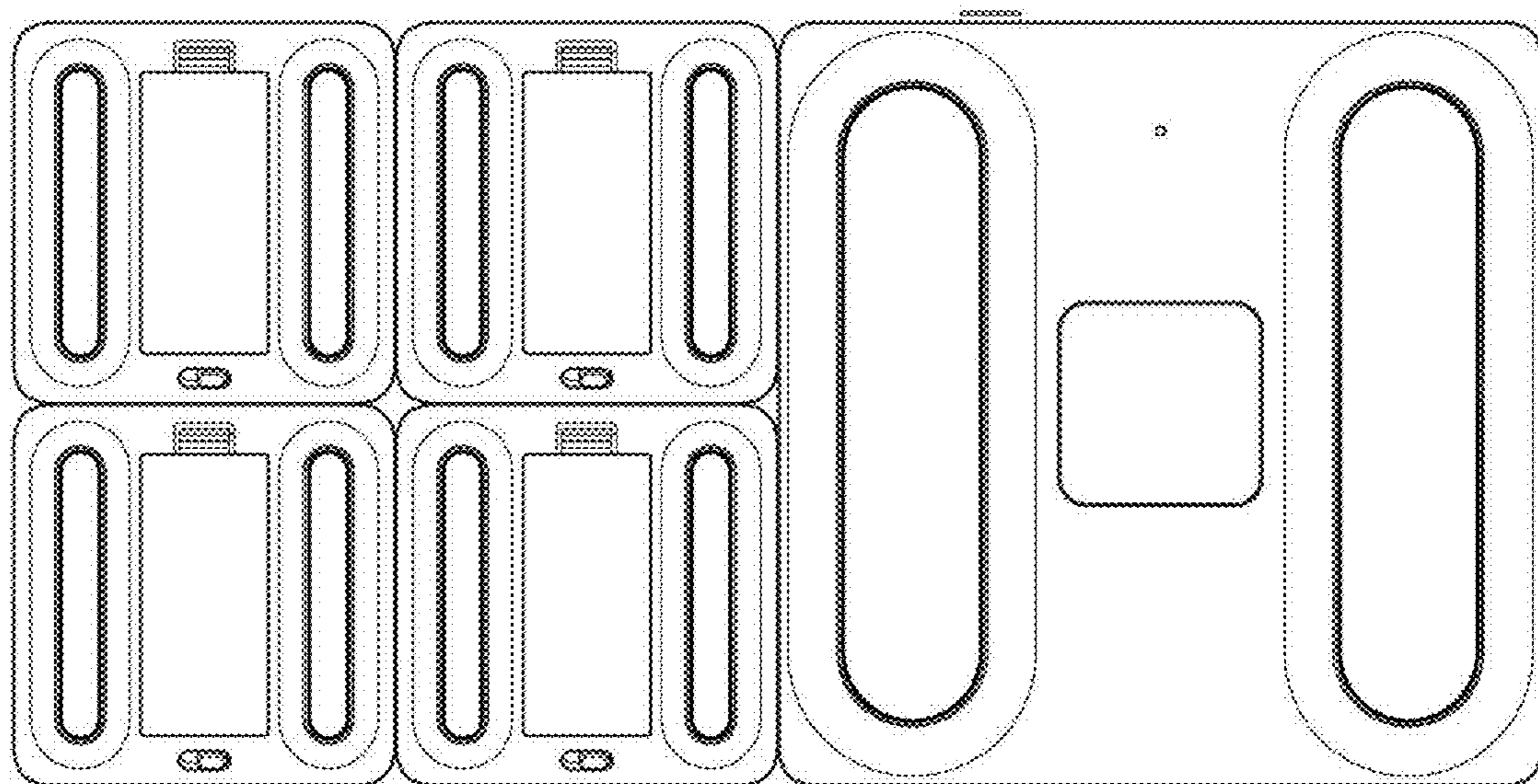

Fig. 2

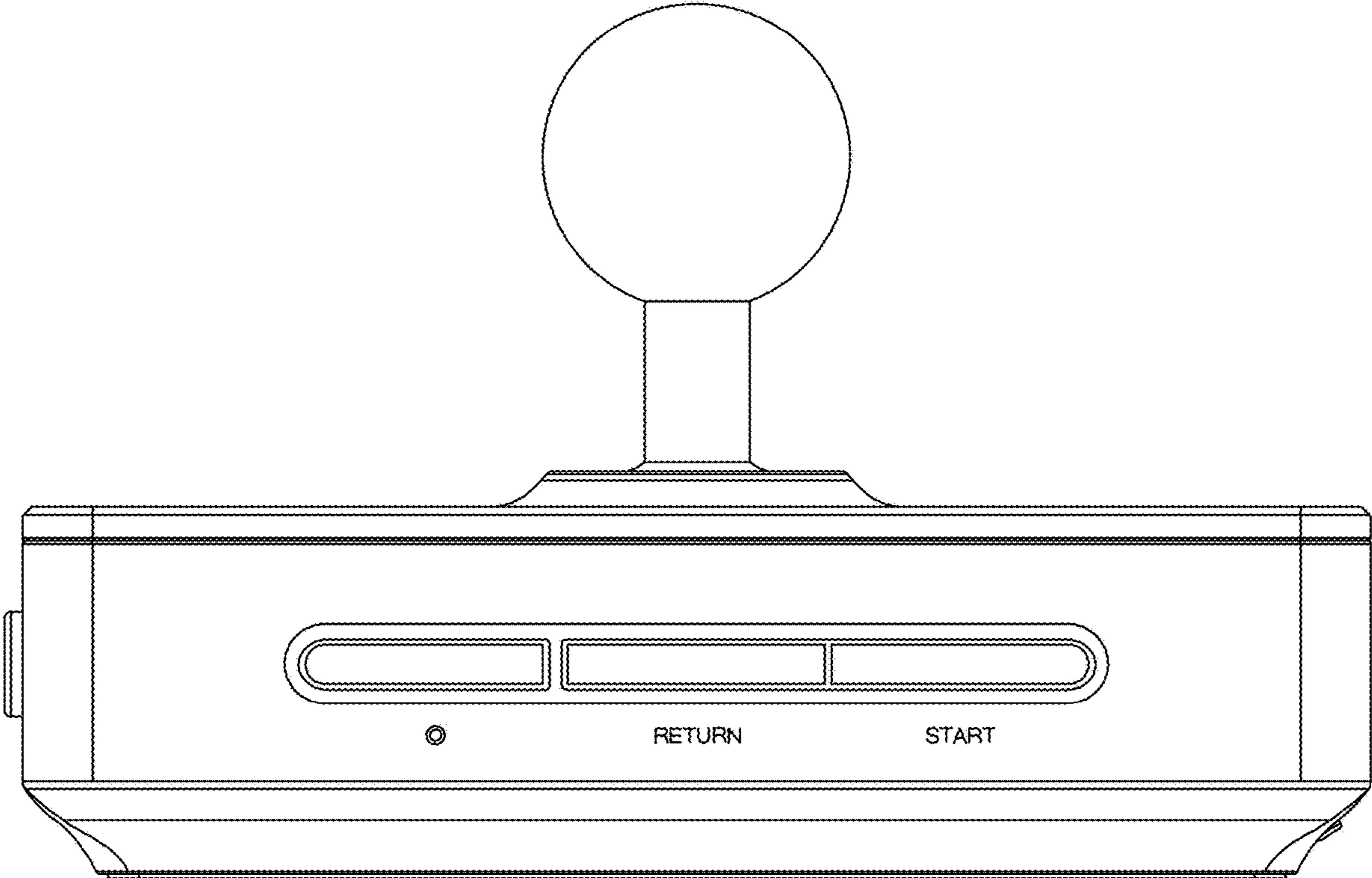

FIG. 3

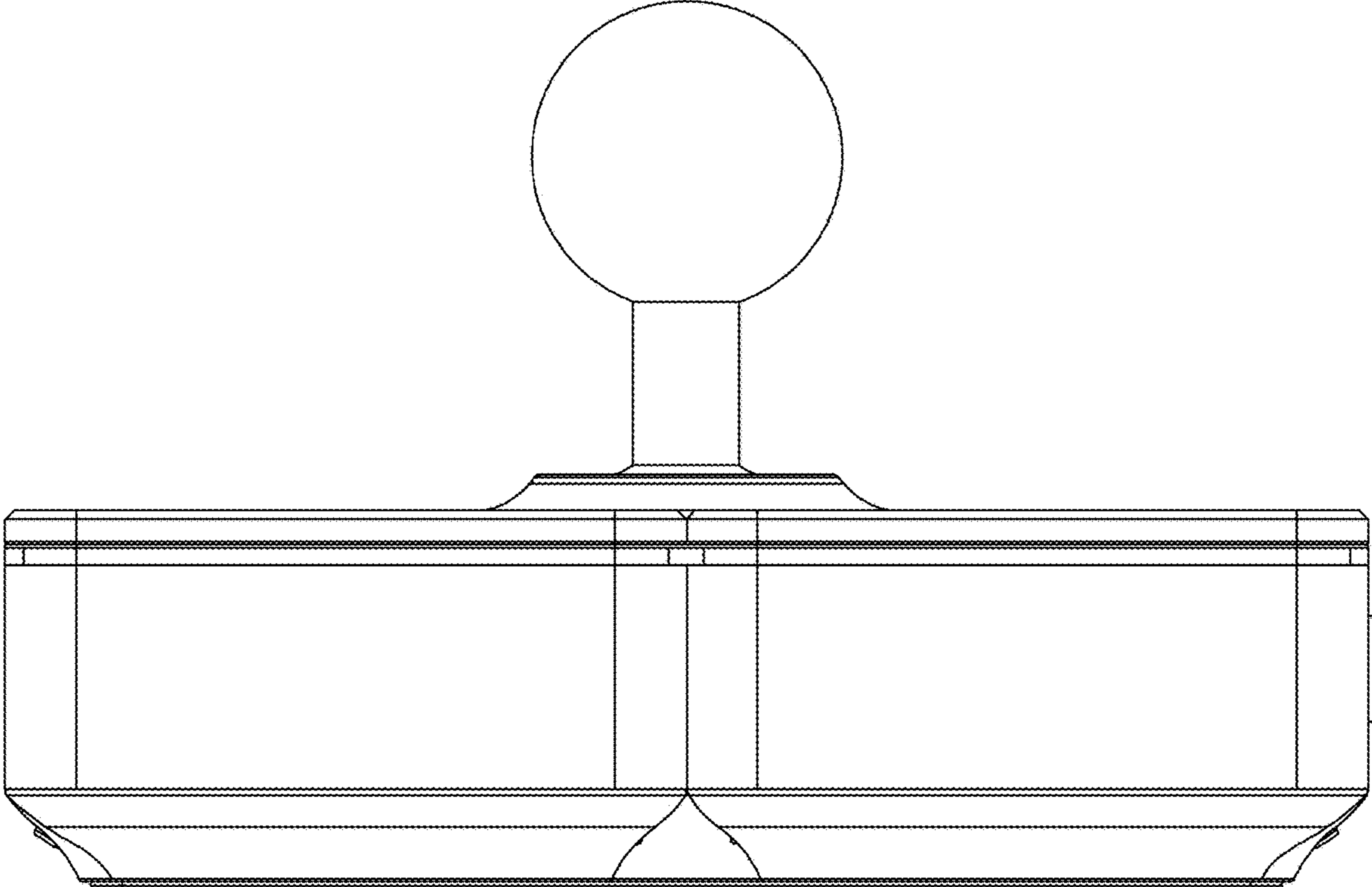

FIG. 4

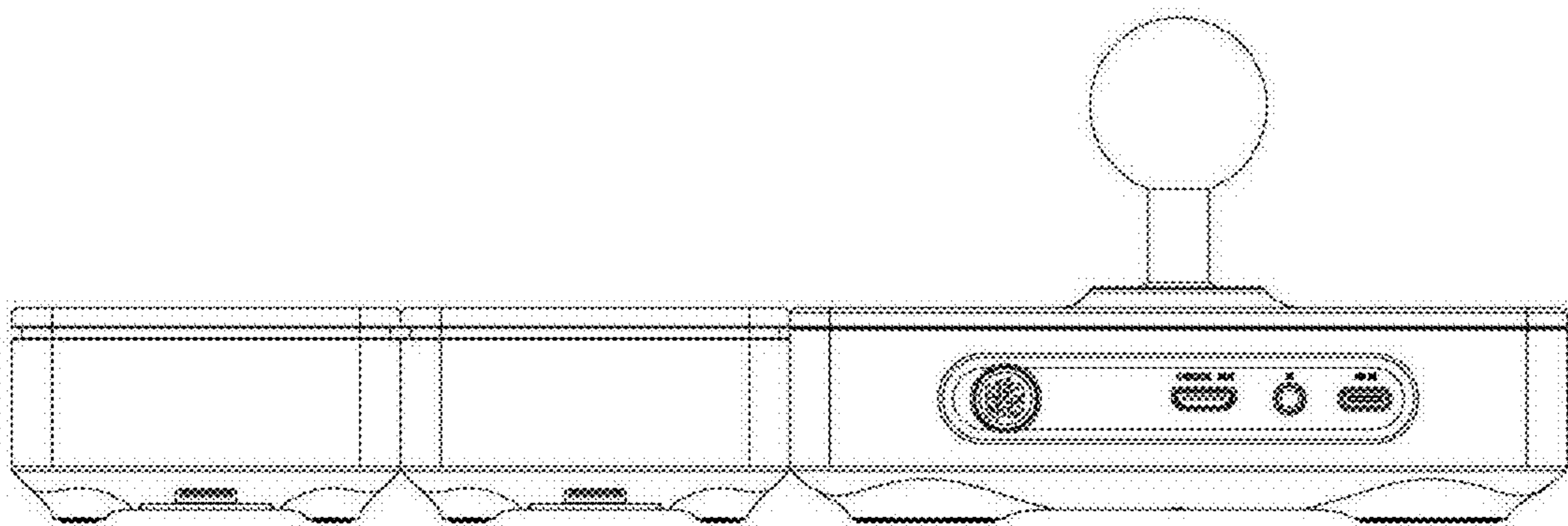

Fig. 5

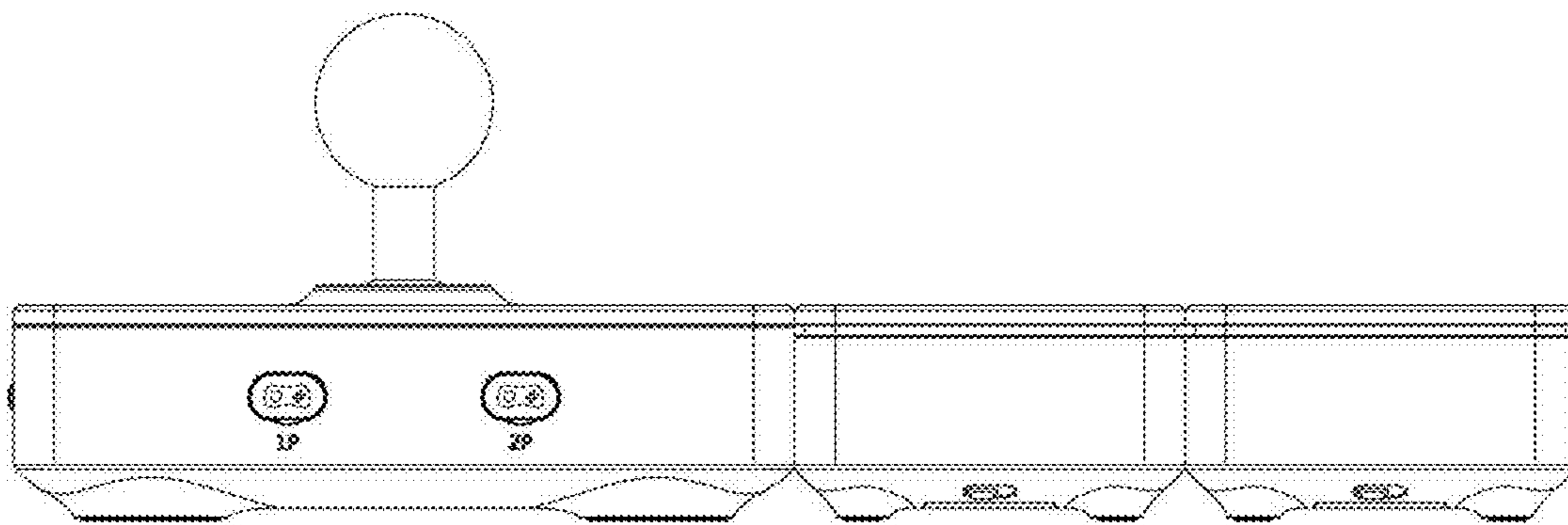

Fig. 6



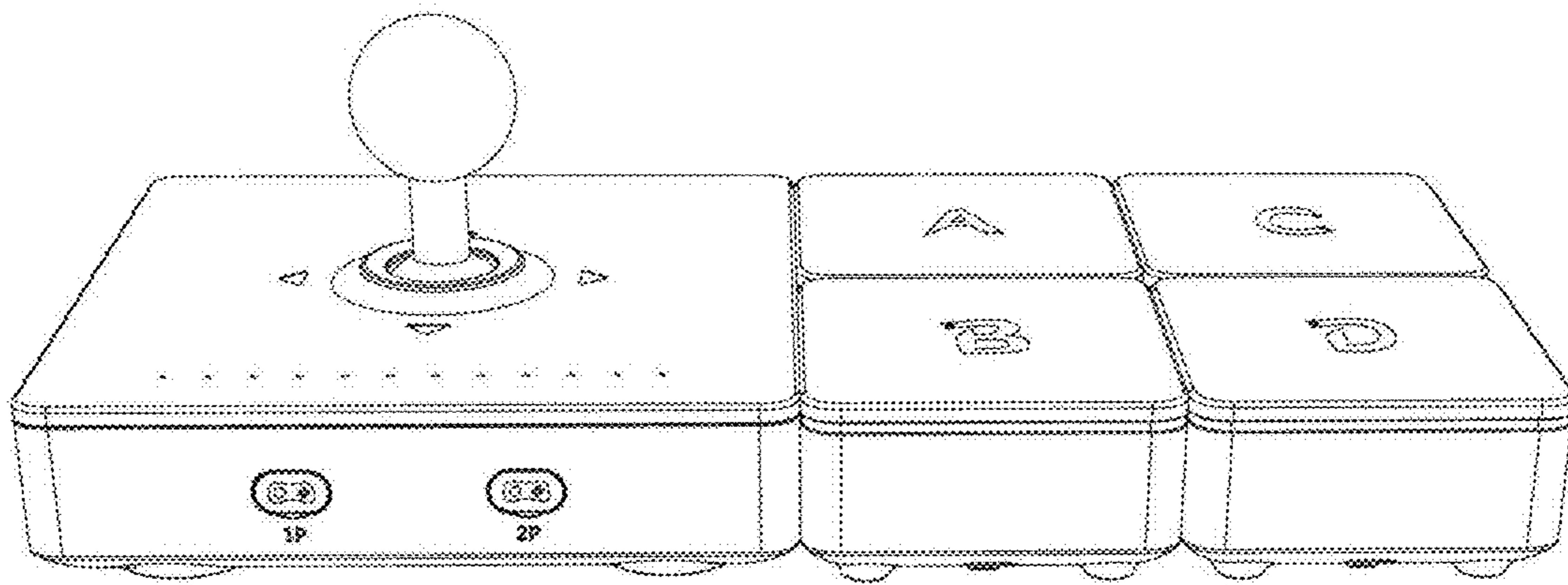

Fig. 7



**Fig. 8**

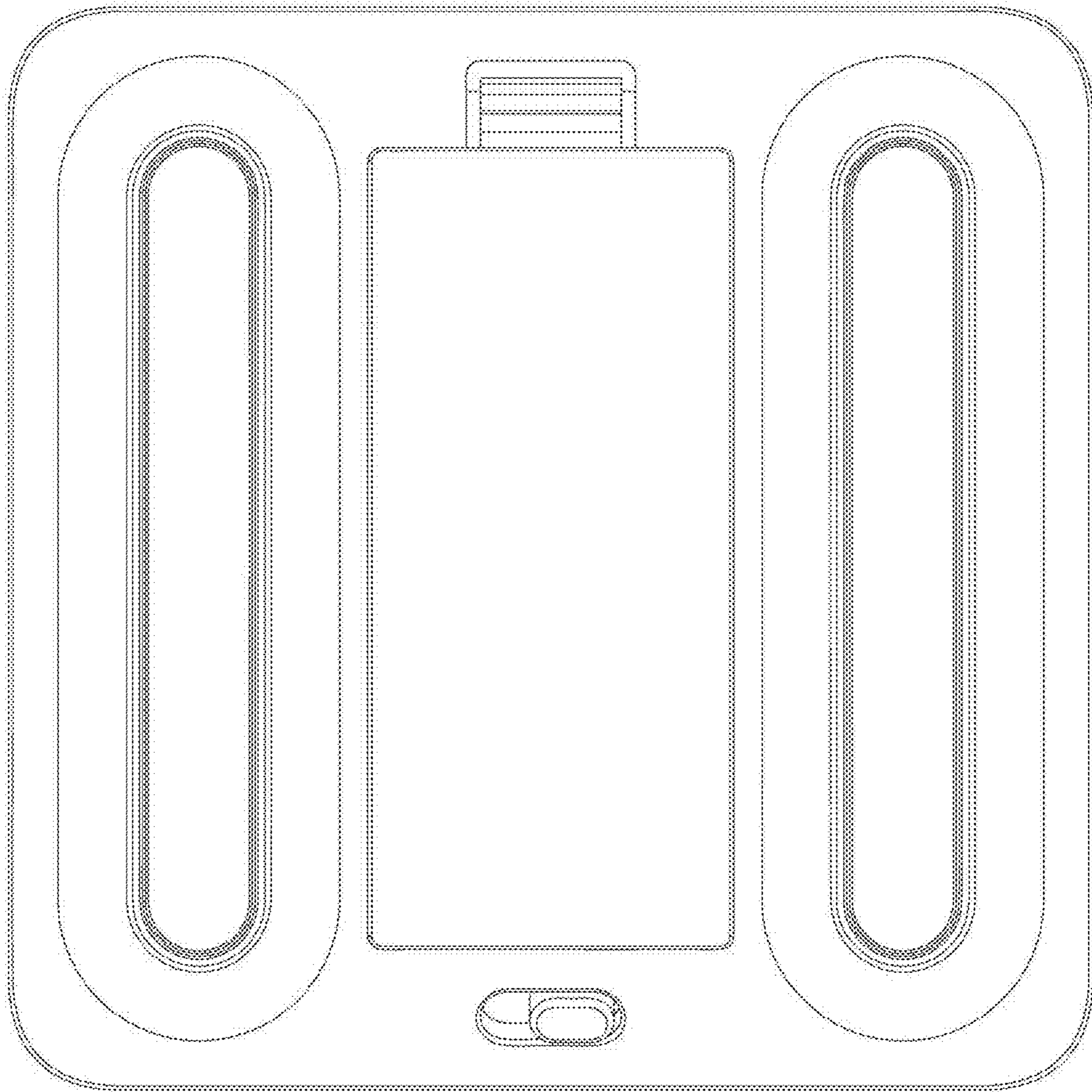

Fig. 9

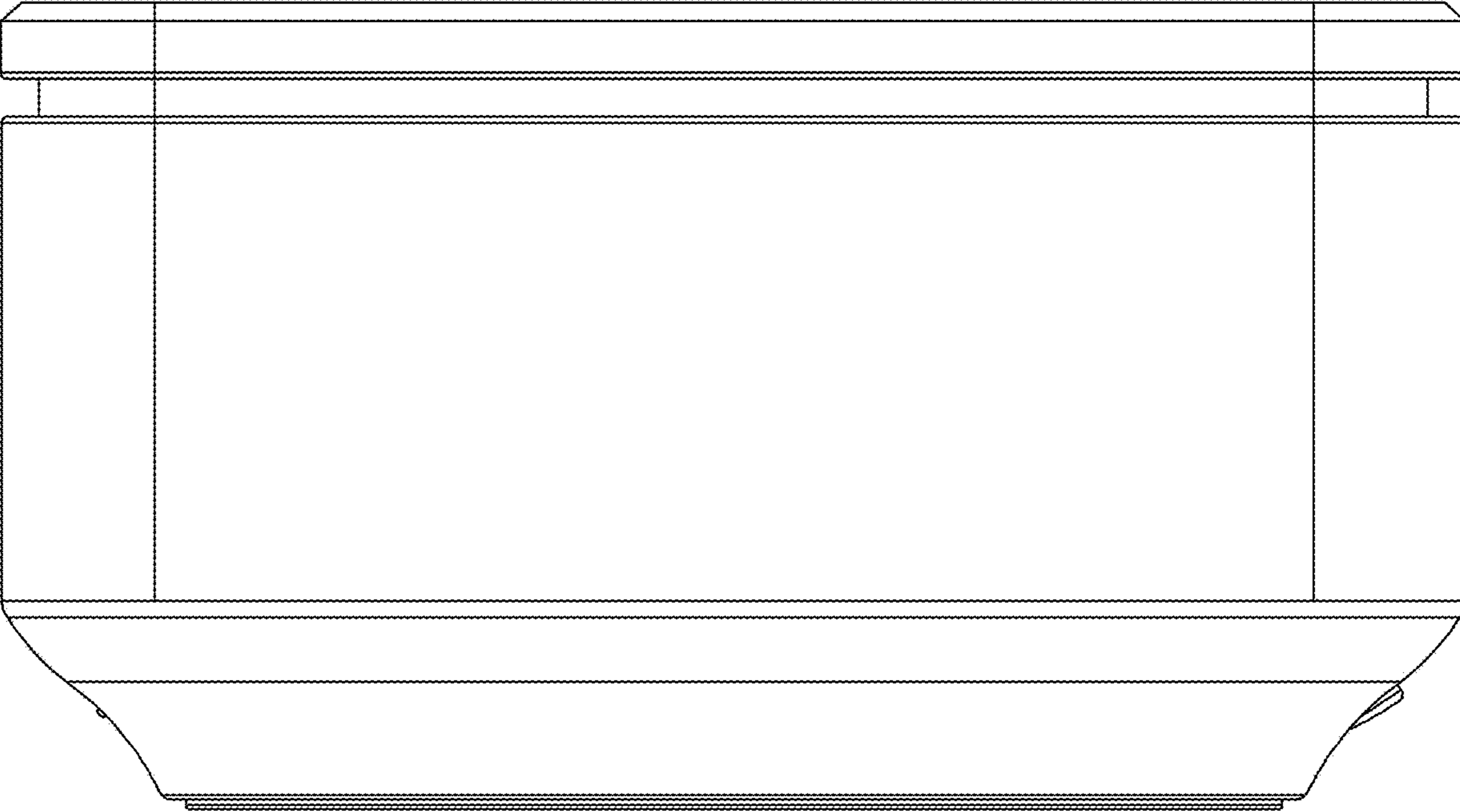

FIG. 10

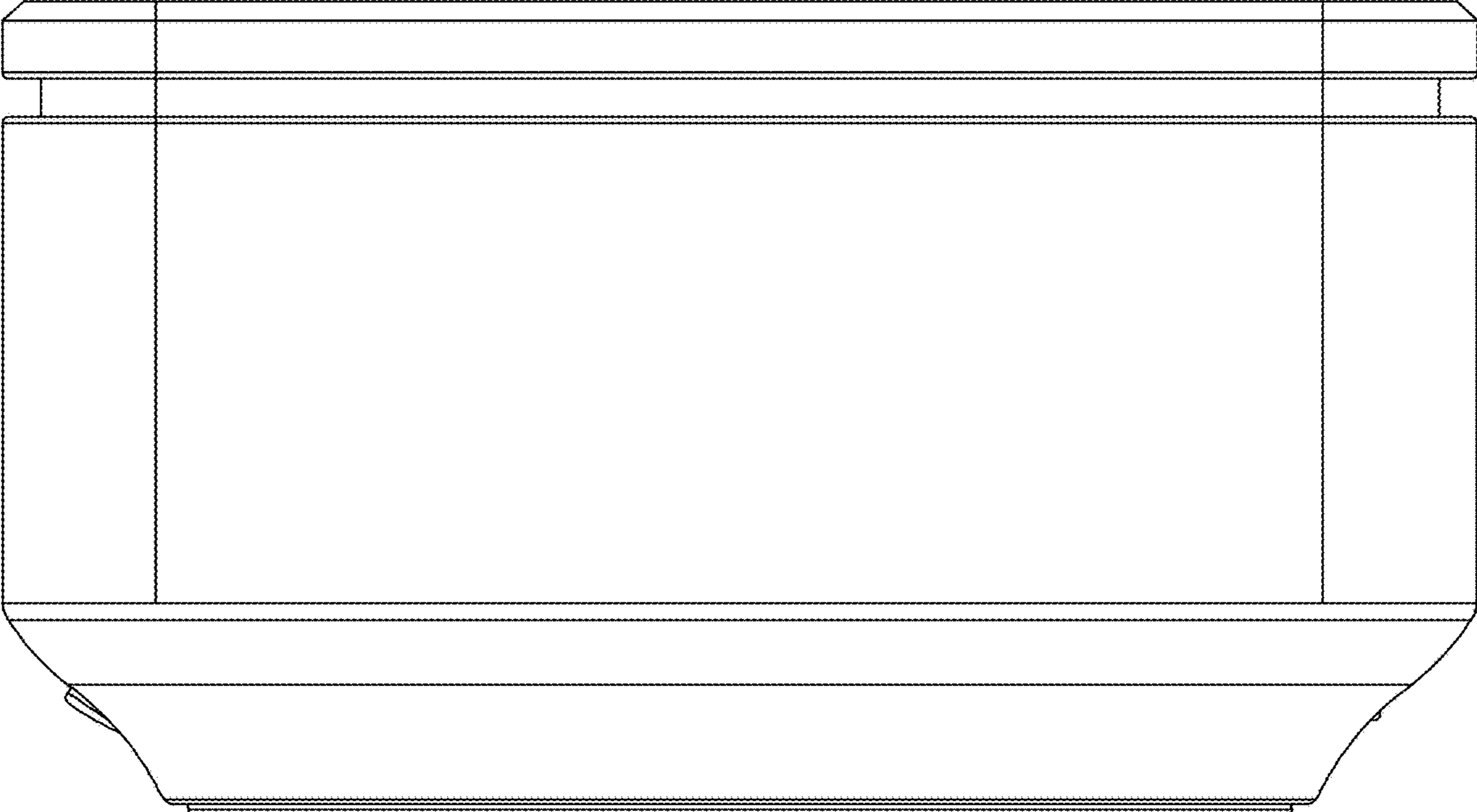

FIG. 11



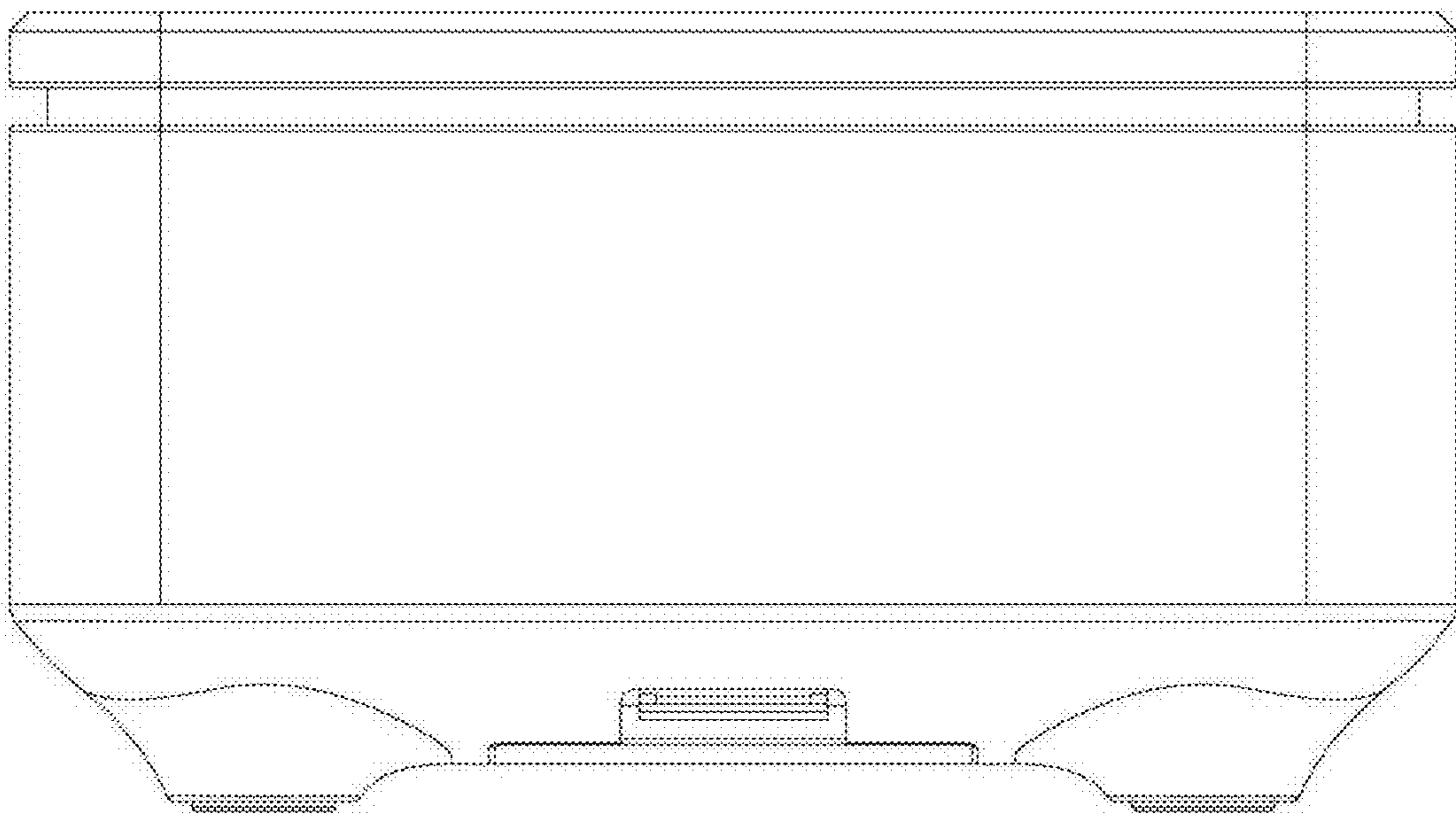

Fig. 12

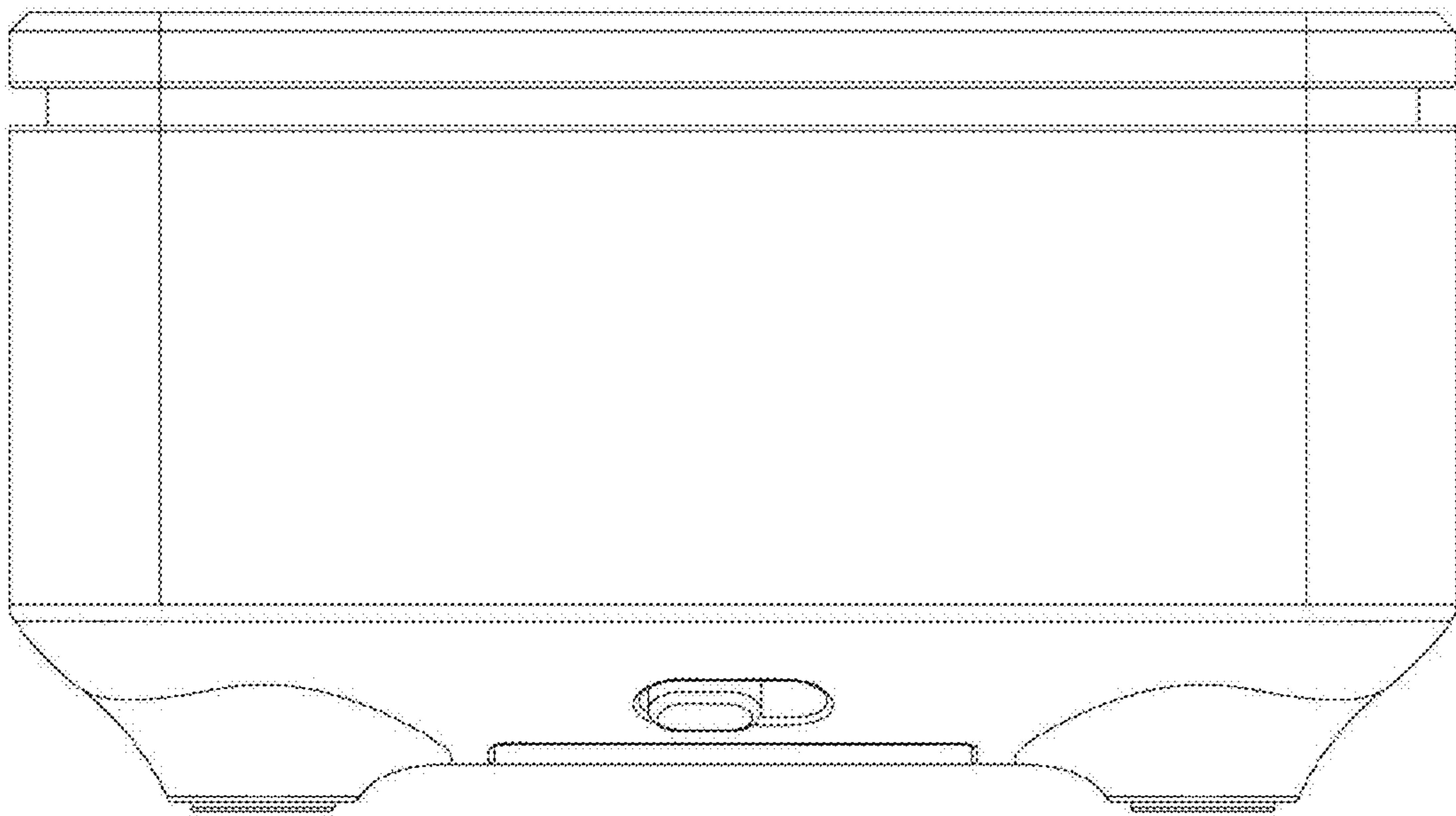

Fig. 13

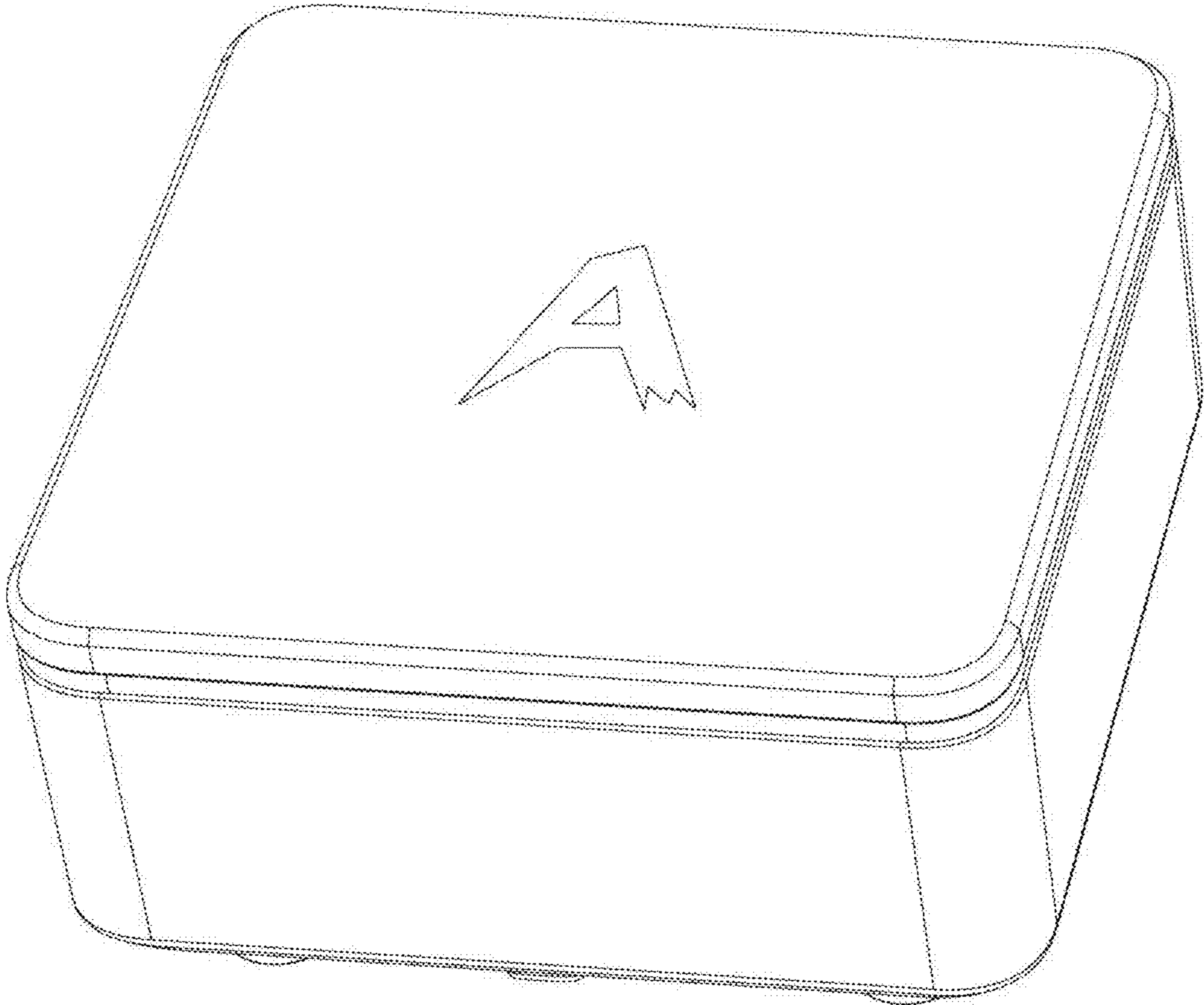
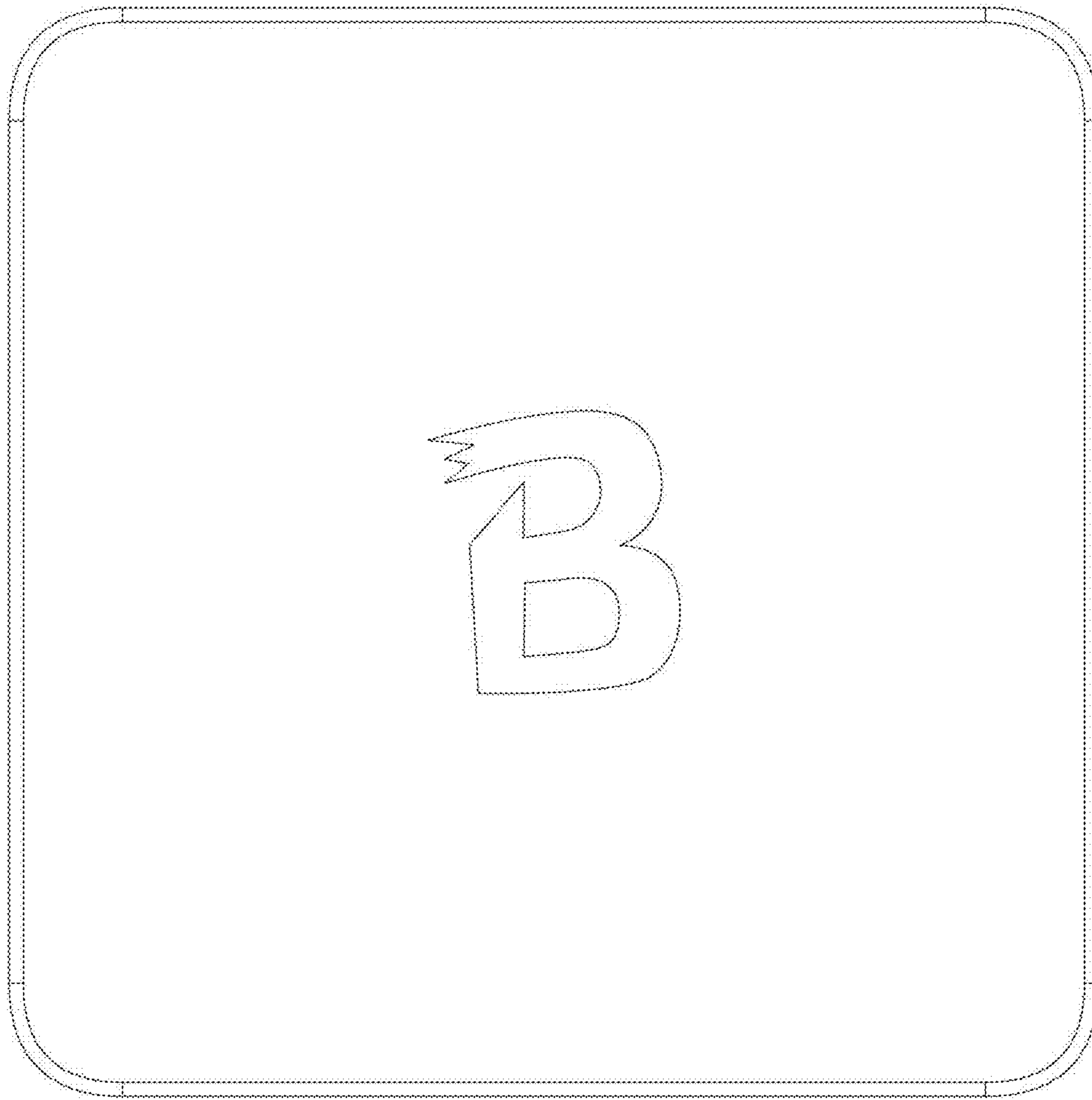

Fig. 14



**Fig. 15**

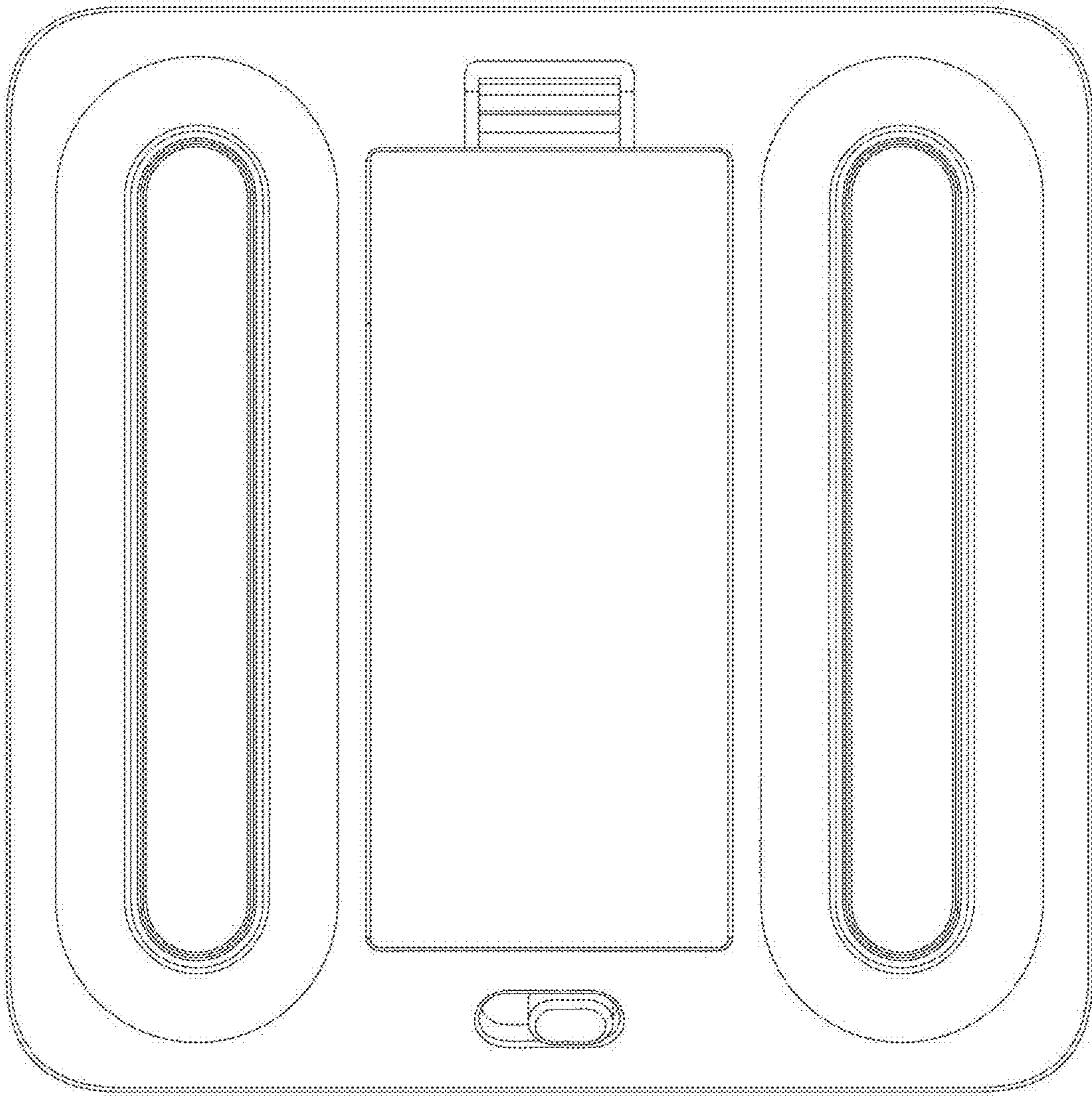

Fig. 16



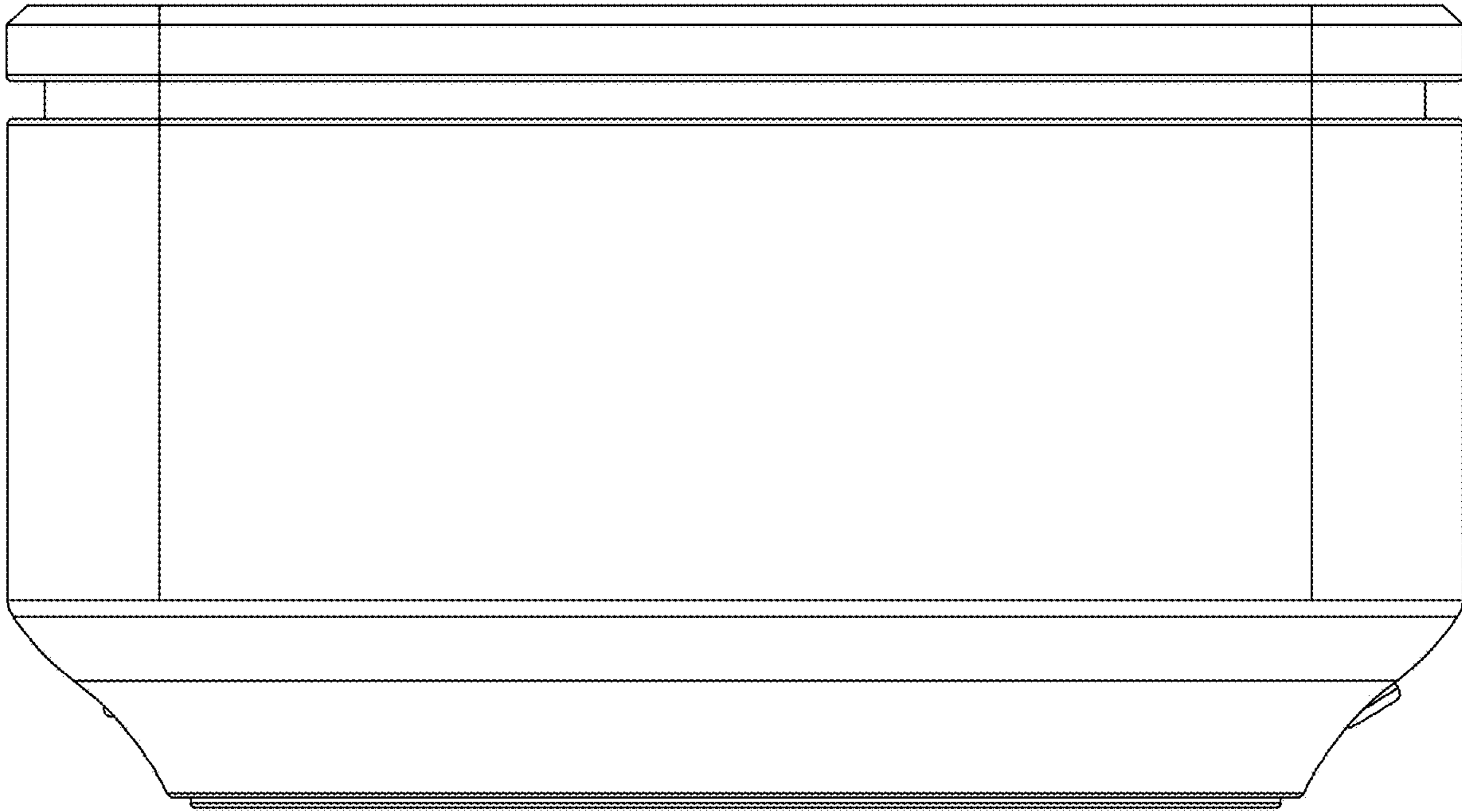

FIG. 17

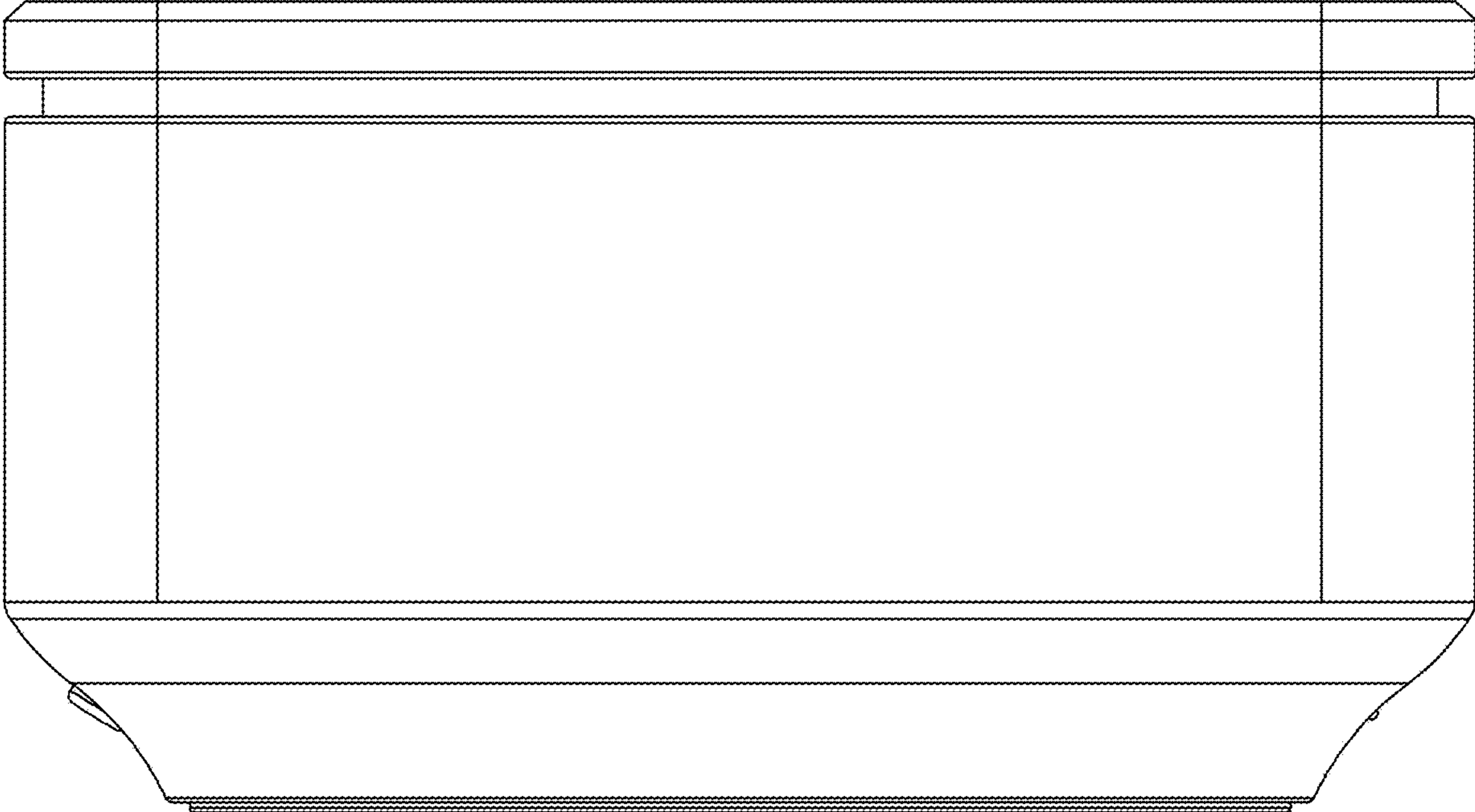

FIG. 18

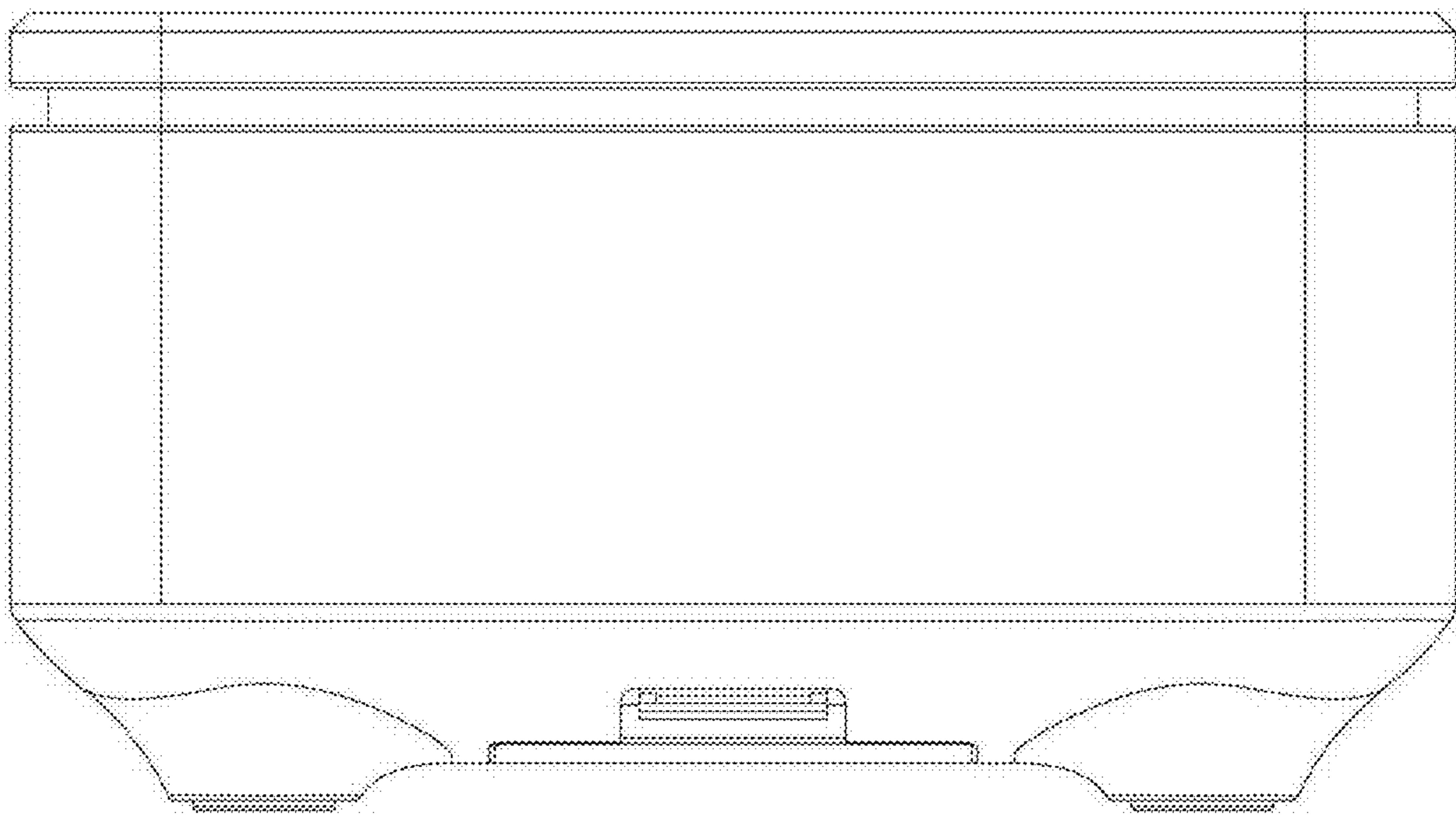
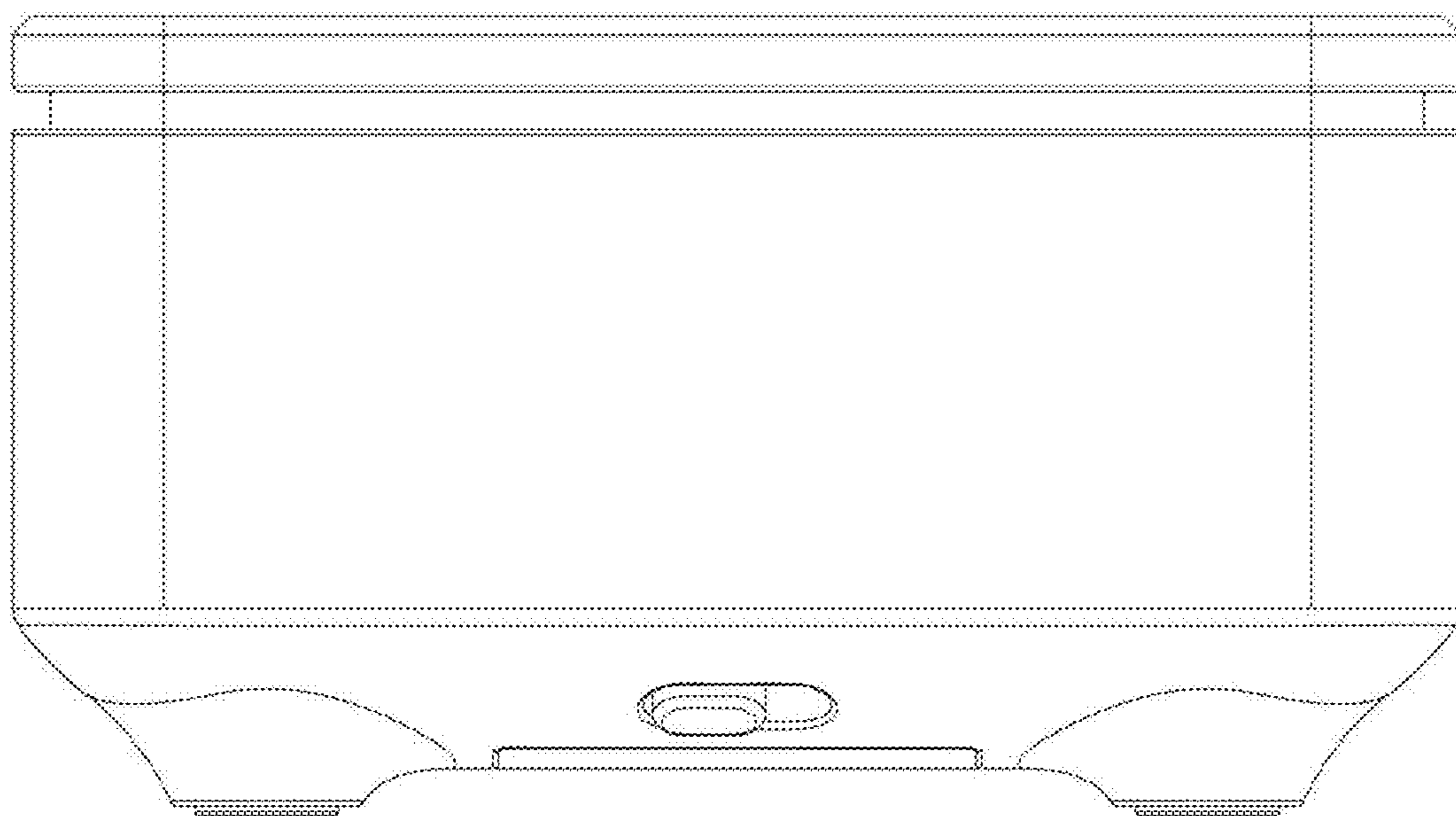

Fig. 19



**Fig. 20**

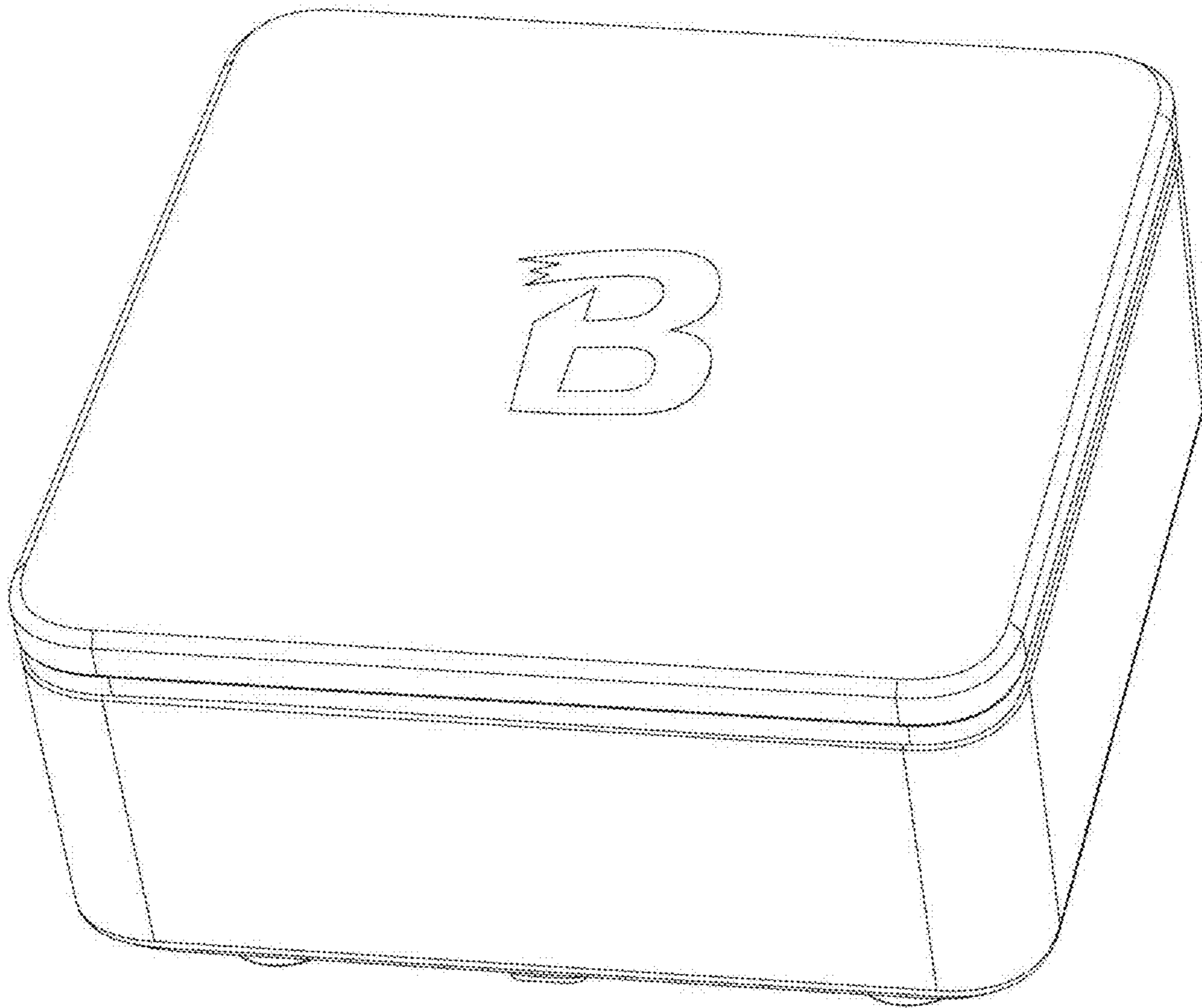
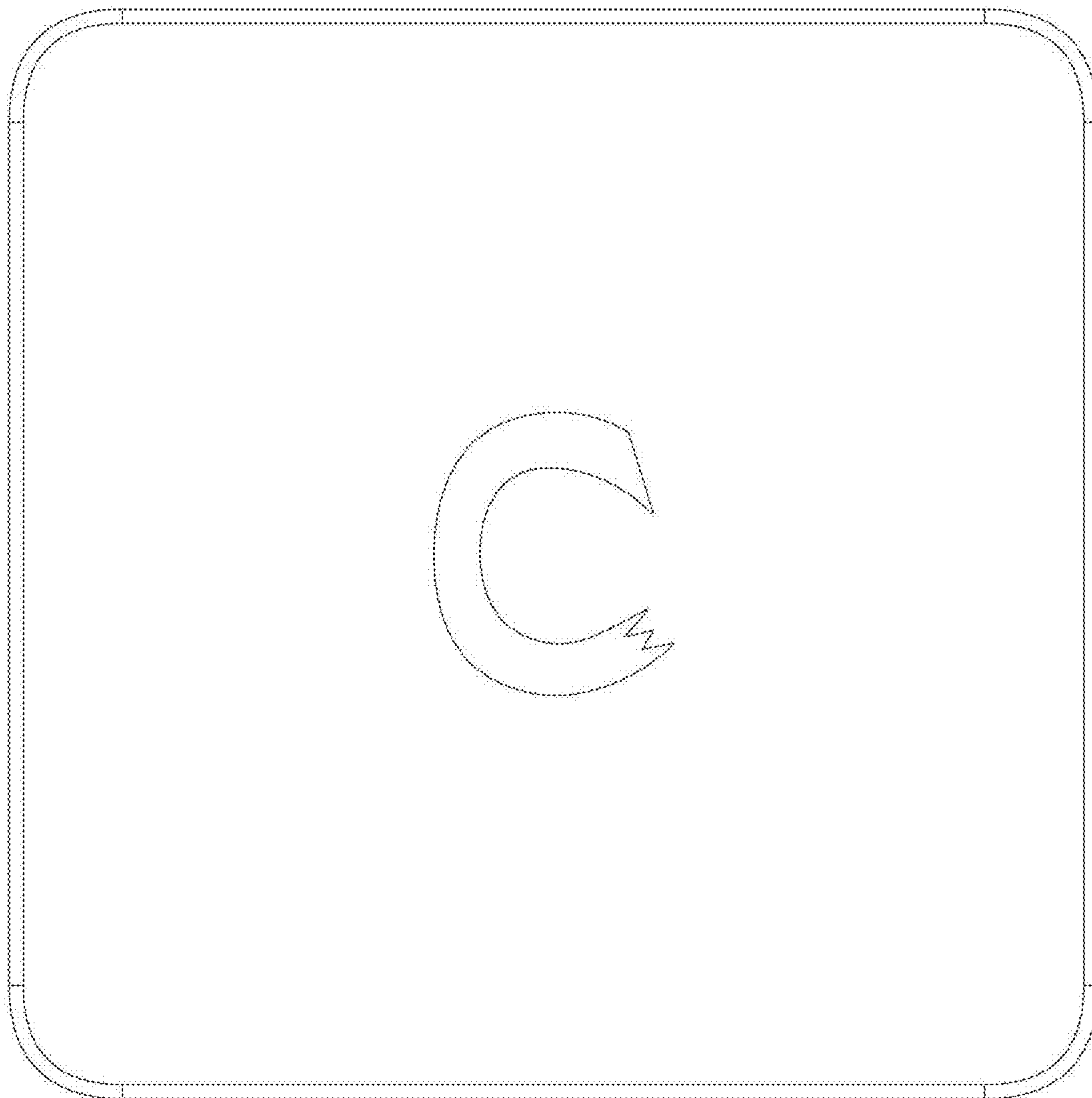

Fig. 21





**Fig. 22**

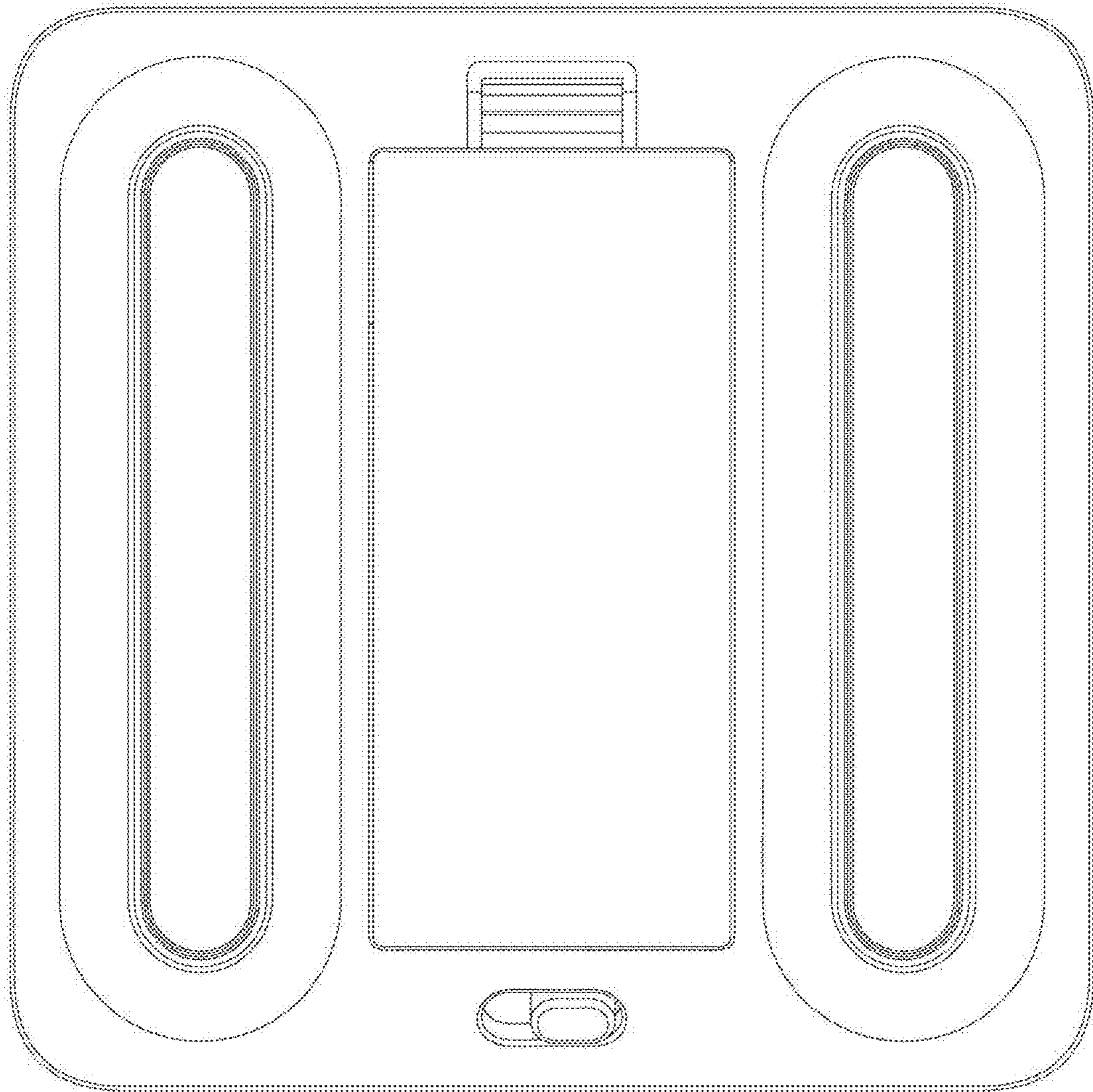

Fig. 23

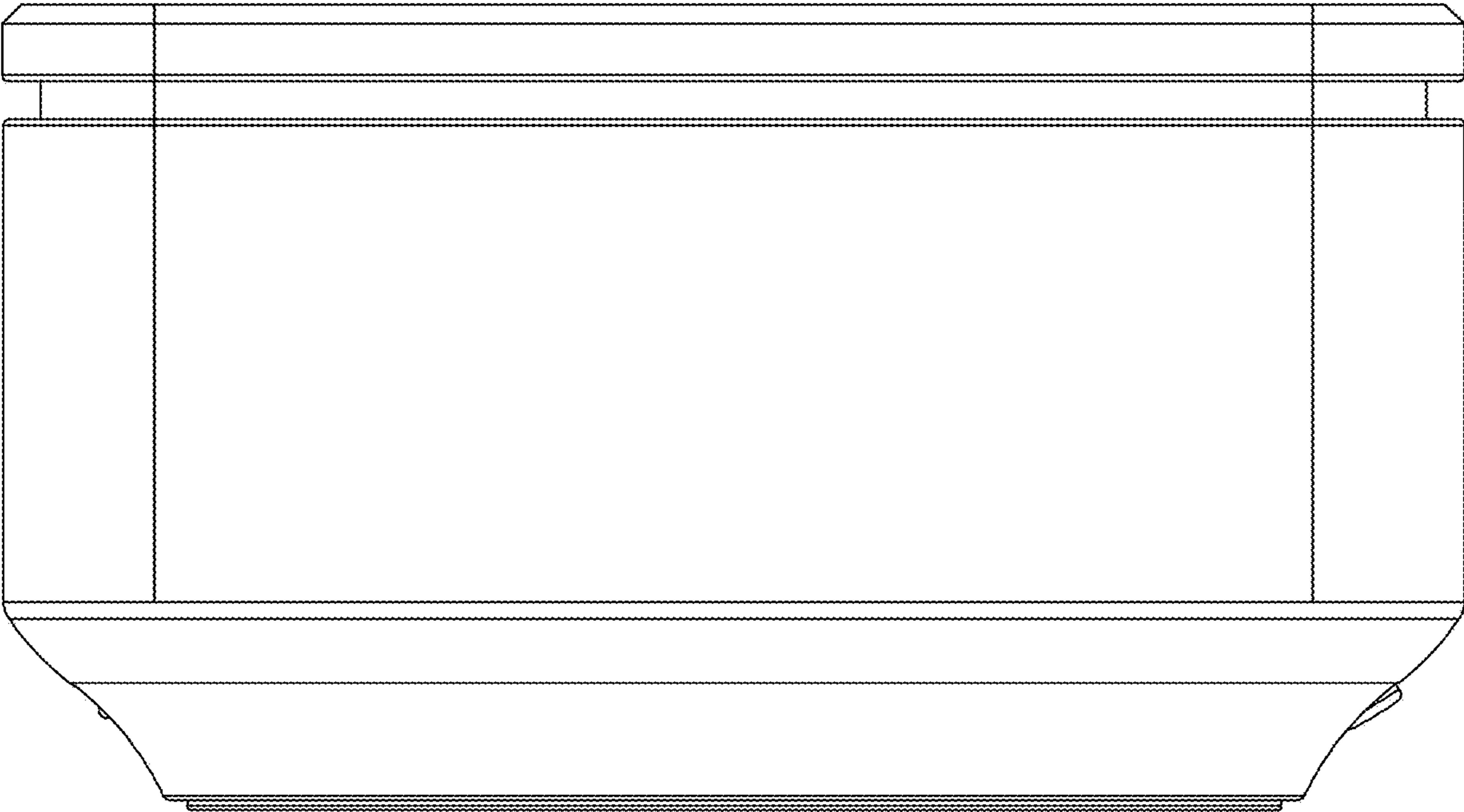

FIG. 24

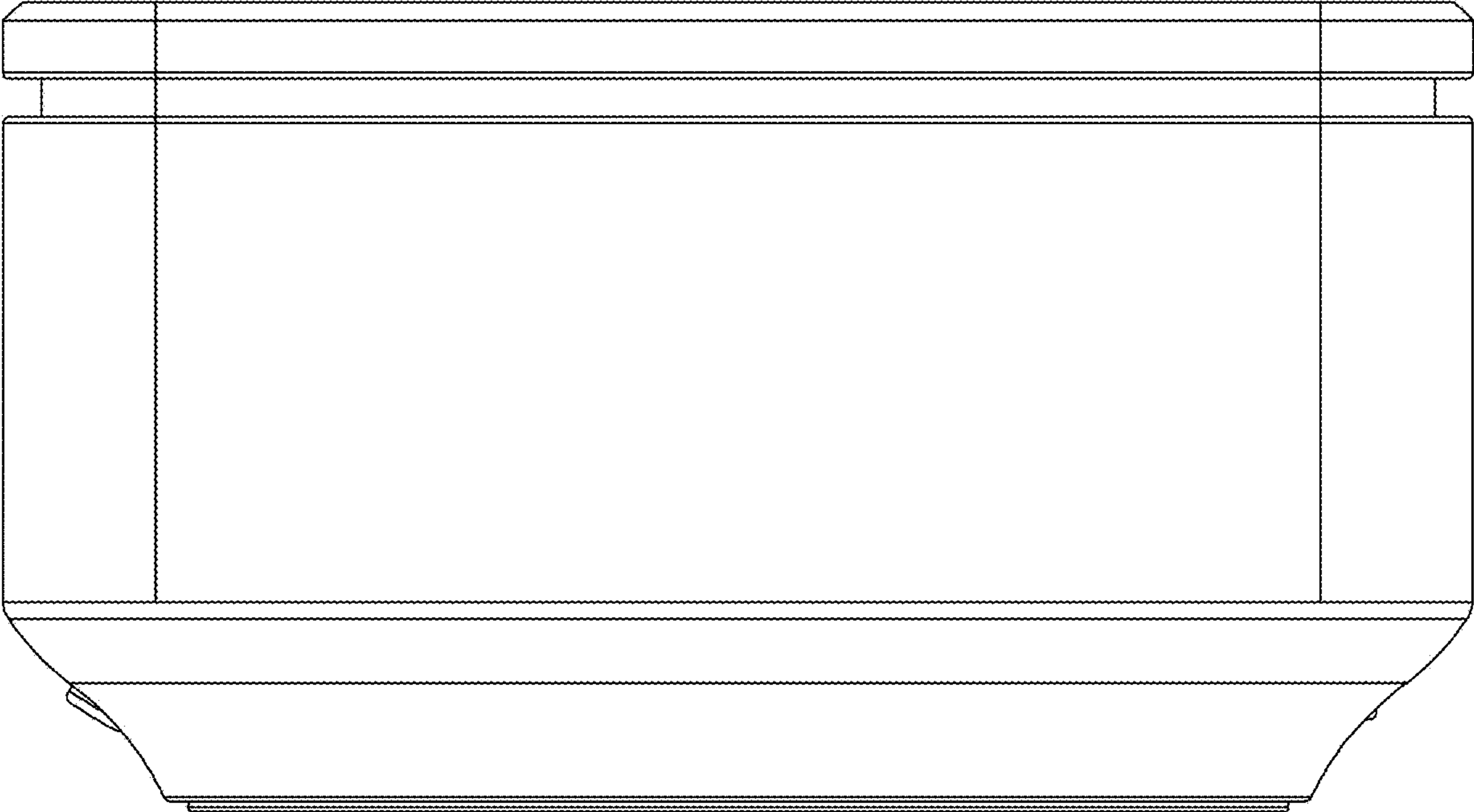

FIG. 25

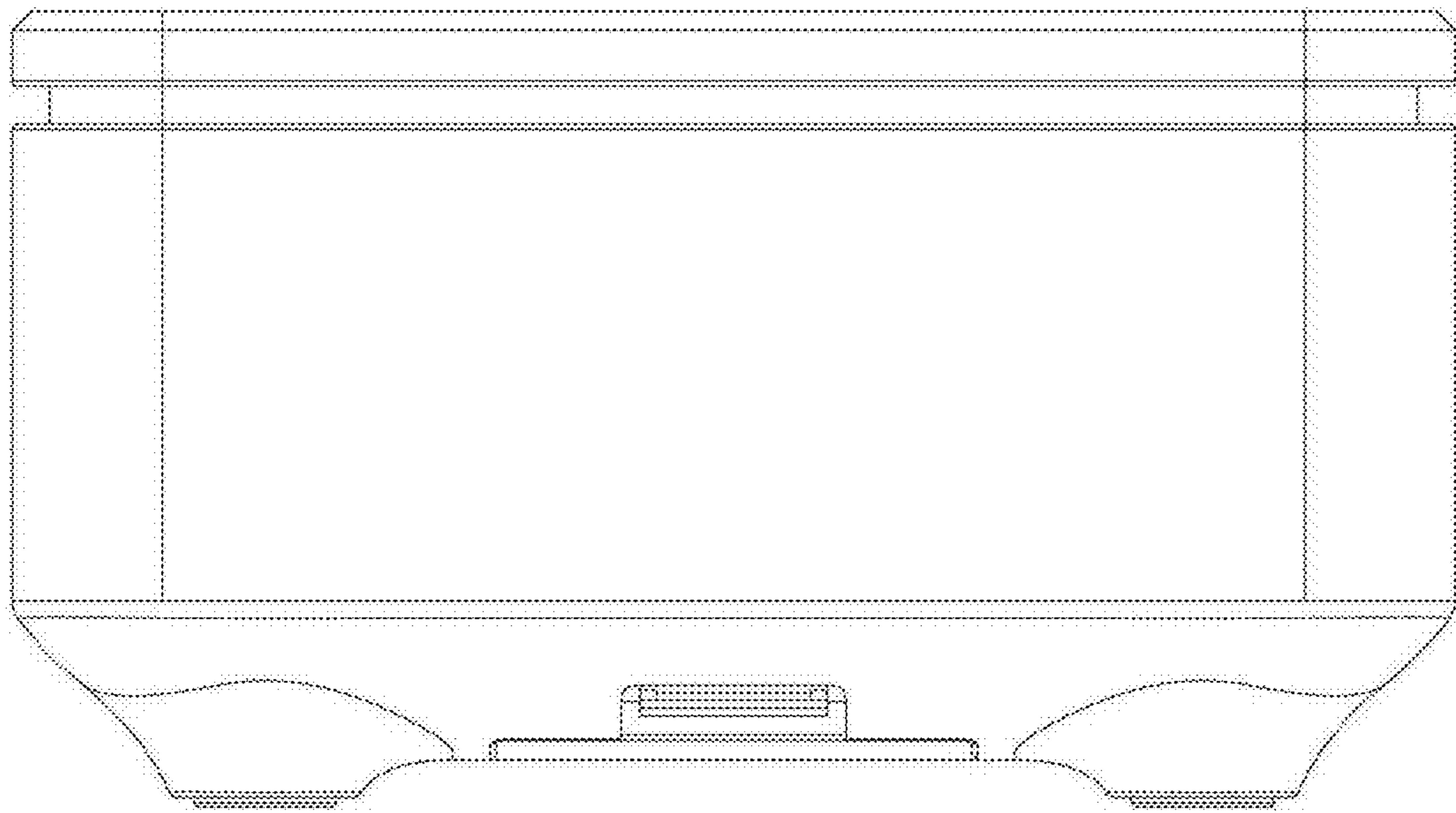

Fig. 26



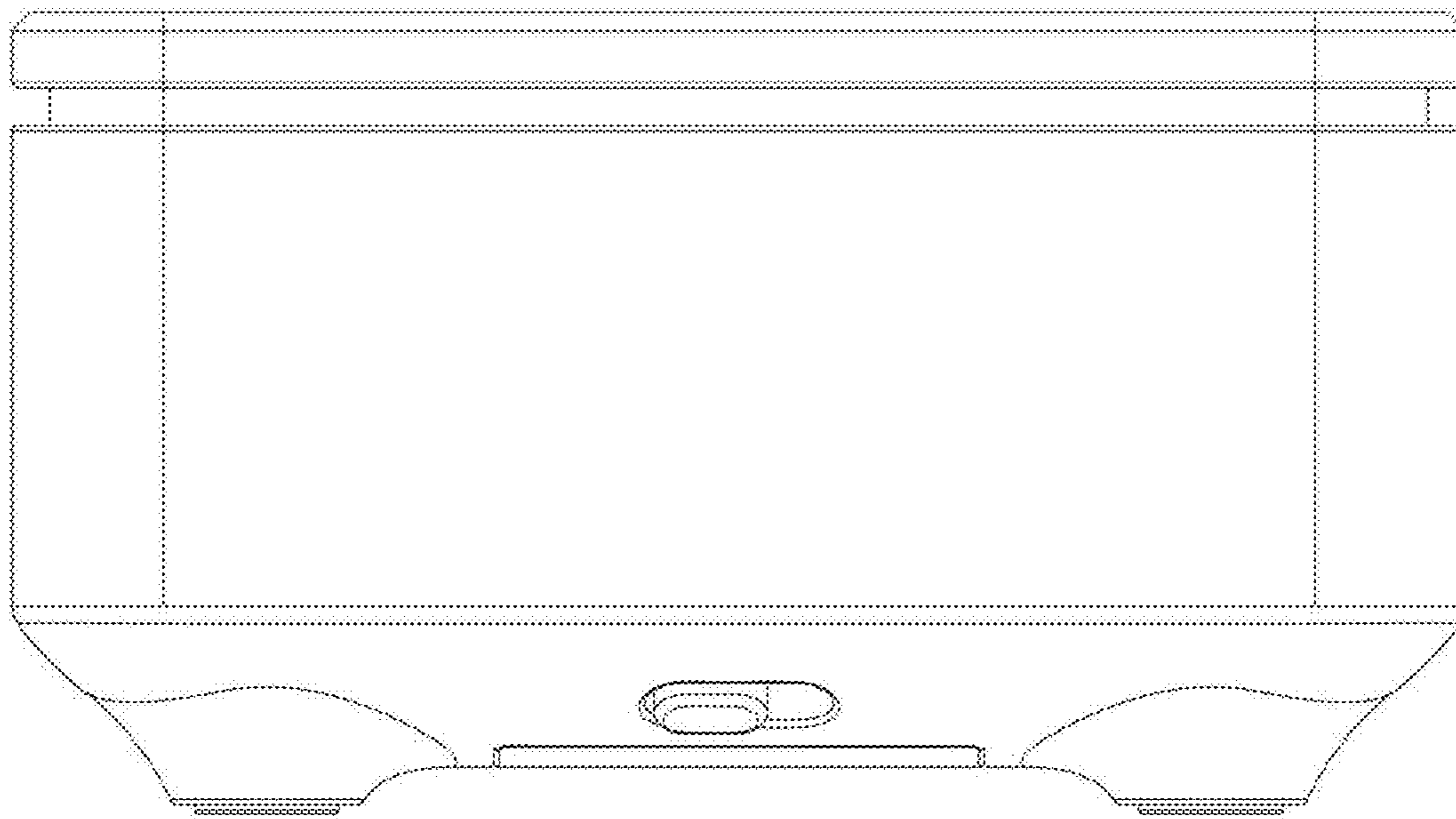

Fig. 27

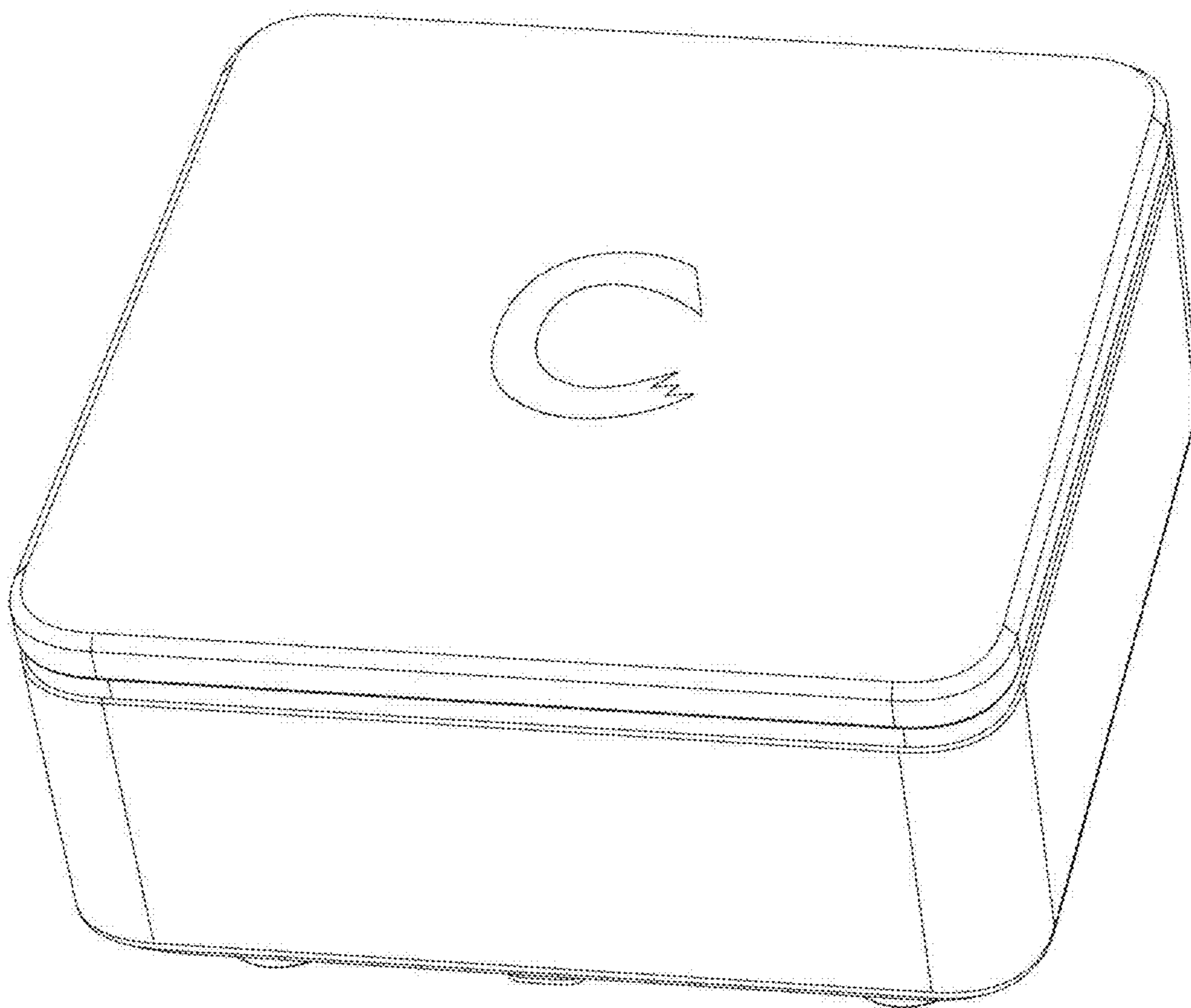

Fig. 28

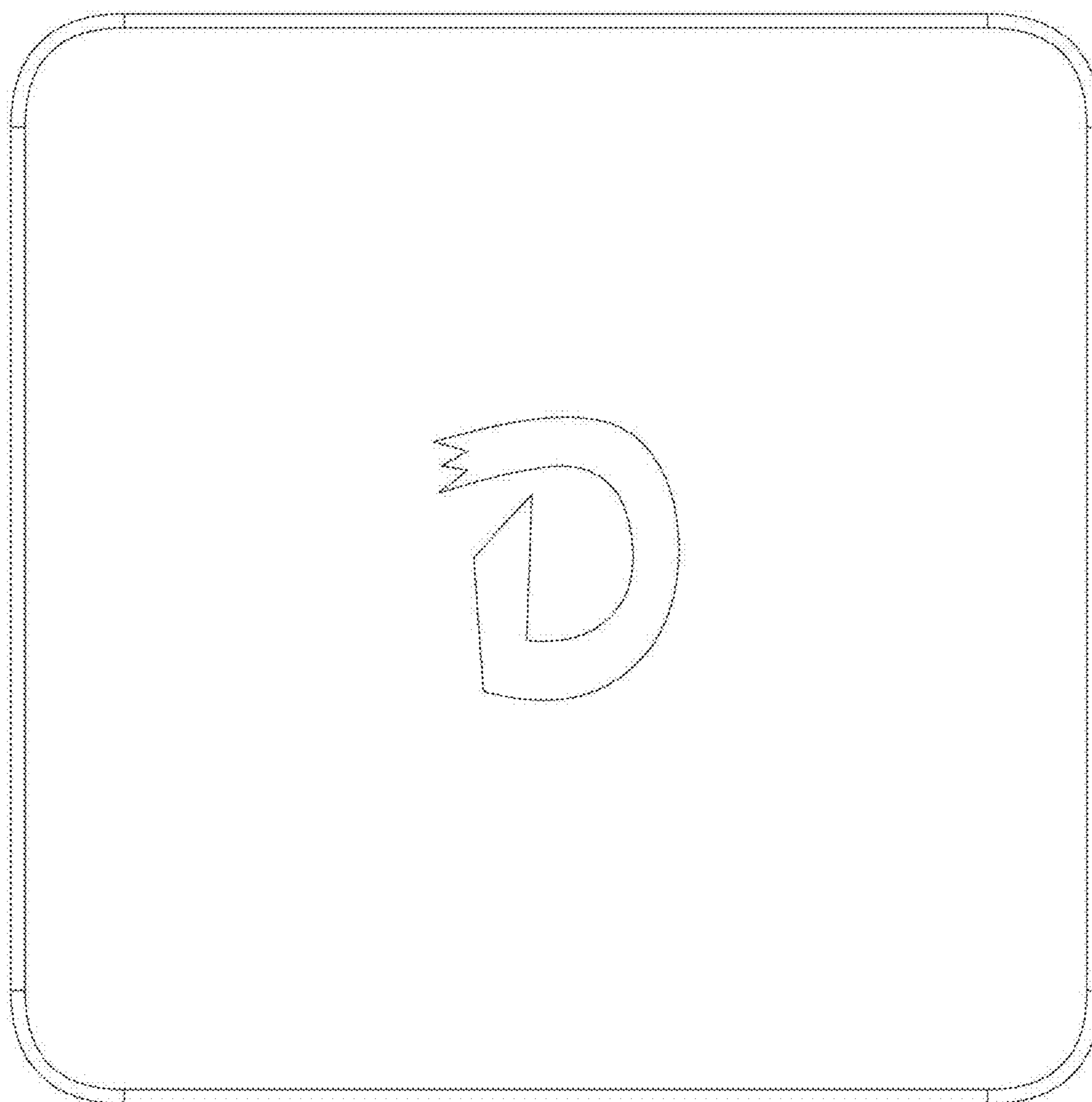

Fig. 29

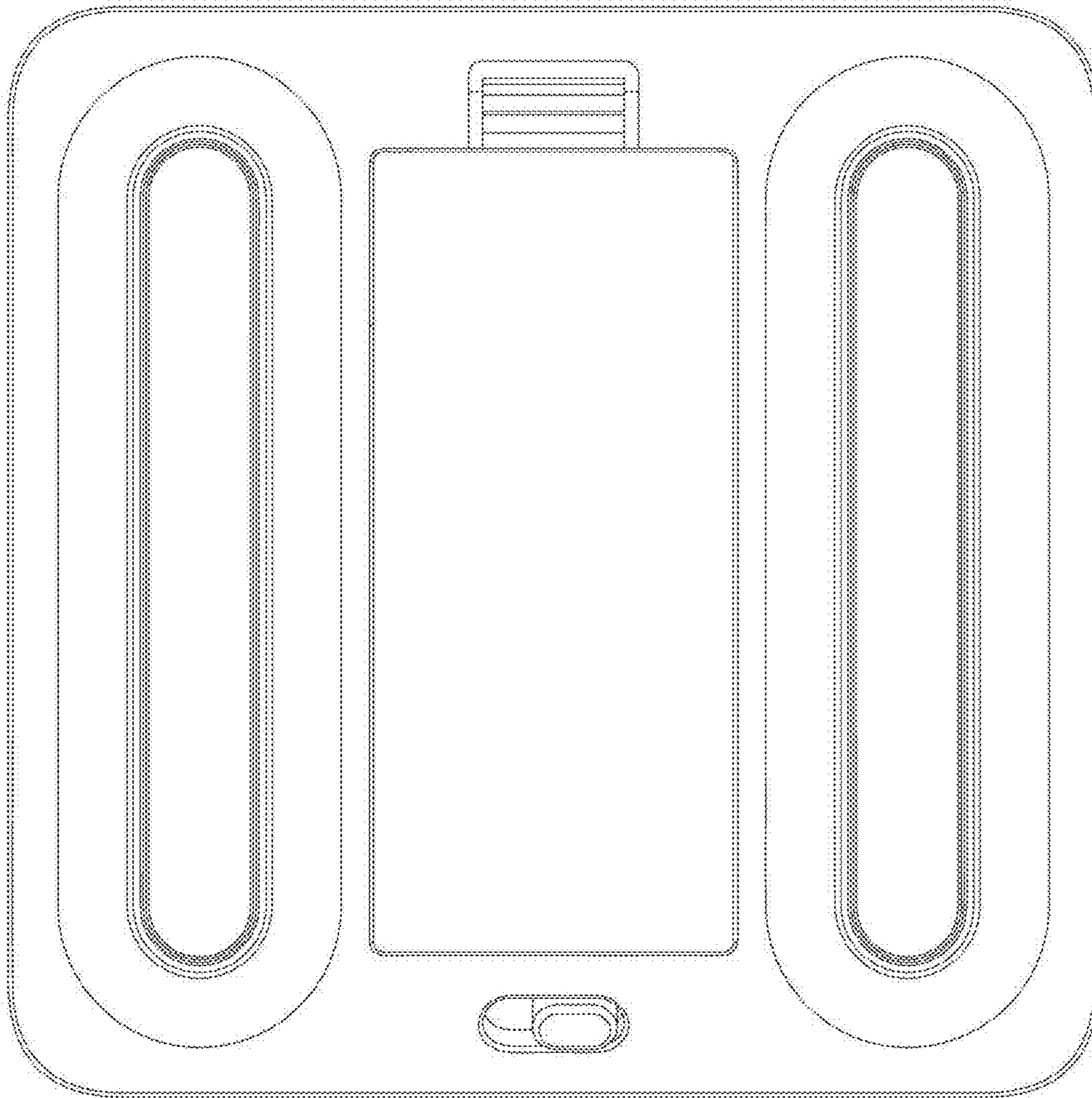

Fig. 30

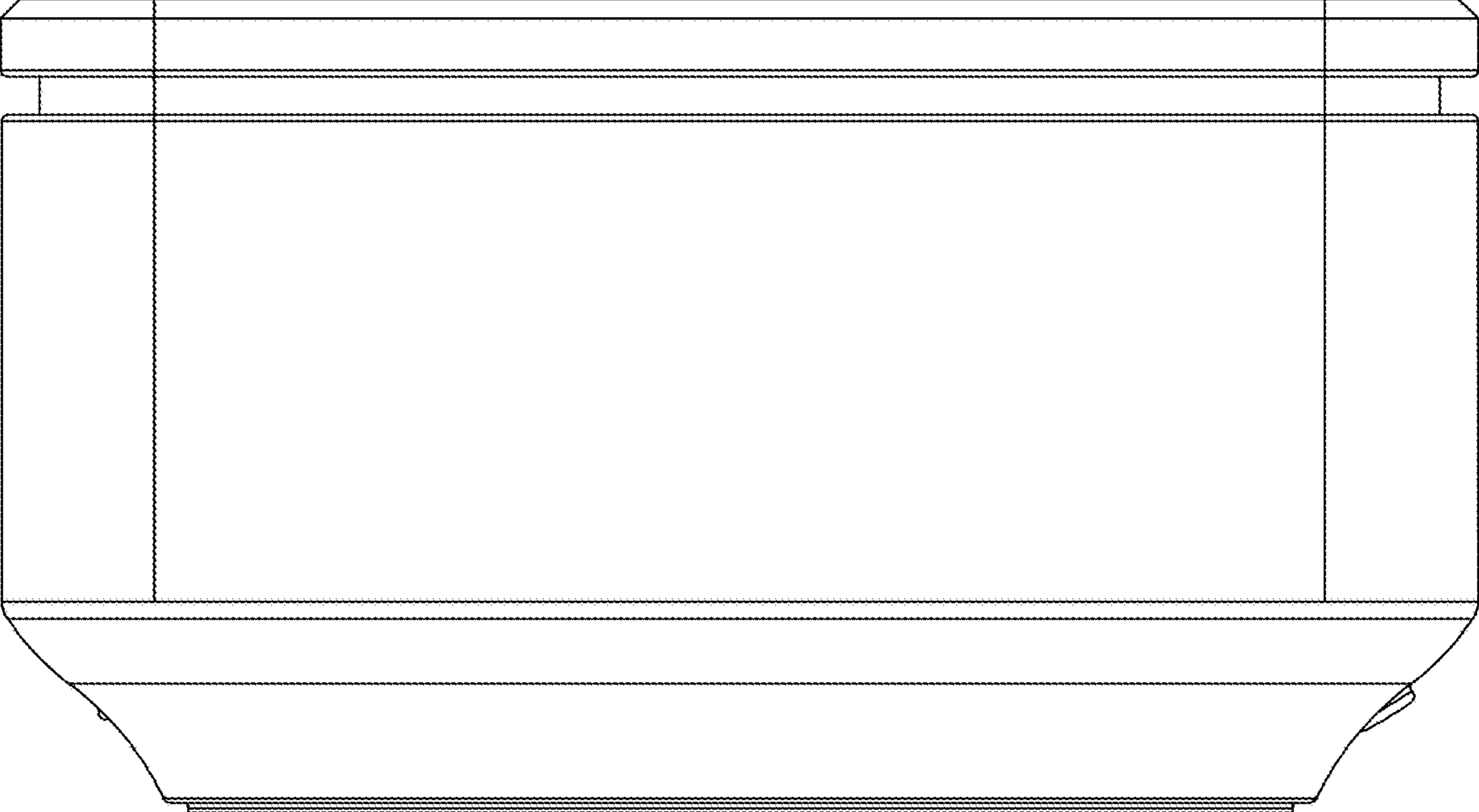

FIG. 31

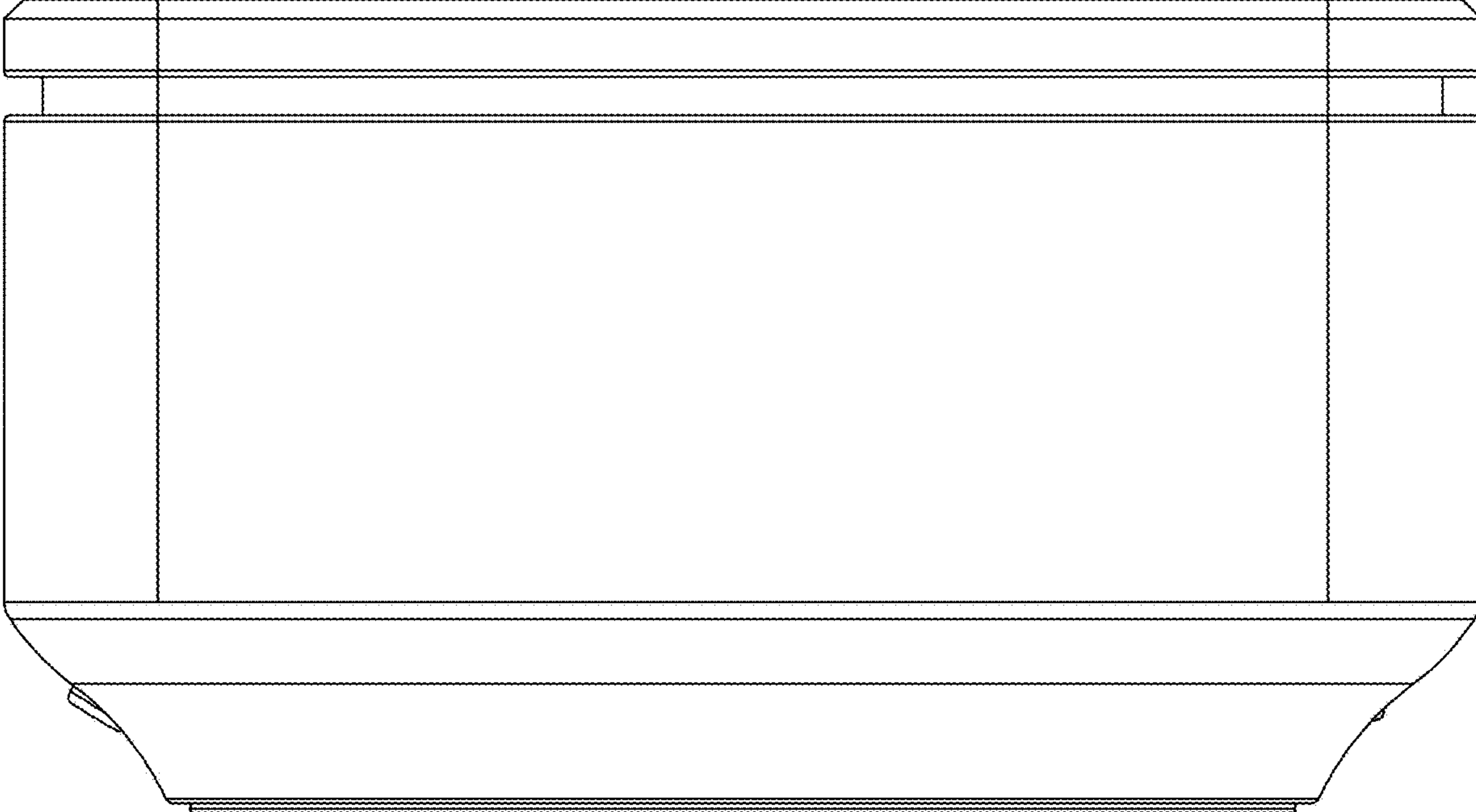
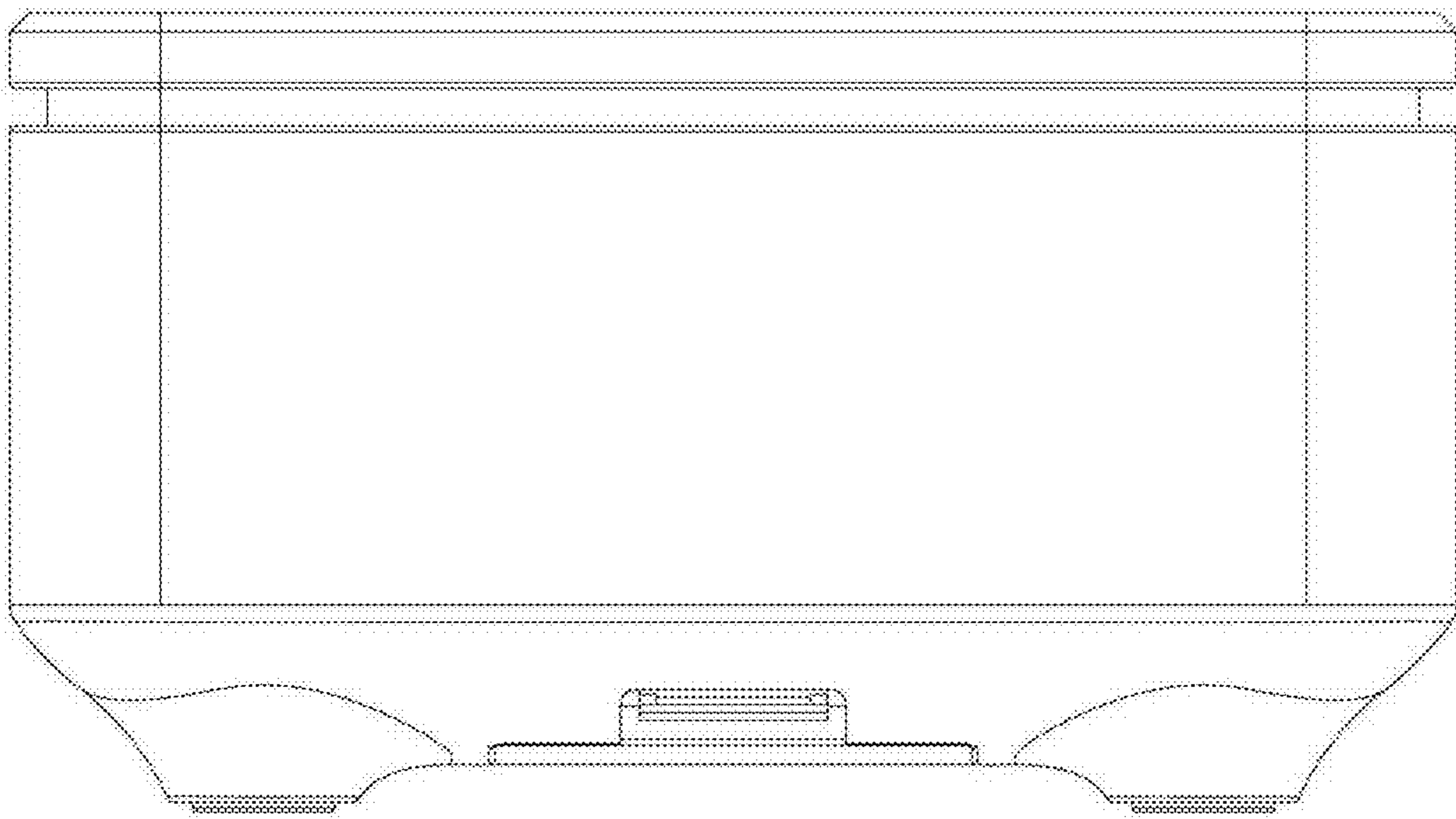

FIG. 32





**Fig. 33**

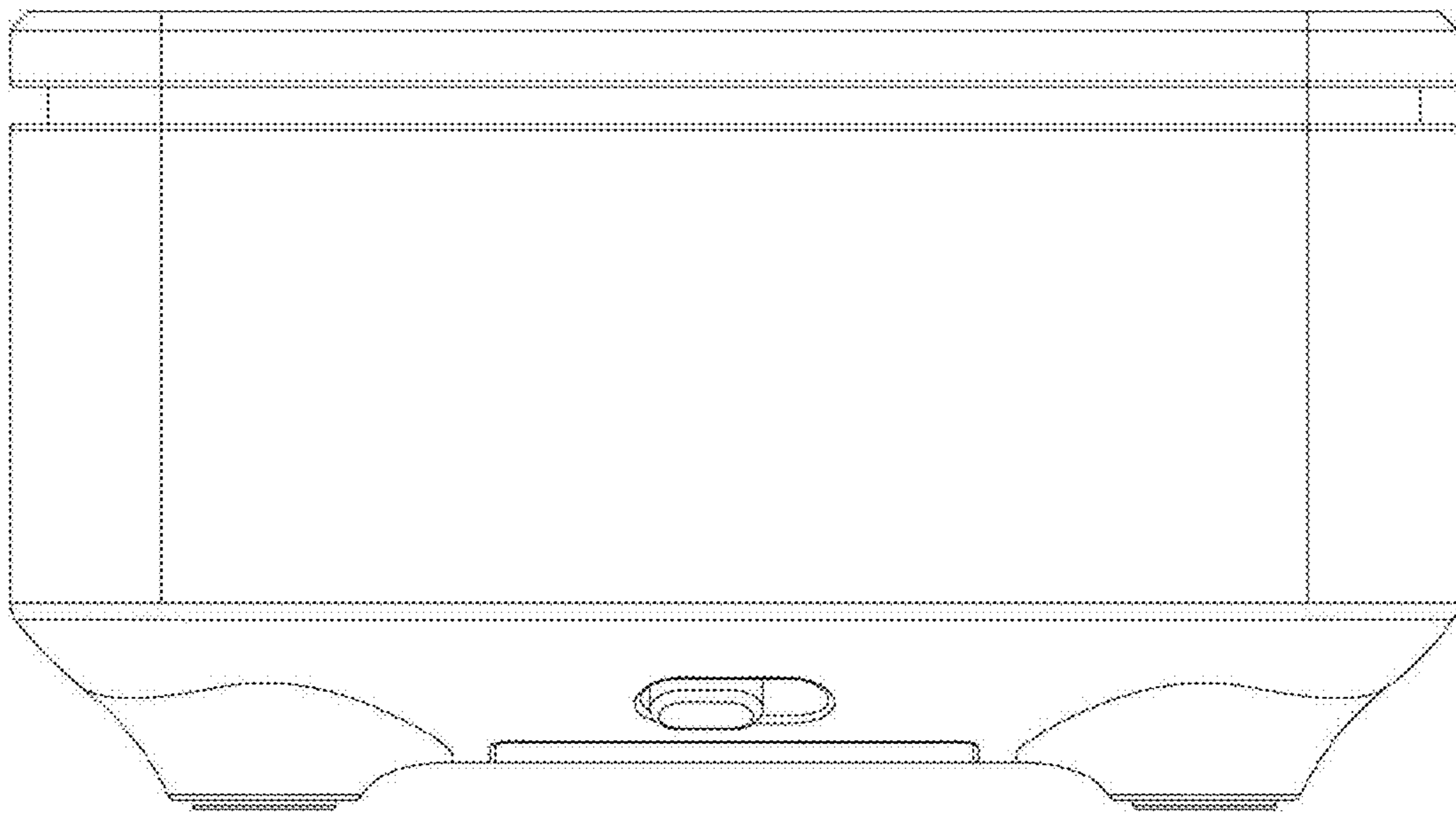

Fig. 34

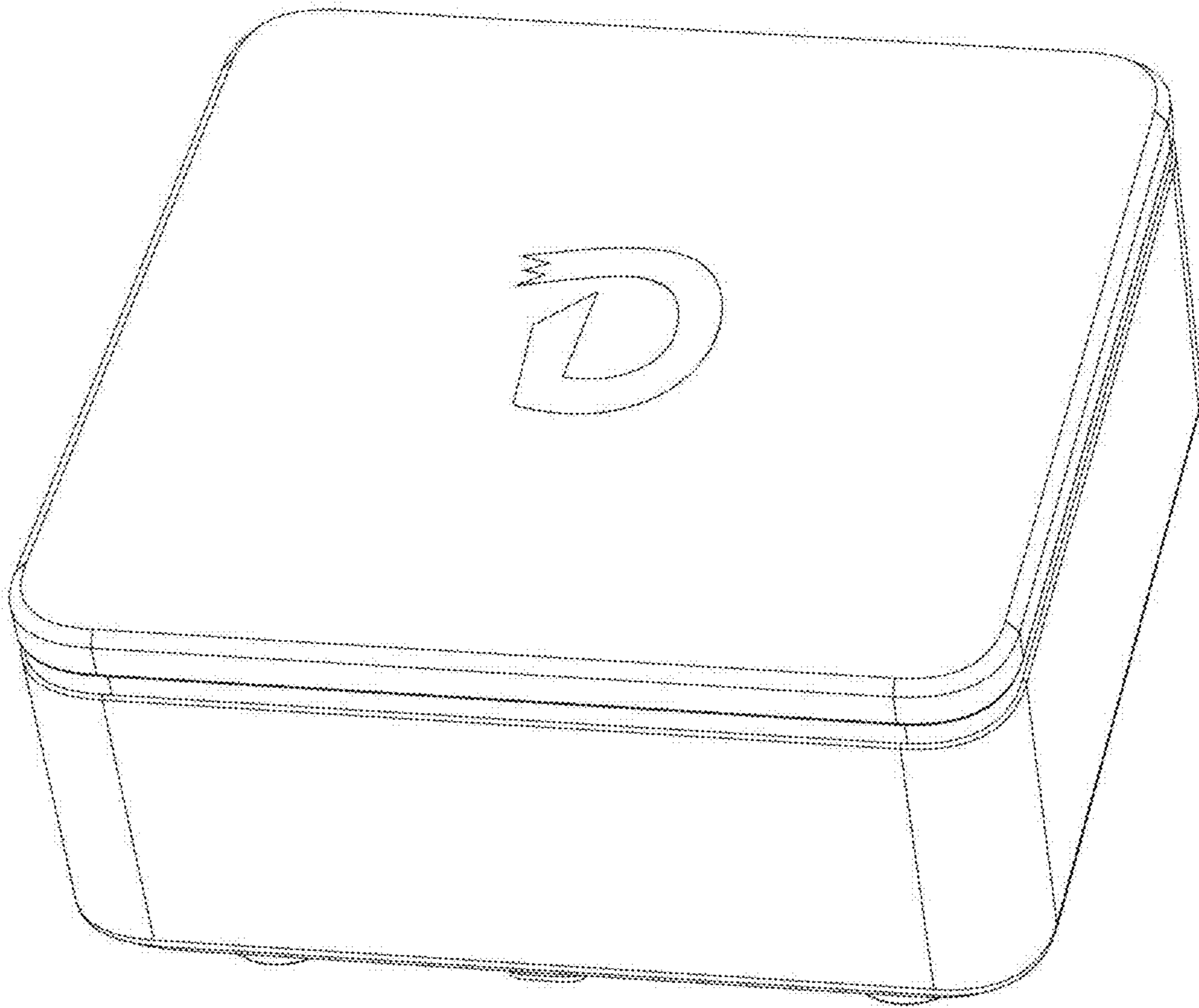

Fig. 35

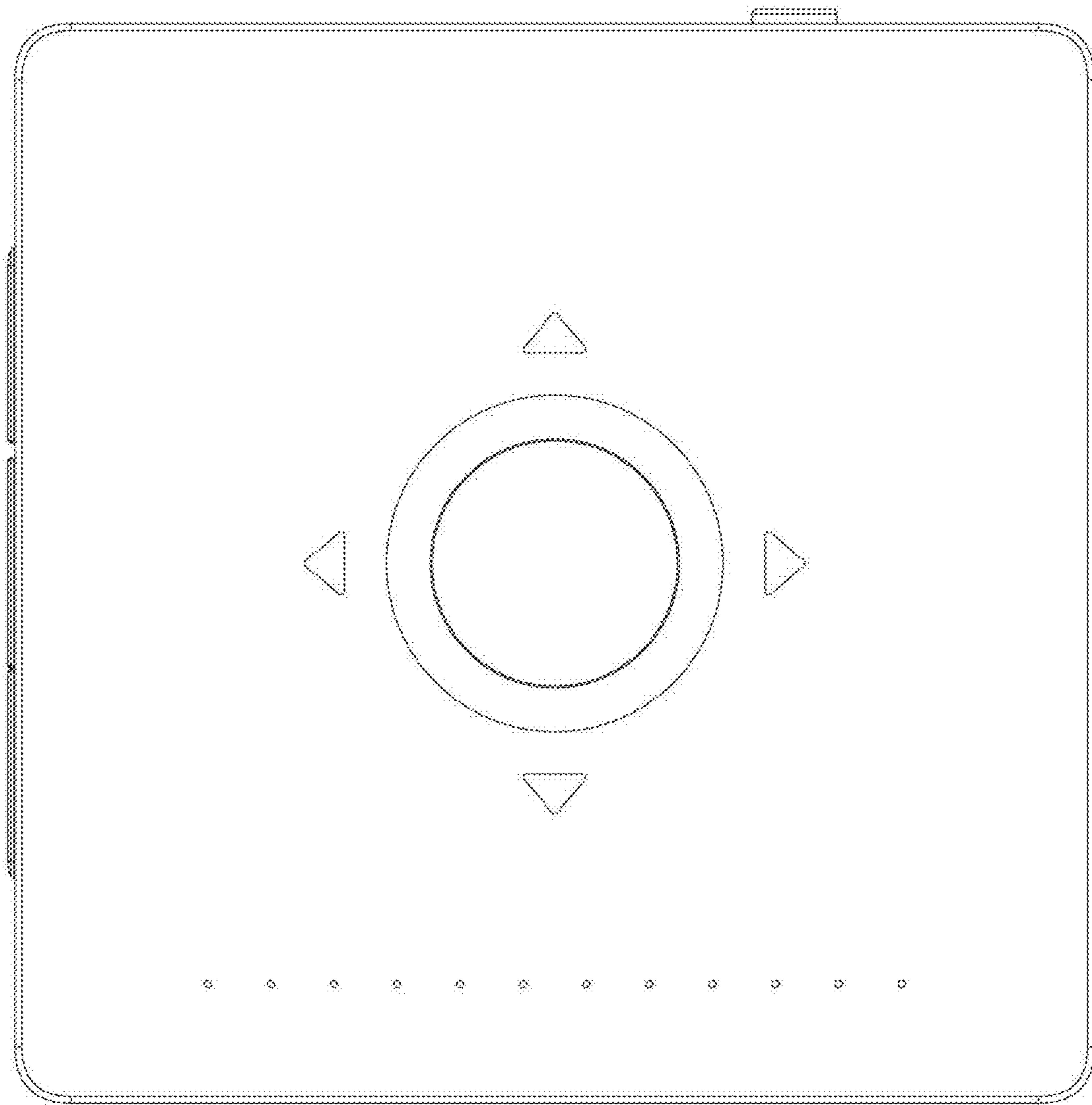

Fig. 36

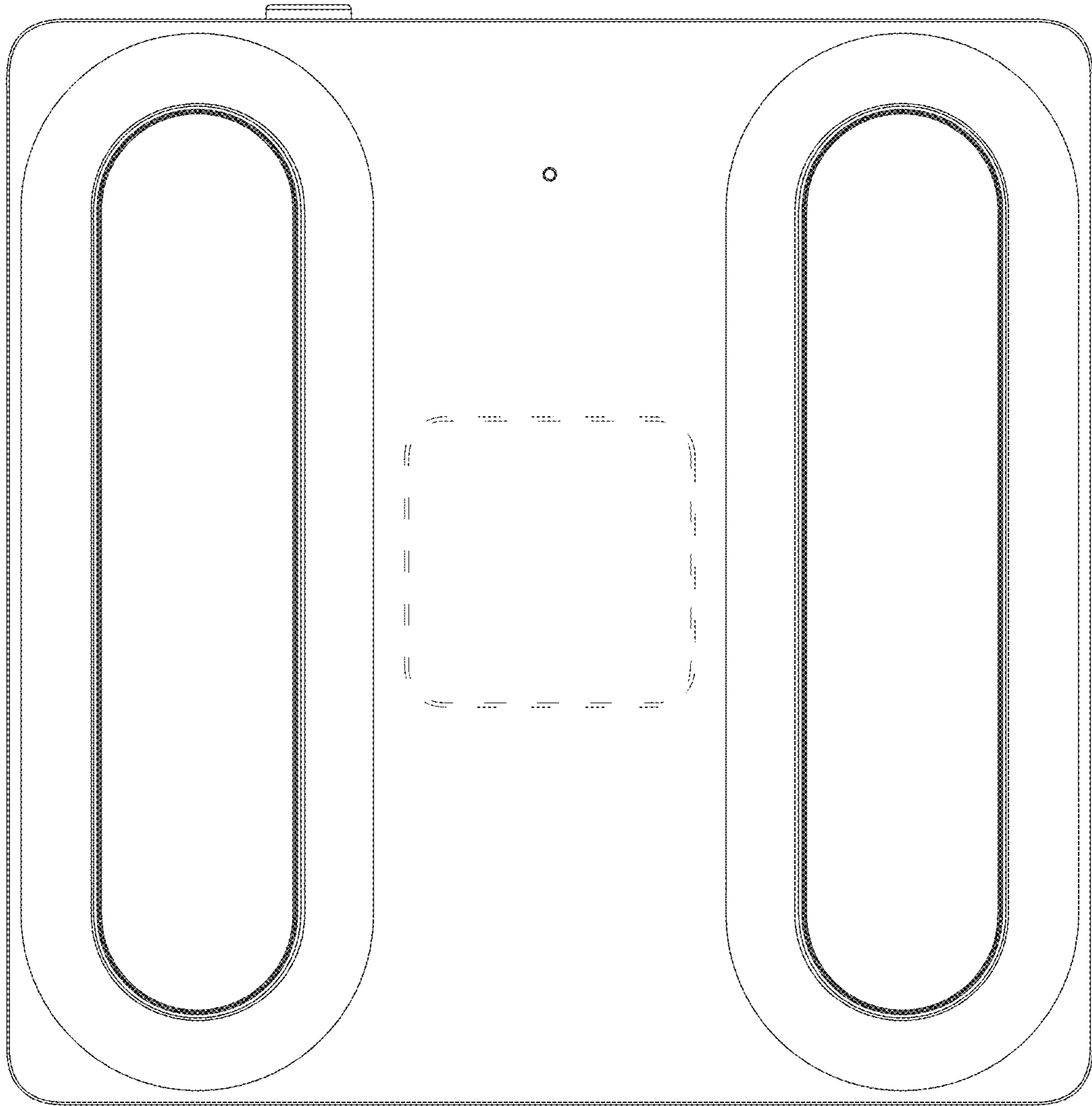

FIG. 37

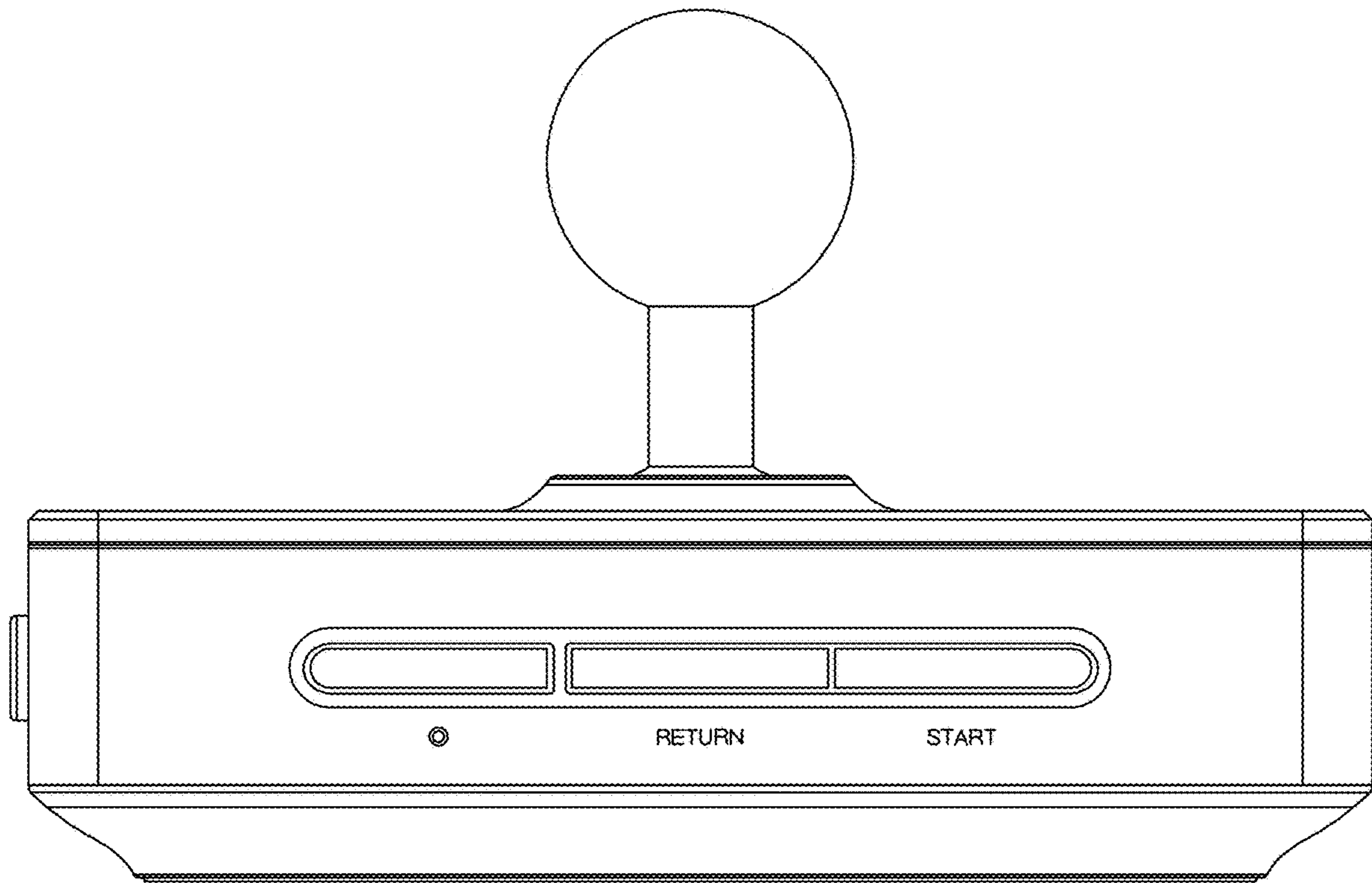

FIG. 38



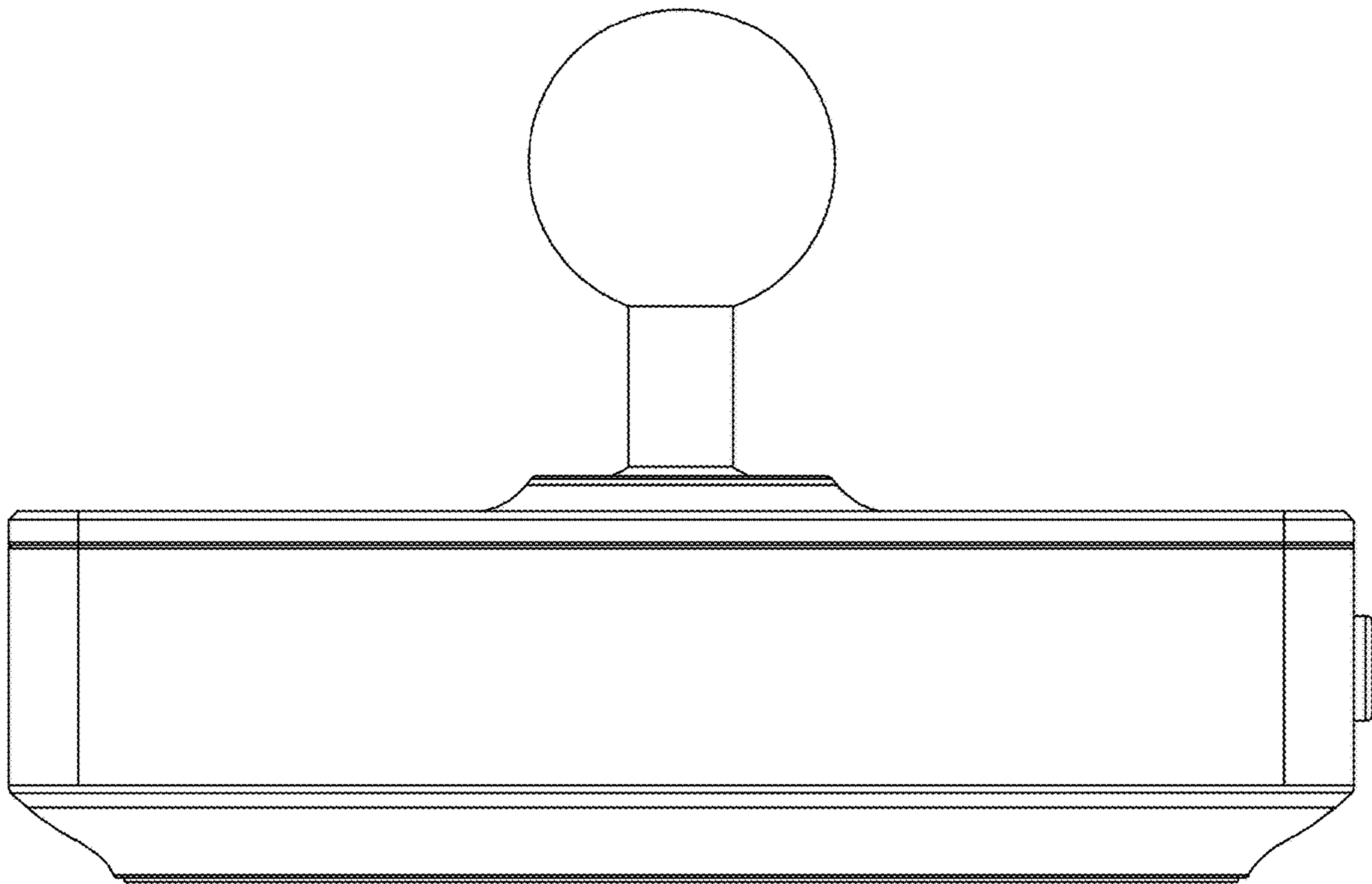

FIG. 39

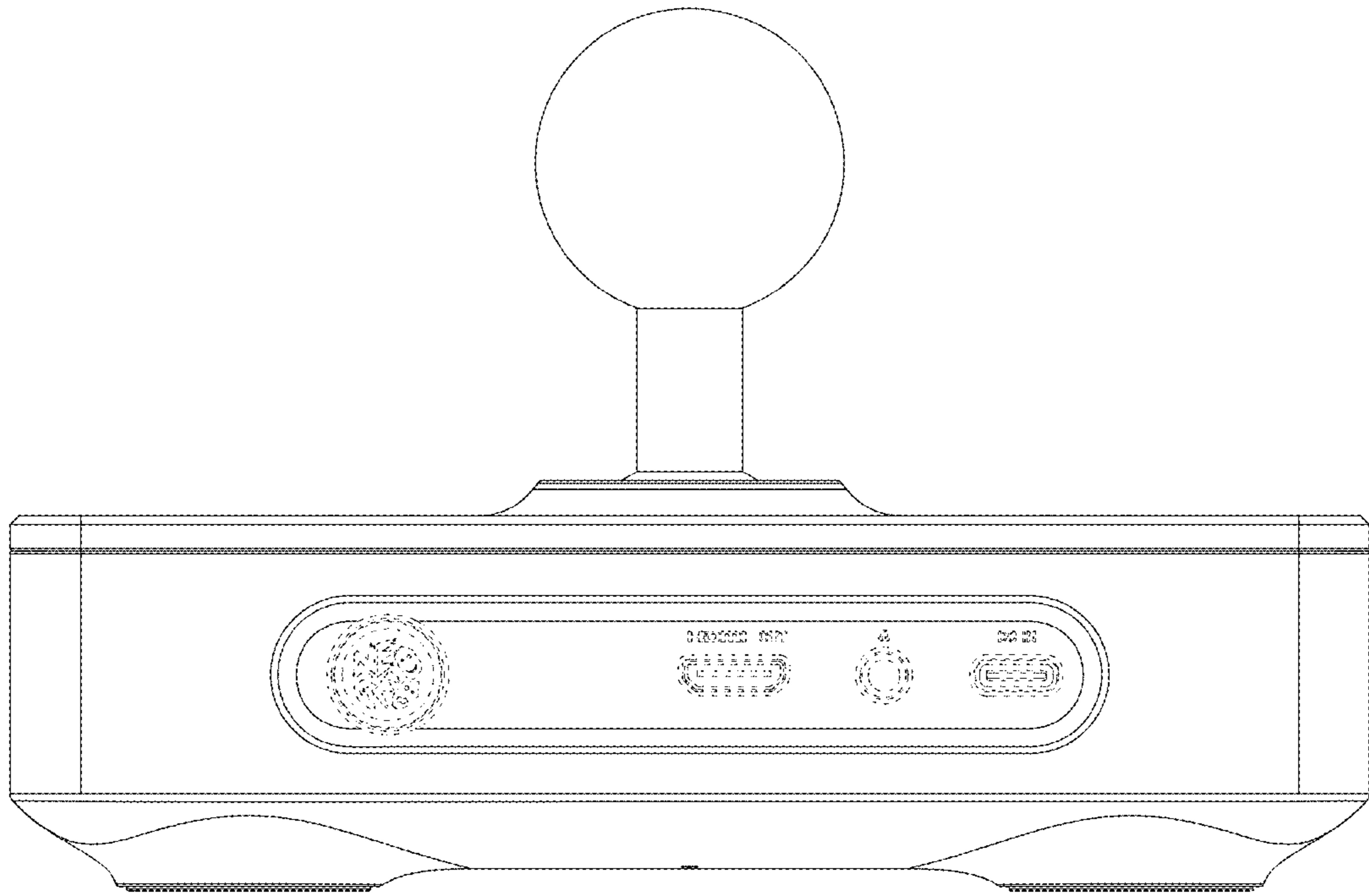

FIG. 40

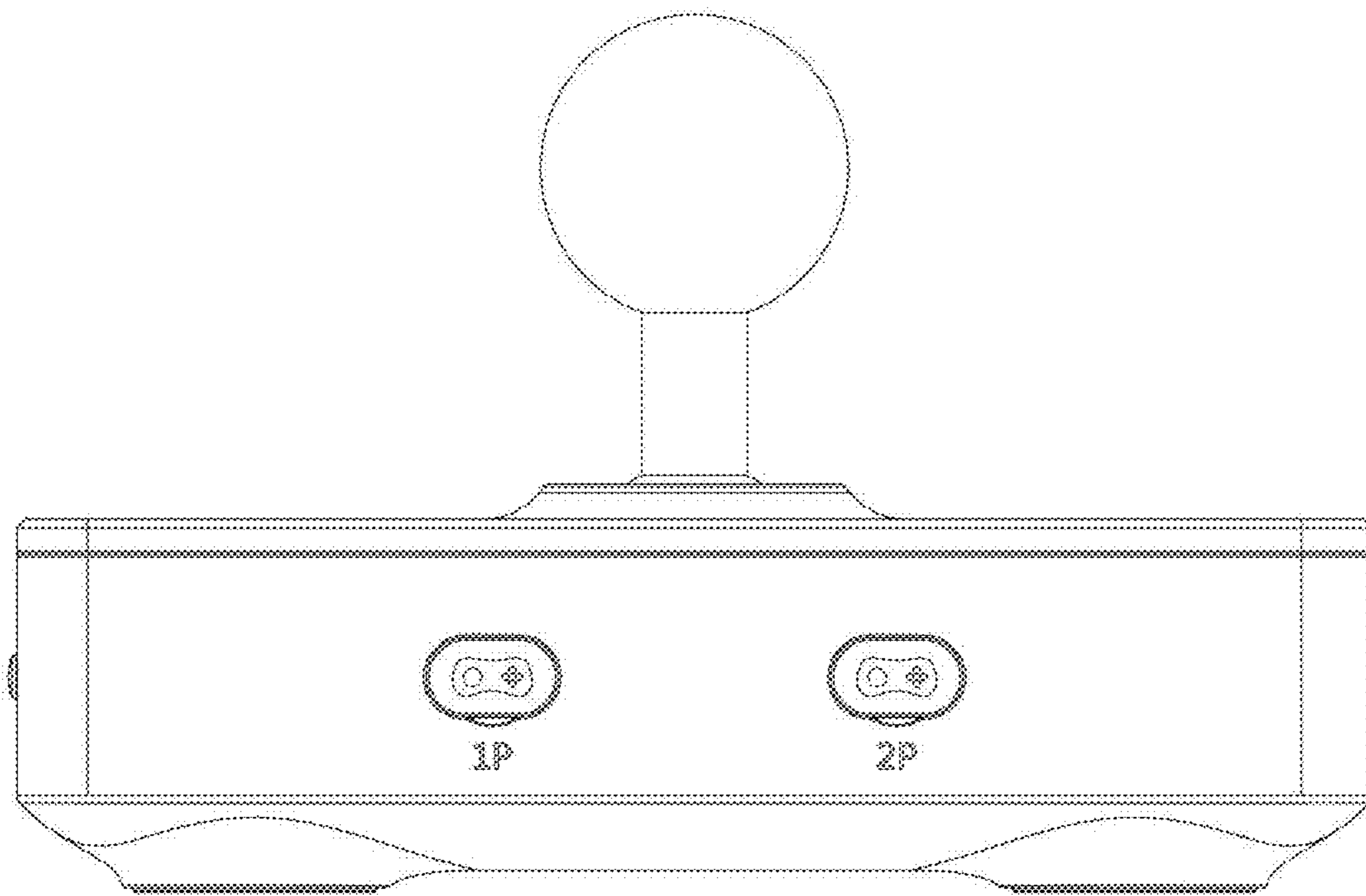

Fig. 41

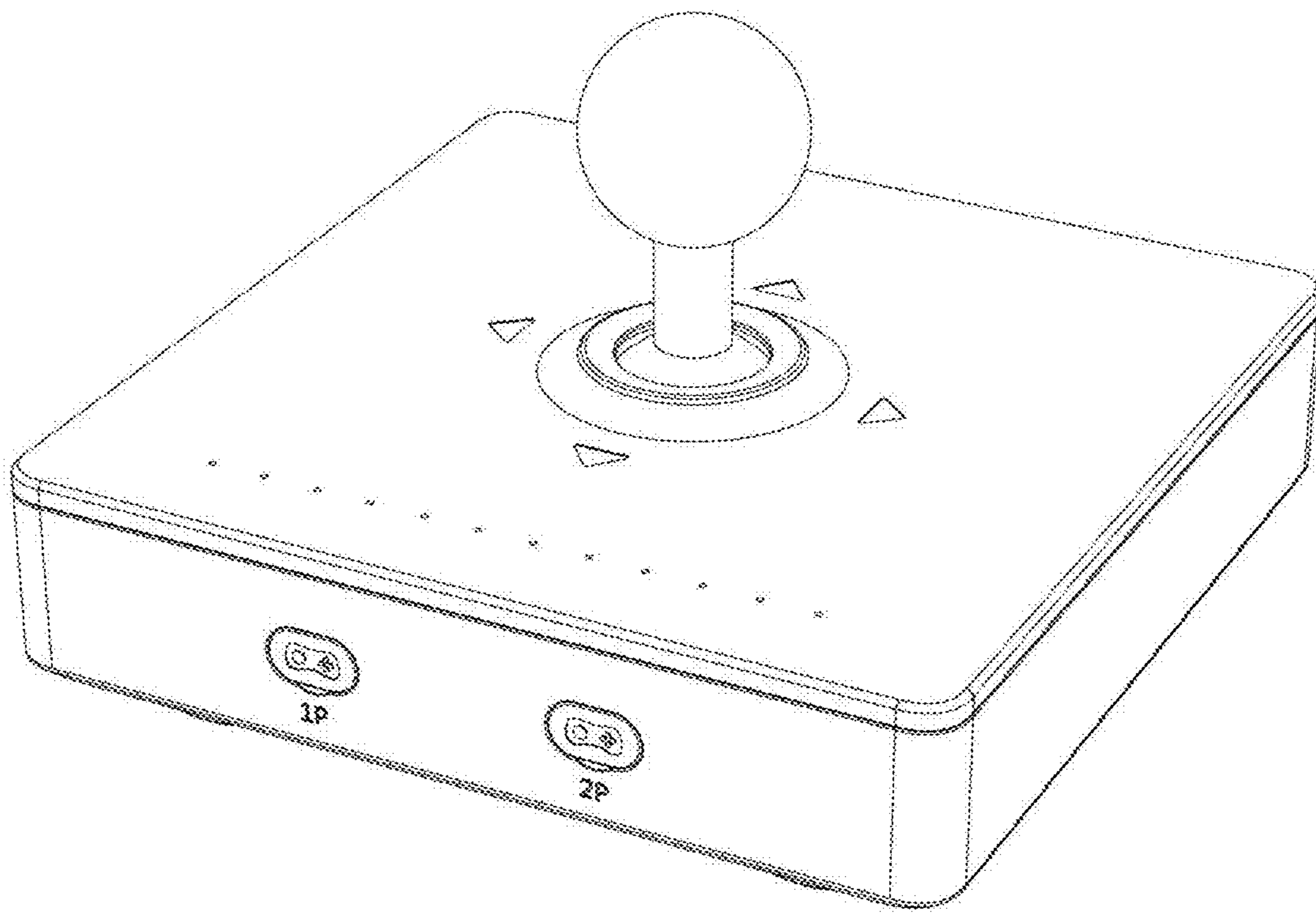

Fig. 42