



US00D963459S

(12) **United States Design Patent**
Habbouch

(10) **Patent No.:** **US D963,459 S**

(45) **Date of Patent:** **** Sep. 13, 2022**

(54) **DECORATIVE HANDLE**

(71) Applicant: **Pride Industrial, LLC**, Chino Hills, CA (US)

(72) Inventor: **Joseph Habbouch**, Chino Hills, CA (US)

(73) Assignee: **Pride Industrial, LLC**, Chino Hills, CA (US)

(**) Term: **15 Years**

(21) Appl. No.: **29/756,243**

(22) Filed: **Oct. 27, 2020**

(51) **LOC (13) Cl.** **08-06**

(52) **U.S. Cl.**
USPC **D8/321; D8/315**

(58) **Field of Classification Search**
USPC D8/315-316, 319-322
CPC A47B 95/02; Y10T 16/458; Y10T 16/462
See application file for complete search history.

(56) **References Cited**

U.S. PATENT DOCUMENTS

D387,265 S *	12/1997	Mattson	D8/316
D391,830 S *	3/1998	Carsello	D8/352
D395,812 S *	7/1998	Doughty	D23/250
D411,795 S *	7/1999	O'Neil	D8/310
D413,248 S *	8/1999	O'Neil	D8/317
D472,788 S *	4/2003	Zoerner	D8/321
D554,972 S *	11/2007	Pezzetta	D8/321
D587,982 S *	3/2009	Mattson	D8/317
D589,326 S *	3/2009	Mattson	D8/321
D597,820 S *	8/2009	Kirk	D8/317
D613,577 S *	4/2010	Koskela	D8/318
D642,445 S *	8/2011	Roe	D8/317
D649,428 S *	11/2011	Mattson	D8/317

D679,567 S *	4/2013	Ramsland	D8/316
D680,850 S *	4/2013	Jou	D8/315
D729,036 S *	5/2015	Han	D8/316
D779,914 S *	2/2017	Zimmer	D8/316
D821,175 S *	6/2018	Grasselli	D8/321
D833,253 S *	11/2018	Lowe	D8/316
D878,900 S *	3/2020	Warmenhoven	D8/316

OTHER PUBLICATIONS

“Amerock—Cabinet Pull—Golden Champagne”, May 16, 2011, blog.effortless-style.com, site visited Jan. 20, 2022: <https://www.amazon.com/Amerock-BP26201BBZ-Center-Center-Champagne/dp/B0051GU2TC> (Year: 2011).*

“Treat Yo Self: Greek Key Hardware”, Sep. 2018, blog.effortless-style.com, site visited Jan. 20, 2022: <https://blog.effortless-style.com/2018/09/treat-yo-self-greek-key-hardware/> (Year: 2018).*

* cited by examiner

Primary Examiner — Jack Reickel

Assistant Examiner — Michael A Kervin

(74) *Attorney, Agent, or Firm* — Varnum LLP

(57) **CLAIM**

I claim the ornamental design for a decorative handle, as shown and described.

DESCRIPTION

FIG. 1 is a perspective view of a decorative handle; FIG. 2 is a front view of the decorative handle of FIG. 1; FIG. 3 is a back view of the decorative handle of FIG. 1; FIG. 4 is a left view of the decorative handle of FIG. 1; FIG. 5 is a right view of the decorative handle of FIG. 1; FIG. 6 is a top view of the decorative handle of FIG. 1; and, FIG. 7 is a bottom view of the decorative handle of FIG. 1. All broken lines shown in the Figures illustrate portions of the article that form no part of the claimed design.

1 Claim, 2 Drawing Sheets

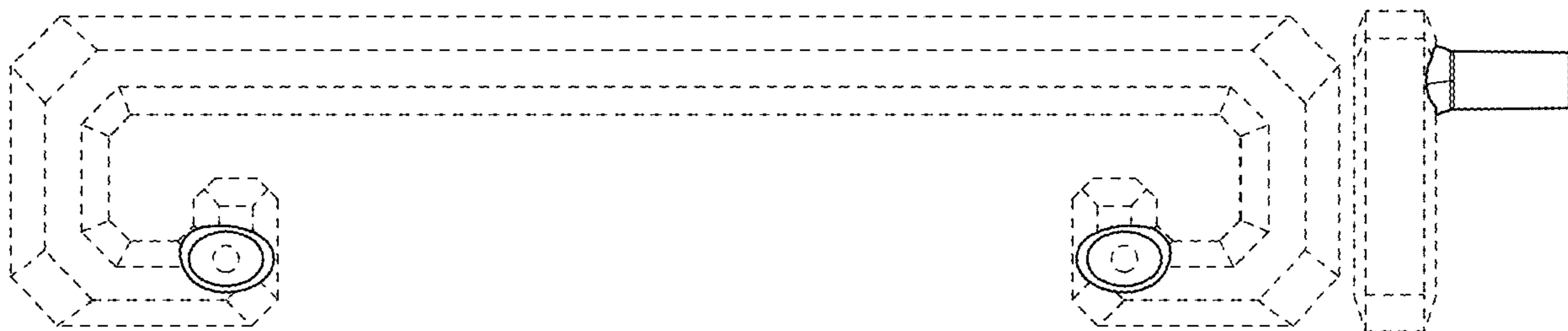

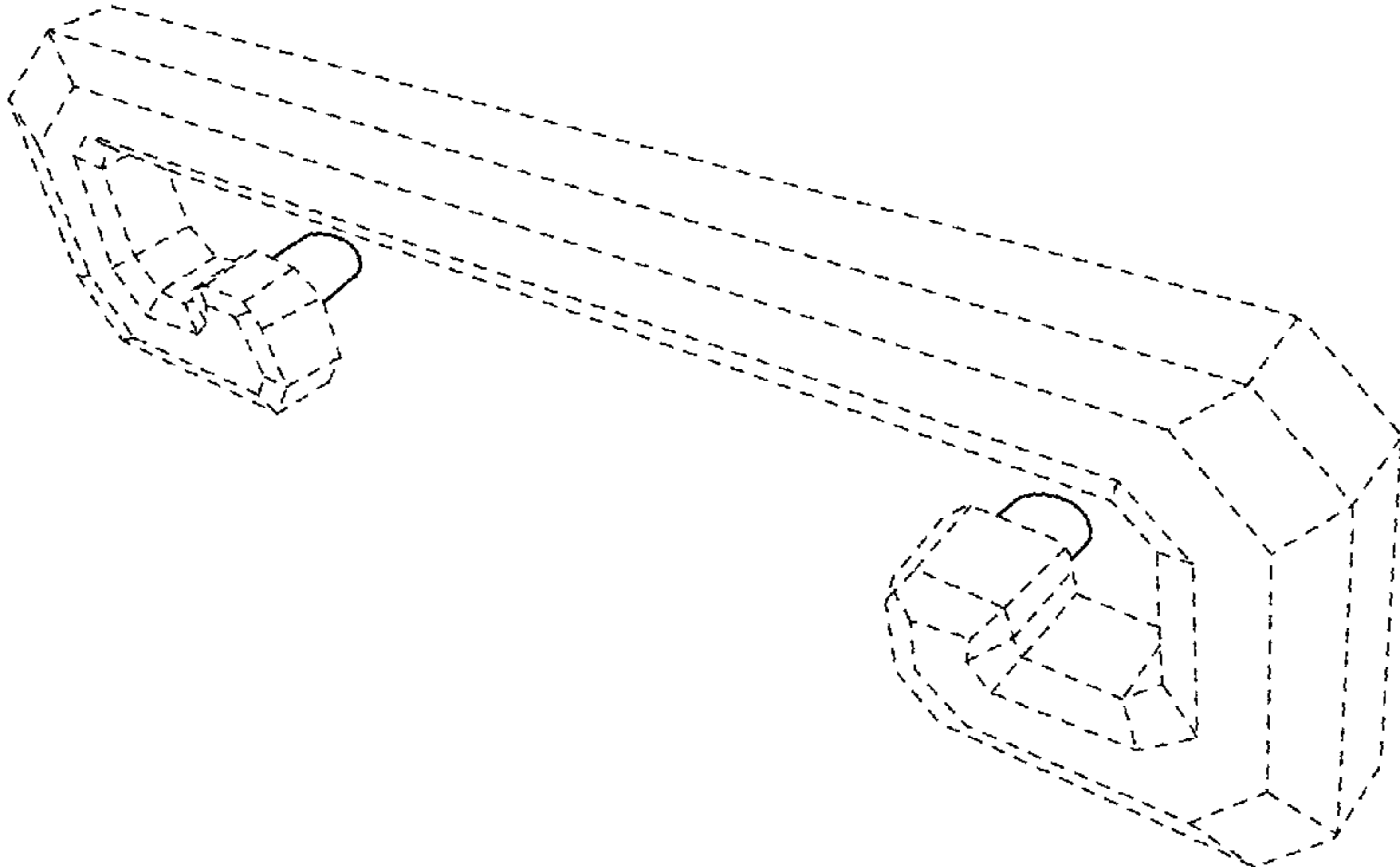

FIG. 1

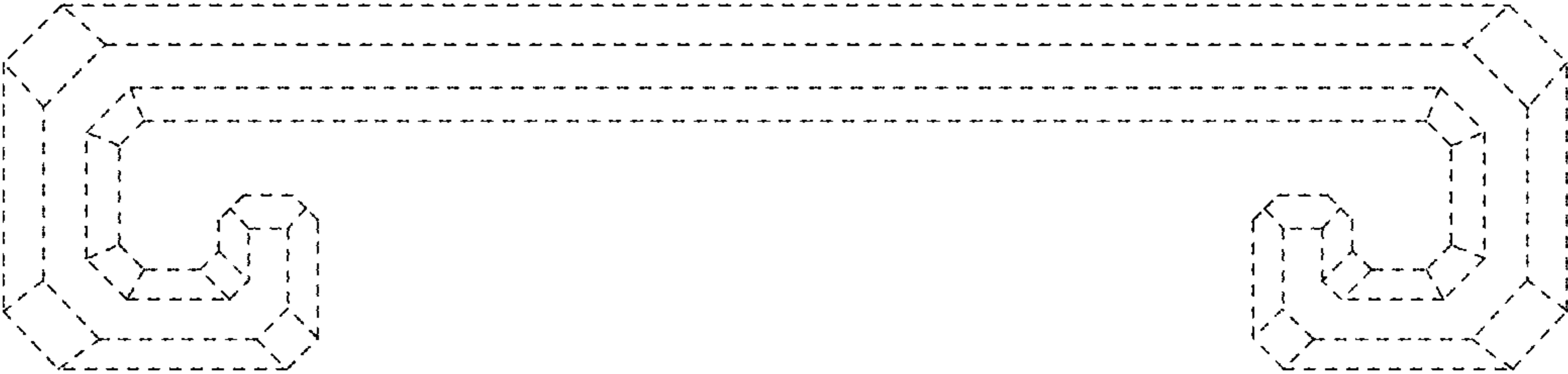

FIG. 2

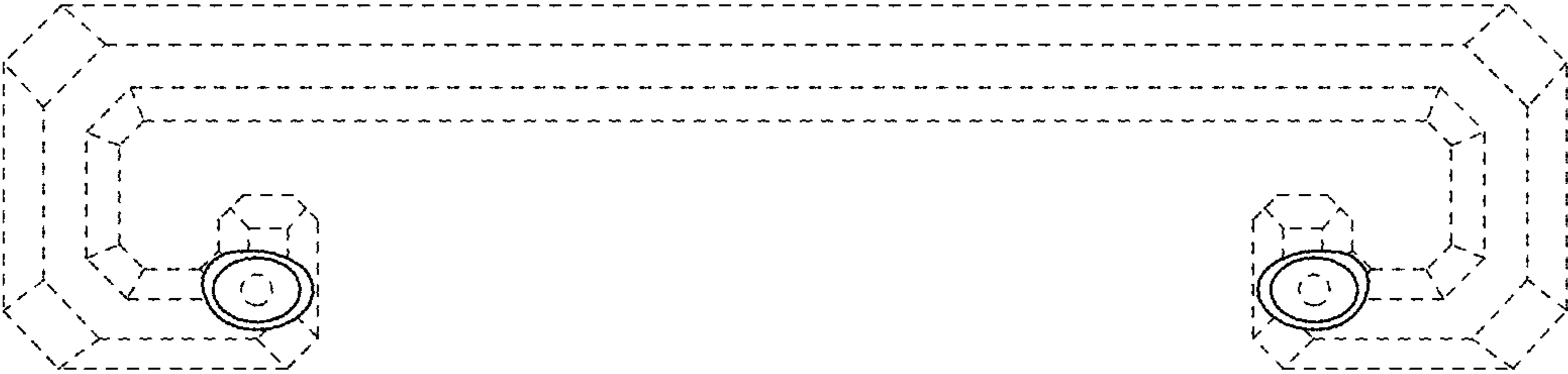

FIG. 3

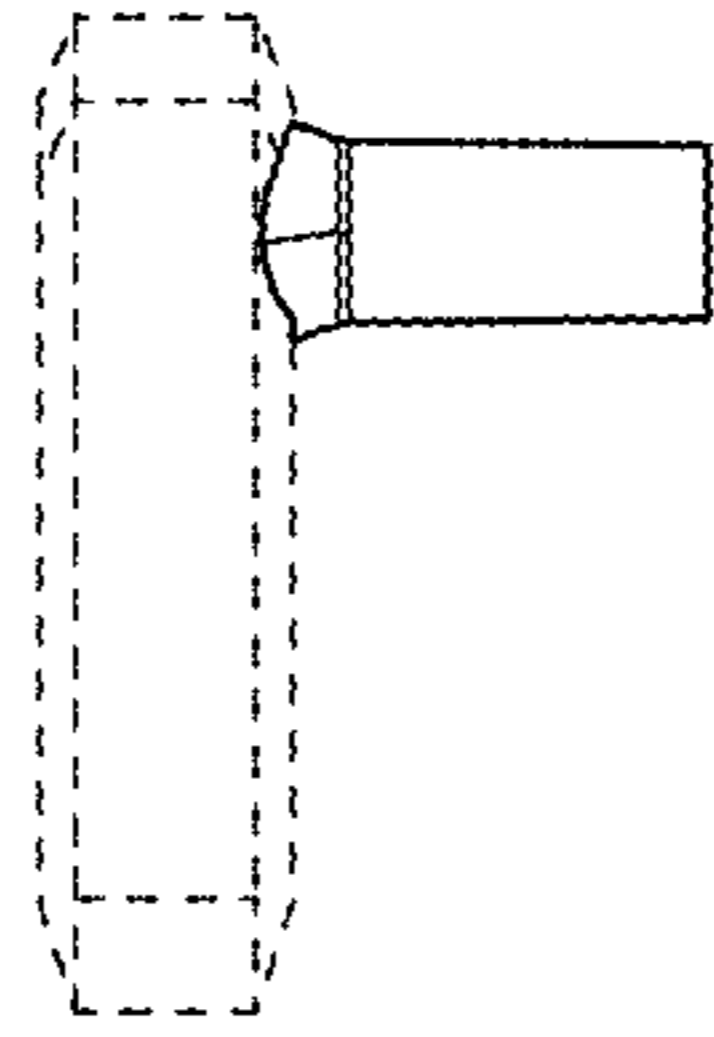

FIG. 4

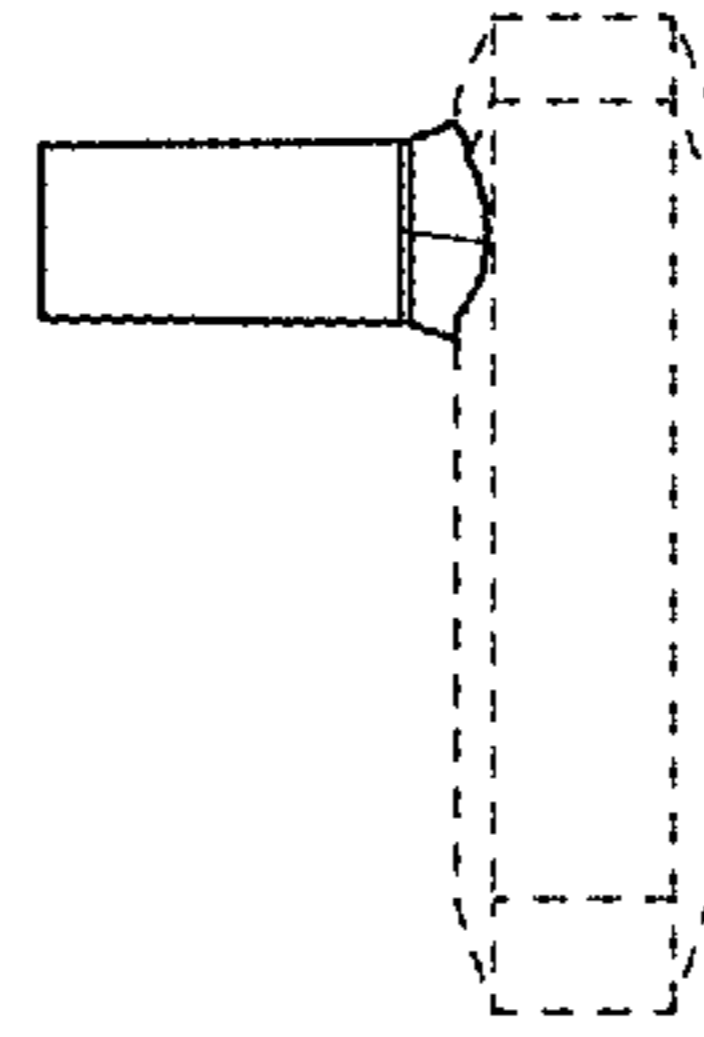

FIG. 5

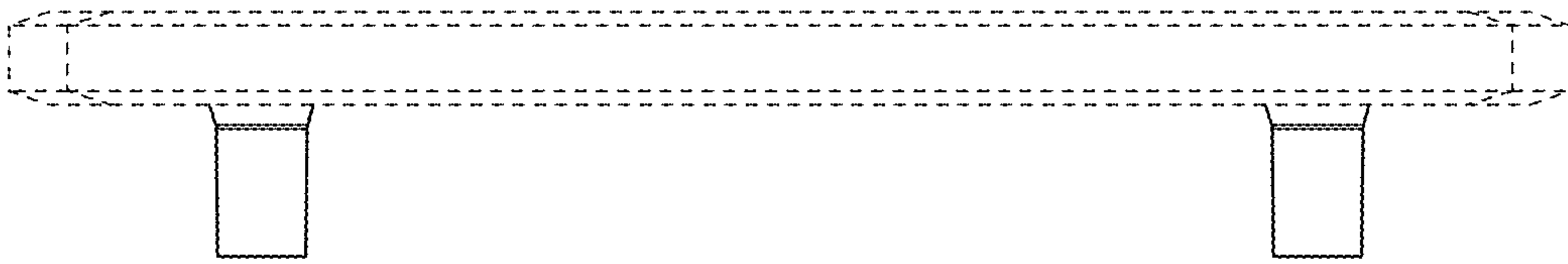

FIG. 6

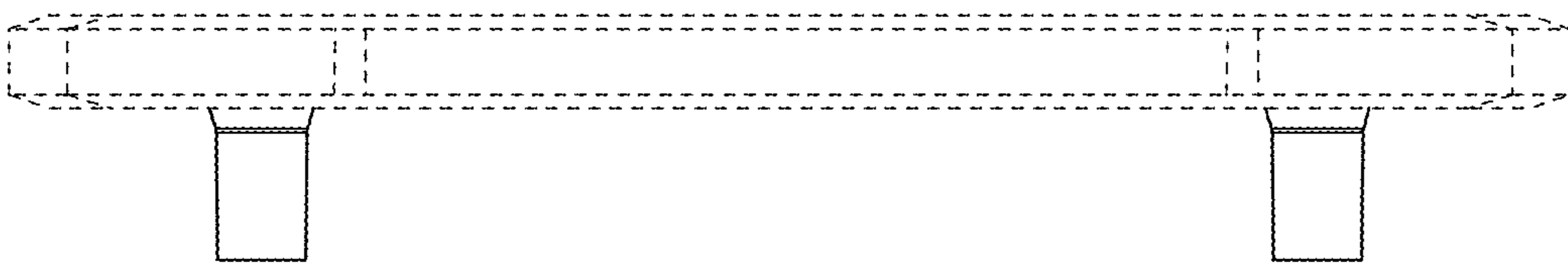

FIG. 7