



US00D963450S

(12) **United States Design Patent**
Chen

(10) **Patent No.:** **US D963,450 S**

(45) **Date of Patent:** **** Sep. 13, 2022**

(54) **CRIMPING TOOL**

(71) Applicant: **WENZHOU LISIDA TOOLS CO., LTD**, Yueqing (CN)

(72) Inventor: **Yaomeng Chen**, Yueqing (CN)

(73) Assignee: **WENZHOU LISIDA TOOLS CO., LTD**, Yueqing (CN)

(**) Term: **15 Years**

(21) Appl. No.: **29/804,219**

(22) Filed: **Aug. 19, 2021**

(51) **LOC (13) Cl.** **08-05**

(52) **U.S. Cl.**
USPC **D8/52**

(58) **Field of Classification Search**
USPC D8/51-60
CPC H01R 43/042; H01R 43/0424
See application file for complete search history.

(56) **References Cited**

U.S. PATENT DOCUMENTS

2,727,416	A *	12/1955	Labuza	H01R 43/0424 72/402
D205,630	S *	8/1966	Kremkau, Jr.	D8/56
D465,140	S *	11/2002	Cheng	D8/51
D558,014	S *	12/2007	Hutchfield	D8/52
7,997,116	B2 *	8/2011	Norin	B25B 27/146 72/409.11
8,474,299	B2 *	7/2013	Lutze	H01R 43/0424 72/402
9,242,349	B2 *	1/2016	Battenfeld	H01R 43/0424
9,381,631	B2 *	7/2016	Ullbors	B25B 27/146
D823,084	S *	7/2018	Graykowski	D8/52
D838,564	S *	1/2019	Mueller	D8/52

D901,271 S * 11/2020 Liao D8/52
D906,075 S * 12/2020 Liao D8/52
2015/0288124 A1 * 10/2015 Dierks H01R 43/0424
29/751

* cited by examiner

Primary Examiner — Deanna L Pratt

(57) **CLAIM**

The ornamental design for a crimping tool, as shown and described.

DESCRIPTION

FIG. 1 is a perspective view of a first embodiment of a crimping tool showing my new design; FIG. 2 is another perspective view thereof; FIG. 3 is a front elevational view thereof; FIG. 4 is a rear elevational view thereof; FIG. 5 is a left side elevational view thereof; FIG. 6 is a right side elevational view thereof; FIG. 7 is a top plan view thereof; FIG. 8 is a bottom plan view thereof; and FIG. 9 is an enlarged view of portion 9 shown in FIG. 1. FIG. 10 is a perspective view of a second embodiment of the crimping tool; FIG. 11 is another perspective view thereof; FIG. 12 is a front elevational view thereof; FIG. 13 is a rear elevational view thereof; FIG. 14 is a left side elevational view thereof; FIG. 15 is a right side elevational view thereof; FIG. 16 is a top plan view thereof; FIG. 17 is a bottom plan view thereof; and, FIG. 18 is an enlarged view of portion 18 shown in FIG. 10. The dash-dash broken lines in the drawings depict portions of the crimping tool that form no part of the claimed design. The dot-dash broken lines represent boundaries of the enlarged portions and form no part of the claimed design.

1 Claim, 18 Drawing Sheets

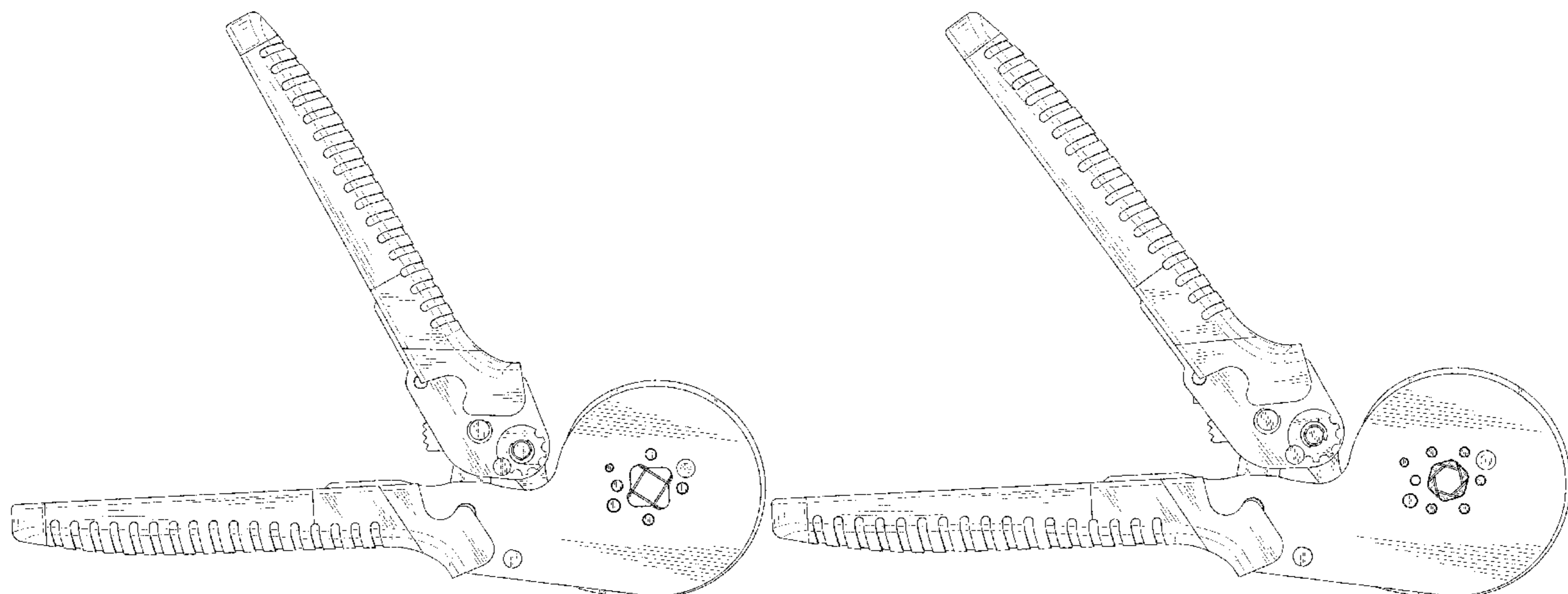

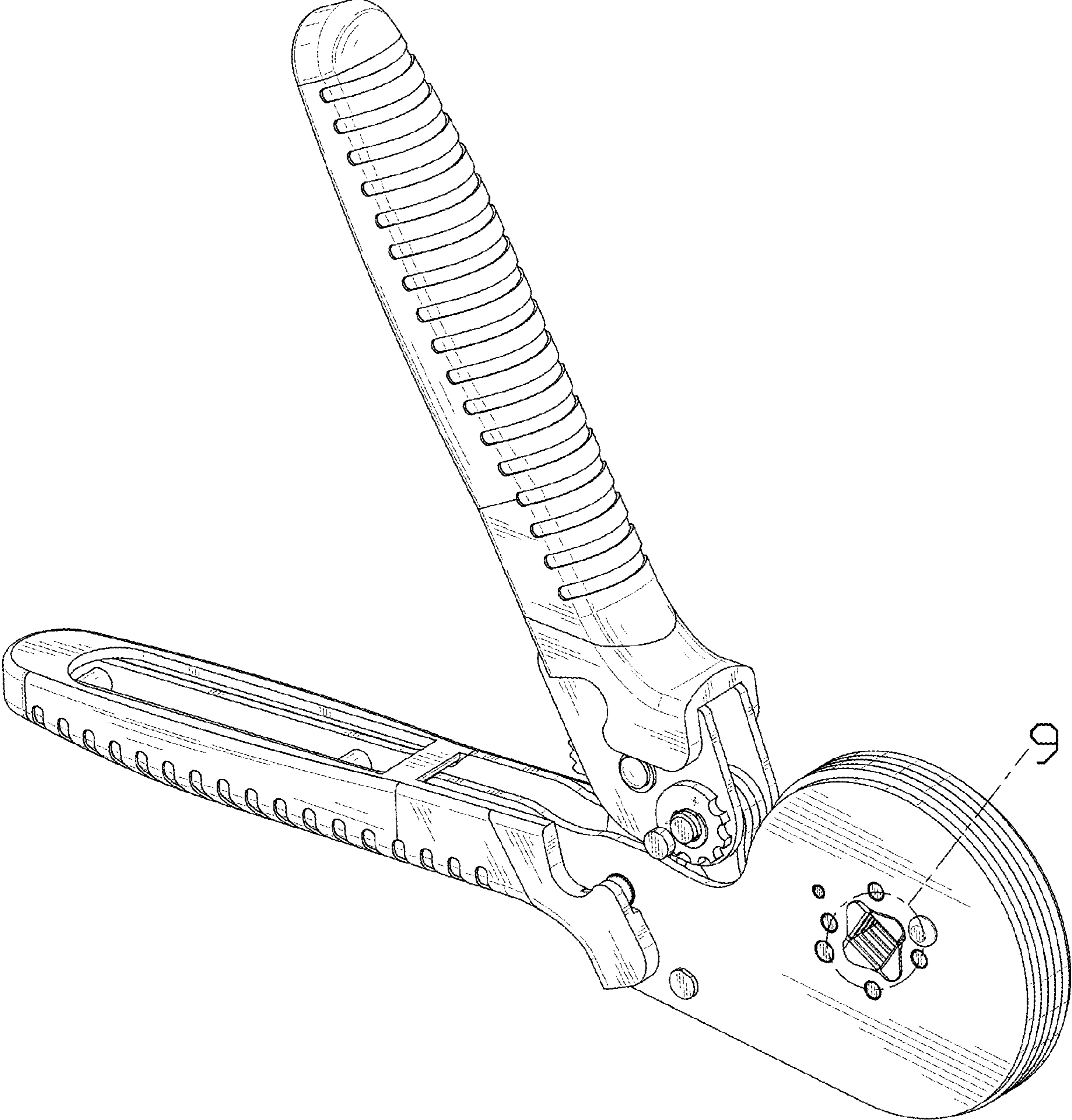

FIG. 1

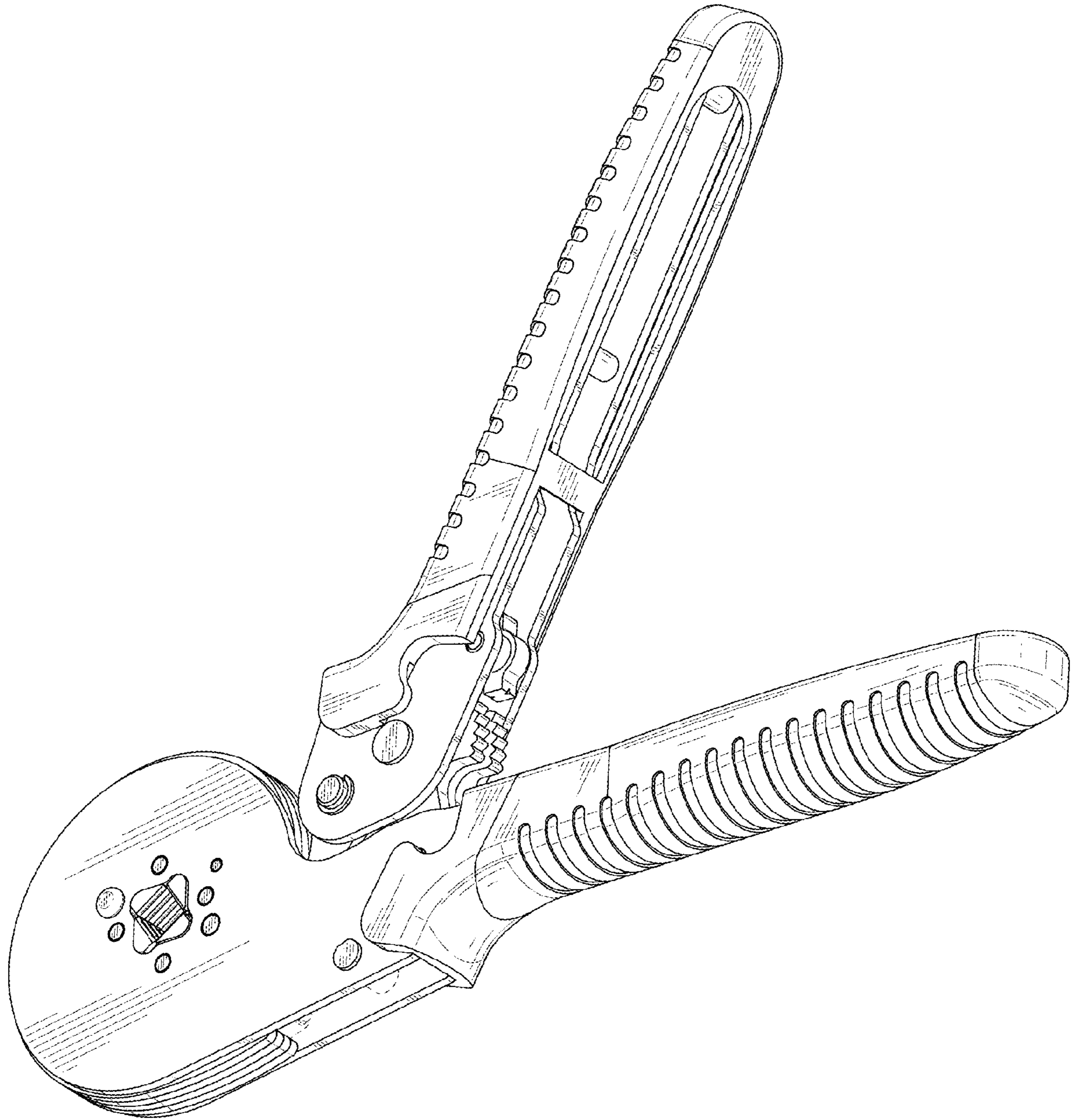

FIG. 2

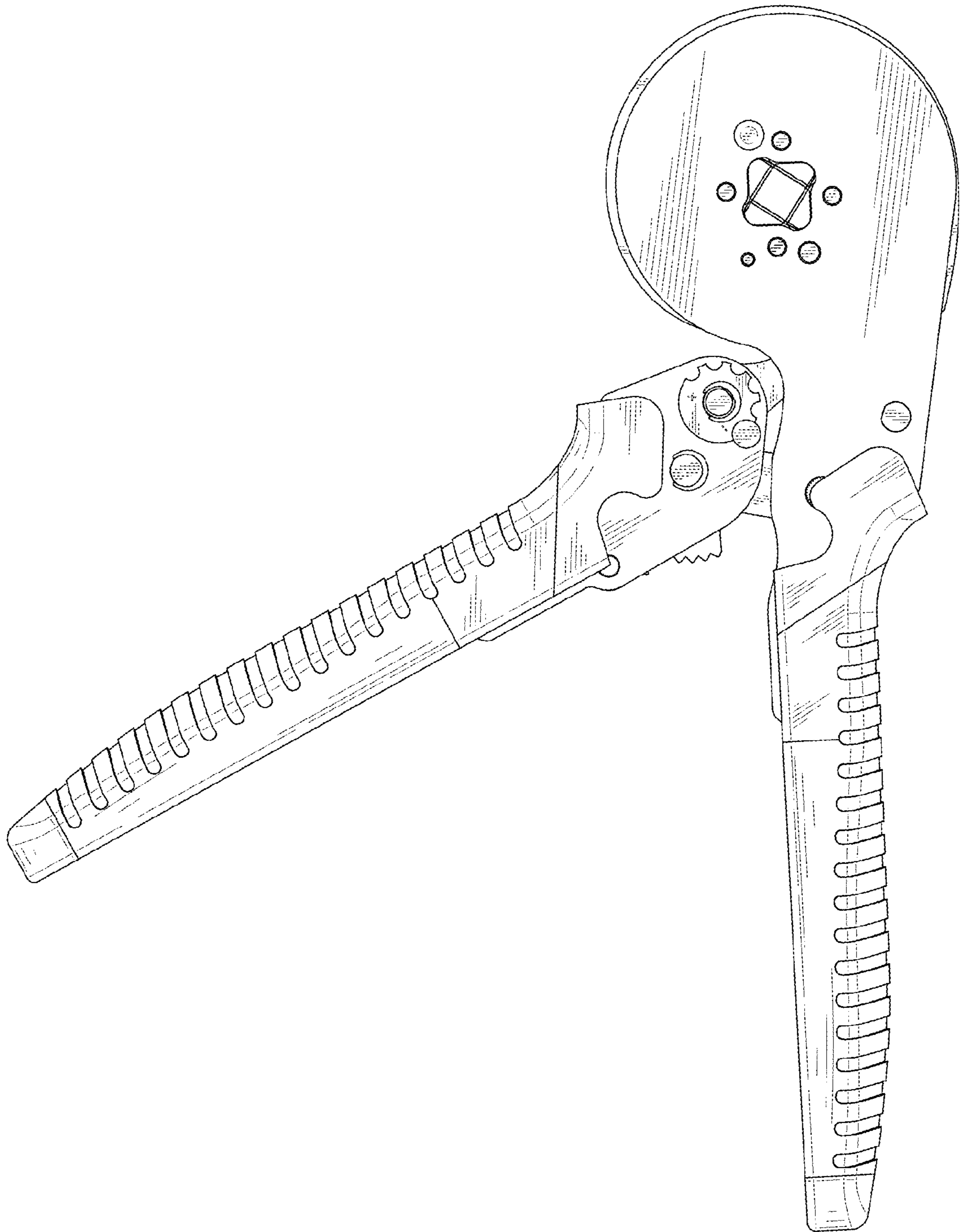

FIG. 3

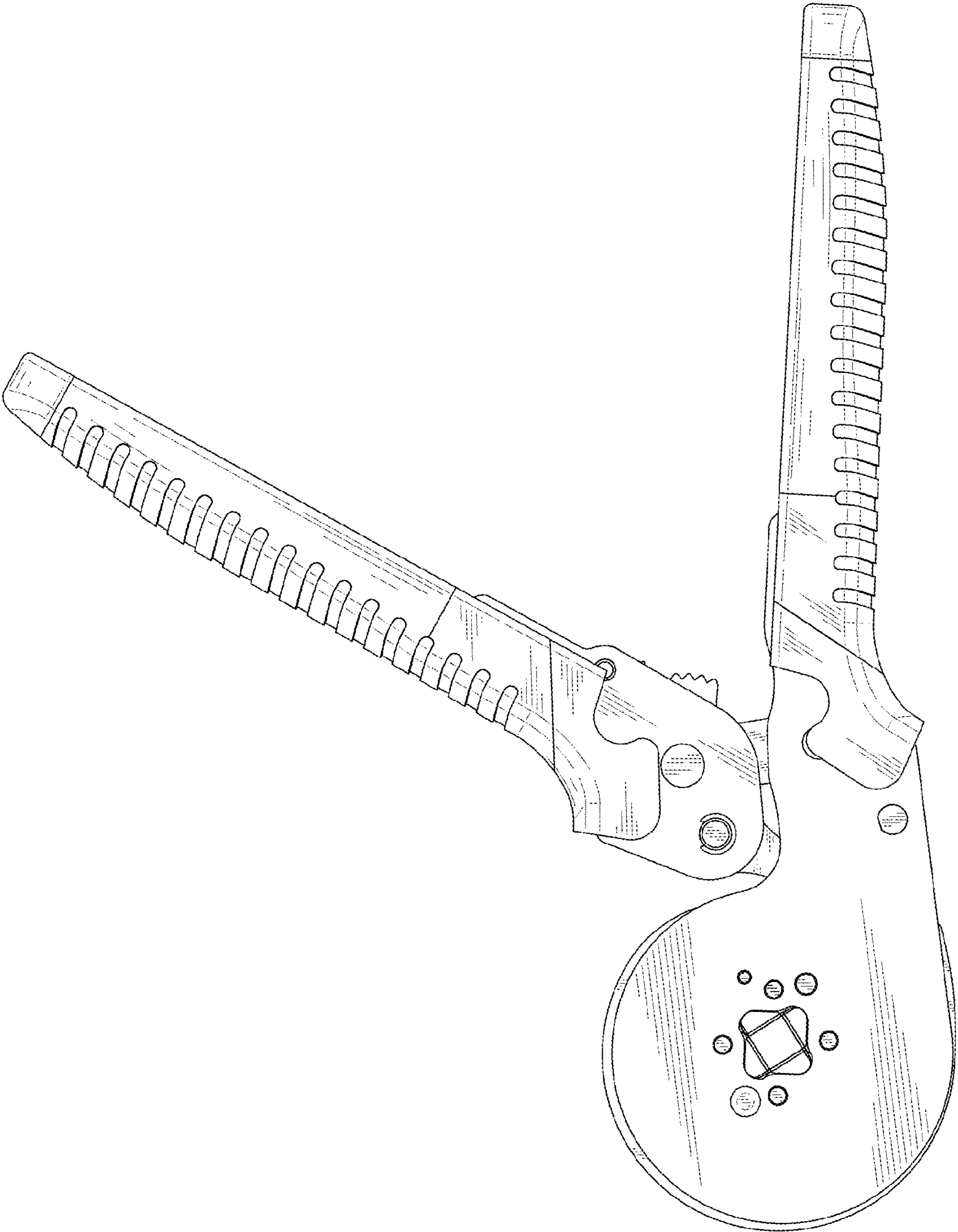

FIG. 4

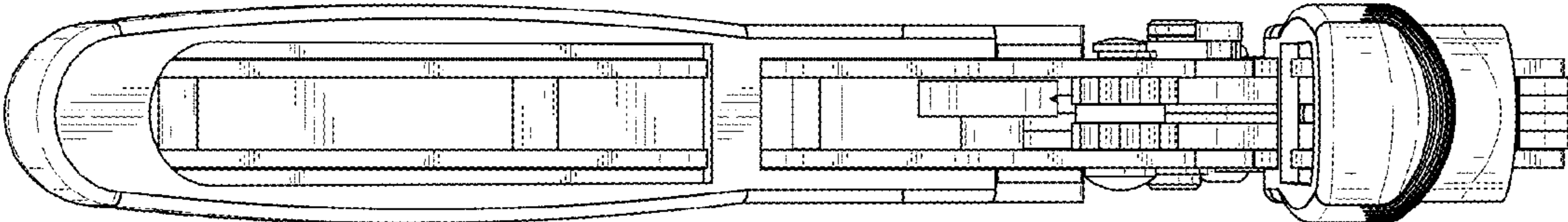

FIG. 5

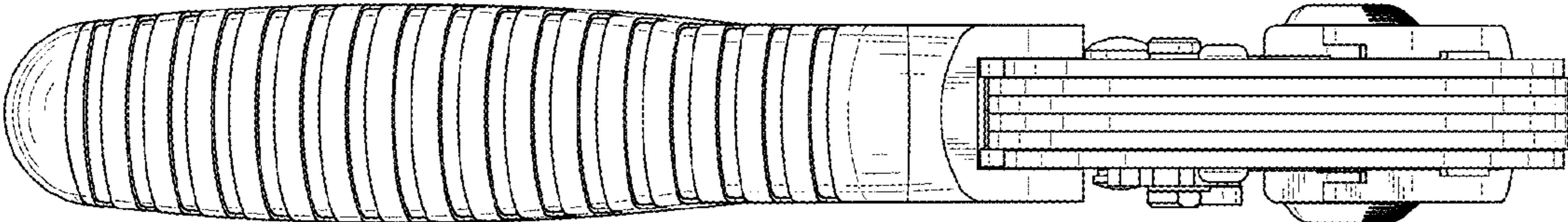

FIG. 6

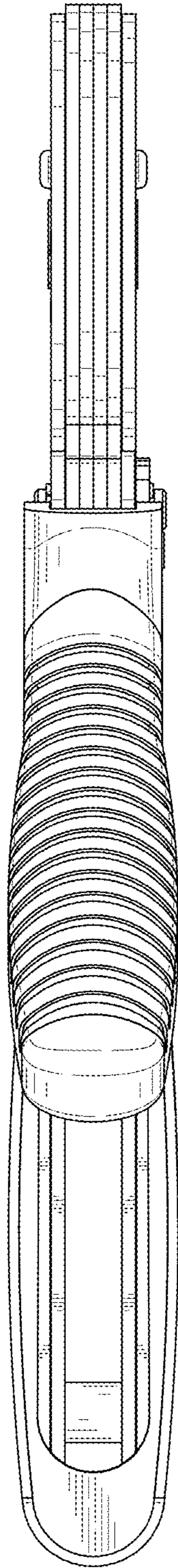

FIG. 7

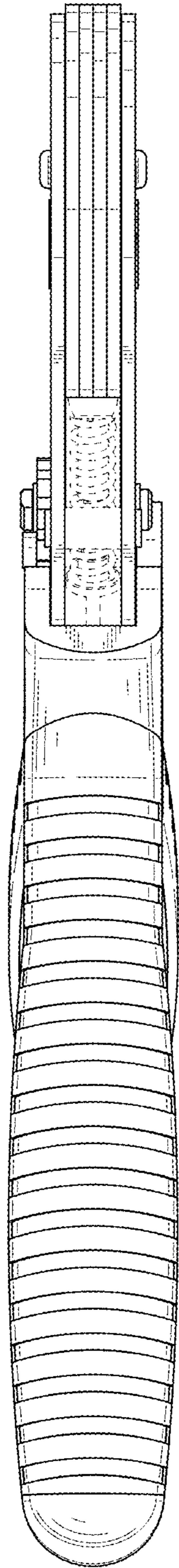

FIG. 8

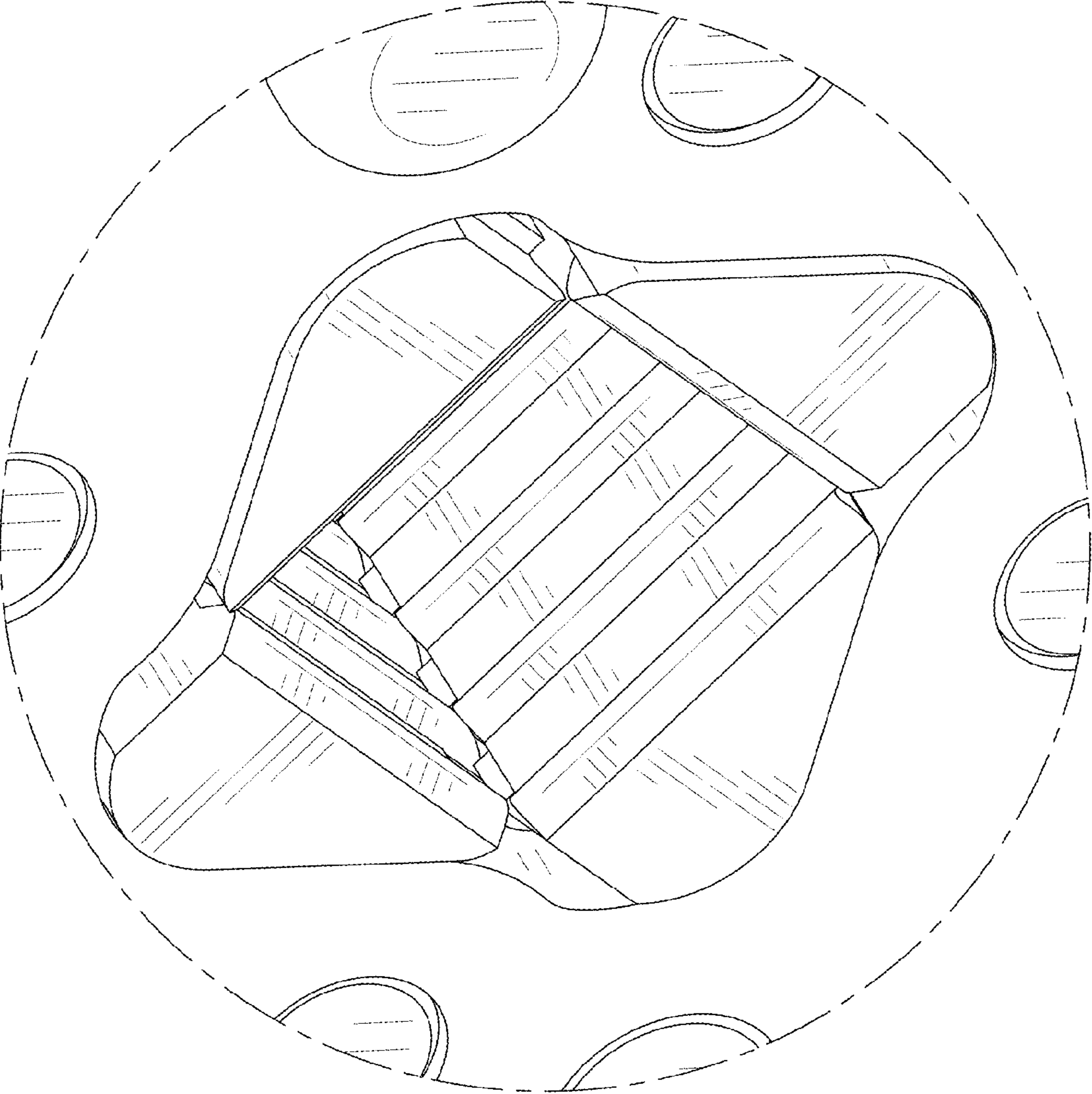

FIG. 9

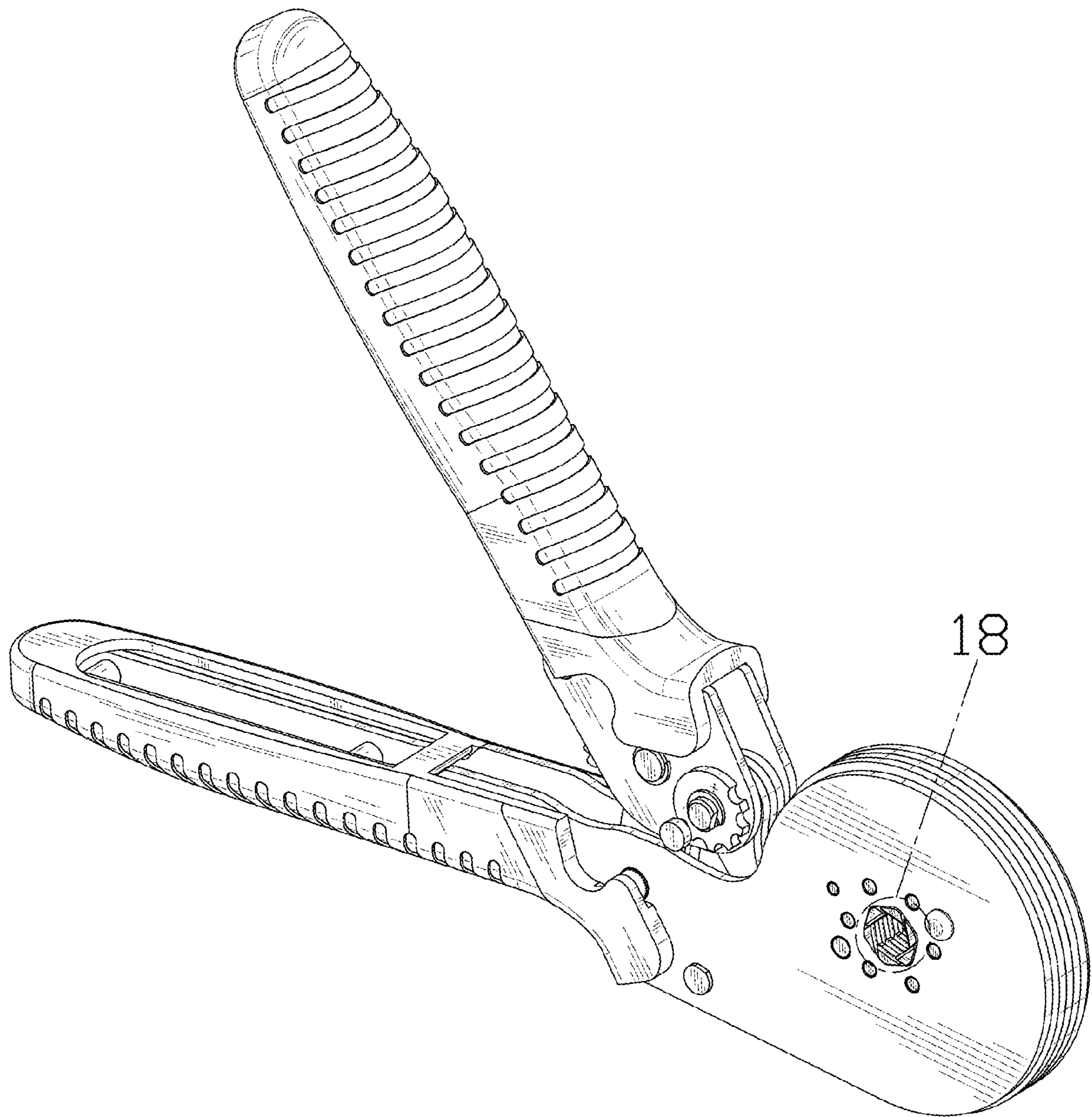

FIG. 10

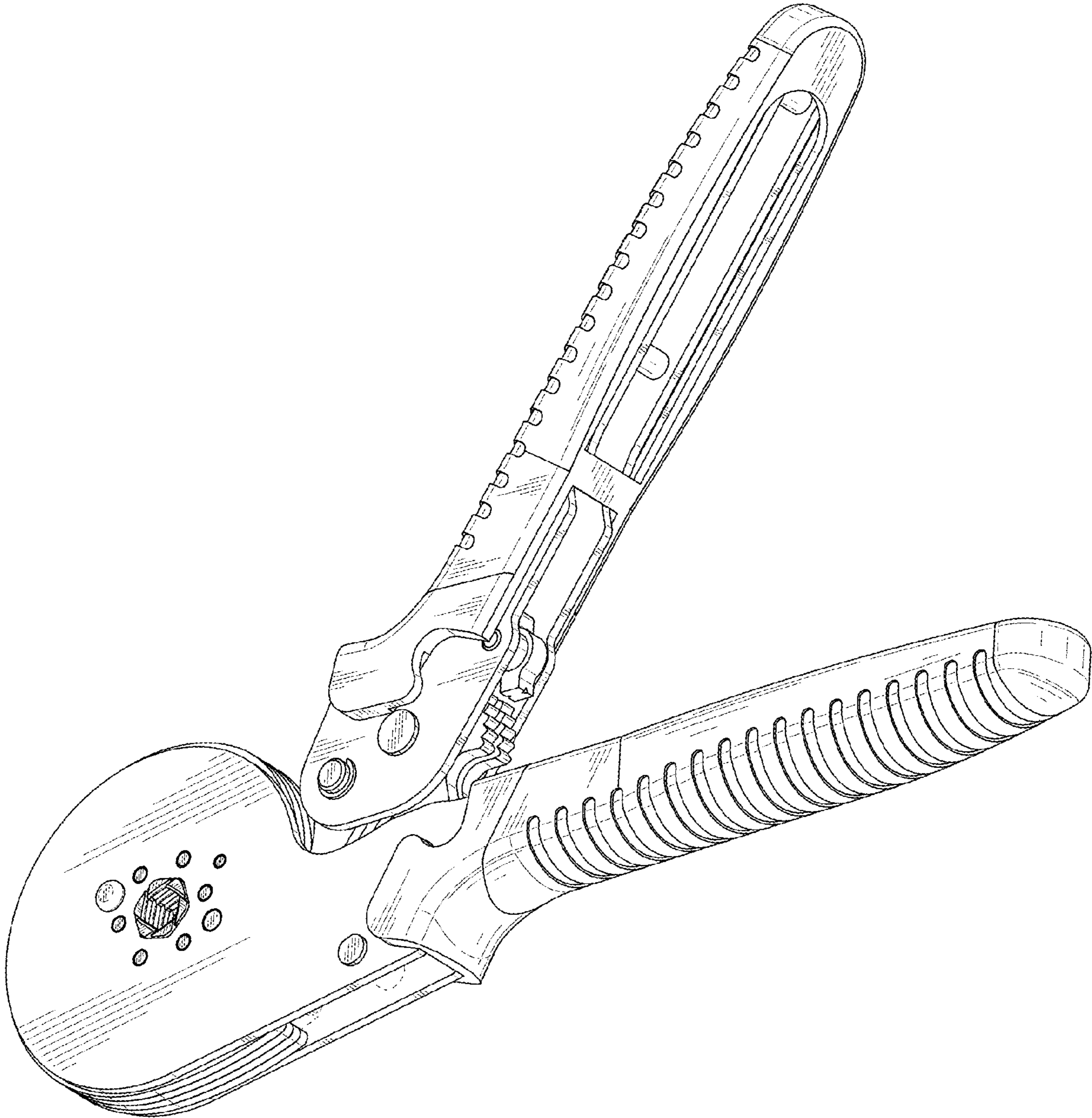

FIG. 11

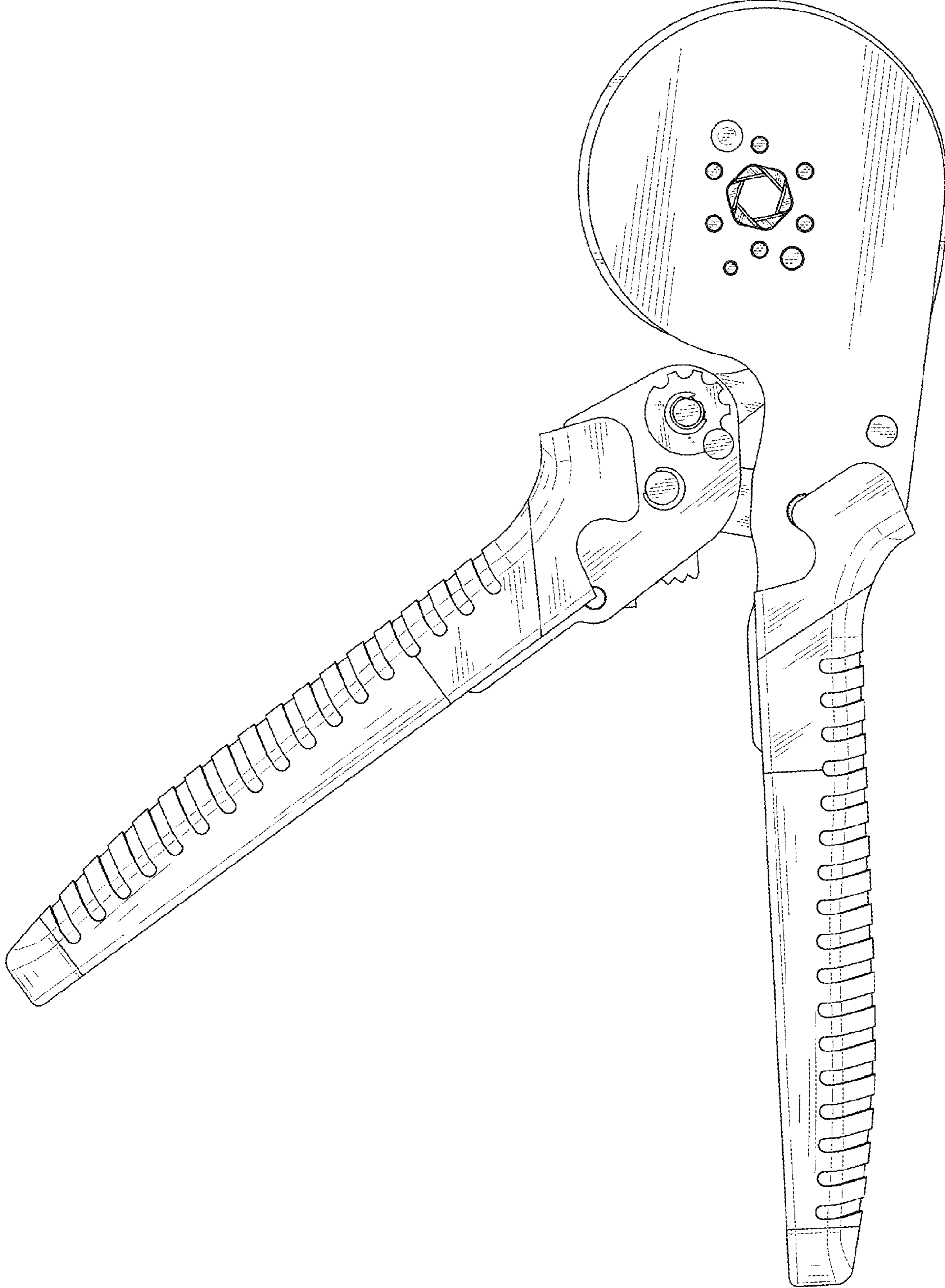

FIG. 12

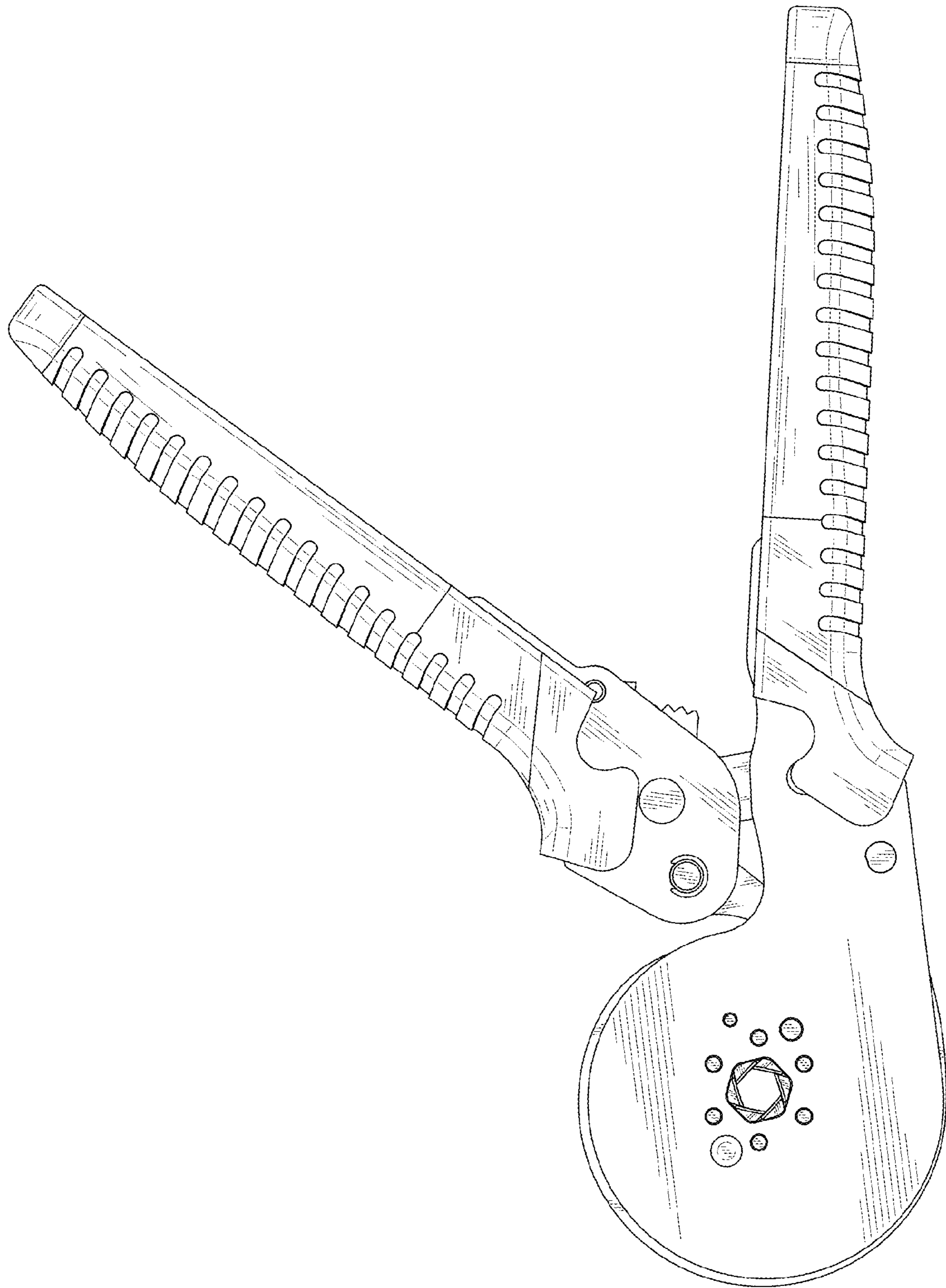

FIG. 13

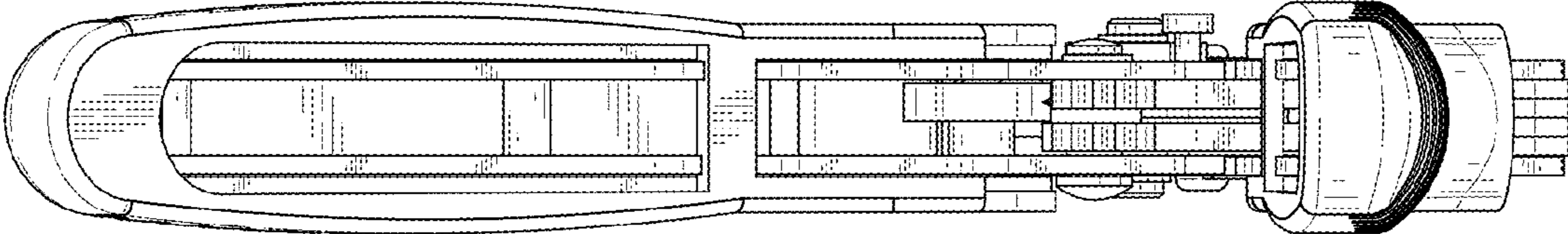

FIG. 14

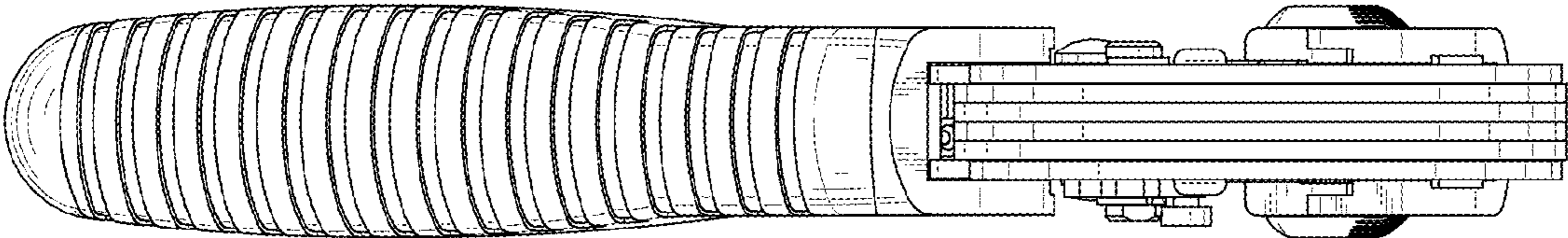

FIG. 15

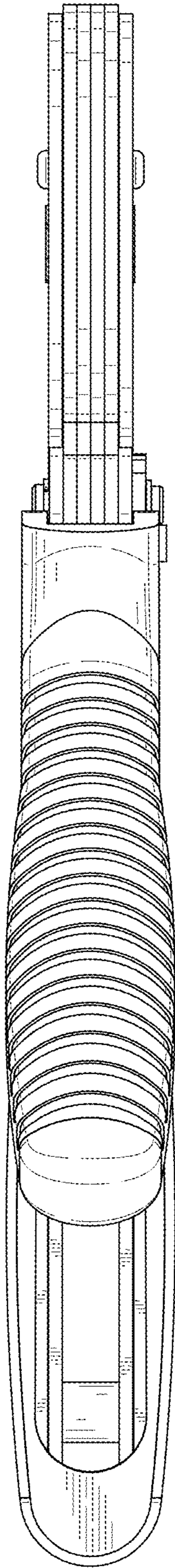

FIG. 16

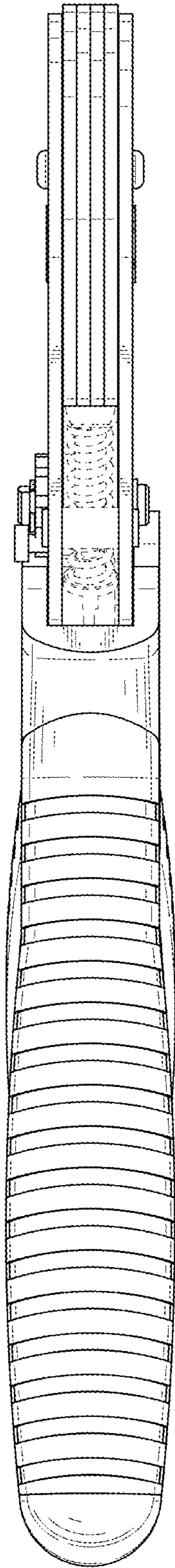

FIG. 17

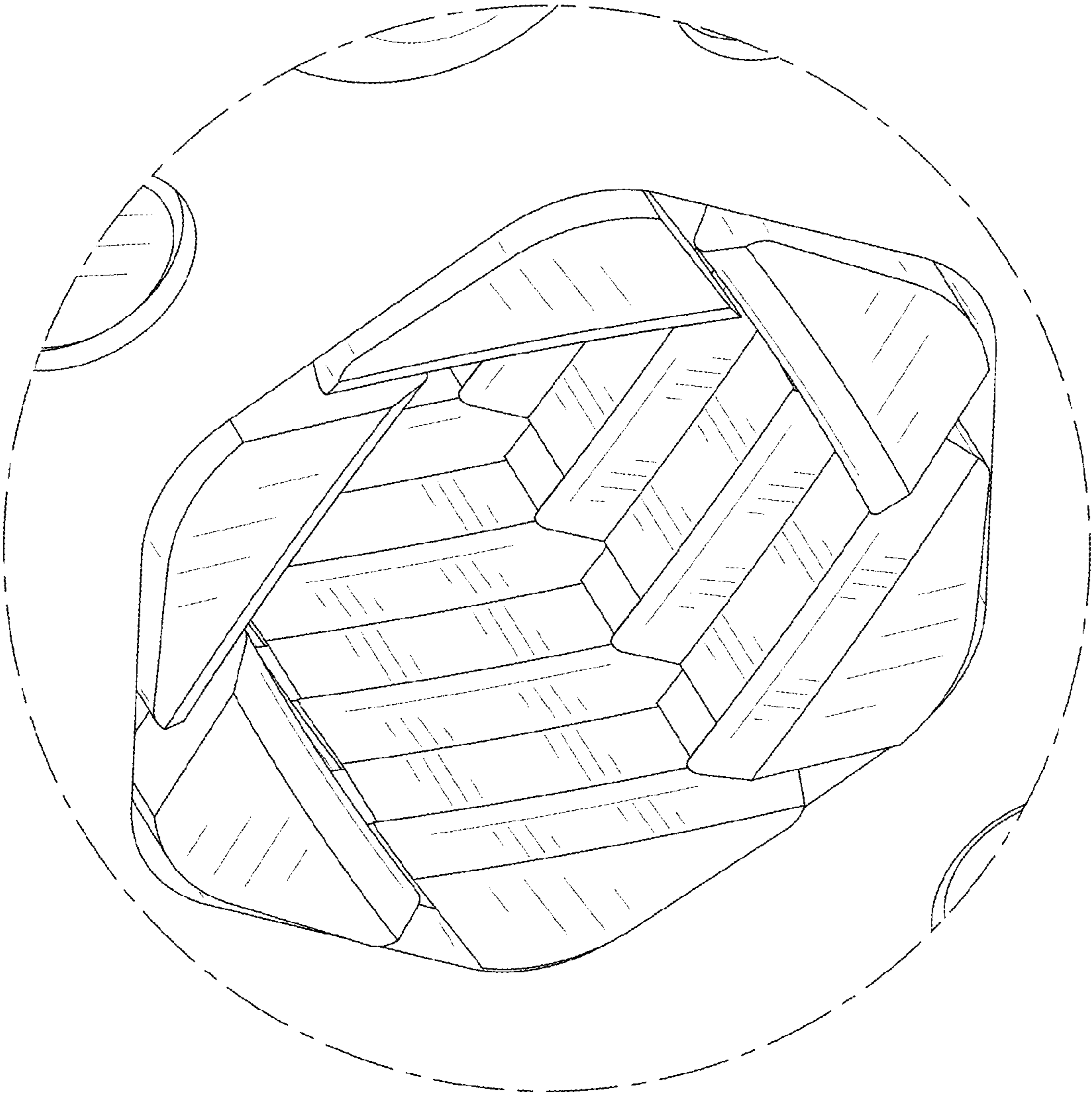

FIG. 18