



US00D963417S

(12) **United States Design Patent**
Friend et al.

(10) **Patent No.:** **US D963,417 S**

(45) **Date of Patent:** **** *Sep. 13, 2022**

(54) **DRINKING CUP**

(71) Applicants: **Gealia Friend**, New York, NY (US);
Arash Moghaddam, New York, NY (US)

(72) Inventors: **Gealia Friend**, New York, NY (US);
Arash Moghaddam, New York, NY (US)

(*) Notice: This patent is subject to a terminal disclaimer.

(**) Term: **15 Years**

(21) Appl. No.: **29/748,619**

(22) Filed: **Aug. 31, 2020**

(51) **LOC (13) Cl.** **07-01**

(52) **U.S. Cl.**

USPC **D7/532; D7/523**

(58) **Field of Classification Search**

USPC D7/507, 509, 510, 511, 529, 531, 532,
D7/523, 533, 534, 535, 536, 392.1, 396.1,
D7/396.2, 300.1, 608; D3/202; D9/500,
D9/531, 516, 517, 549

CPC A47G 19/22; A47G 19/2288; A47G
19/2205; A47G 19/2211; A47G 19/2216;
A47J 41/0077; A47J 41/0088; A47J
43/27; B65D 1/265

See application file for complete search history.

(56) **References Cited**

U.S. PATENT DOCUMENTS

- 1,519,034 A * 12/1924 Livingston A47G 19/2288
215/12.1
- 1,879,820 A * 9/1932 Perry A47G 19/2205
215/371
- D99,531 S * 5/1936 Sterling D7/513
- D222,375 S * 10/1971 Bencik D7/523
- 3,729,114 A * 4/1973 Mari A47G 7/06
220/504

- 3,730,385 A * 5/1973 Rost B65D 1/265
206/520
- 3,840,678 A * 10/1974 Price A23P 30/00
426/104
- D239,151 S * 3/1976 Lundin A23P 30/00
D7/523

(Continued)

FOREIGN PATENT DOCUMENTS

- CN 303066004 * 1/2015
- CN 305457086 * 11/2019
- WO WOD096526-001 * 6/2017

OTHER PUBLICATIONS

180 Cup—Disposable Cup With Built-in Shot Glass—Shark Tank Products [online] URL: <https://allsharktankproducts.com/shark-tank-products-food-and-drink/180-cup-disposable-cup-with-built-in-shot-glass/> (site visited: Aug. 2021) (Year: 2014).*

(Continued)

Primary Examiner — Jae Liang

Assistant Examiner — Tia Ruth-Renee Polidori

(74) *Attorney, Agent, or Firm* — David W Barman

(57)

CLAIM

We claim the ornamental design for a drinking cup, as shown and described.

DESCRIPTION

FIG. 1 is a bottom perspective view of the present invention. FIG. 2 is a top perspective view of the present invention. FIG. 3 is a cross-sectional view taken along section lines 3-3 in FIG. 6.

FIG. 4 is a top view of the present invention. FIG. 5 is a bottom view of the present invention; and, FIG. 6 is a side view of the present invention.

The broken line arrows in FIG. 6 depict cross-sectional view indicia and form no part of the claimed design.

1 Claim, 6 Drawing Sheets

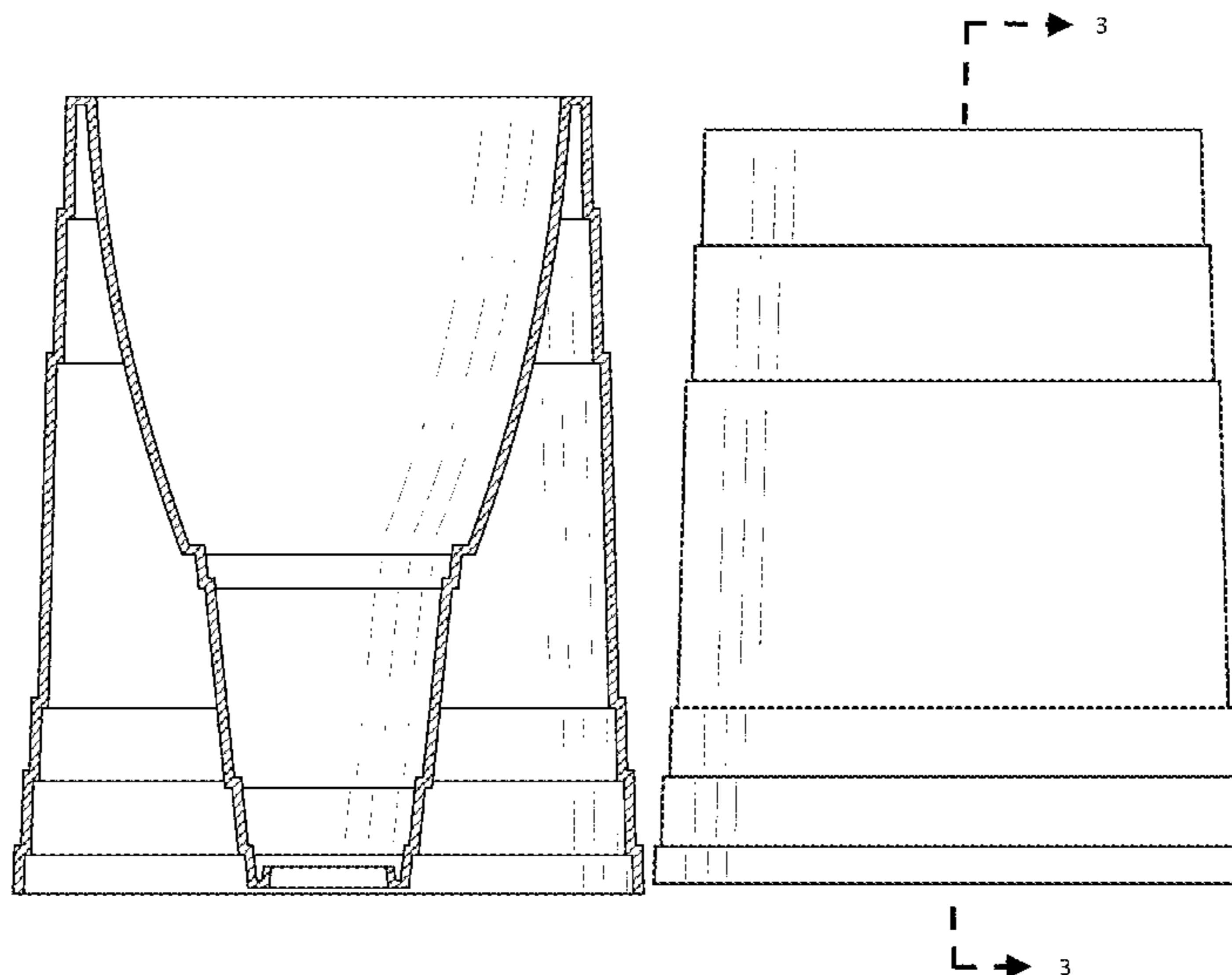

(56)

References Cited

U.S. PATENT DOCUMENTS

D269,638 S * 7/1983 Frye, Jr. A47G 19/2205
 D358,080 S * 5/1995 Handler D7/507
 D568,685 S * 5/2008 Bodum D7/500
 D607,692 S * 1/2010 Skala A47G 19/2288
 D616,705 S * 6/2010 DuBois D7/510
 D656,009 S * 3/2012 Ortiz D9/500
 D886,988 S * 6/2020 Lu B65D 1/265
 D888,877 S * 6/2020 White D24/121
 D900,550 S * 11/2020 Rupp A47G 7/06
 D915,202 S * 4/2021 Calderaio B65D 1/265
 D932,899 S * 10/2021 Calderaio D9/503
 2014/0209610 A1 * 7/2014 Plott A47G 19/2205
 2022/0081163 A1 * 3/2022 Adams B65D 21/086

OTHER PUBLICATIONS

Fineline Quenchers 4112-CL Blaster Bomb Shot Cups _ Power Bombs—25_Pack [online] URL: <https://www.webstaurantstore.com/>

fineline-quenchers-4112-cl-blaster-bomb-shot-cups-power-bombs-pack/ (site visited: Aug. 2021) (Year: 2017).*

How to serve the Jägerbomb with the Jäger shot glass upside down—Quora [online] URL: <https://www.quora.com/How-do-you-serve-the-J%C3%A4gerbomb-with-the-J%C3%A4gershot-glass-upside-down> (site visited: Aug. 2021) (Year: 2017).*

Reverso Conical Measuring Cup _ Groupon Goods [online] URL: https://www.groupon.com/deals/gg-ca-reversoconical-measuring-cup?checkoutError=deal_unavailable&optionId=d9f15425-09cf-4573-af10-38005fa2df0e (site visited: Aug. 2021) (Year: 2019).*

Boilermaker Cocktail Recipe [online] URL: <https://www.diffordsguide.com/cocktails/recipe/282/boilermaker> (site visited: Aug. 2021) (Year: 2021).*

Urban Trend UTU1KG0028 Reverso Plus Mea . . . [online] URL: <https://www.overstock.com/Home-Garden/Urban-Trend-UTU1KG0028-Reverso-Plus-Measuring-Cup-with-Funnel-Plastic/19847897/product.html> (site visited: Aug. 2021) (Year: 2021).*

Grand Marnier Shot Glass Plastic Invert., [online] URL: https://www.ebay.com/itm/Grand-Marnier-Shot-Glass-Plastic-Inverted-Bottle-New-with-Defect-Clear-and-Red-/143614999980?_ul=IL (site visited: Aug. 2021) (Year: 2021).*

* cited by examiner

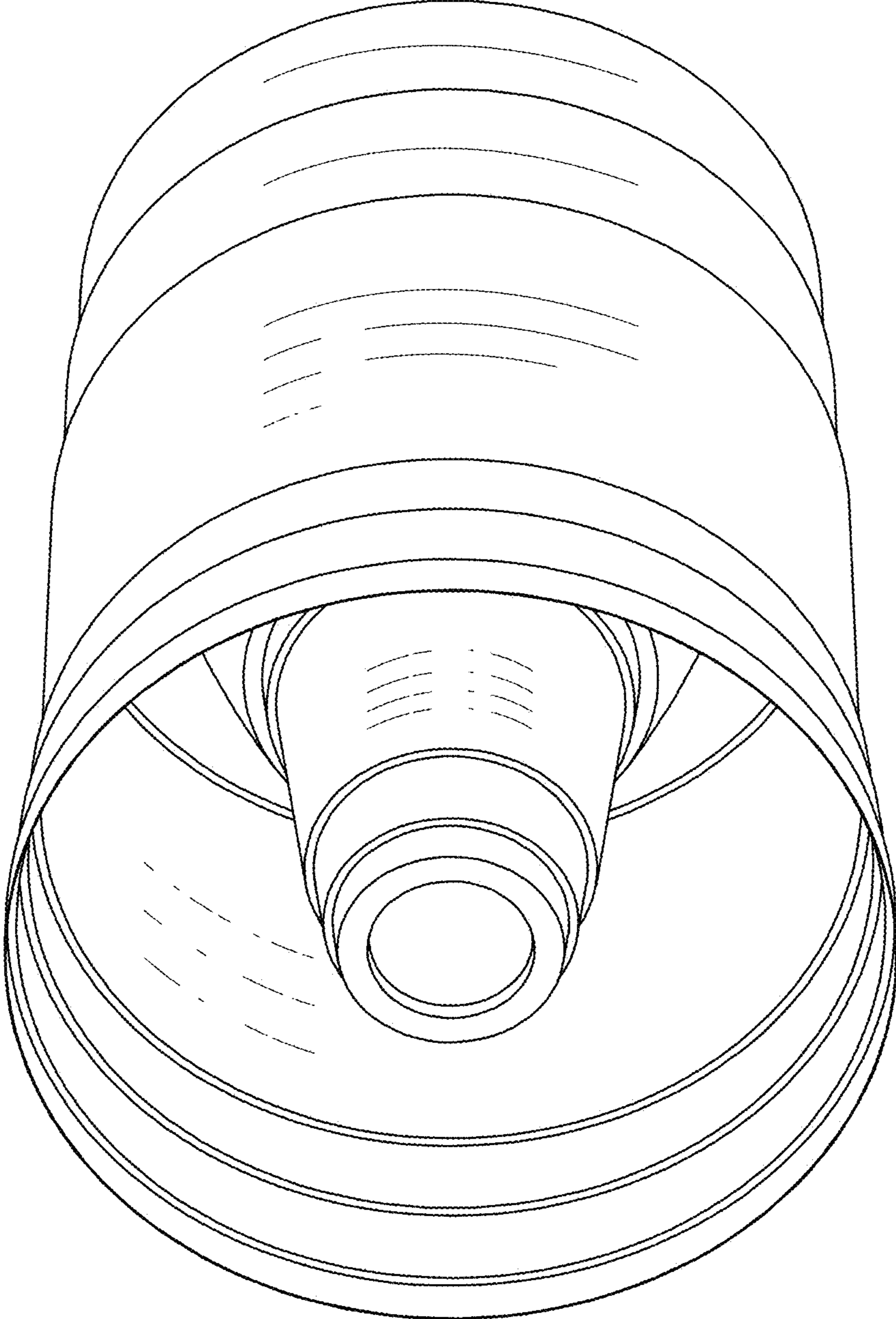

Fig. 1

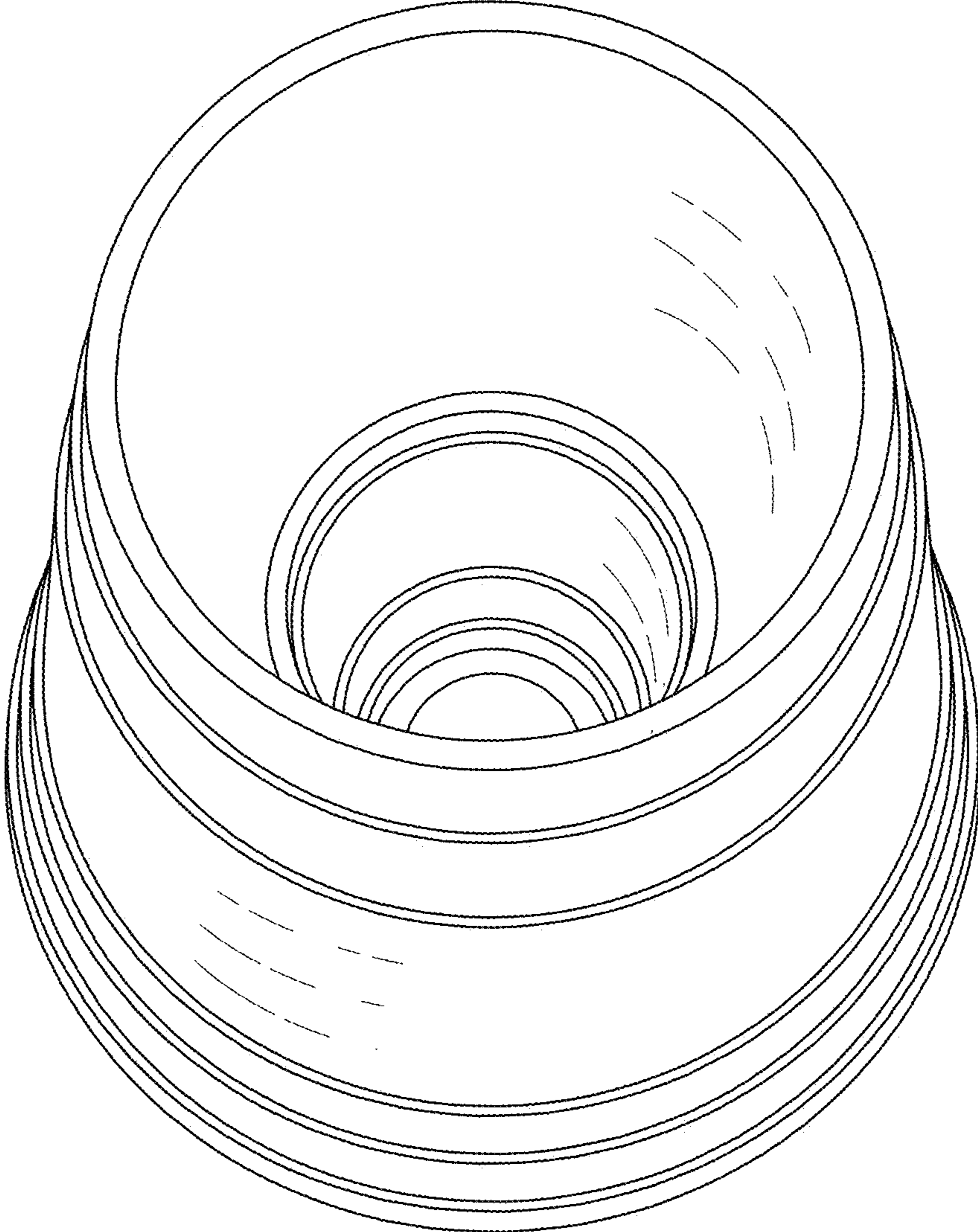

Fig. 2

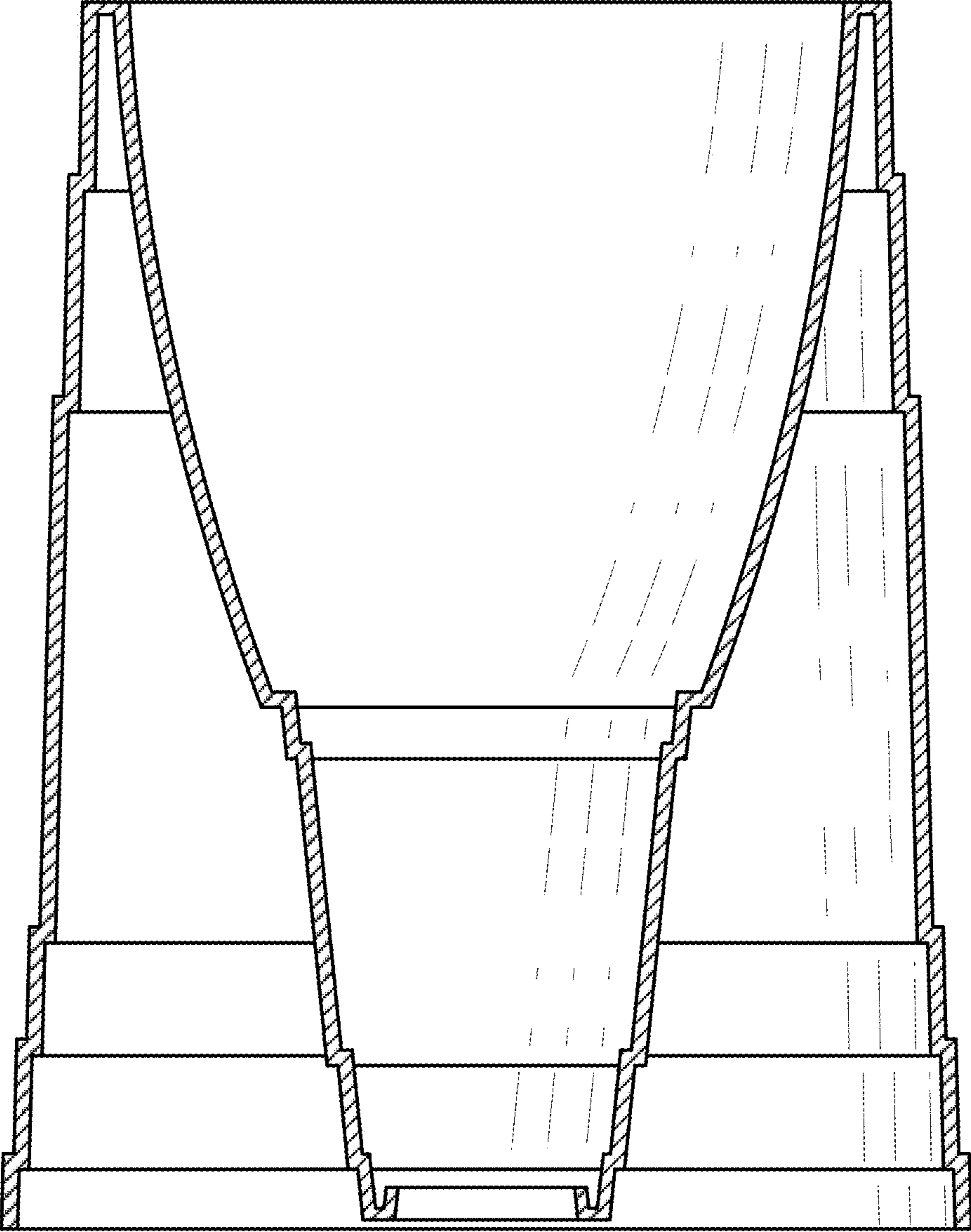

FIG. 3

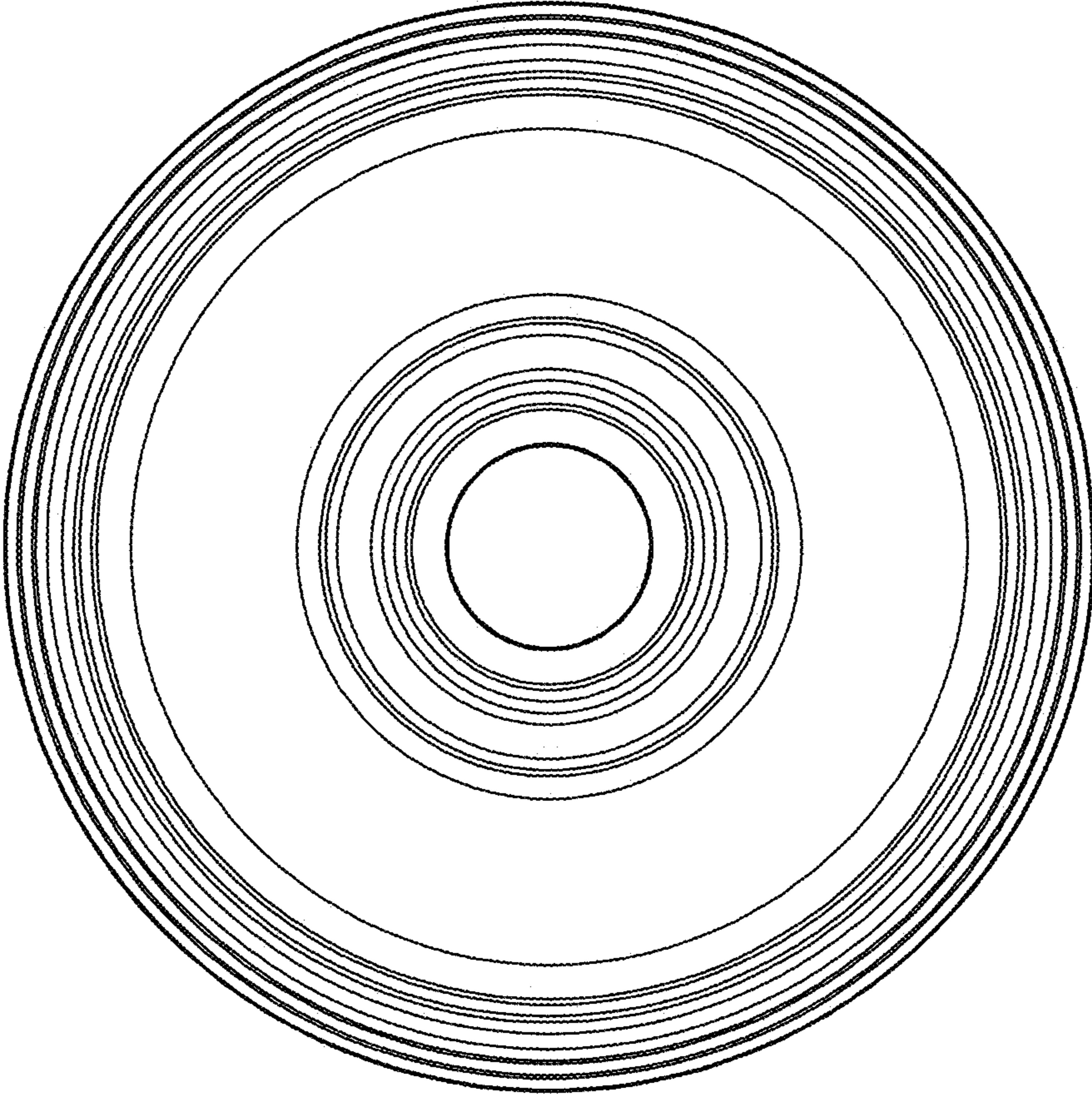

Fig. 4

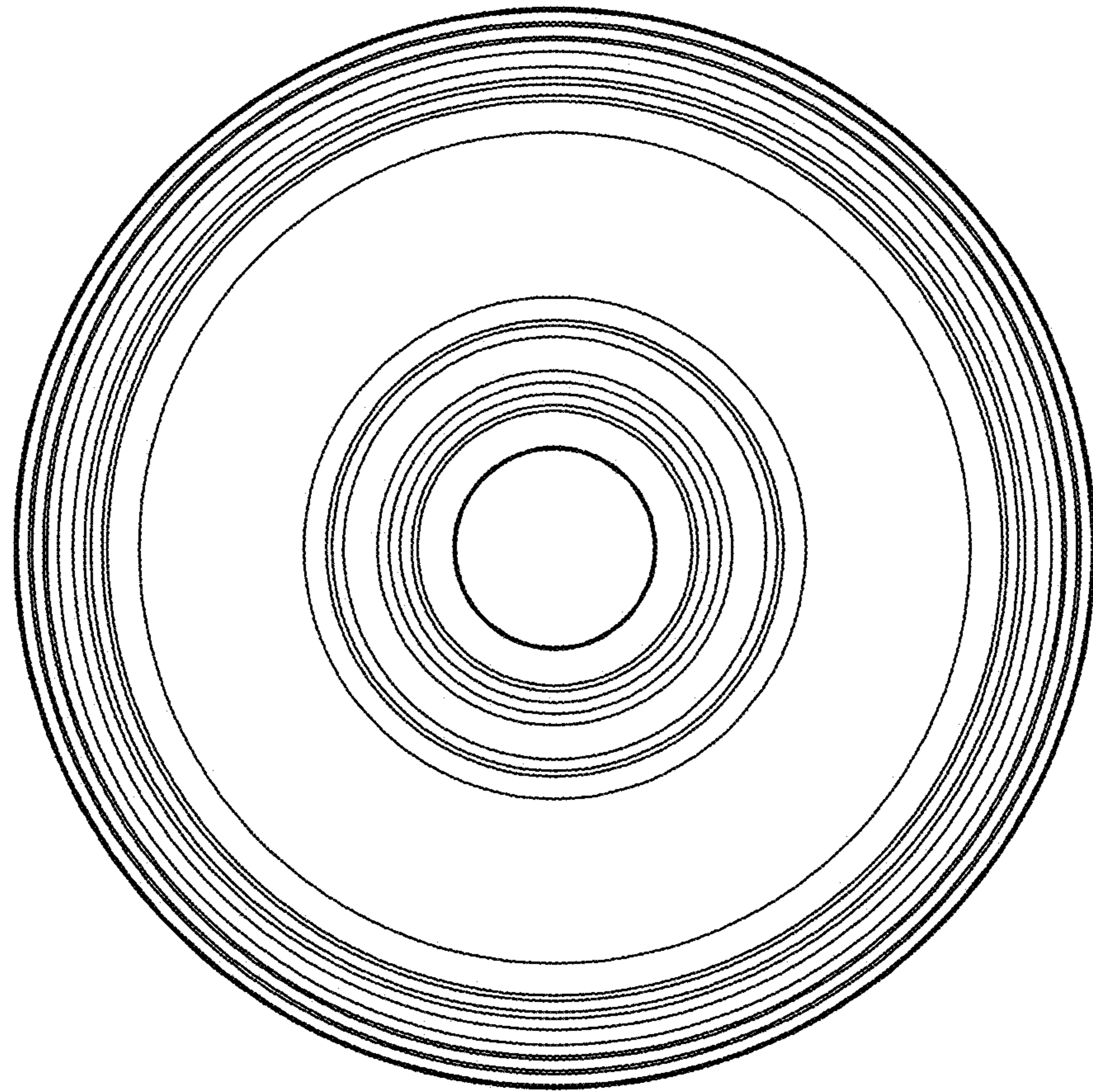

Fig. 5

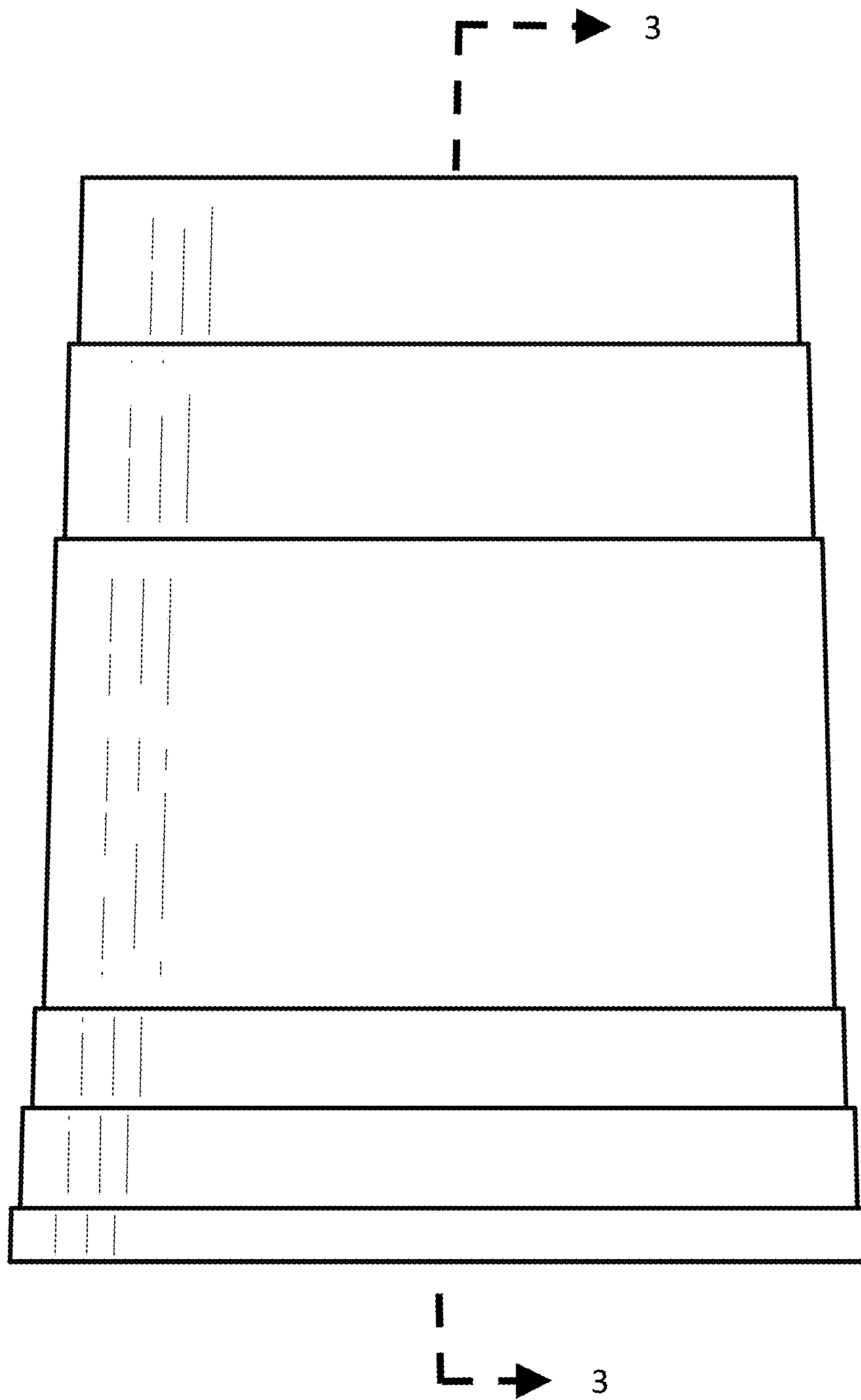

Fig. 6