



US00D963408S

(12) **United States Design Patent**
Zheng

(10) **Patent No.:** **US D963,408 S**
(45) **Date of Patent:** **** Sep. 13, 2022**

(54) **CUTLERY HANDLES**

DESCRIPTION

(71) Applicant: **REYNOLDS CONSUMER PRODUCTS LLC**, Lake Forest, IL (US)
(72) Inventor: **Look Zheng**, Shenzhen (CN)
(73) Assignee: **REYNOLDS CONSUMER PRODUCTS LLC**, Lake Forest, IL (US)
(**) Term: **15 Years**
(21) Appl. No.: **29/767,085**
(22) Filed: **Jan. 20, 2021**
(51) **LOC (13) Cl.** **07-03**
(52) **U.S. Cl.**
USPC **D7/401.2; D7/642; D7/653**
(58) **Field of Classification Search**
USPC D7/368, 401.2, 642-645, 653-664, 669, D7/675-677, 683, 687-689, 691; D8/107, 300-301; D22/117-118
(Continued)

(56) **References Cited**

U.S. PATENT DOCUMENTS

1,435,890 A * 11/1922 Bothe A47G 21/04 30/328
D224,344 S * 7/1972 Basterra D7/653
(Continued)

Primary Examiner — Ricky Pham

(74) *Attorney, Agent, or Firm* — Baker Botts L.L.P.

(57) **CLAIM**

The ornamental designs for cutlery handles, as shown and described.

FIG. 1 is a top perspective view of a cutlery handle for a fork in accordance with an aspect of the disclosed subject matter. FIG. 2 is a bottom perspective view of the cutlery handle of FIG. 1. FIG. 3 is a rear view of the cutlery handle of FIG. 1. FIG. 4 is a left side view of the cutlery handle of FIG. 1, wherein the right side view is a mirror of the left side view. FIG. 5 is a top view of the cutlery handle of FIG. 1. FIG. 6 is a bottom view of the cutlery handle of FIG. 1. FIG. 7 is a top perspective view of a cutlery handle for a spoon in accordance with another aspect of the disclosed subject matter. FIG. 8 is a bottom perspective view of the cutlery handle of FIG. 7. FIG. 9 is a rear view of the cutlery handle of FIG. 7. FIG. 10 is a left side view of the cutlery handle of FIG. 7, wherein the right side view is a mirror of the left side view. FIG. 11 is a top view of the cutlery handle of FIG. 7. FIG. 12 is a bottom view of the cutlery handle of FIG. 7. FIG. 13 is a bottom perspective view of a cutlery handle for a knife in accordance with another aspect of the disclosed subject matter. FIG. 14 is a top perspective view of the cutlery handle of FIG. 13. FIG. 15 is a rear view of the cutlery handle of FIG. 14. FIG. 16 is a left side view of the cutlery handle of FIG. 14 as seen from the side of the edge of the knife. FIG. 17 is a right side view of the cutlery handle of FIG. 14 as seen from the side of the spine of the knife. FIG. 18 is a bottom view of the cutlery handle of FIG. 14; and, FIG. 19 is a top view of the cutlery handle of FIG. 14. The broken lines shown throughout the drawings indicate unclaimed subject matter and form no part of the claimed design. The dash-dot-dash broken lines define the bounds of the claimed design and form no part thereof.

1 Claim, 6 Drawing Sheets

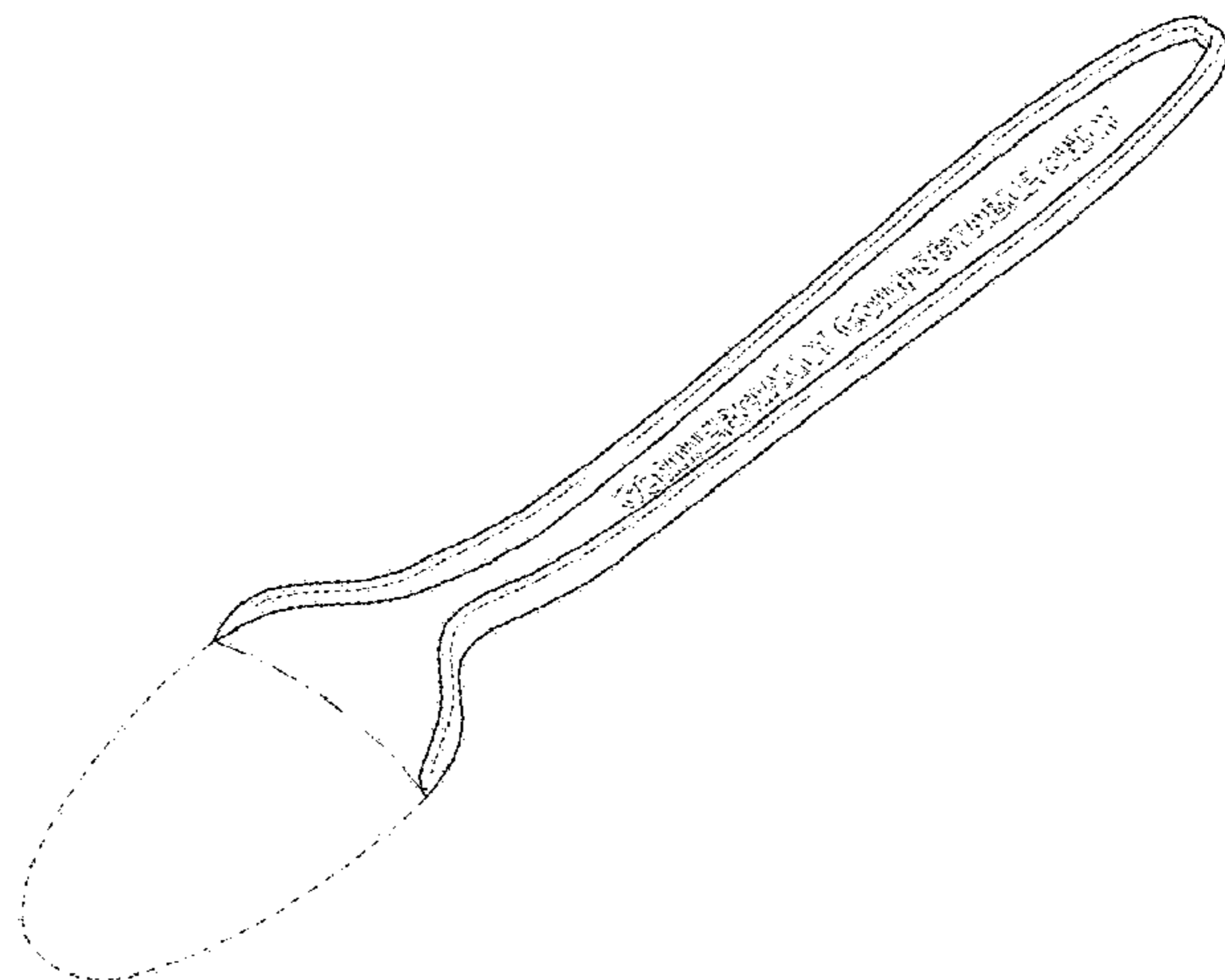
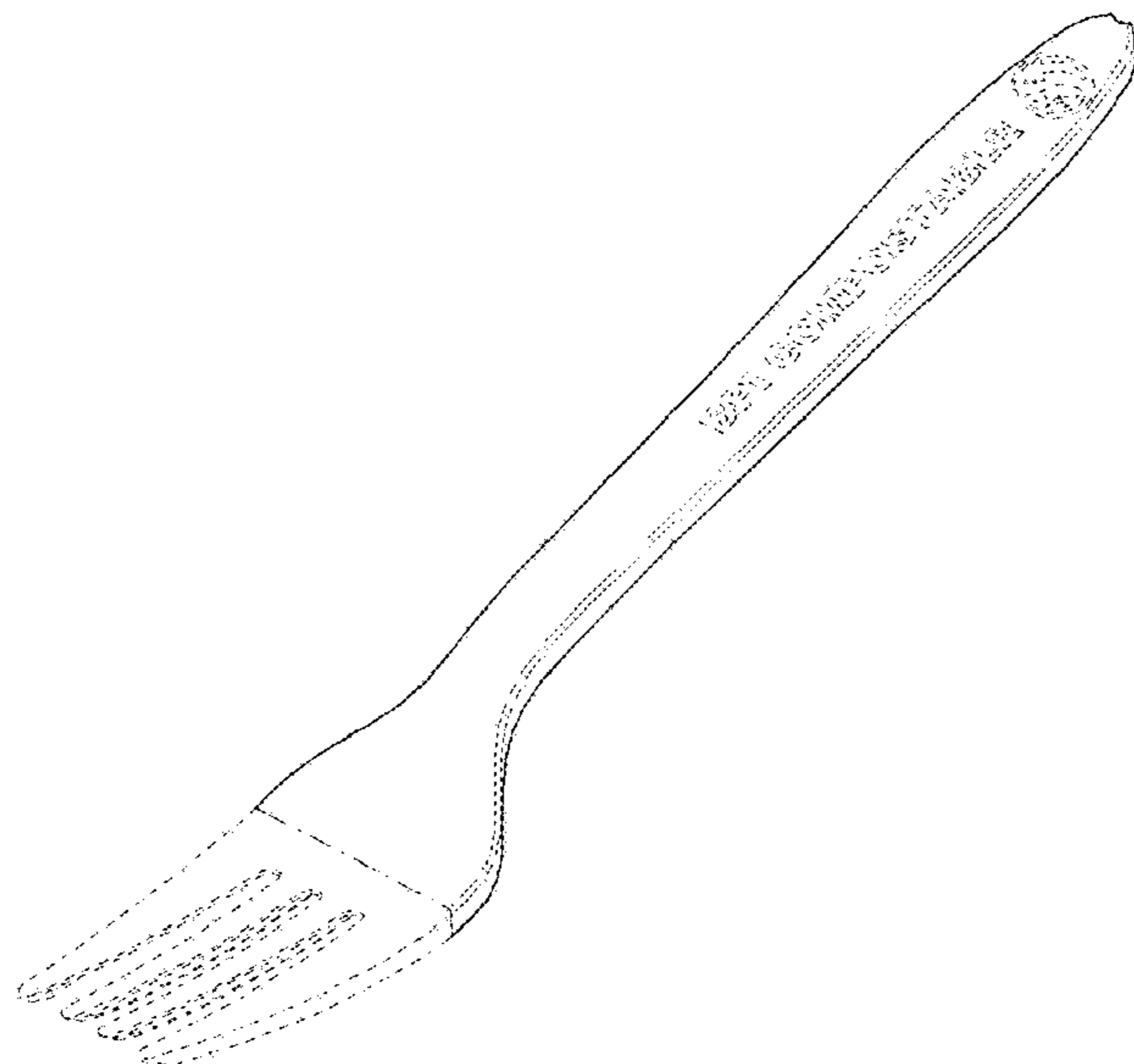

(58) **Field of Classification Search**

CPC ... A01D 9/02; A01D 9/04; A01D 9/06; A47G
21/00; A47G 21/004; A47G 21/005;
A47G 21/02; A47G 21/023; A47G 21/04;
A47G 21/06; A47G 21/08; A47G 21/181;
A47J 43/28; A47J 43/281; A47J 43/282;
A61F 13/10; A61J 7/0023; B25G 1/00;
B25G 1/01; B25G 1/02; B25G 3/00;
B65D 75/56; B65D 75/563; B65D
75/566; B67B 7/00; B67B 7/724; B67B
7/73

See application file for complete search history.

(56) **References Cited**

U.S. PATENT DOCUMENTS

D231,893	S	*	6/1974	Manderfield	D7/653
D387,956	S	*	12/1997	Gagnon	D7/653
D530,987	S	*	10/2006	Lee	D7/653
D531,860	S	*	11/2006	Lee	D7/653
D546,136	S	*	7/2007	Smith	D7/653
D580,716	S	*	11/2008	Huebscher	D7/653
D756,171	S	*	5/2016	Mou	D7/653
D775,498	S	*	1/2017	Gallop	D7/642
D778,120	S	*	2/2017	Mou	D7/645
10,959,555	B2	*	3/2021	Lee	A47G 21/00
2005/0155229	A1	*	7/2005	Lee	A47G 21/06 30/322

* cited by examiner

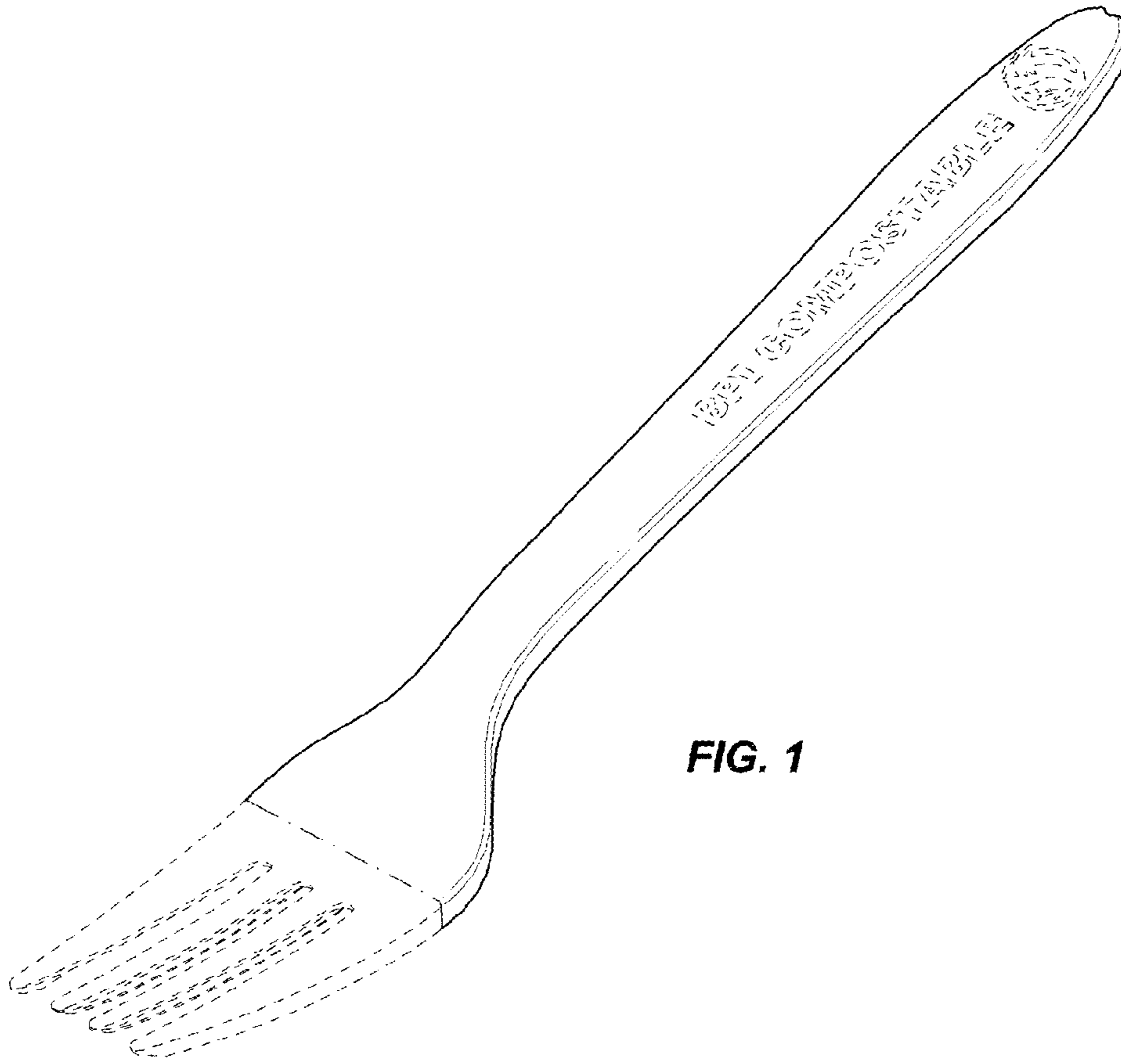

FIG. 1

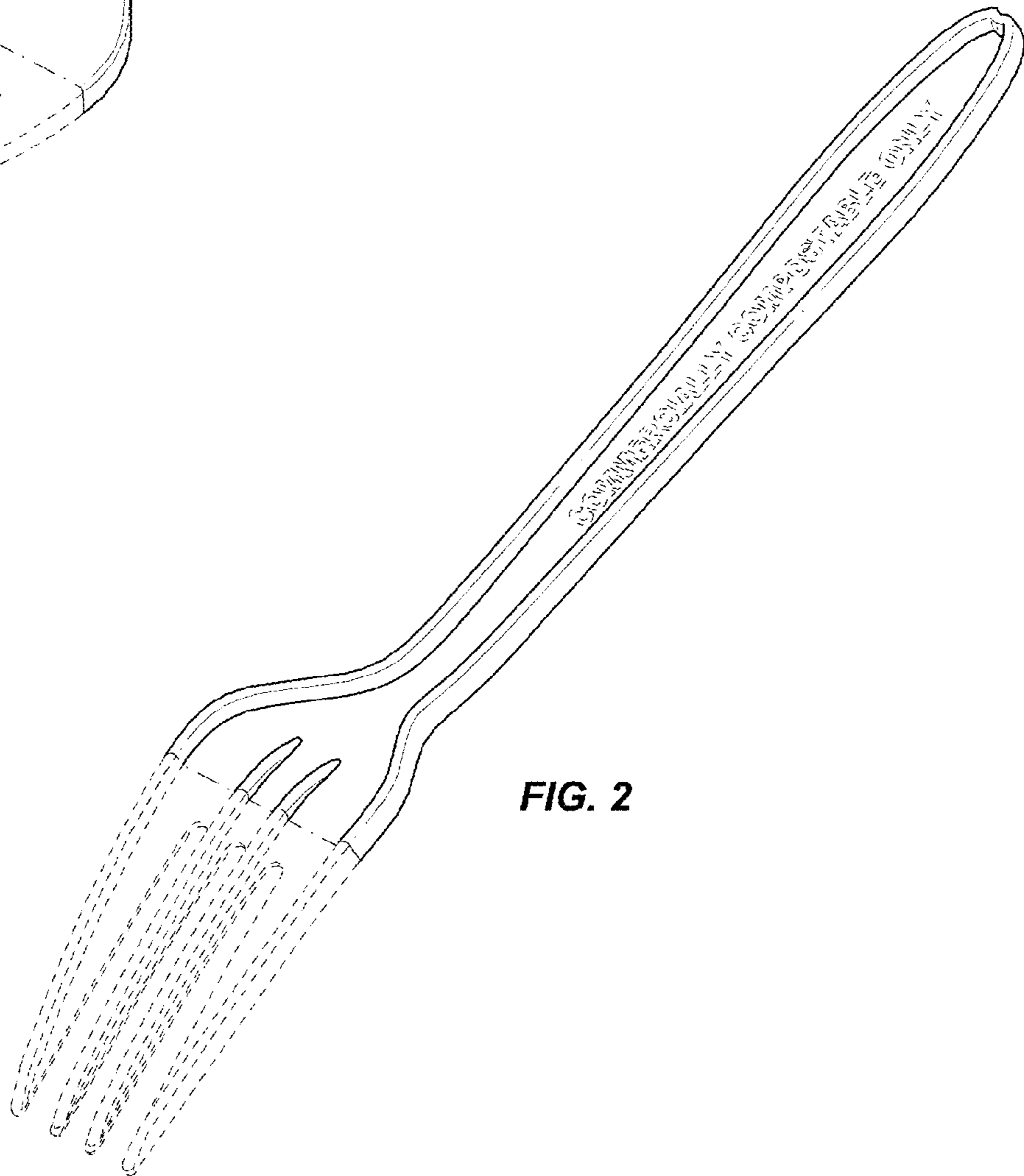

FIG. 2

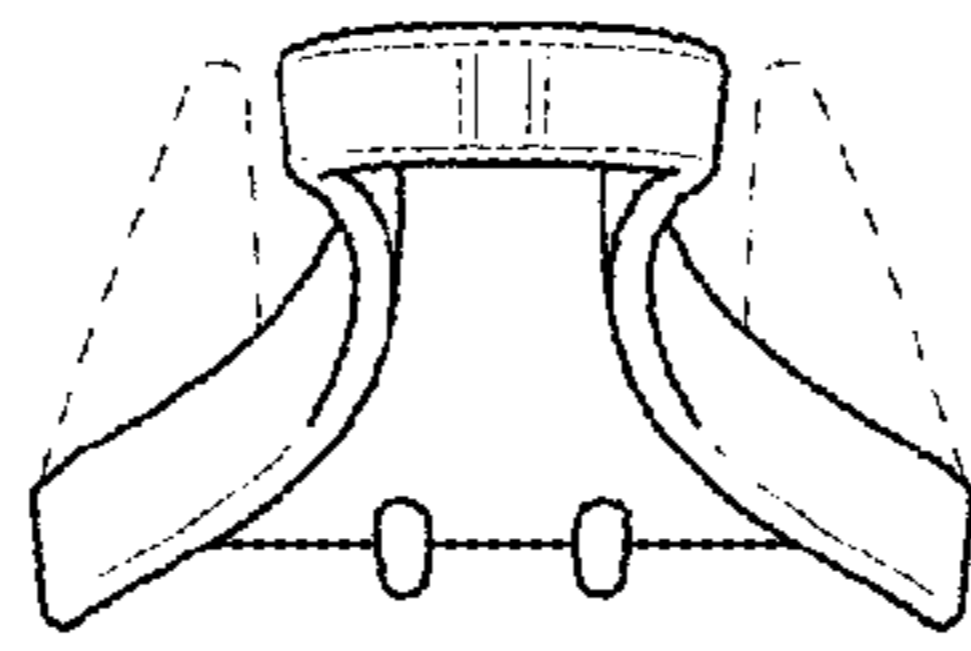

FIG. 3

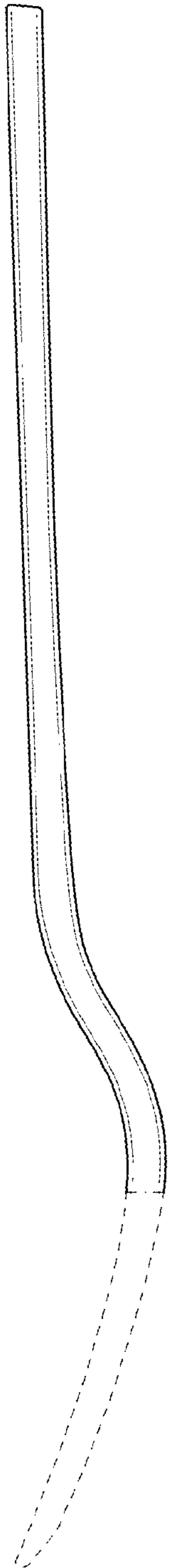

FIG. 4

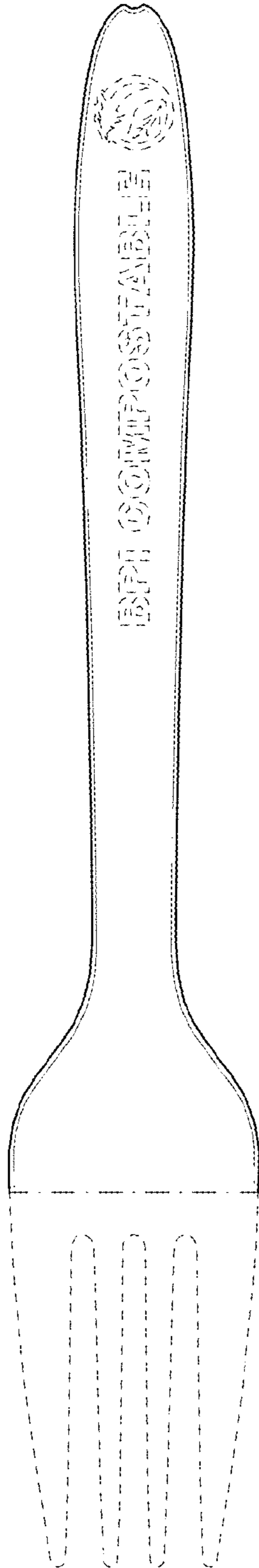

FIG. 5

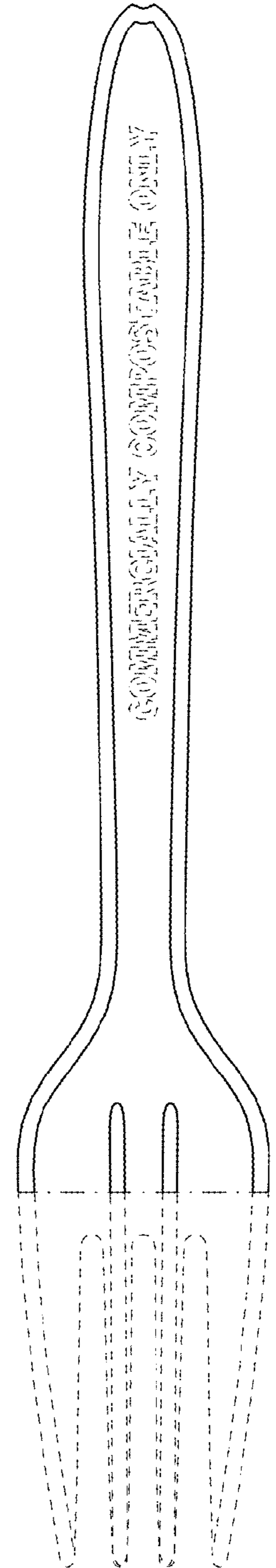
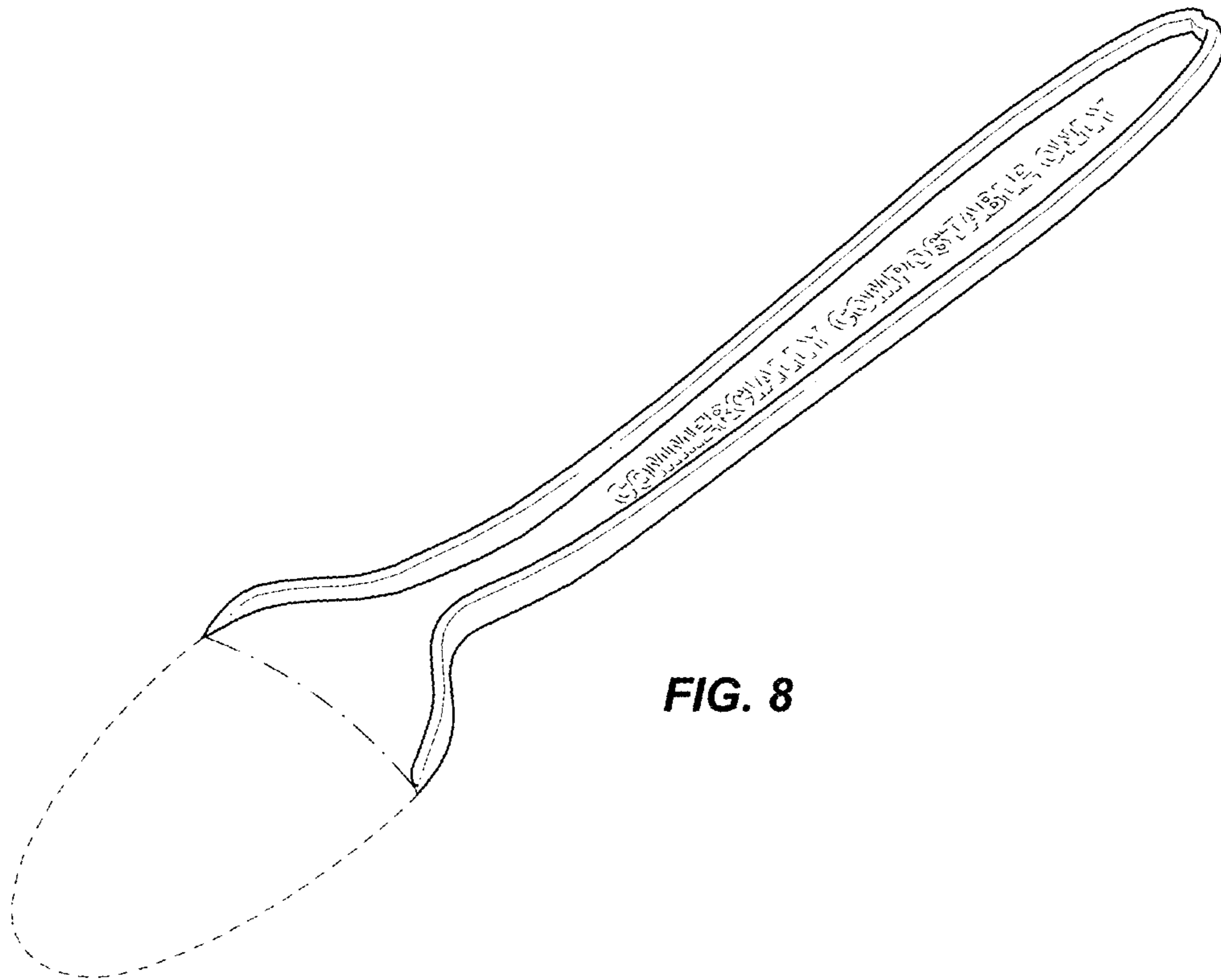
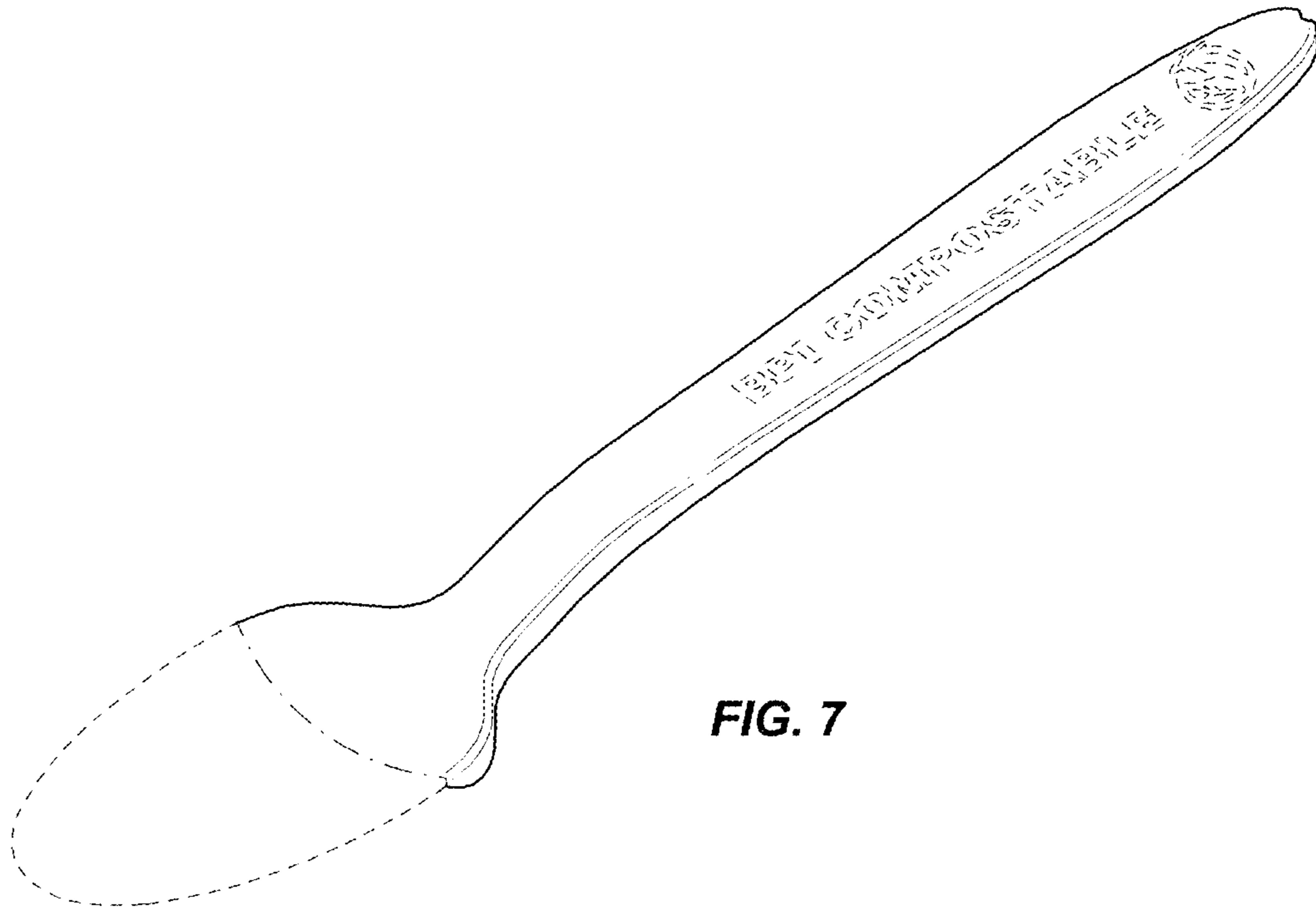

FIG. 6



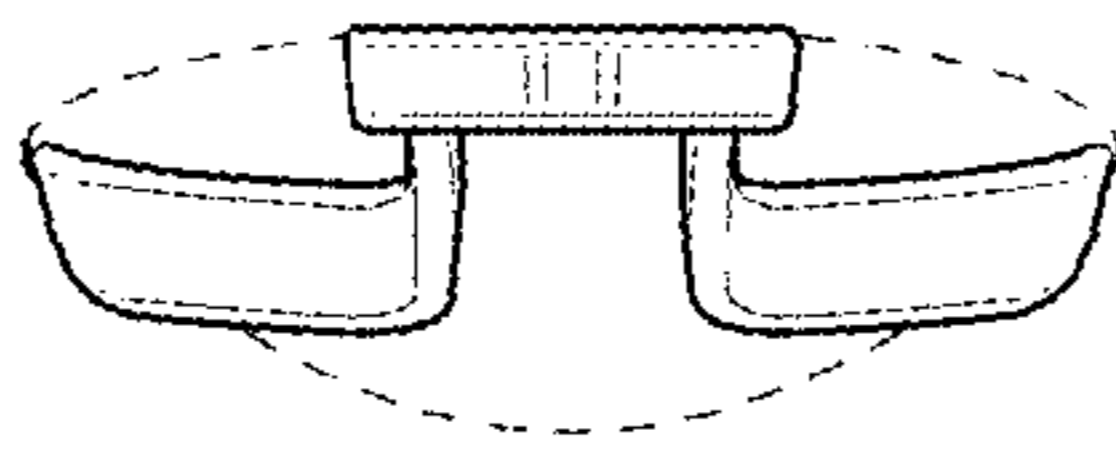

FIG. 9

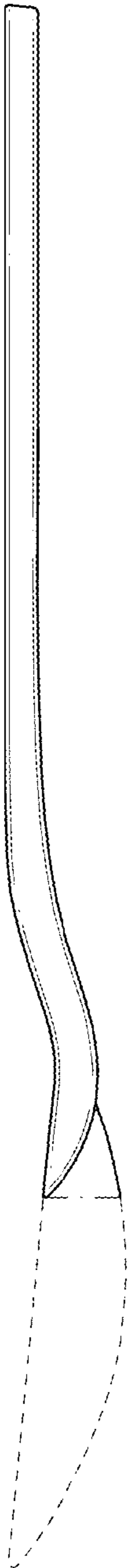

FIG. 10

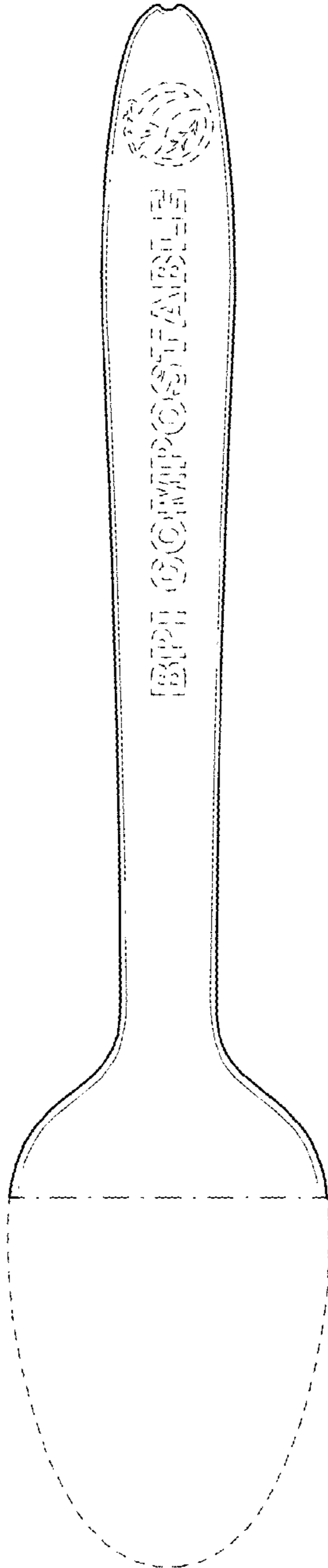

FIG. 11

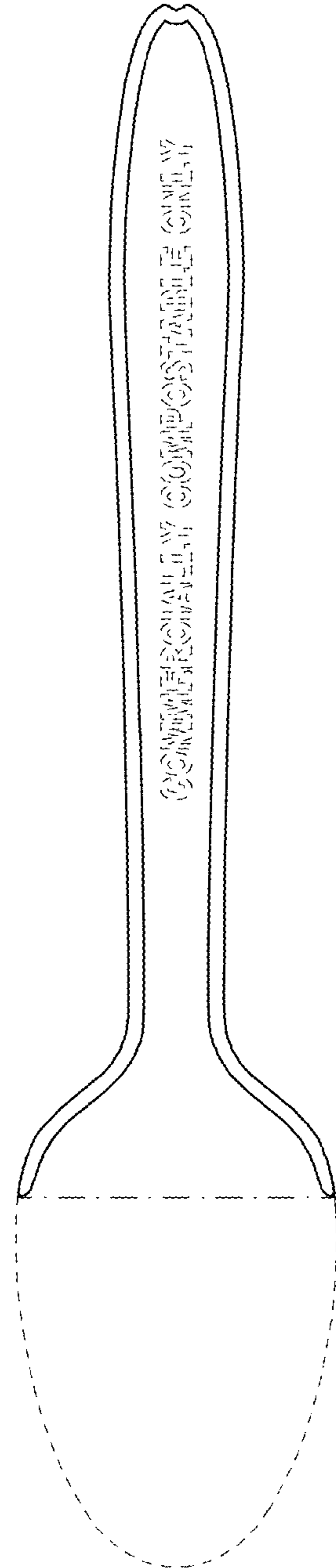

FIG. 12

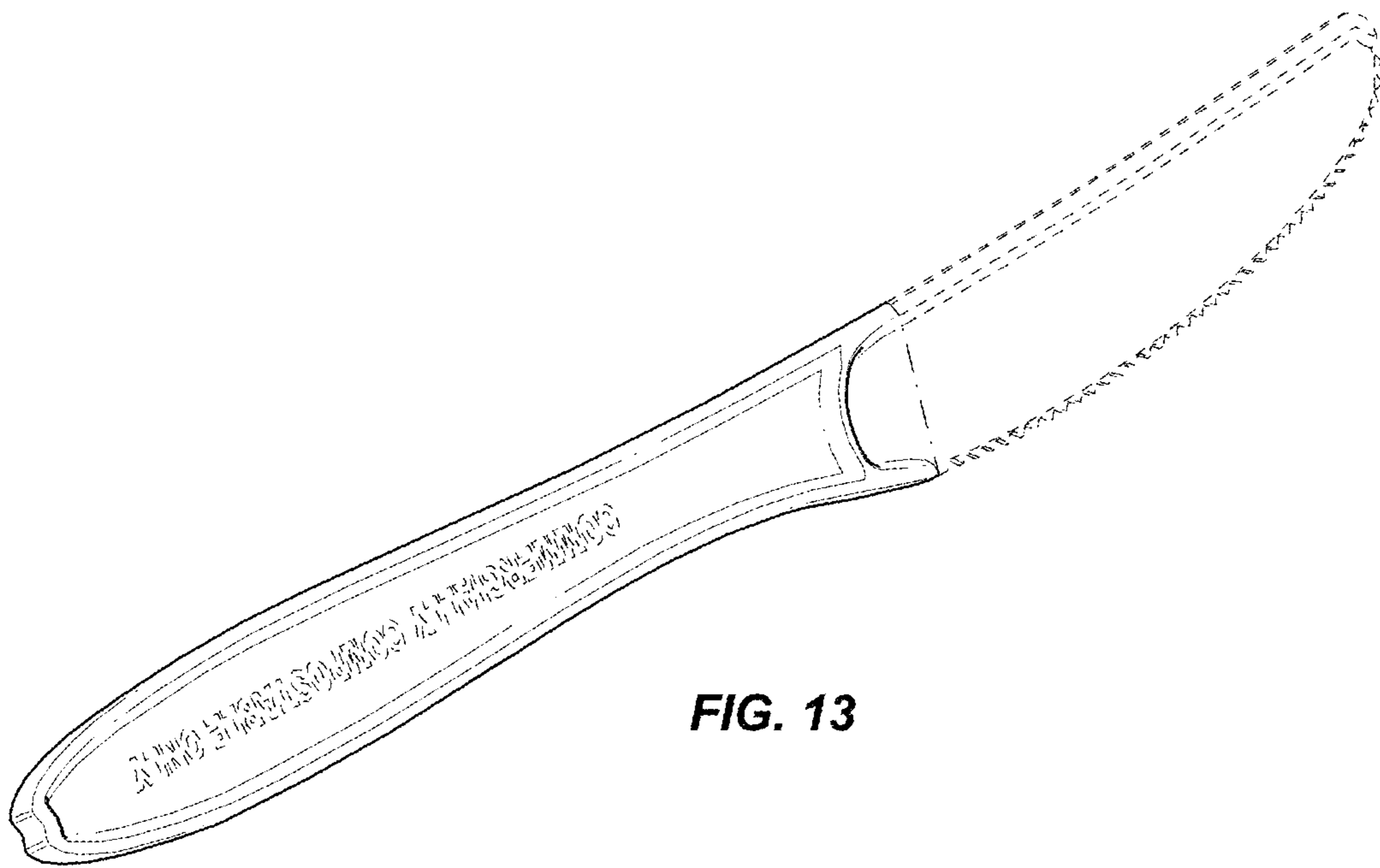

FIG. 13

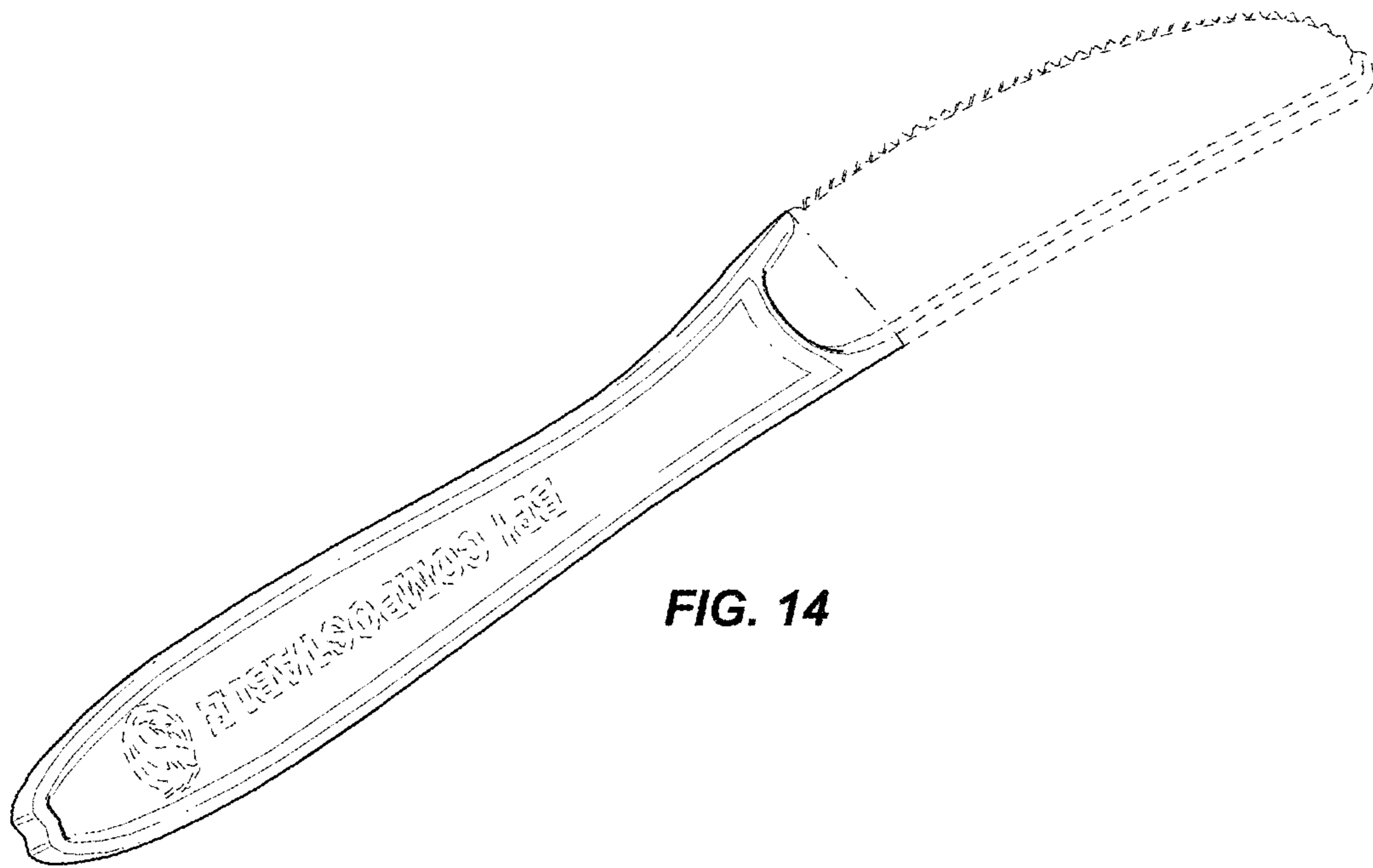

FIG. 14



FIG. 15



FIG. 16

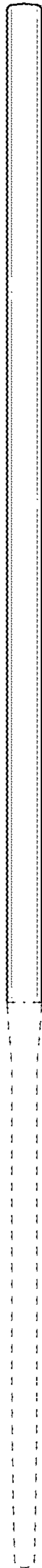

FIG. 17

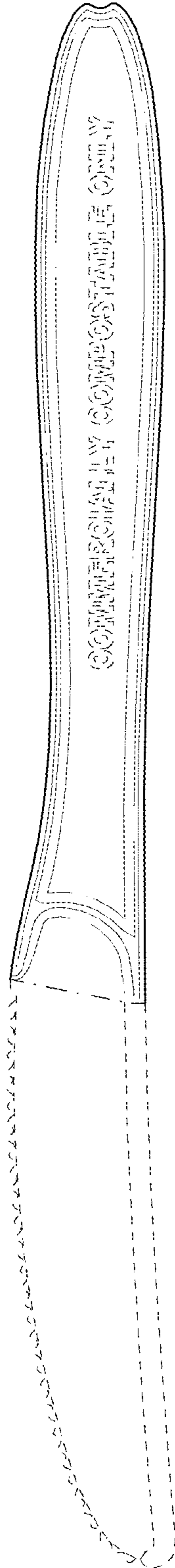

FIG. 18

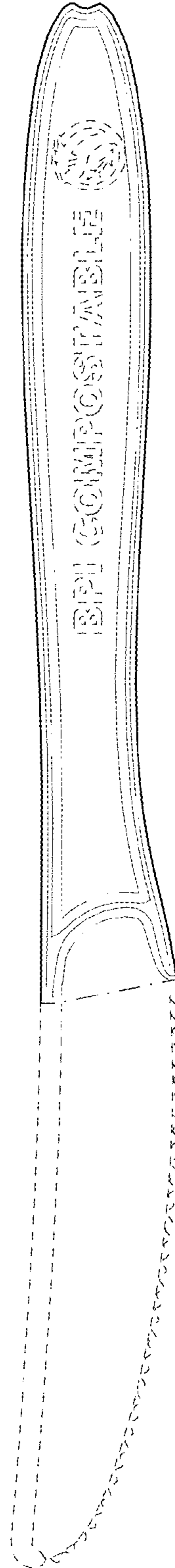

FIG. 19