



US00D963363S

(12) **United States Design Patent**
Shen

(10) **Patent No.:** **US D963,363 S**

(45) **Date of Patent:** **** Sep. 13, 2022**

(54) **HANGING CHAIR**

(71) Applicant: **NINGBO MINGHUANG HOME FURNISHING PRODUCTS CO., LTD**, Zhejiang (CN)

(72) Inventor: **Jiahuan Shen**, Zhejiang (CN)

(**) Term: **15 Years**

(21) Appl. No.: **29/769,427**

(22) Filed: **Feb. 5, 2021**

(51) **LOC (13) Cl.** **06-01**

(52) **U.S. Cl.**

USPC **D6/347**; D6/344

(58) **Field of Classification Search**

USPC D6/347, 344, 353, 360, 361, 369, 371, D6/374, 375, 385, 386, 387, 388, 389

CPC A47C 3/32; A47C 3/0255; A47C 3/023; A47C 31/02; A47C 4/06; A47C 4/30; A47C 4/42; A47C 7/22; A47C 7/32; A47C 7/666

See application file for complete search history.

(56) **References Cited**

U.S. PATENT DOCUMENTS

D297,685 S *	9/1988	Wilson	D6/333
4,915,120 A *	4/1990	Ziolkowski	A47C 7/66
				135/117
D532,343 S *	11/2006	Butler	D12/133
D549,981 S *	9/2007	Kreiss	D6/381
7,963,596 B2 *	6/2011	Efthimiou	A47C 7/66
				297/184.17
D706,044 S *	6/2014	Nassif	D6/347
D725,424 S *	3/2015	Cohen	D6/716.8
D804,200 S *	12/2017	Ka Hung	D6/333
2015/0335136 A1 *	11/2015	Wehner	A47C 4/045
				297/273

2016/0120323 A1 *	5/2016	Rivera	A47C 7/666
				135/147
2018/0228294 A1 *	8/2018	Beaulieu	A47C 4/28
2018/0249836 A1 *	9/2018	Wise	A47C 7/666
2020/0367653 A1 *	11/2020	Xuemin	A47C 3/0255

OTHER PUBLICATIONS

Design #008303507-0001, file date Dec. 1, 2020, Country code EU, Publication date Dec. 3, 2020, Ningbo Minghuang Home Furnishing Products Co., Ltd., creator Shen Jiahuan, found in orbit (Year: 2020).*

* cited by examiner

Primary Examiner — Mary Ann Calabrese
Assistant Examiner — Mark David Wolfley

(57) **CLAIM**

The ornamental design for a hanging chair, as shown and described.

DESCRIPTION

FIG. 1 is a front, top perspective view of a hanging chair, showing my new design;
FIG. 2 is a rear, bottom perspective view thereof;
FIG. 3 is a front elevation view thereof;
FIG. 4 is a rear elevation view thereof;
FIG. 5 is a left side elevation view thereof;
FIG. 6 is a right side elevation view thereof;
FIG. 7 is a top plan view thereof;
FIG. 8 is a bottom plan view thereof; and,
FIG. 9 is a perspective view thereof, shown within an environment of use.

The broken lines in the figures illustrate environment that form no part of the claimed design,

1 Claim, 9 Drawing Sheets

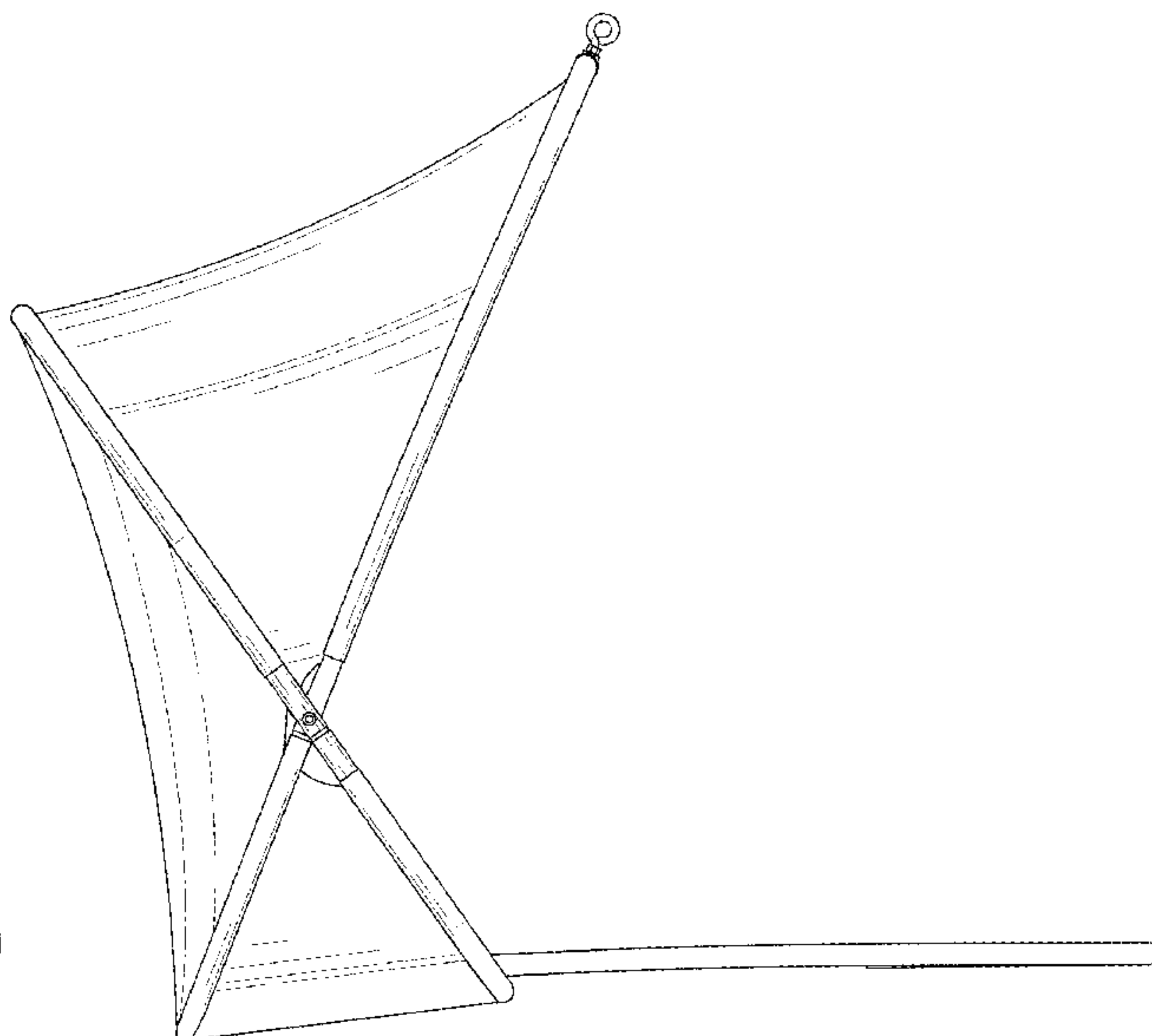
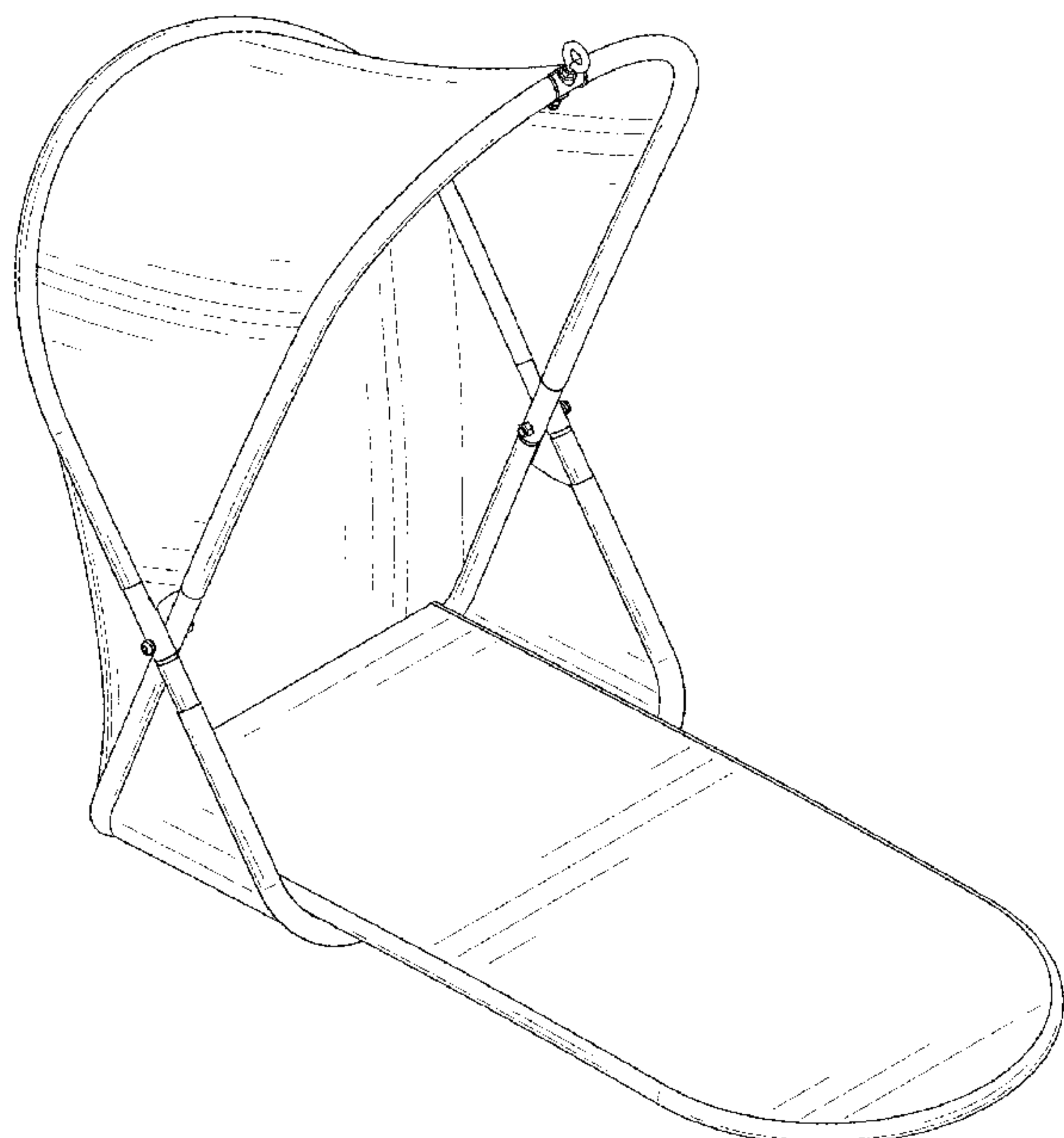

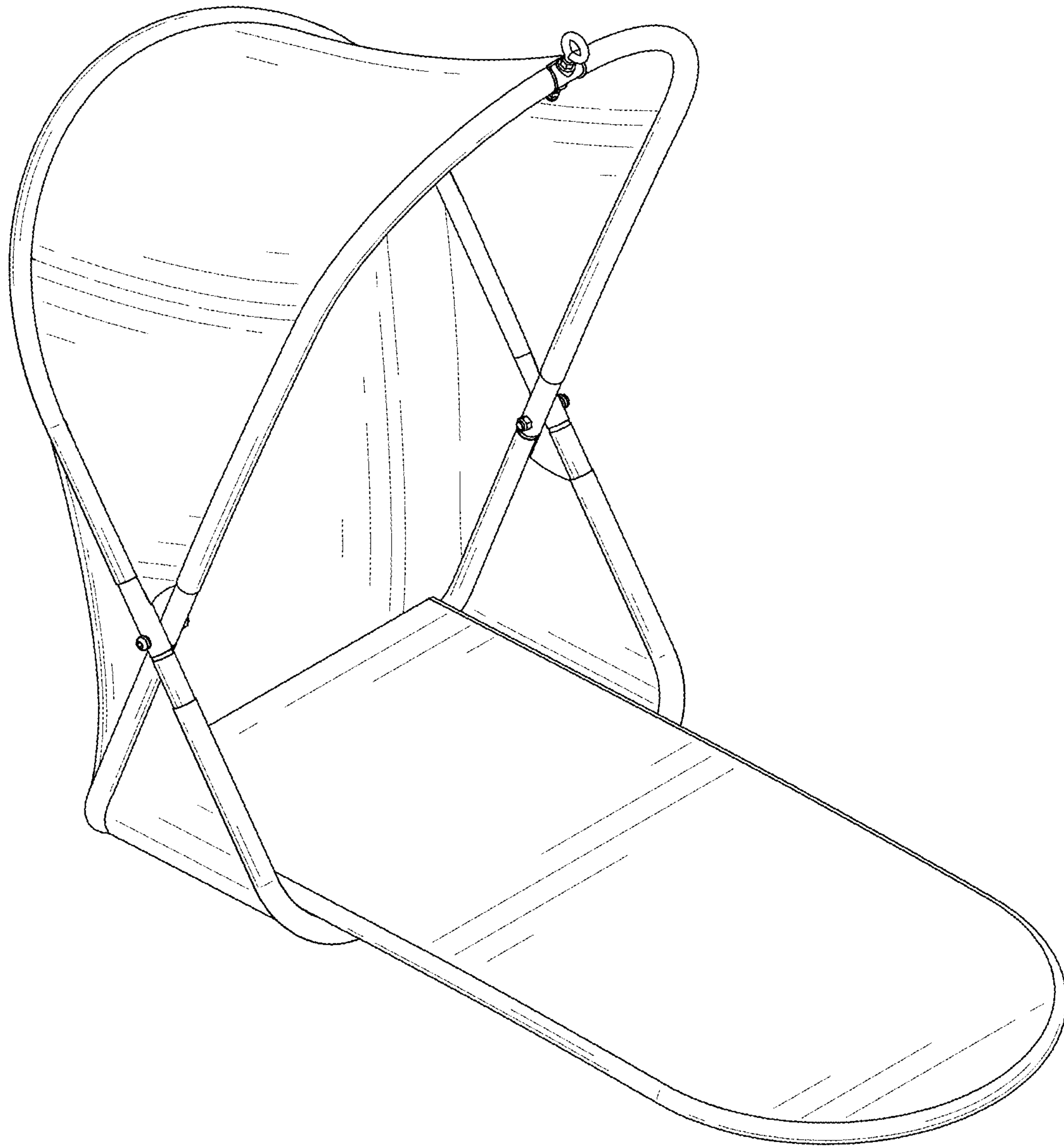

FIG. 1

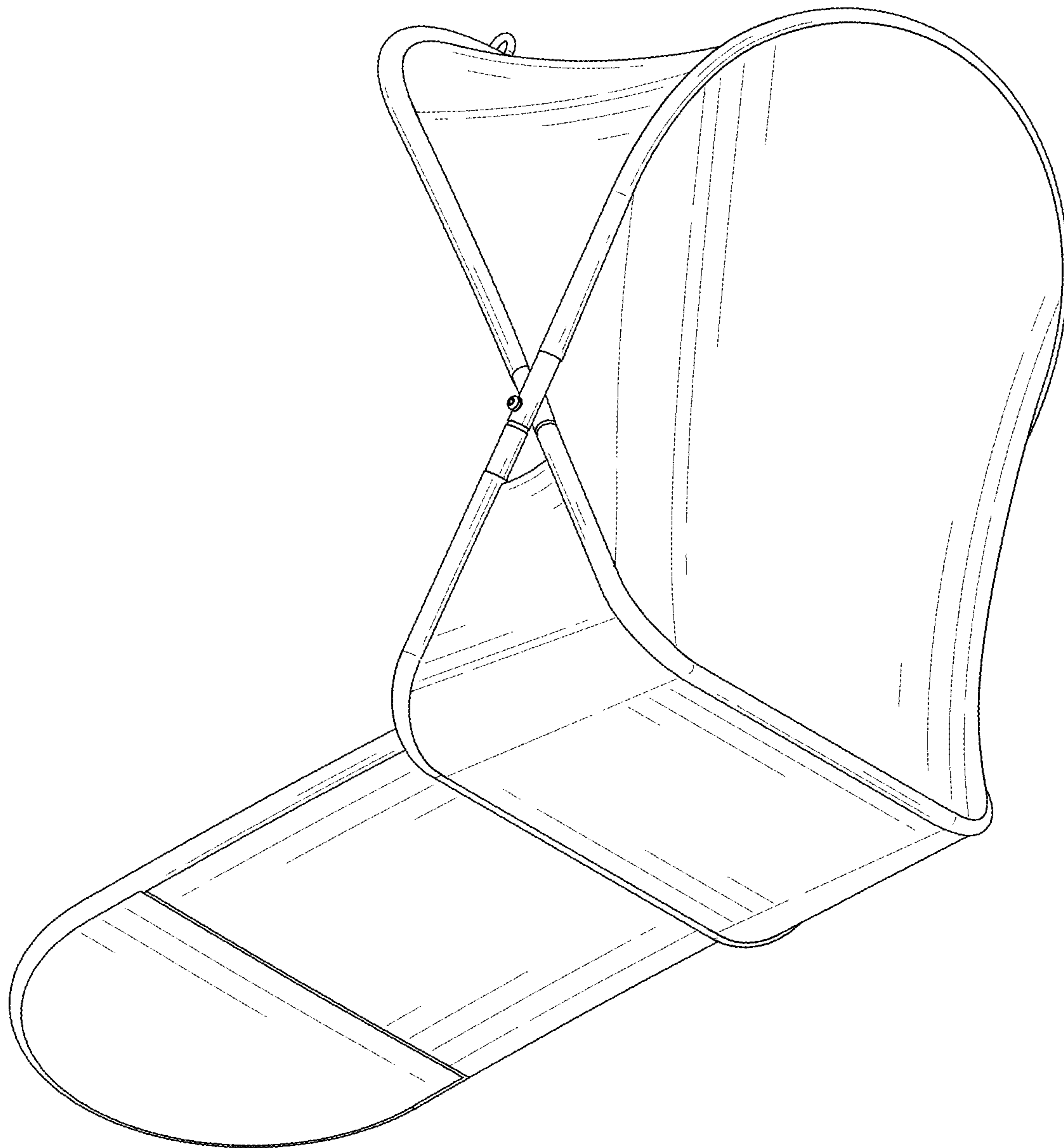

FIG. 2

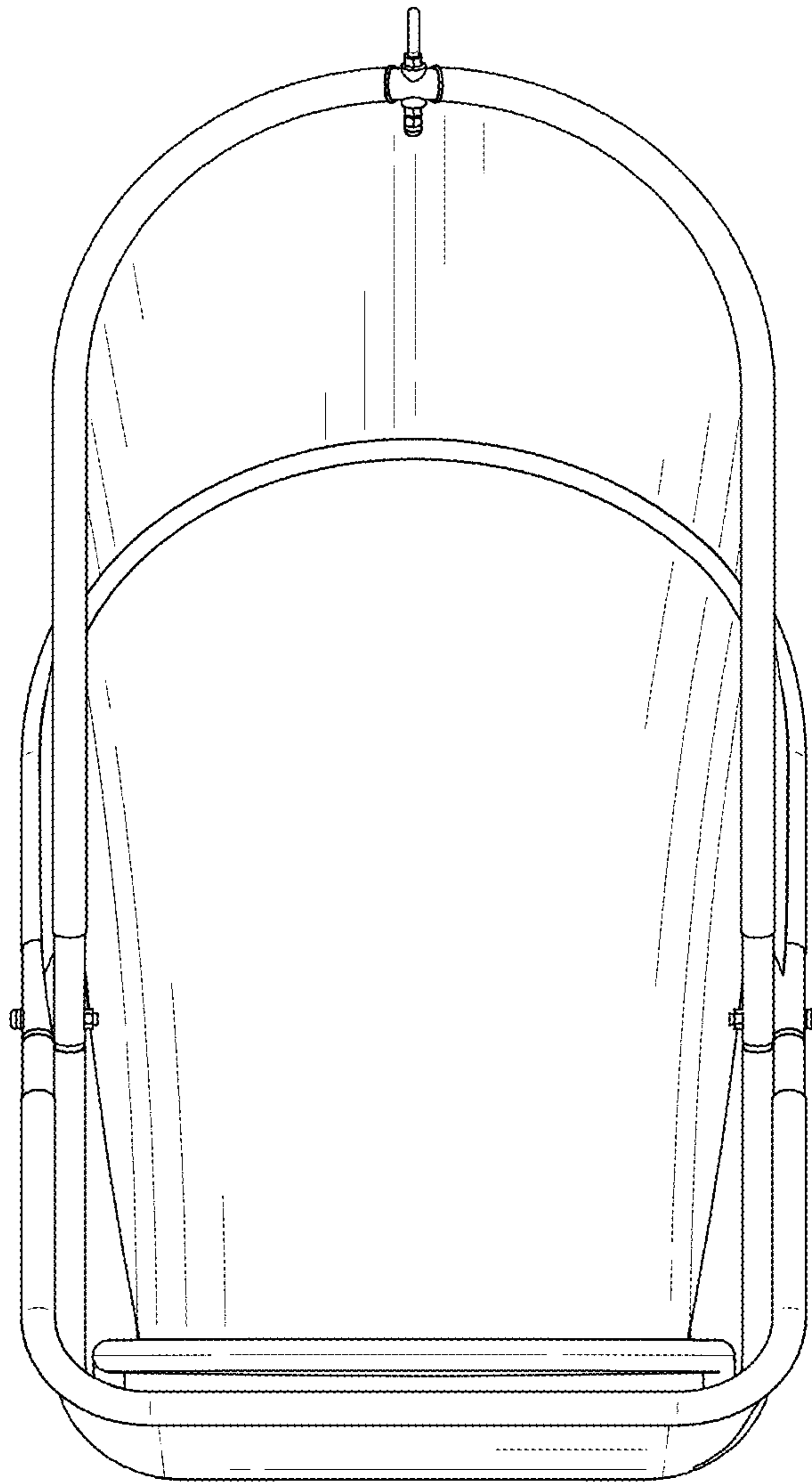

FIG. 3

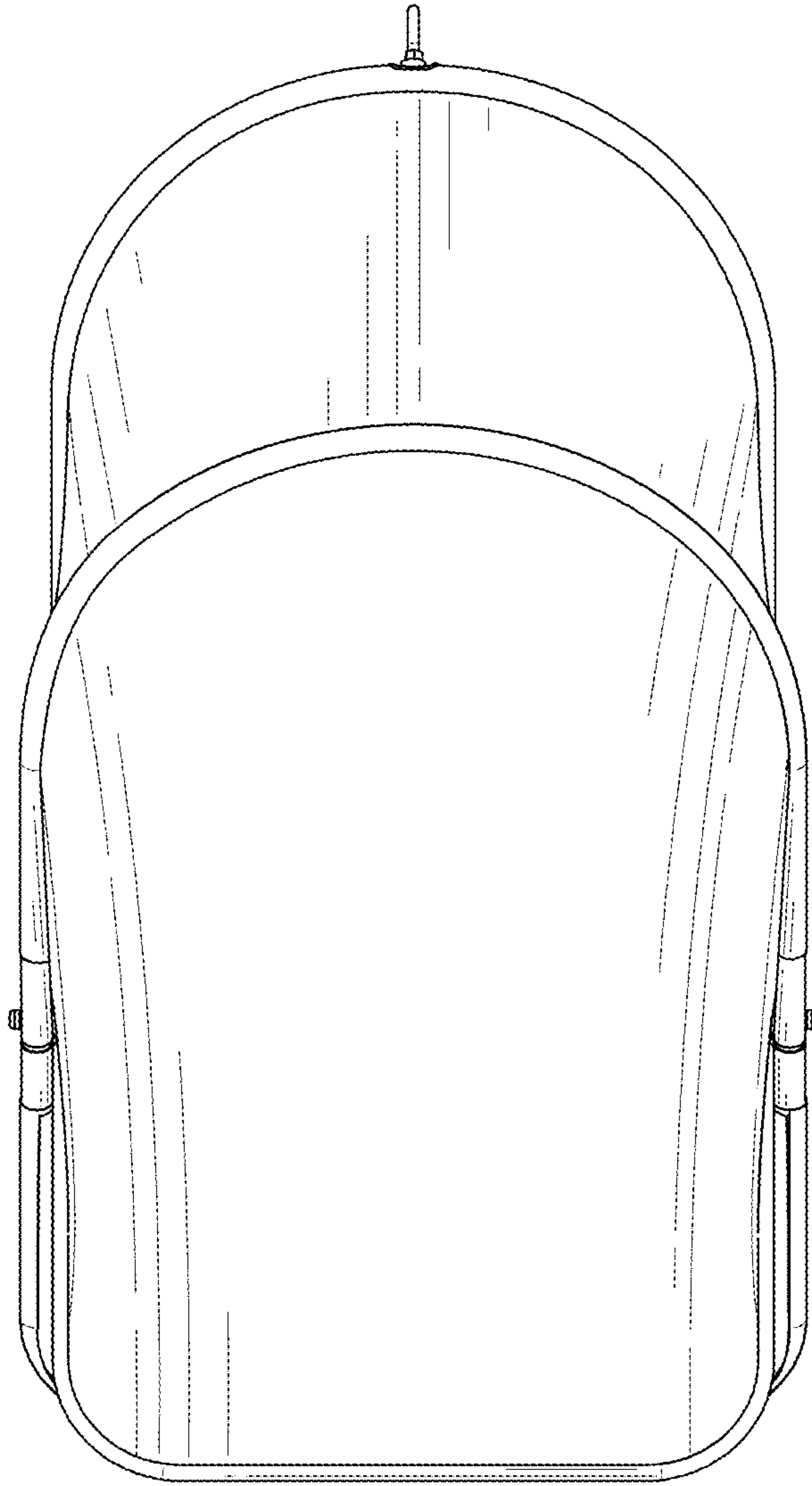

FIG. 4

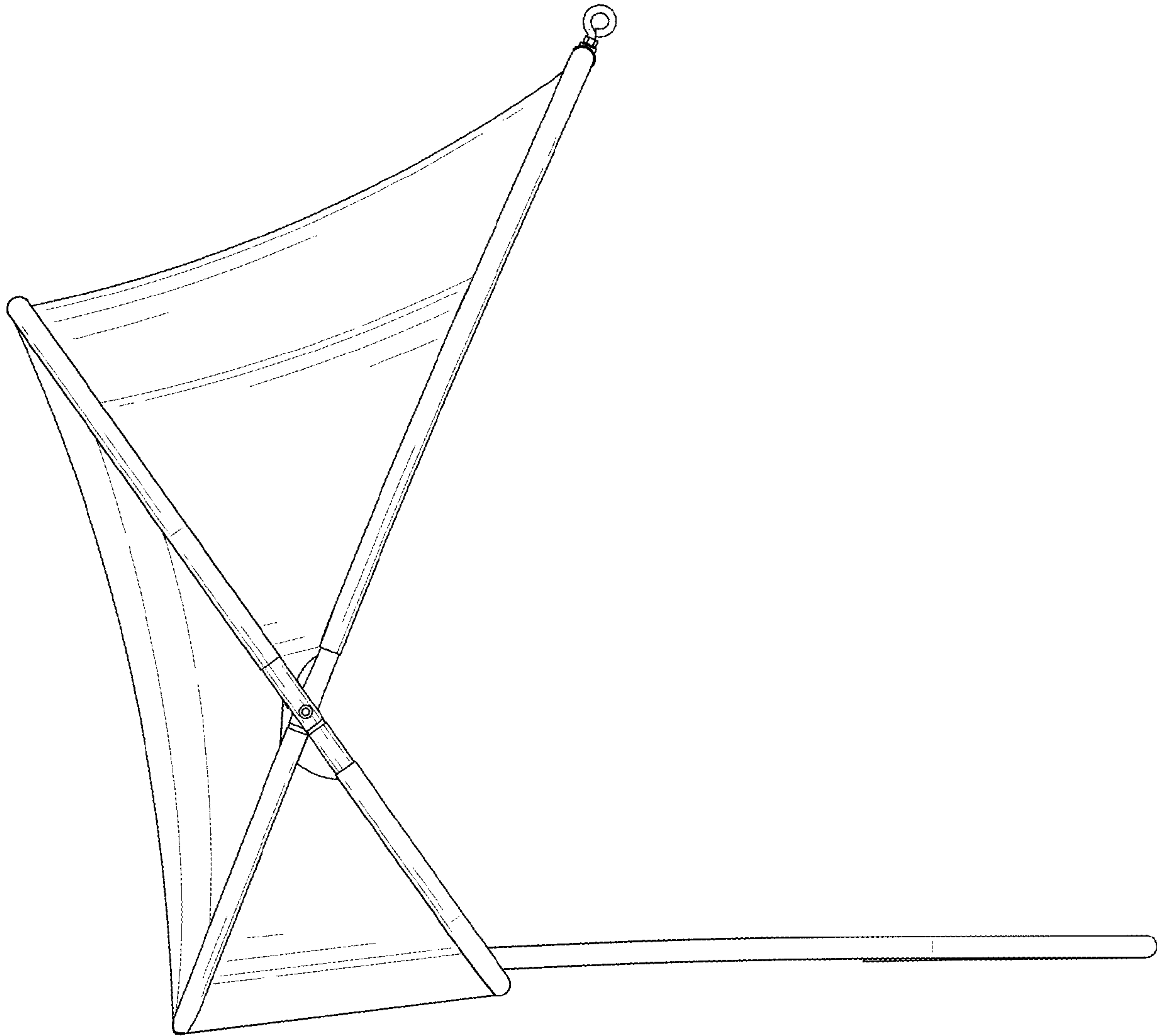

FIG. 5

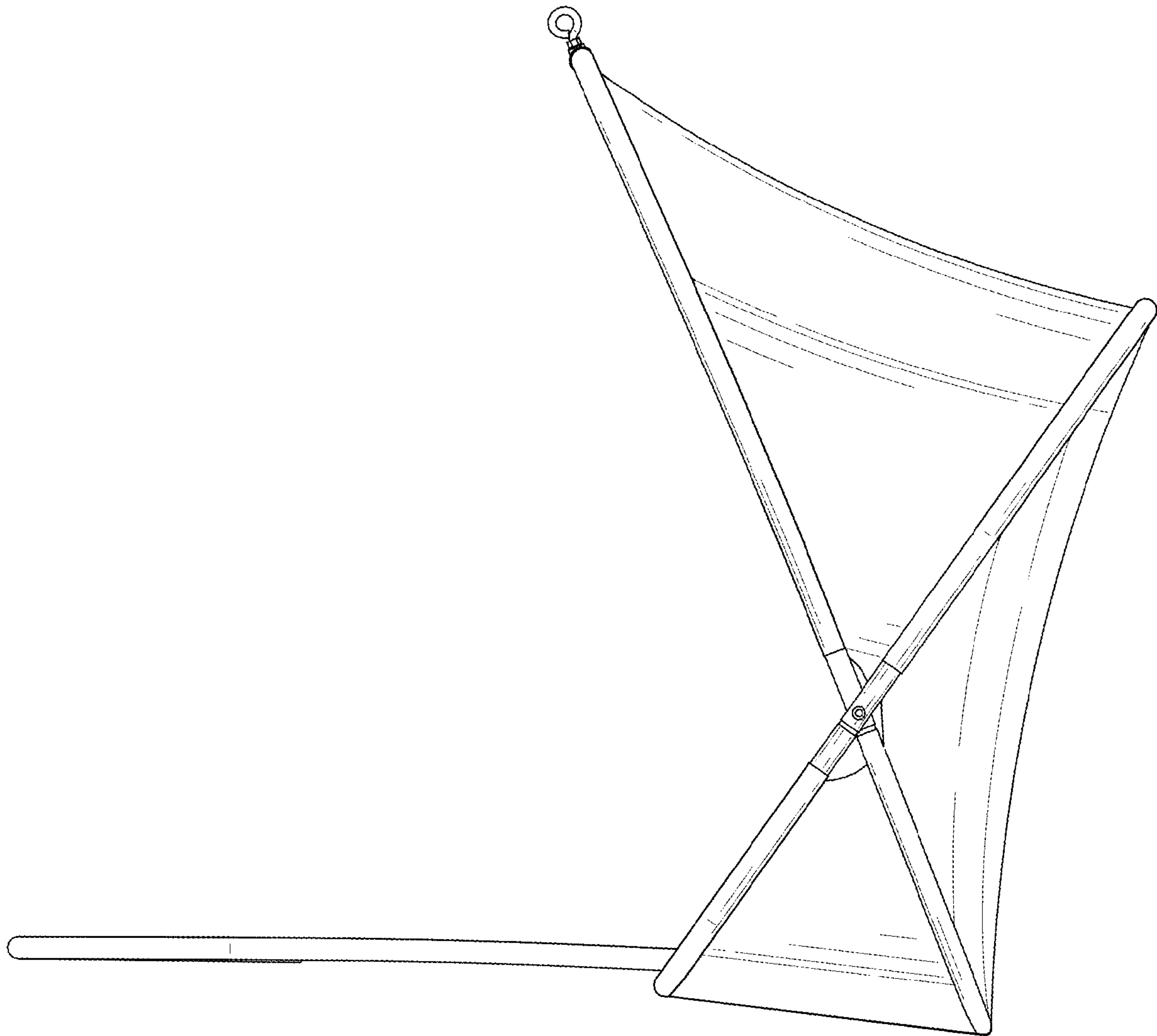

FIG. 6

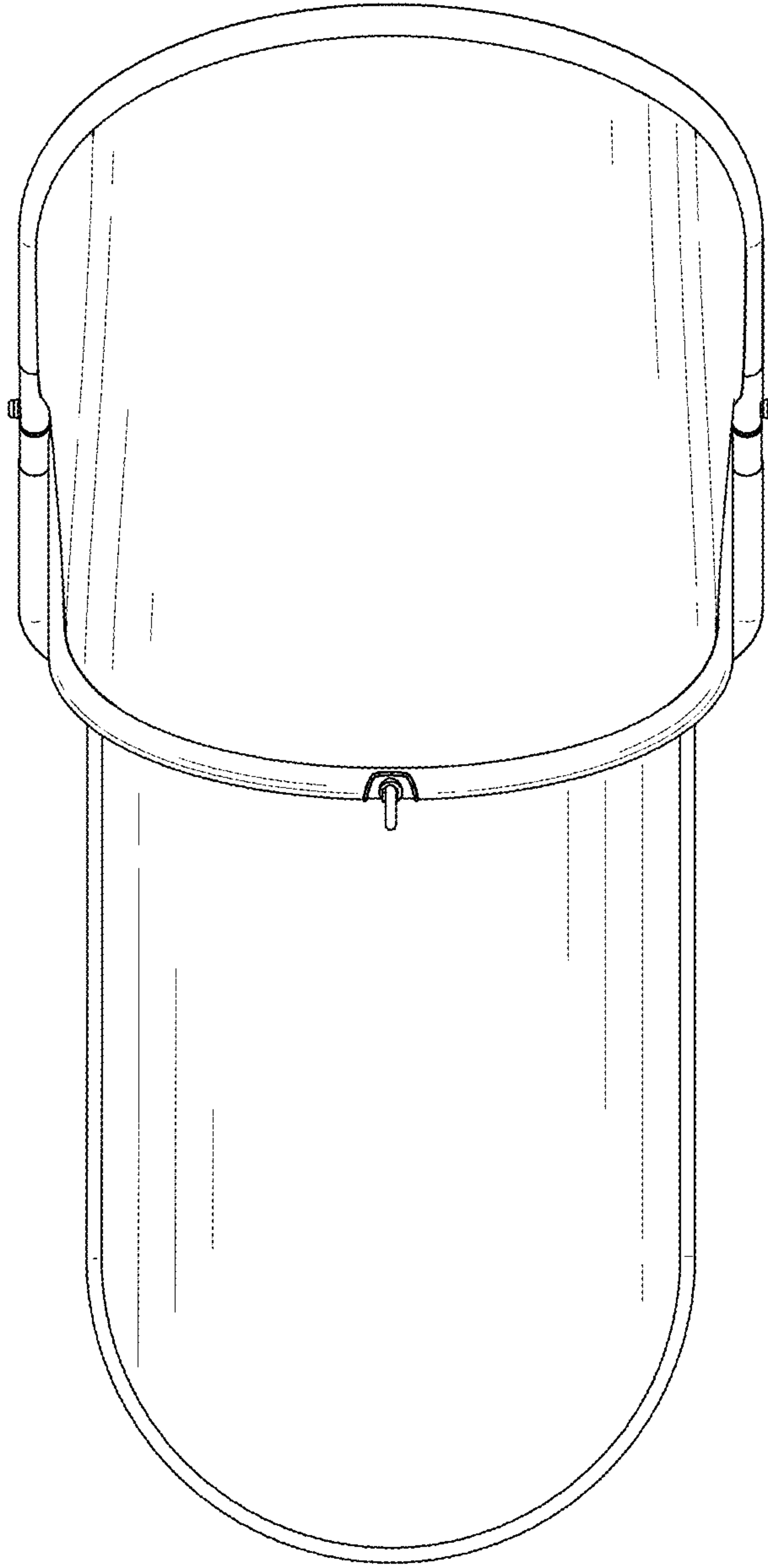

FIG. 7

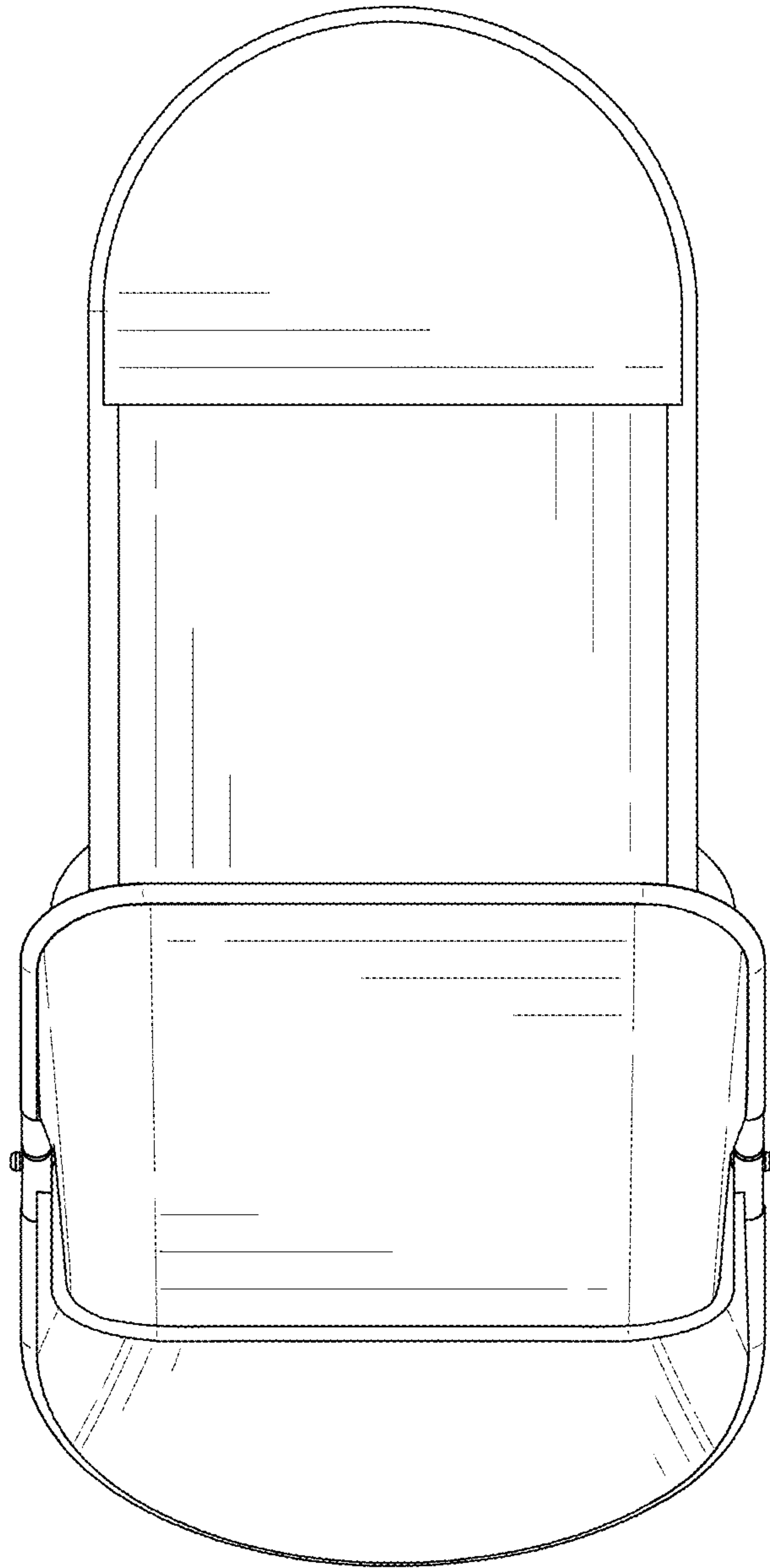

FIG. 8

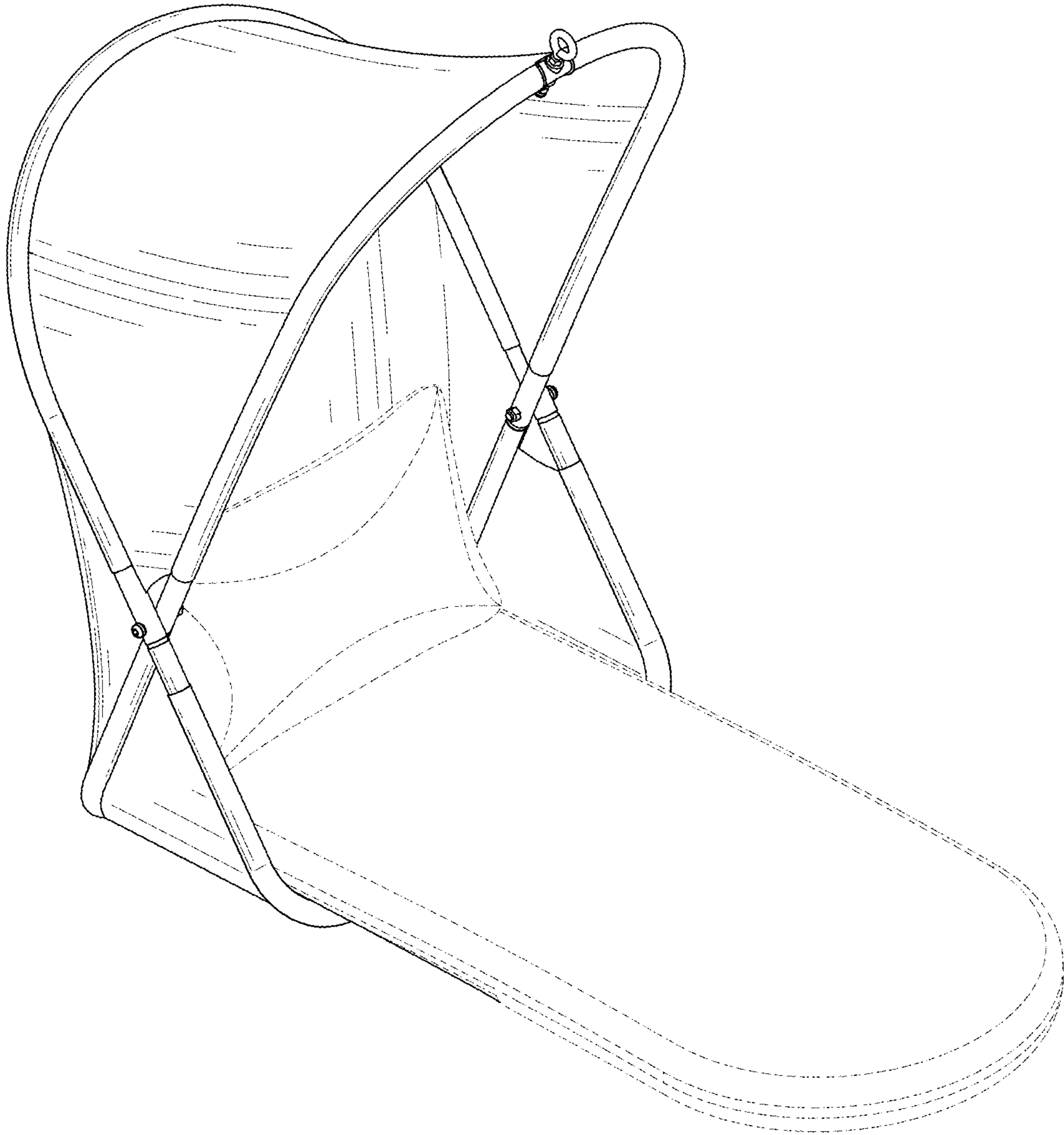

FIG. 9