

US00D963352S

(12) **United States Design Patent** (10) **Patent No.:** **US D963,352 S**
Scherer (45) **Date of Patent:** **** Sep. 13, 2022**

(54) **ROOM DIVIDER**
(71) Applicant: **Premium Home Decor LLC**, Maynard, MA (US)
(72) Inventor: **Matthew L. Scherer**, Maynard, MA (US)
(73) Assignee: **Premium Home Decor LLC**, Maynard, MA (US)
(**) Term: **15 Years**
(21) Appl. No.: **29/730,567**
(22) Filed: **Apr. 6, 2020**
(51) **LOC (13) Cl.** **06-06**
(52) **U.S. Cl.**
USPC **D6/332**
(58) **Field of Classification Search**
USPC D6/643, 714, 332
CPC E04B 2002/7483; E04B 2002/7498; E04B 2/76; E04B 2/7401; A47B 2200/12; A47B 17/00; E04C 2/54
See application file for complete search history.

7,874,090 B2 * 1/2011 Flagg G09F 15/0068 211/175
D641,560 S * 7/2011 Thompson D6/332
D681,965 S * 5/2013 Pili D6/332
9,615,681 B2 * 4/2017 Göranson E04B 2/7427
9,622,602 B2 * 4/2017 Potter E06B 7/30
10,004,332 B2 * 6/2018 Garrett-Lindsey A47B 97/00
10,221,618 B2 * 3/2019 Pedersen E05B 65/0014

* cited by examiner

Primary Examiner — Doris Clark

(74) *Attorney, Agent, or Firm* — Hamilton, Brook, Smith & Reynolds, P.C.

(57) **CLAIM**

The ornamental designs for a room divider, as shown and described.

DESCRIPTION

FIG. 1 is a perspective view of a first embodiment of a room divider showing my new design.
FIG. 2 is a front elevation view.
FIG. 3 is a rear elevation view.
FIG. 4 is a top plan view.
FIG. 5 is a bottom plan view.
FIG. 6 is a side view.
FIG. 7 is the opposite side view.
FIG. 8 is a perspective view of a second embodiment of a room divider showing my new design.
FIG. 9 is a front elevation view.
FIG. 10 is a rear elevation view.
FIG. 11 is a top plan view.
FIG. 12 is a bottom plan view.
FIG. 13 is a side view; and,
FIG. 14 is the opposite side view.

(56) **References Cited**

U.S. PATENT DOCUMENTS

D191,905 S	12/1961	Haywood	
D323,944 S	2/1992	Maas	
D330,646 S	11/1992	Maas	
D345,018 S	3/1994	Maas	
D422,797 S *	4/2000	Vincent	D6/332
D455,016 S	4/2002	Newhouse	
D460,277 S *	7/2002	Lee	D6/332
D562,990 S *	2/2008	Yeager	D25/58
7,753,100 B2 *	7/2010	Luomanen	A47H 21/00
			160/199

1 Claim, 14 Drawing Sheets

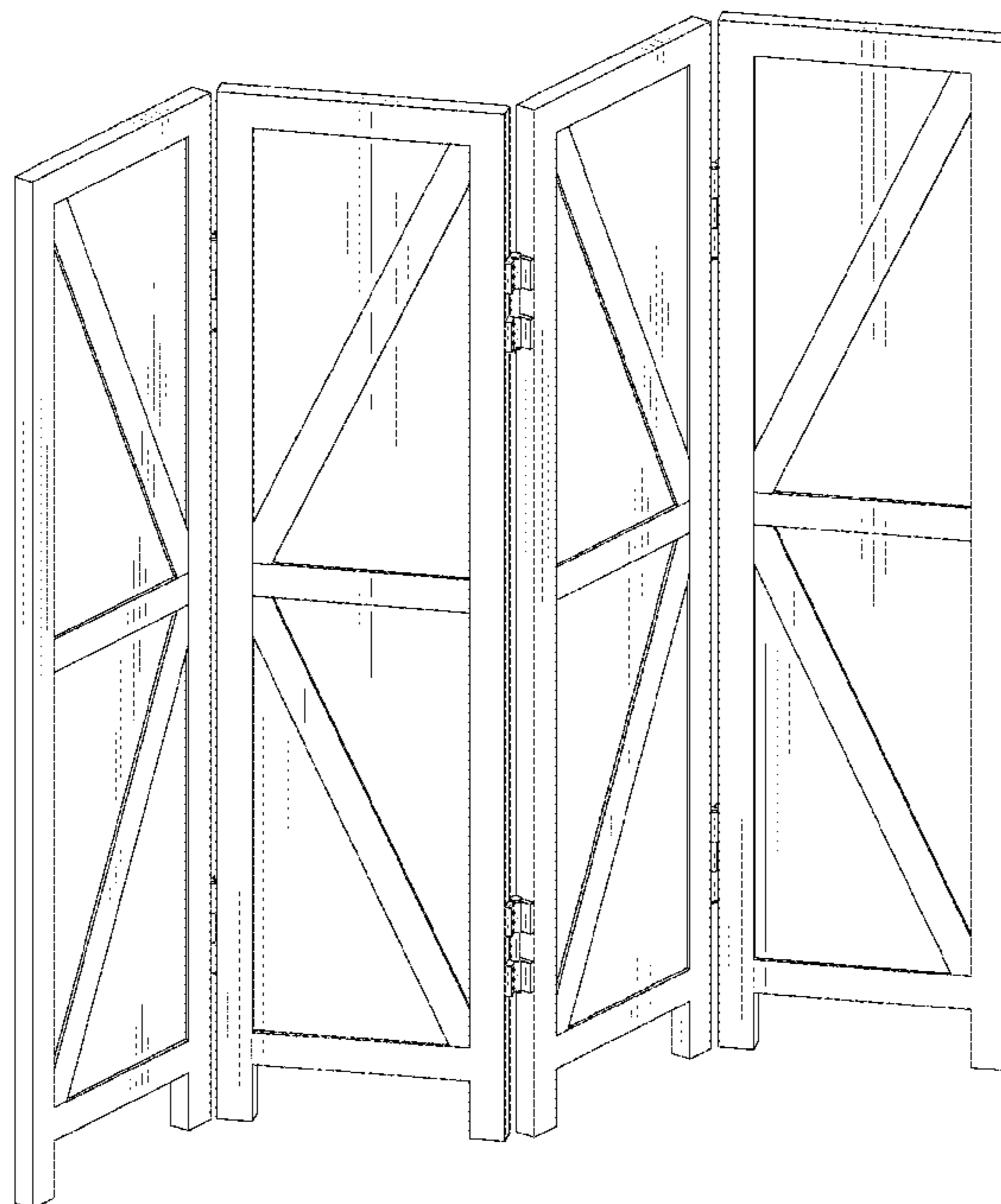

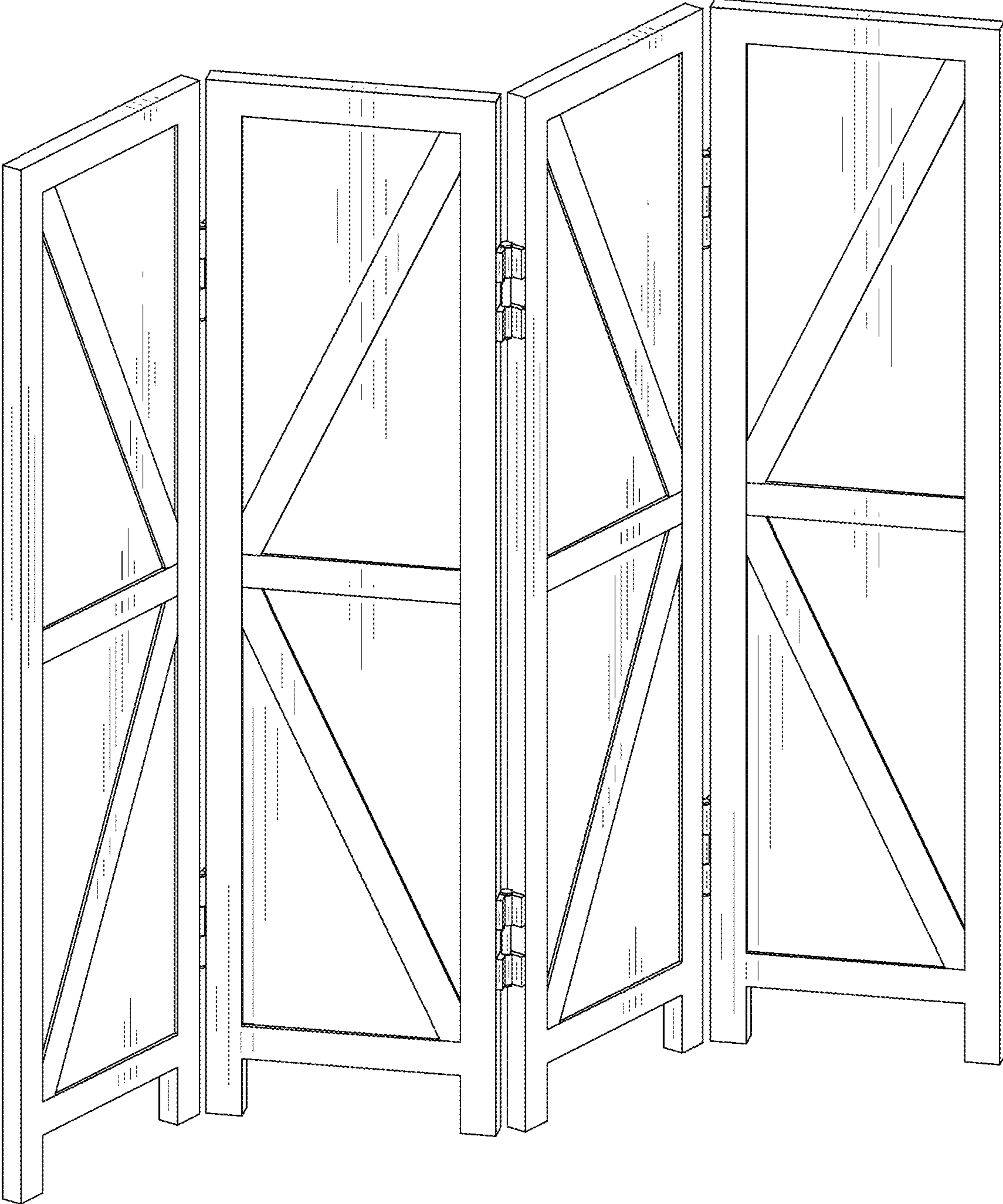

FIG. 1

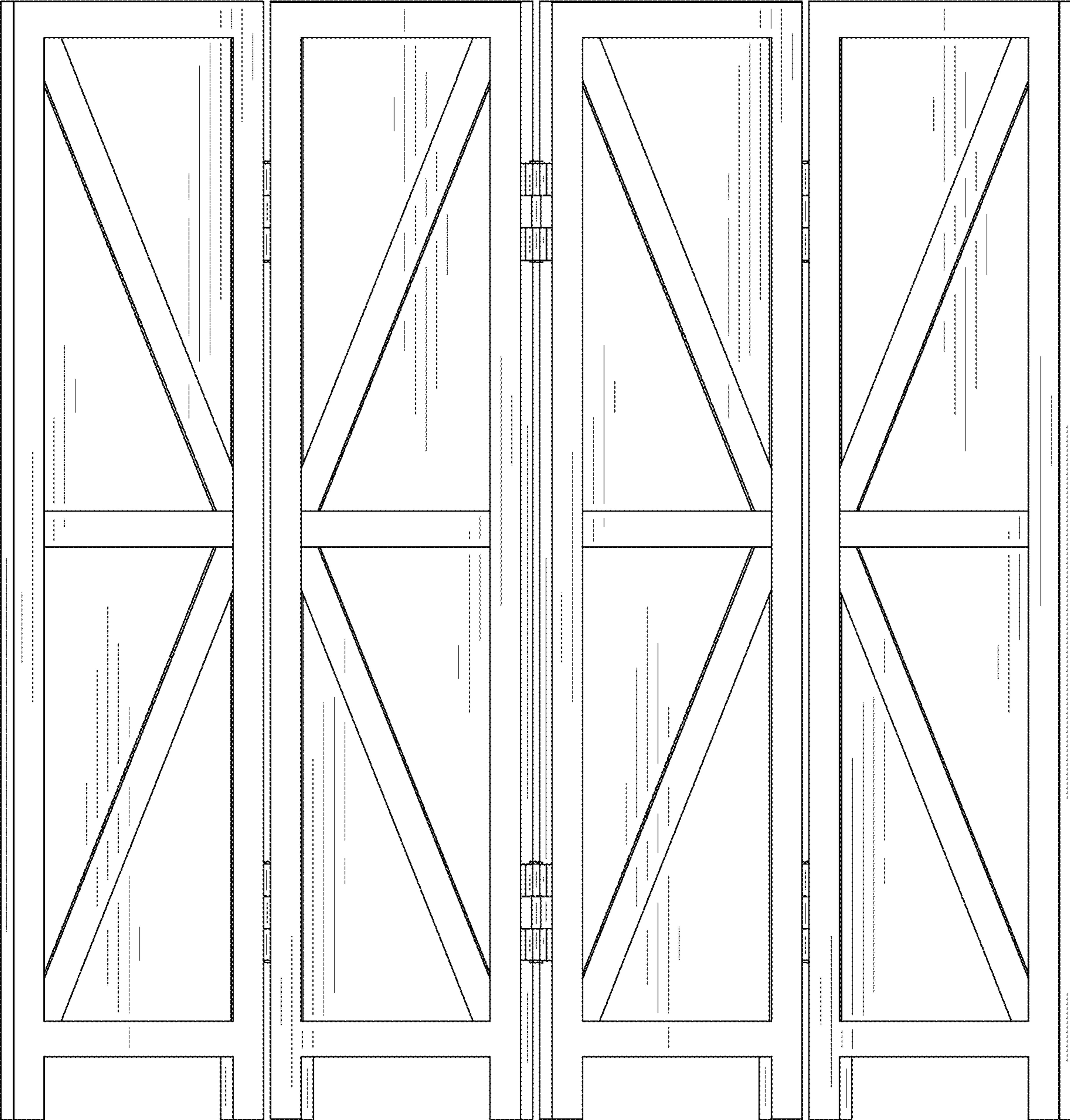

FIG. 2

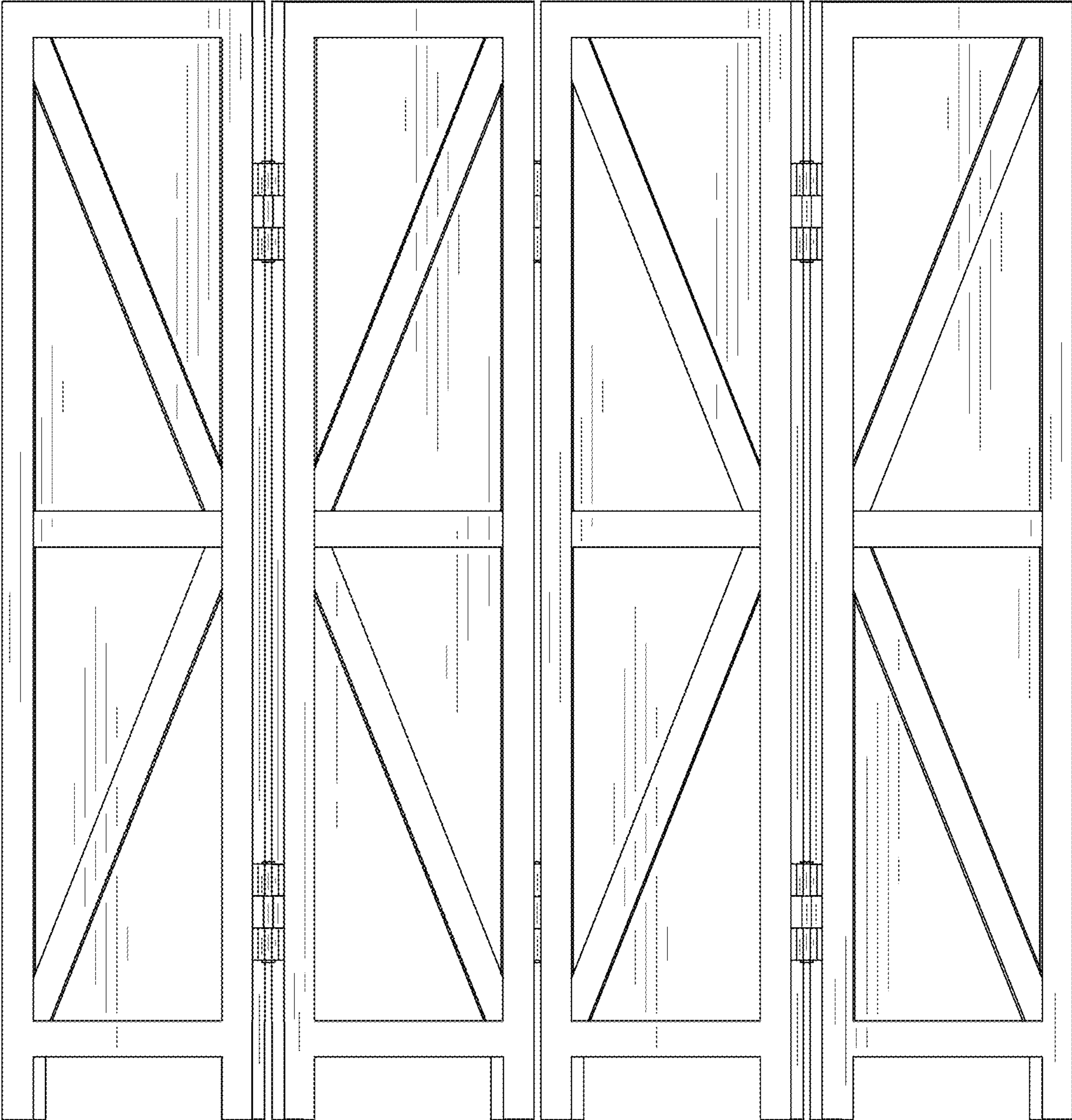

FIG. 3

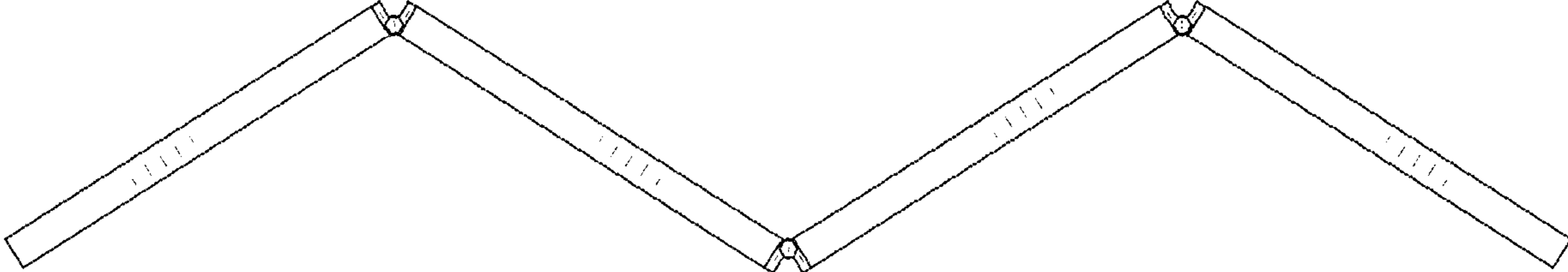

FIG. 4

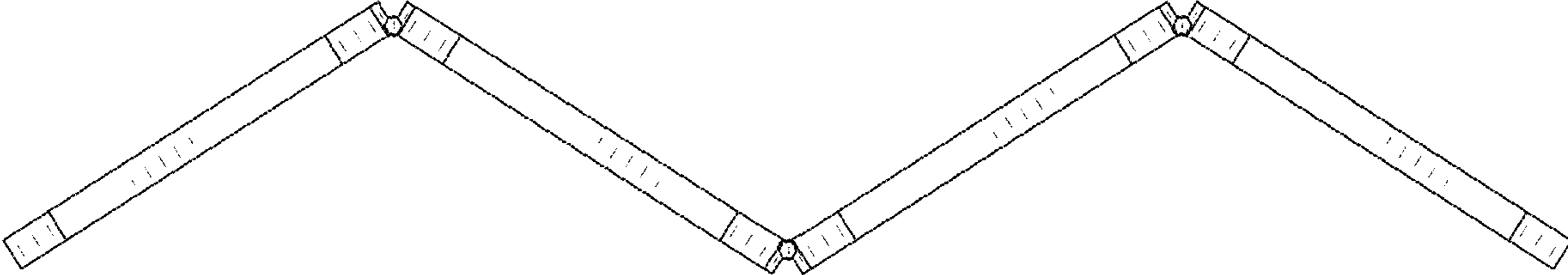

FIG. 5

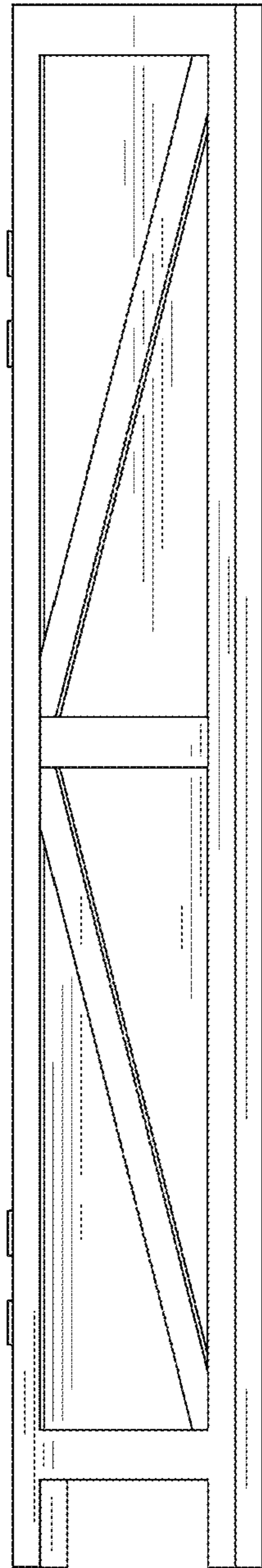

FIG. 6

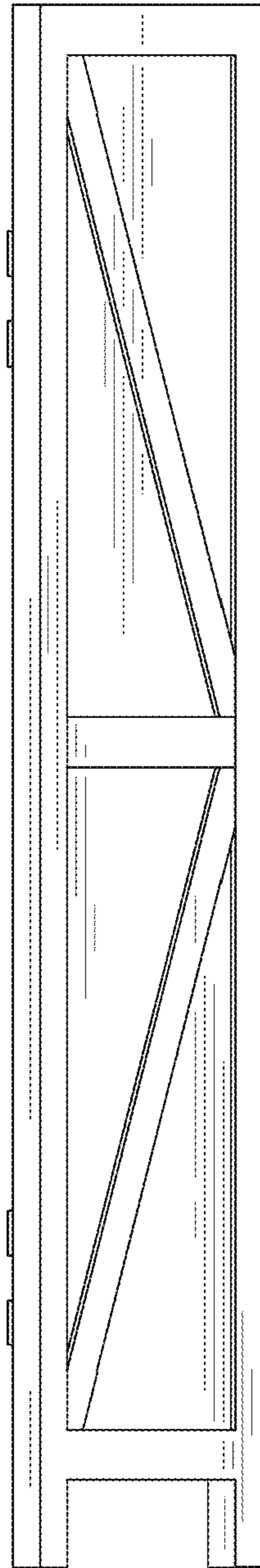

FIG. 7

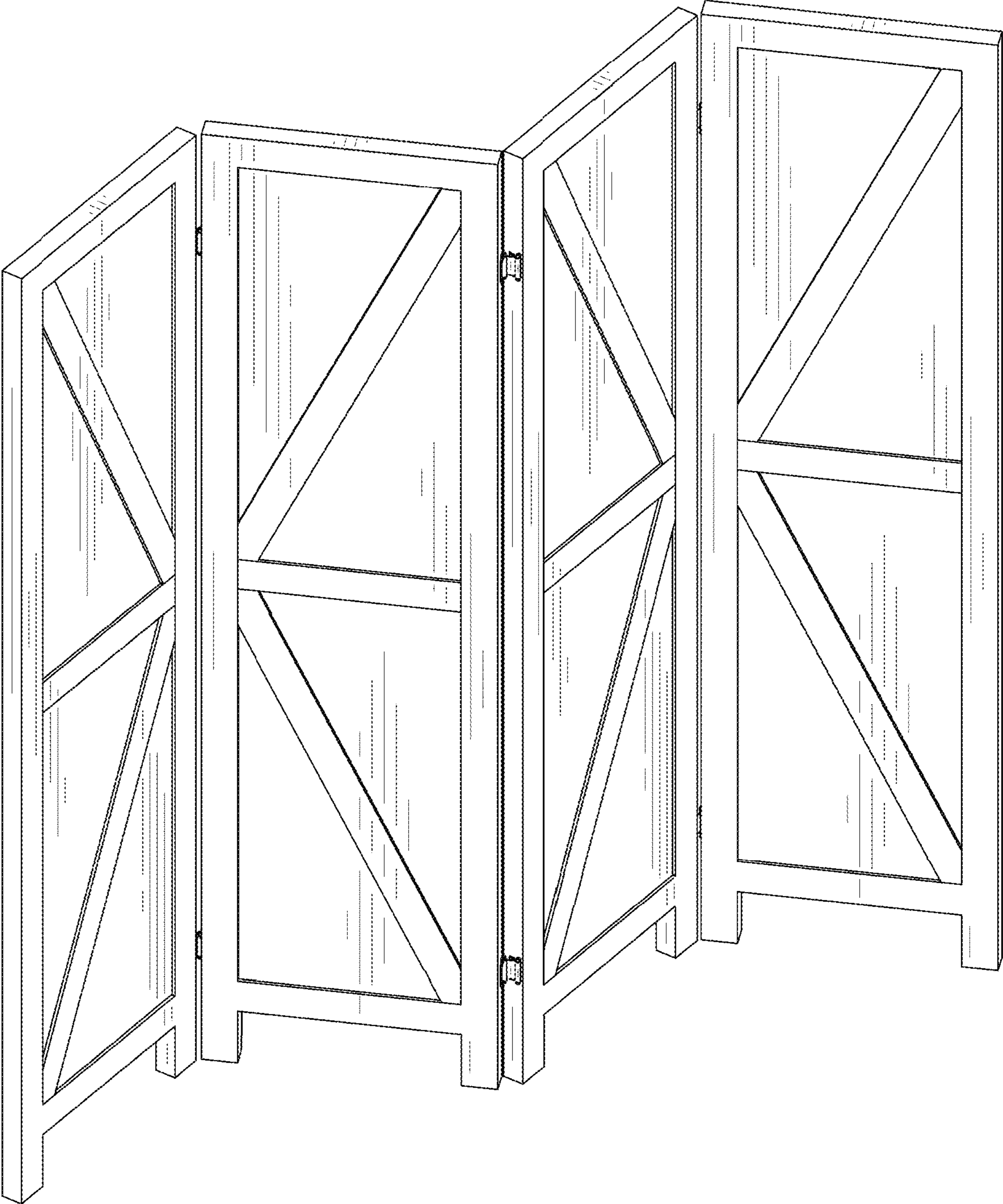

FIG. 8

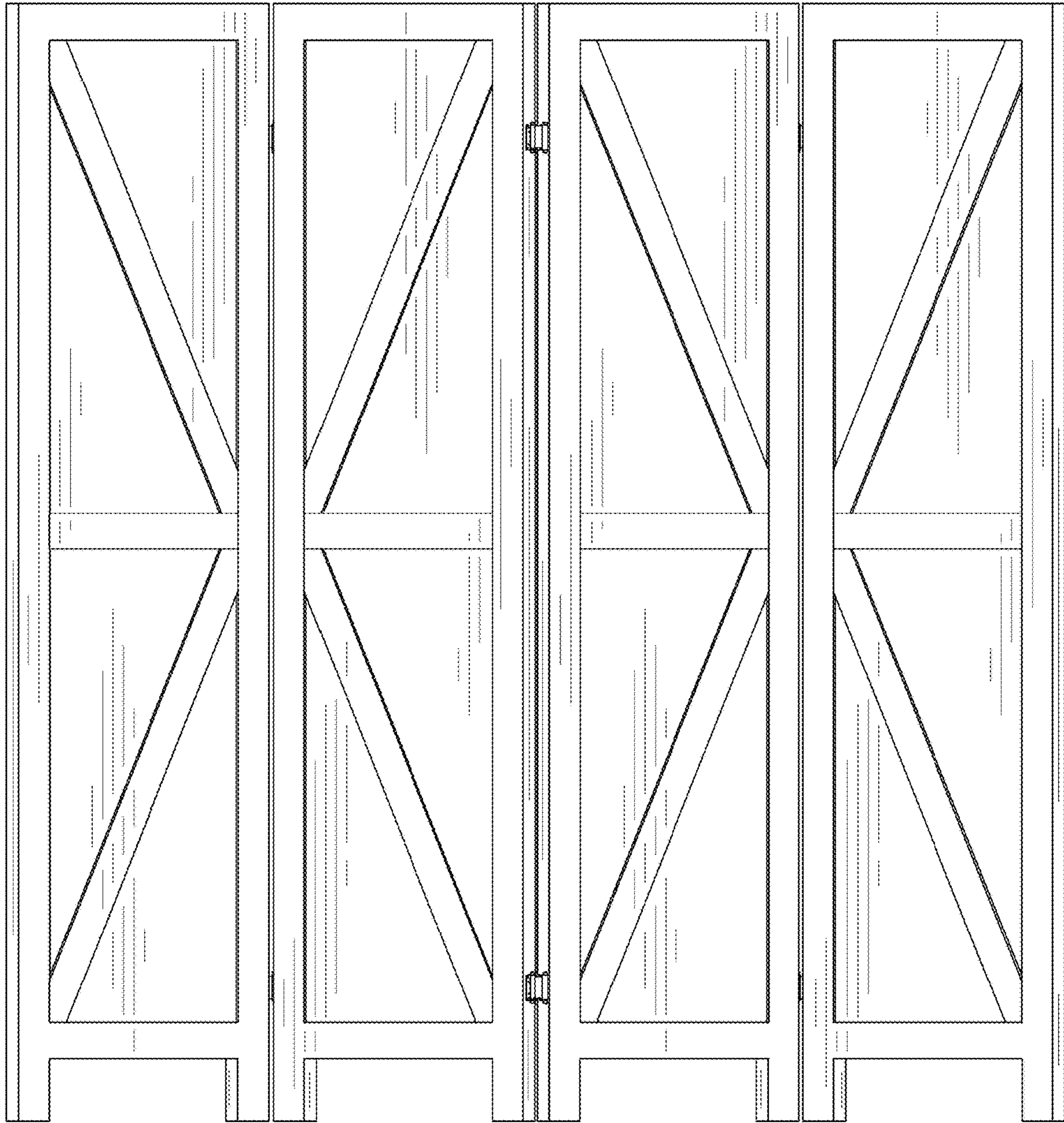

FIG. 9

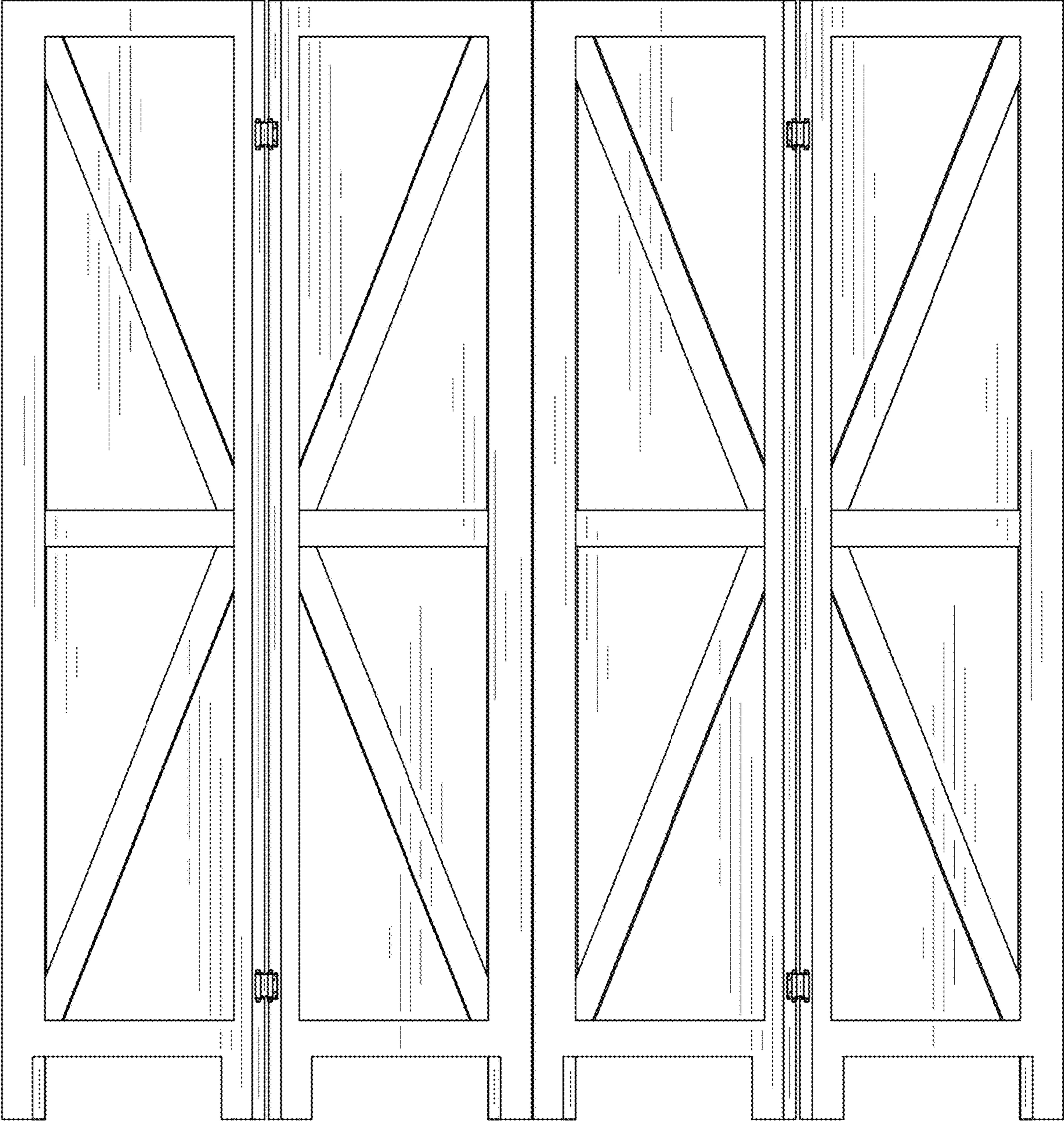

FIG. 10

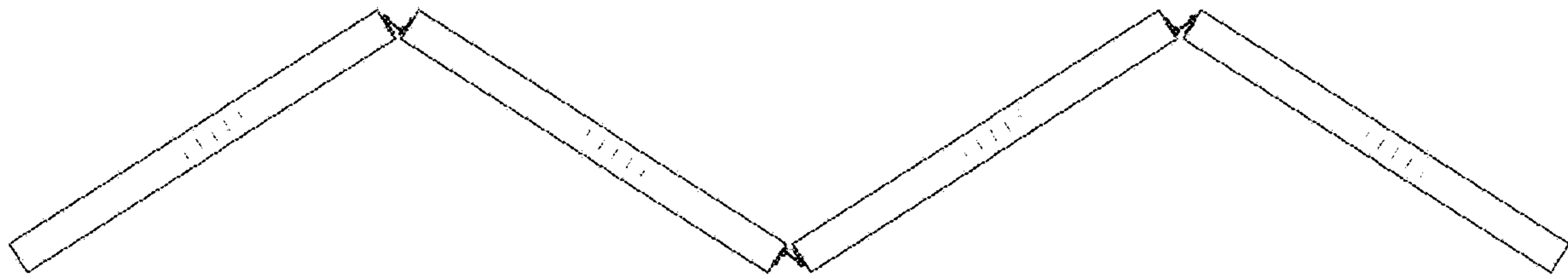

FIG. 11

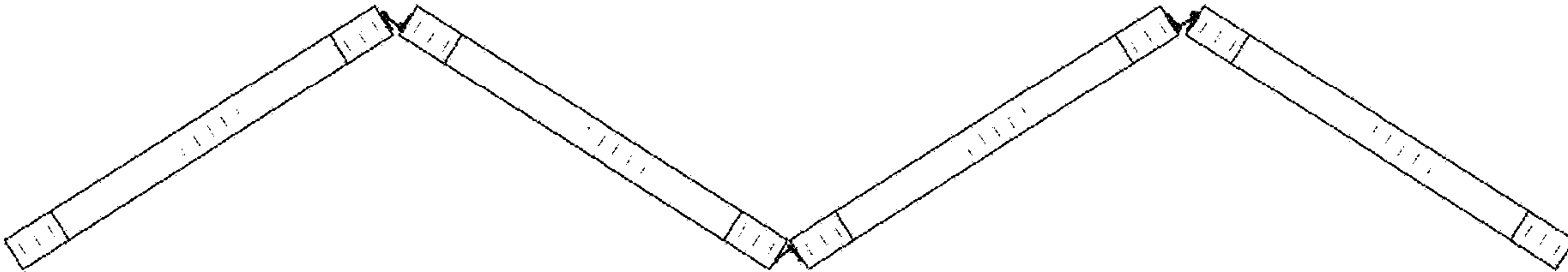

FIG. 12

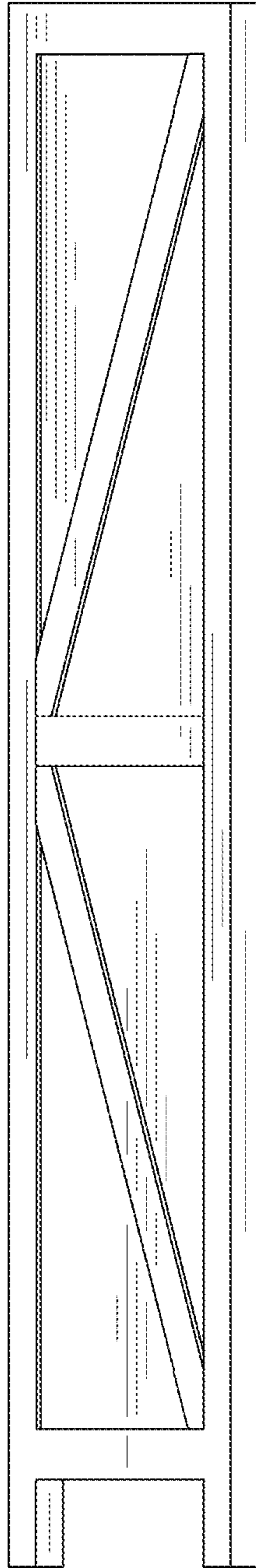

FIG. 13

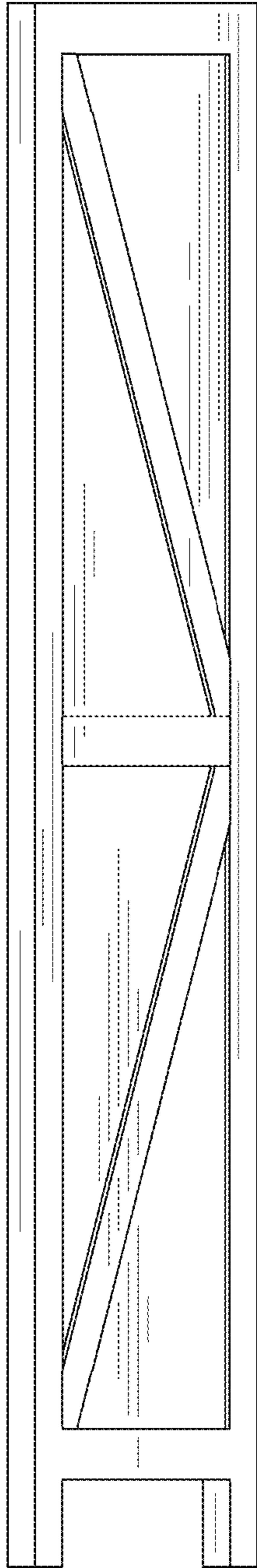

FIG. 14