



US00D963340S

(12) **United States Design Patent** (10) **Patent No.:** **US D963,340 S**
Zhu (45) **Date of Patent:** **** Sep. 13, 2022**

(54) **CASE**

(71) Applicant: **Dengfeng Zhu**, Zhangjiajie (CN)

(72) Inventor: **Dengfeng Zhu**, Zhangjiajie (CN)

(**) Term: **15 Years**

(21) Appl. No.: **29/782,745**

(22) Filed: **May 8, 2021**

(51) **LOC (13) Cl.** **03-01**

(52) **U.S. Cl.**

USPC **D3/301**

(58) **Field of Classification Search**

USPC D3/276, 282, 289, 295, 301, 302, 294

CPC Y10S 190/903; A45C 2011/003

See application file for complete search history.

(56) **References Cited**

U.S. PATENT DOCUMENTS

D427,764 S *	7/2000	Conway	D3/203.5
D547,054 S *	7/2007	Kavovit	D3/217
D666,414 S *	9/2012	Giovannoni	D3/279
D668,039 S *	10/2012	Graham	D3/226
D733,429 S *	7/2015	Grenier	D3/905
D734,027 S *	7/2015	Noble	D3/254
D803,563 S *	11/2017	Leblanc	D3/901
D805,775 S *	12/2017	Tsai	D3/905
D816,985 S *	5/2018	Cheung	D3/217
D874,823 S *	2/2020	Christen	D3/905
D877,510 S *	3/2020	Christen	D3/905
D880,860 S *	4/2020	Liu	D9/702
D907,920 S	1/2021	Li		

OTHER PUBLICATIONS

Kixar VR Hard Carrying Case, announced Jun. 27, 2014 [online], [site visited Feb. 14, 2022]. Available from internet, URL: <https://

www.amazon.com/Carrying-Compatible-Official-Controllers-Accessories-Shockproof/dp/B0969992B5/> (Year: 2014).*

Vanerdun Oculus Quest Travel Case, announced Jun. 26, 2019 [online], [site visited Feb. 14, 2022]. Available from internet, URL: <https://www.amazon.com/Vanerdun-Oculus-Quest-Gaming-Headset/dp/B07TNHHS4M> (Year: 2019).*

MOSISO Camera Backpack, announced Dec. 3, 2019 [online], [site visited Feb. 14, 2022]. Available from internet, URL: <https://www.amazon.com/MOSISO-Mirrorless-Photography-Waterproof-Compartment/dp/B07ZCRWPPV/> (Year: 2019).*

Homvare Hard Headphone Case, announced Oct. 17, 2019 [online], [site visited Feb. 14, 2022]. Available from internet, URL: <https://www.amazon.com/Homvare-Compatible-Audio-Technica-Sennheiser-Panasonic/dp/B07Z89SQBC/> (Year: 2019).*

Surf to Summit Molded Case, announced Oct. 23, 2020 [online], [site visited Feb. 14, 2022]. Available from internet, URL: <https://www.amazon.com/Aviation-Headsets-Headphones-Headset-Protector/dp/B00LCJIRB2/> (Year: 2020).*

* cited by examiner

Primary Examiner — Kevin K Rudzinski

Assistant Examiner — Amber J Rabie

(74) *Attorney, Agent, or Firm* — Justin Lampel

(57) **CLAIM**

The ornamental design for a case, as shown and described.

DESCRIPTION

FIG. 1 is a perspective view of a case showing the claimed design;

FIG. 2 is a top plan view thereof;

FIG. 3 is a left side view thereof;

FIG. 4 is a front elevational view thereof;

FIG. 5 is a right side view thereof;

FIG. 6 is a rear elevational view thereof; and,

FIG. 7 is a bottom plan view thereof.

1 Claim, 7 Drawing Sheets

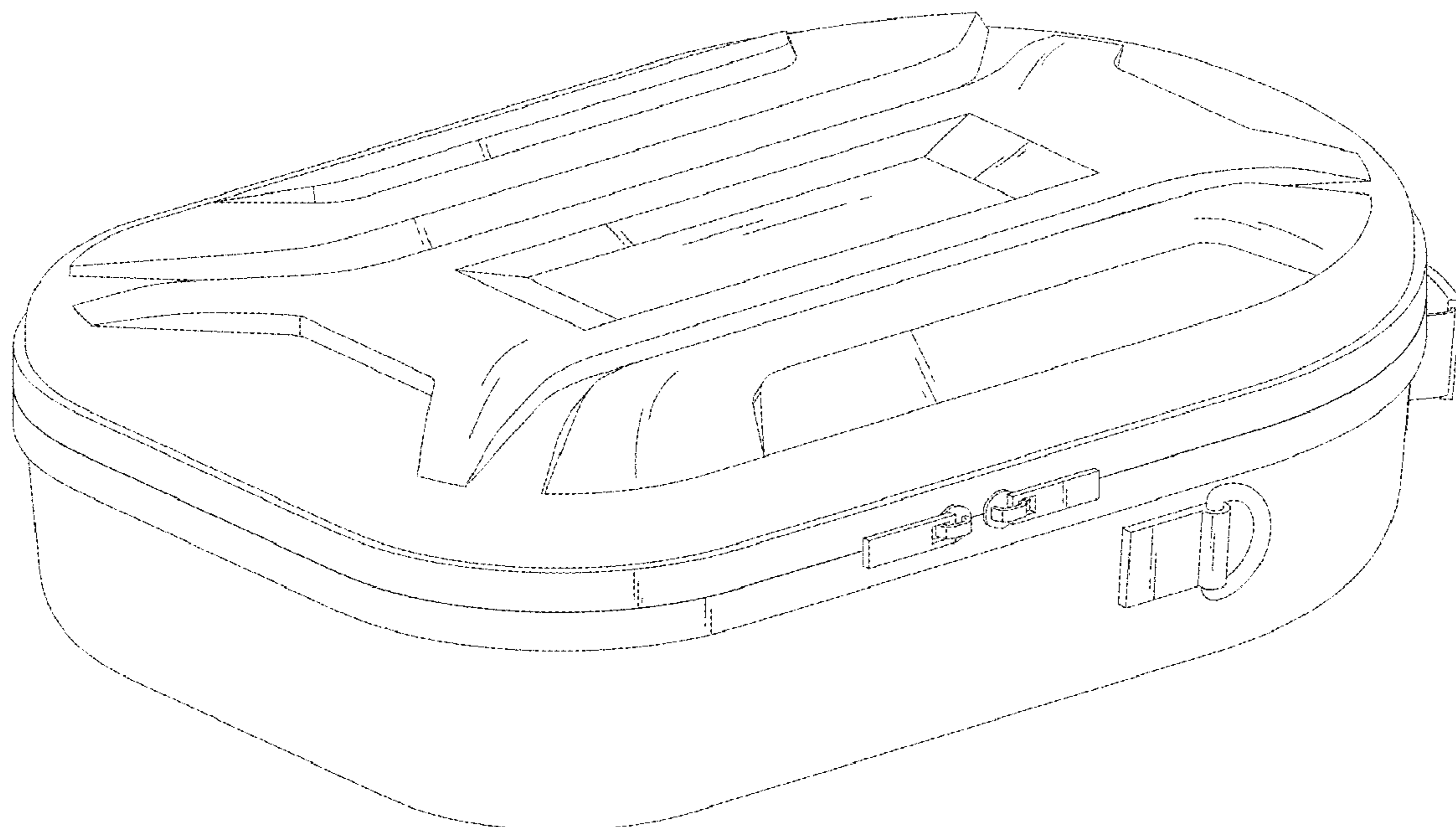

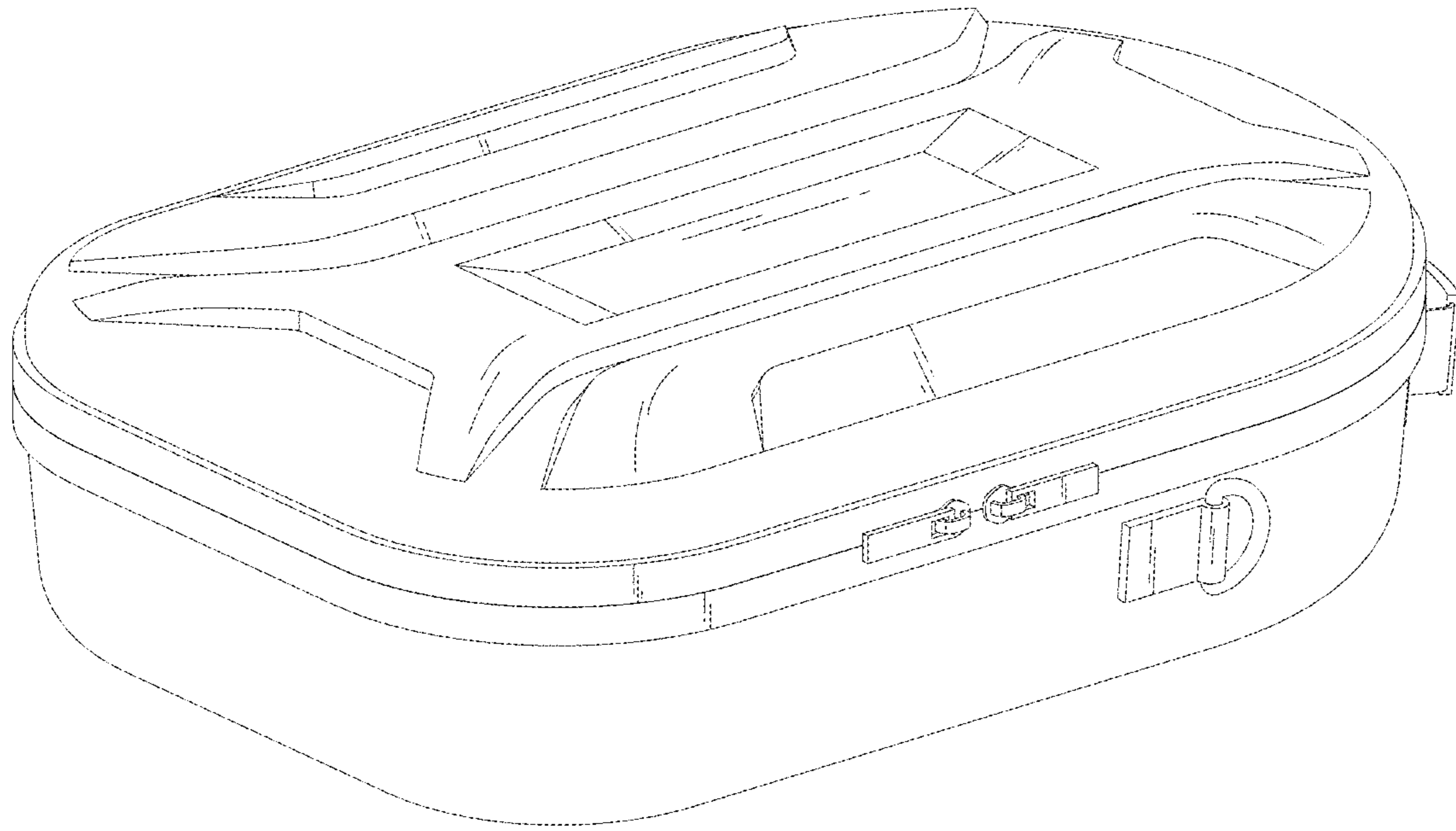

FIG.1

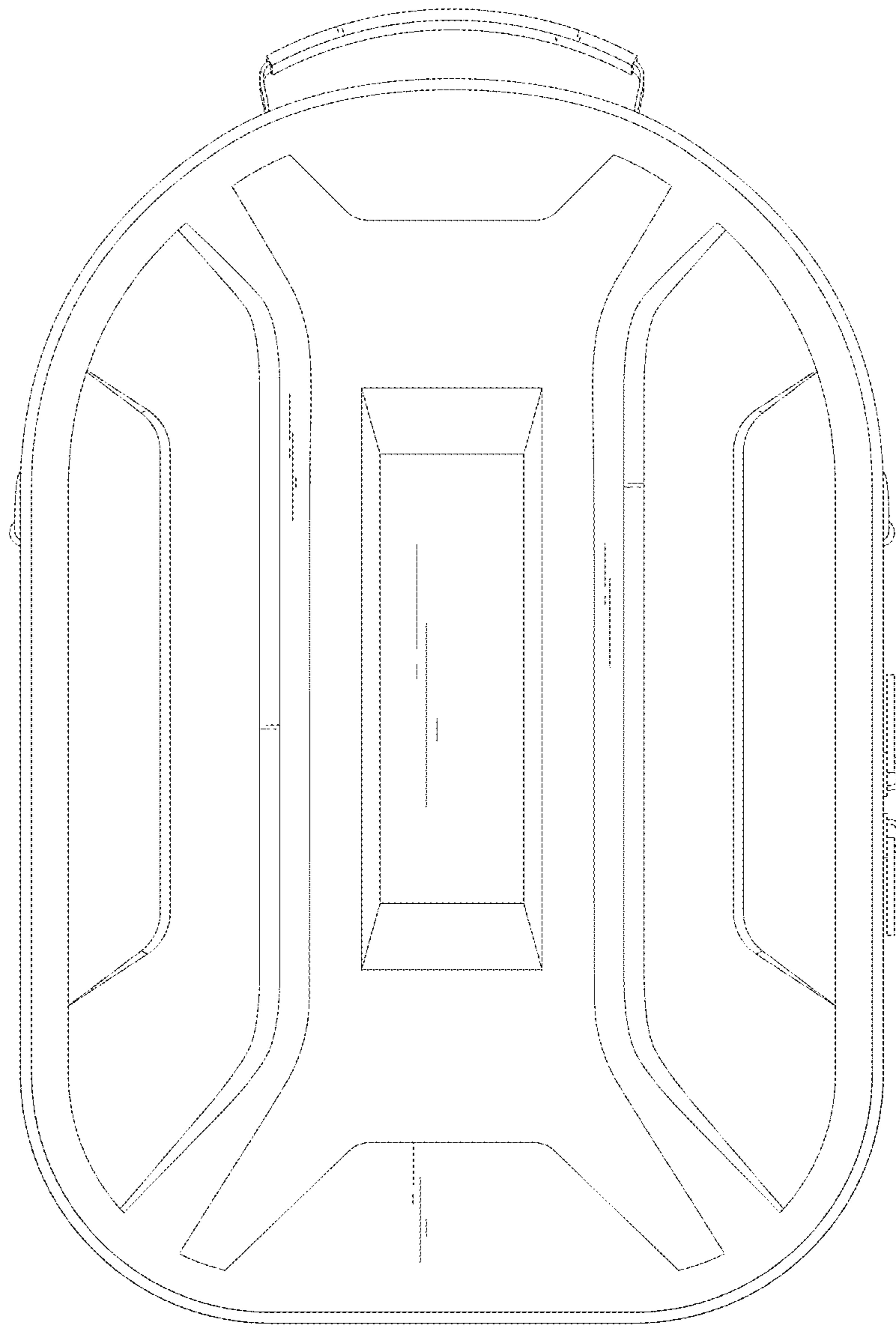

FIG.2

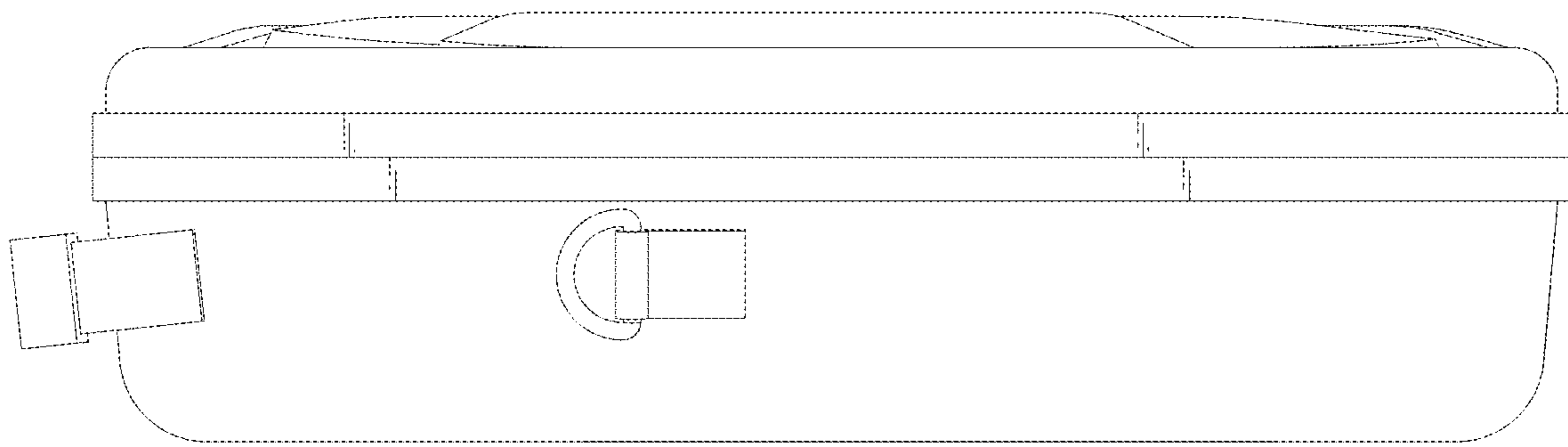

FIG.3

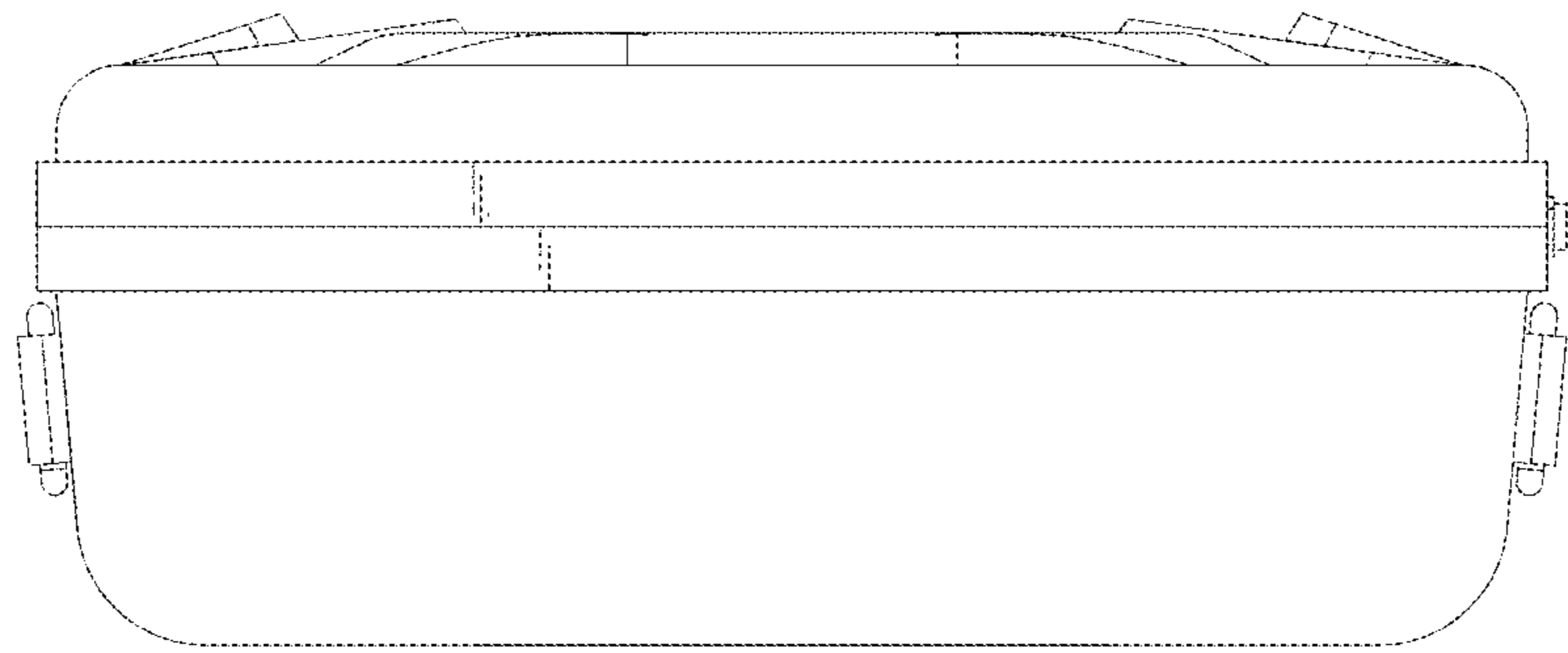

FIG. 4

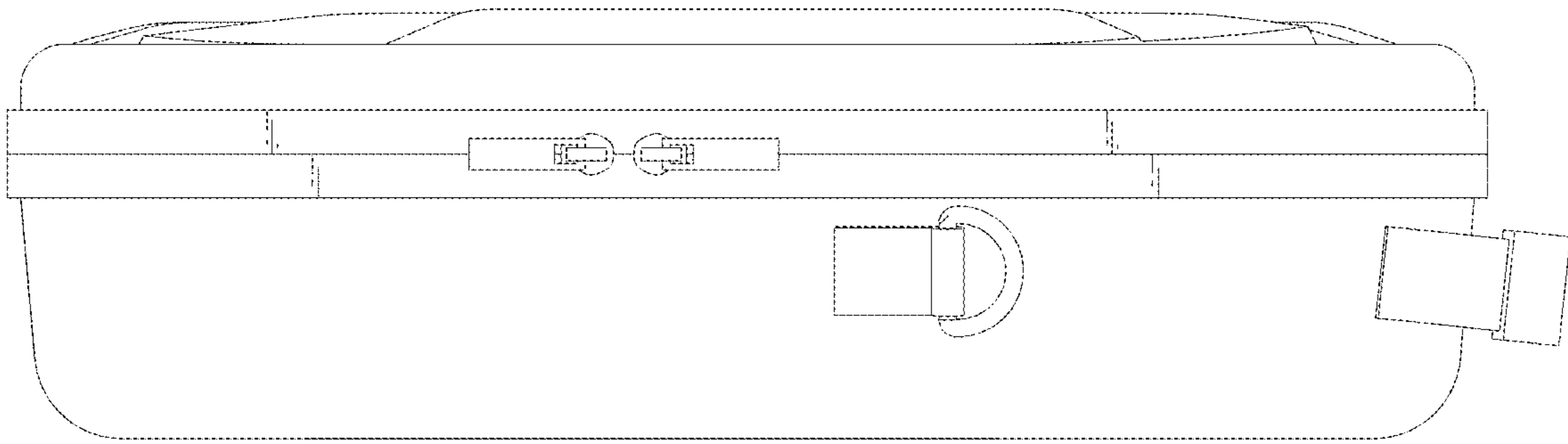

FIG.5

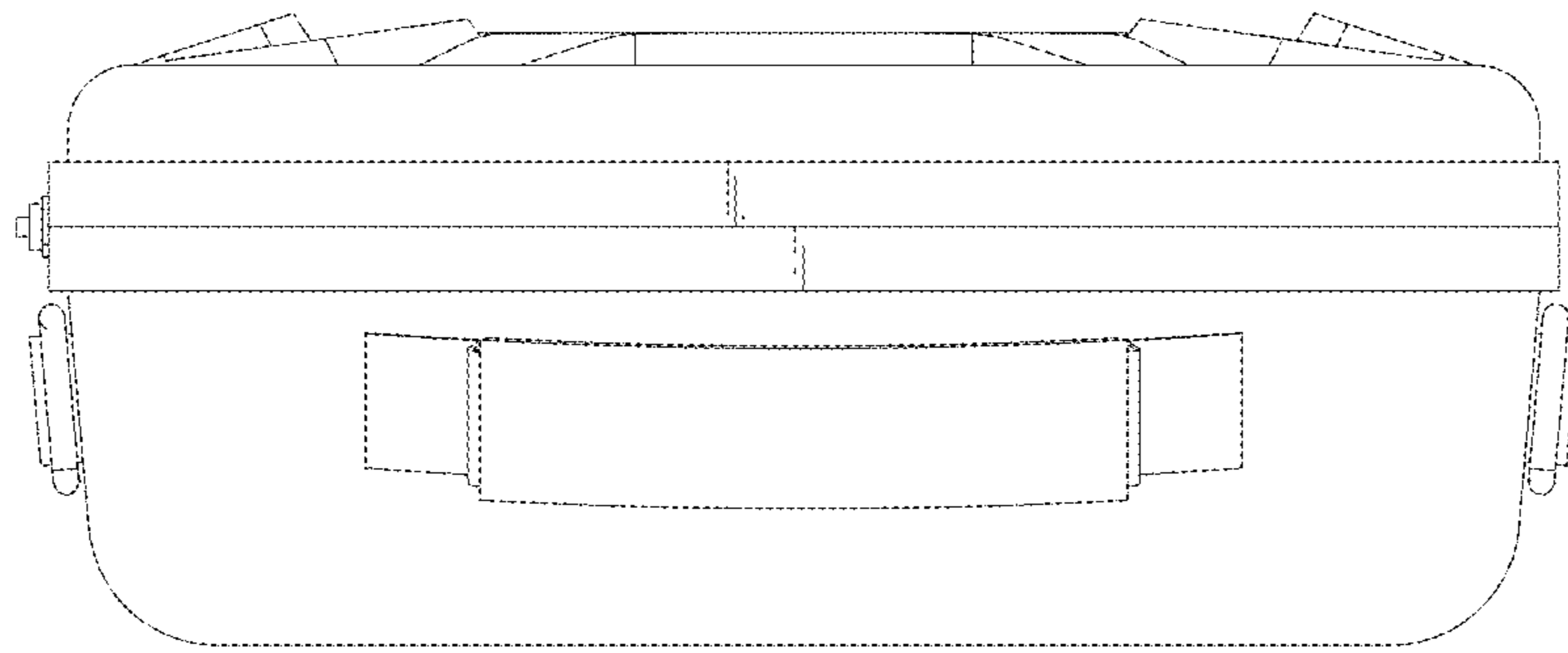

FIG.6

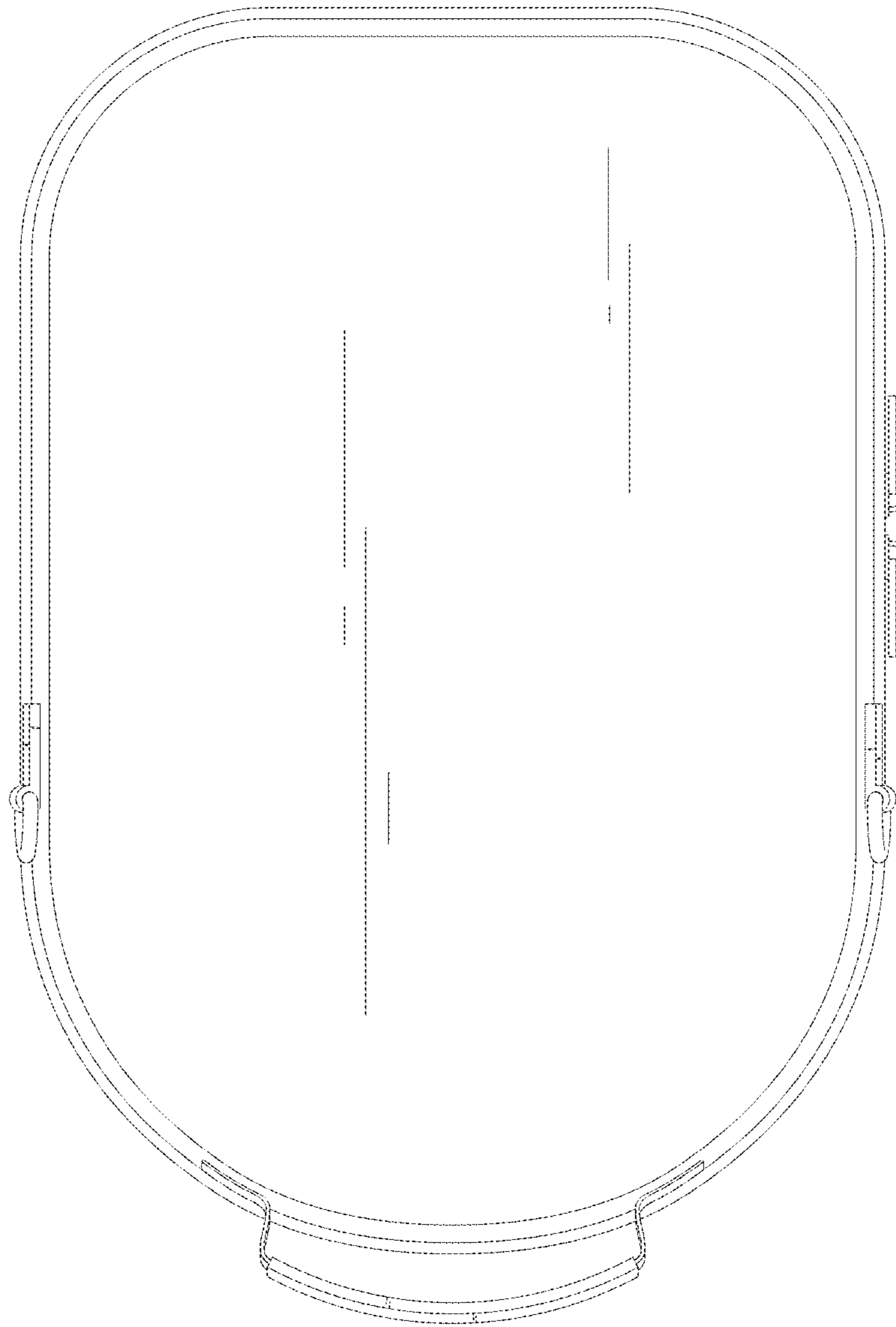

FIG. 7