



US00D963304S

(12) **United States Design Patent**
Aniemena

(10) **Patent No.:** **US D963,304 S**

(45) **Date of Patent:** **** Sep. 13, 2022**

(54) **SHOE STRAP**

(71) Applicant: **Chibuzo Aniemena**, Venice, CA (US)

(72) Inventor: **Chibuzo Aniemena**, Venice, CA (US)

(**) Term: **15 Years**

(21) Appl. No.: **29/788,008**

(22) Filed: **Feb. 8, 2021**

(51) **LOC (13) Cl.** **02-04**

(52) **U.S. Cl.**
USPC **D2/946**; D2/978

(58) **Field of Classification Search**
USPC D2/902, 907, 908, 969, 972-974, 977
CPC A43B 1/04; A43B 5/06; A43B 5/10
See application file for complete search history.

(56) **References Cited**

U.S. PATENT DOCUMENTS

D417,664 S *	12/1999	Goto	G05G 9/047
				D14/401
D441,369 S *	5/2001	Goto	D14/413
D596,383 S *	7/2009	Morris	D2/907
D659,378 S *	5/2012	Loverin	D2/900
8,956,228 B2	2/2015	Shum et al.		
D771,932 S *	11/2016	Little	D2/978
D815,814 S *	4/2018	Scott	D2/978
D845,610 S *	4/2019	Mayden	D2/978
D848,122 S *	5/2019	Mayden	D2/907
D850,779 S *	6/2019	Sokol	D2/973

D870,441 S	12/2019	Wilkinson		
D887,118 S	6/2020	Enayah		
D903,286 S	12/2020	Cruz		
D904,746 S	12/2020	Webb		
2001/0018363 A1 *	8/2001	Goto	G05G 9/047
				463/37
2005/0227811 A1	10/2005	Shum et al.		

* cited by examiner

Primary Examiner — Kevin K Rudzinski
Assistant Examiner — Clare Ann Gannon
(74) *Attorney, Agent, or Firm* — Dunlap Bennett & Ludwig, PLLC; Anna L. Kinney

(57) **CLAIM**

The ornamental design for a shoe strap, as shown and described.

DESCRIPTION

FIG. 1 is a top perspective view of a shoe strap showing my new design;
FIG. 2 is a bottom perspective view thereof;
FIG. 3 is a top plan view thereof;
FIG. 4 is a bottom plan view thereof;
FIG. 5 is a left side elevation view thereof, the right side being a mirror image thereof;
FIG. 6 is front elevation view thereof;
FIG. 7 is rear elevation view thereof; and,
FIG. 8 is a perspective view thereof, shown in use.
The broken lines shown in the drawings depict environmental structure that forms no part of the claimed invention.

1 Claim, 4 Drawing Sheets

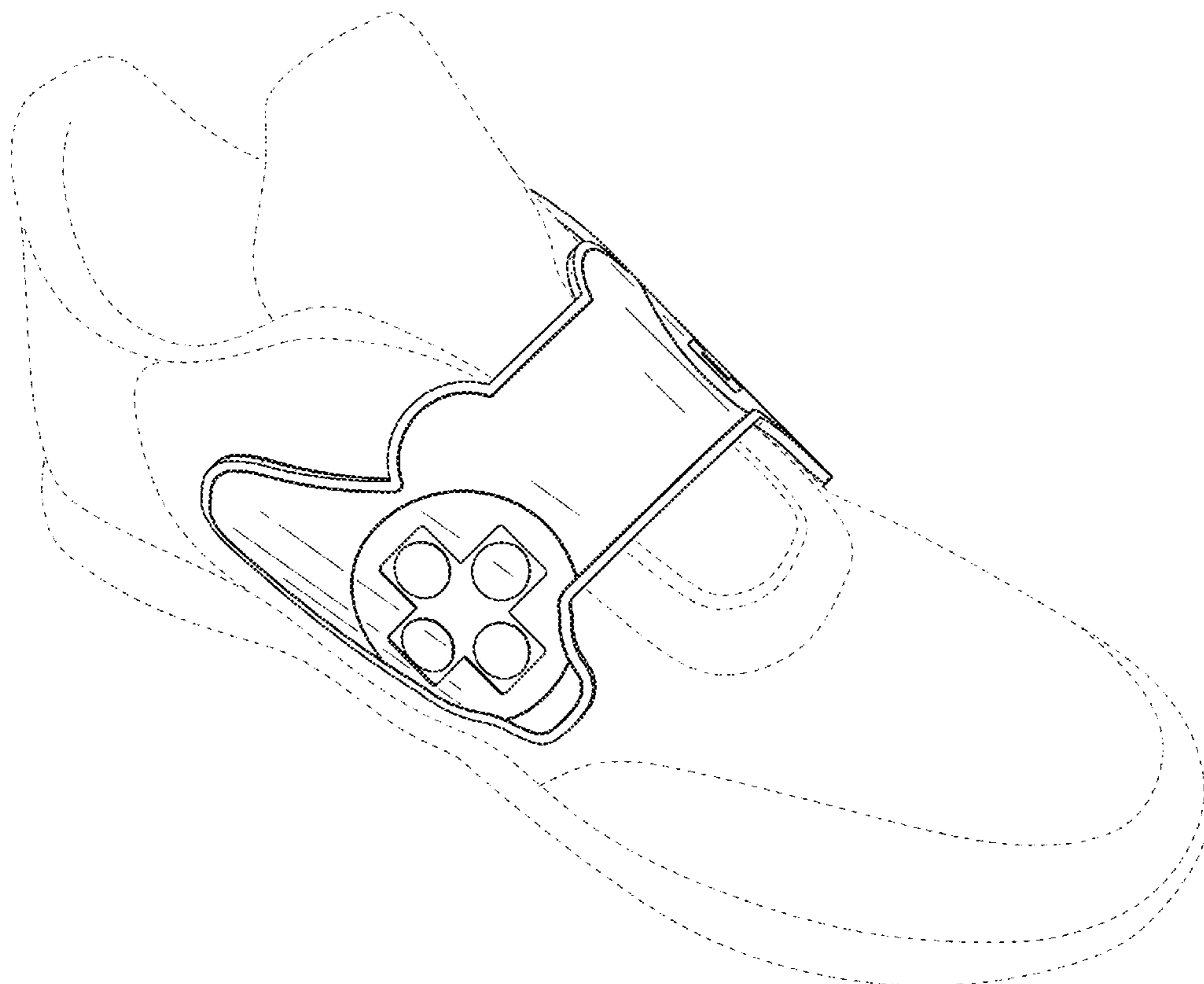

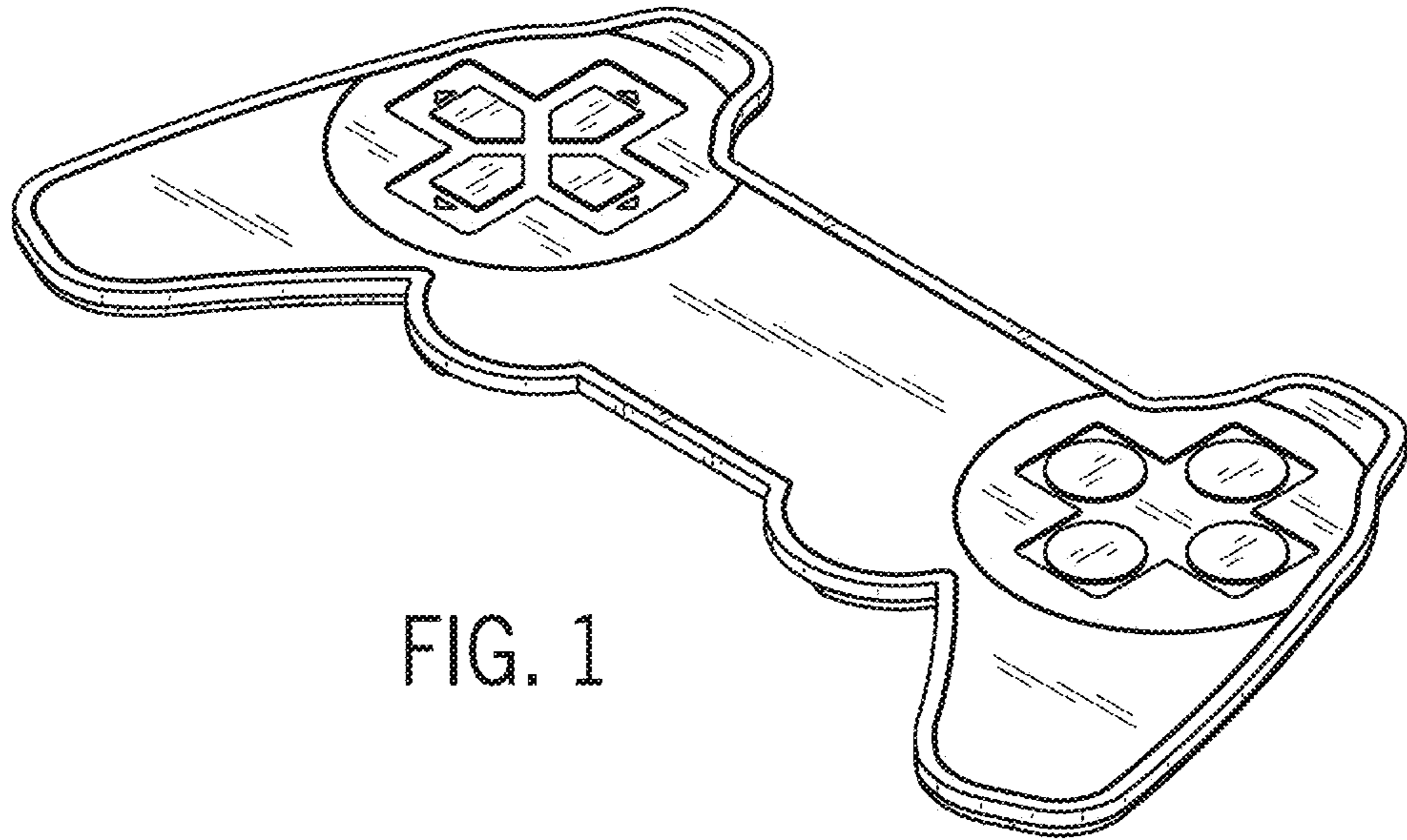

FIG. 1

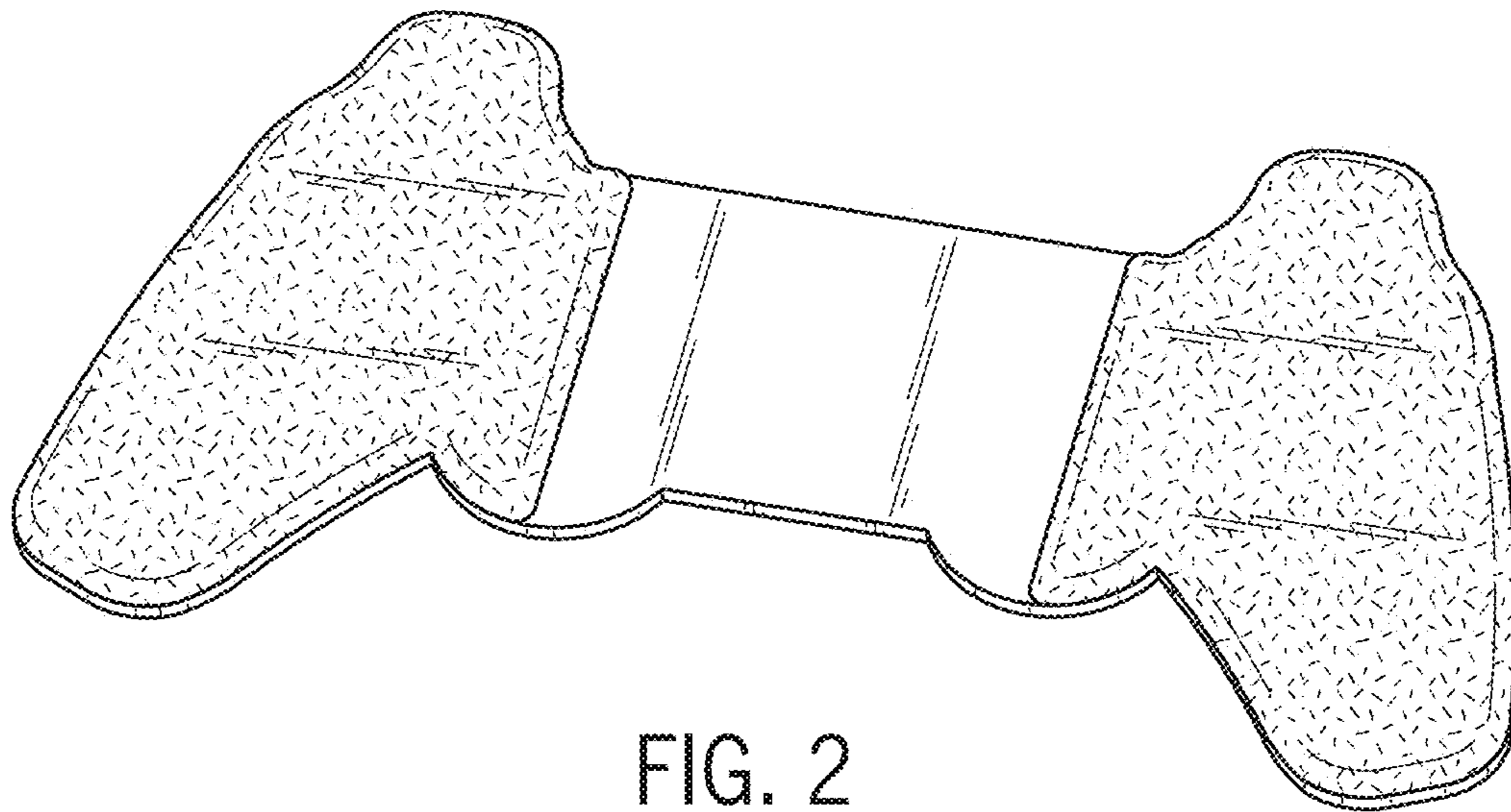

FIG. 2

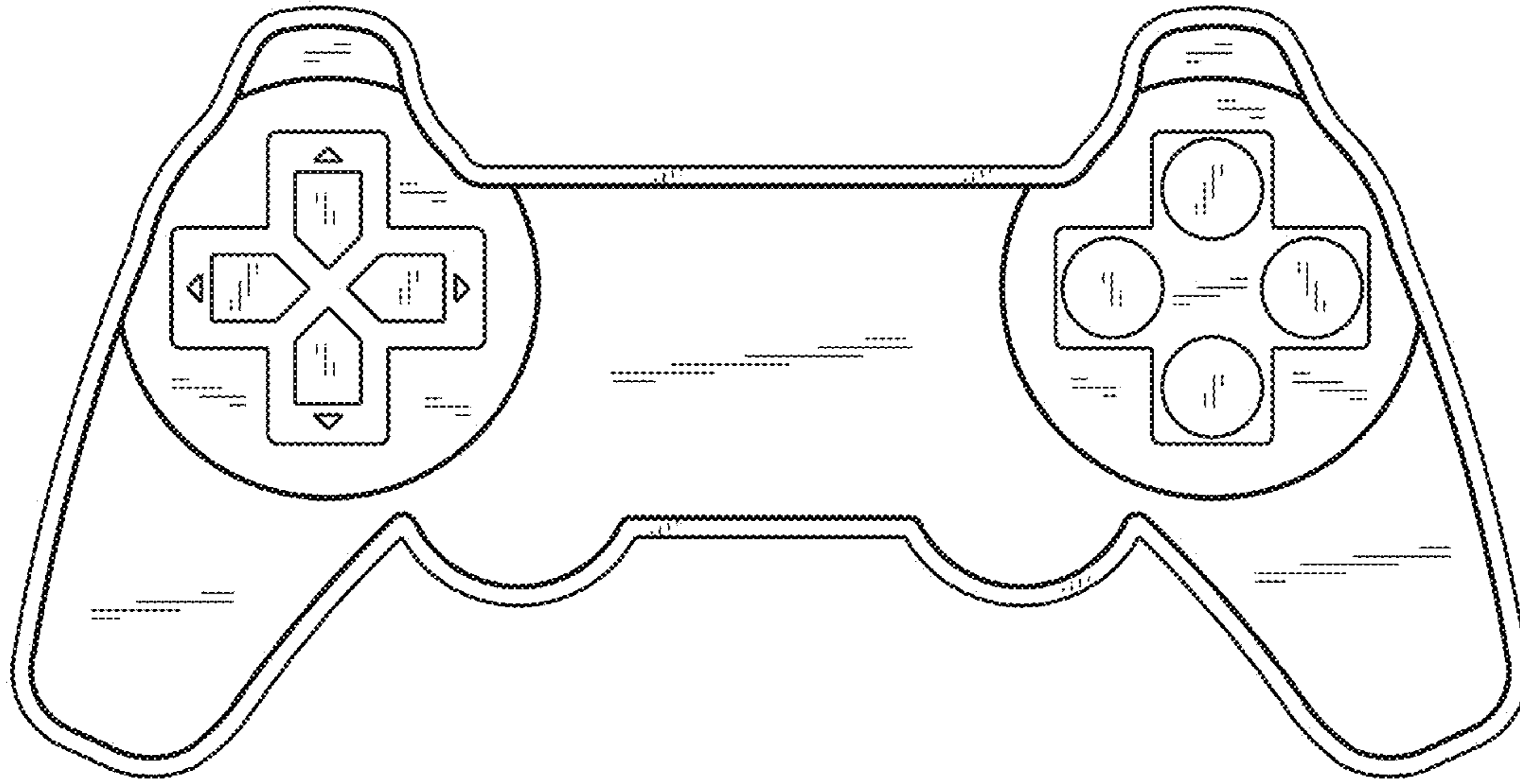

FIG. 3

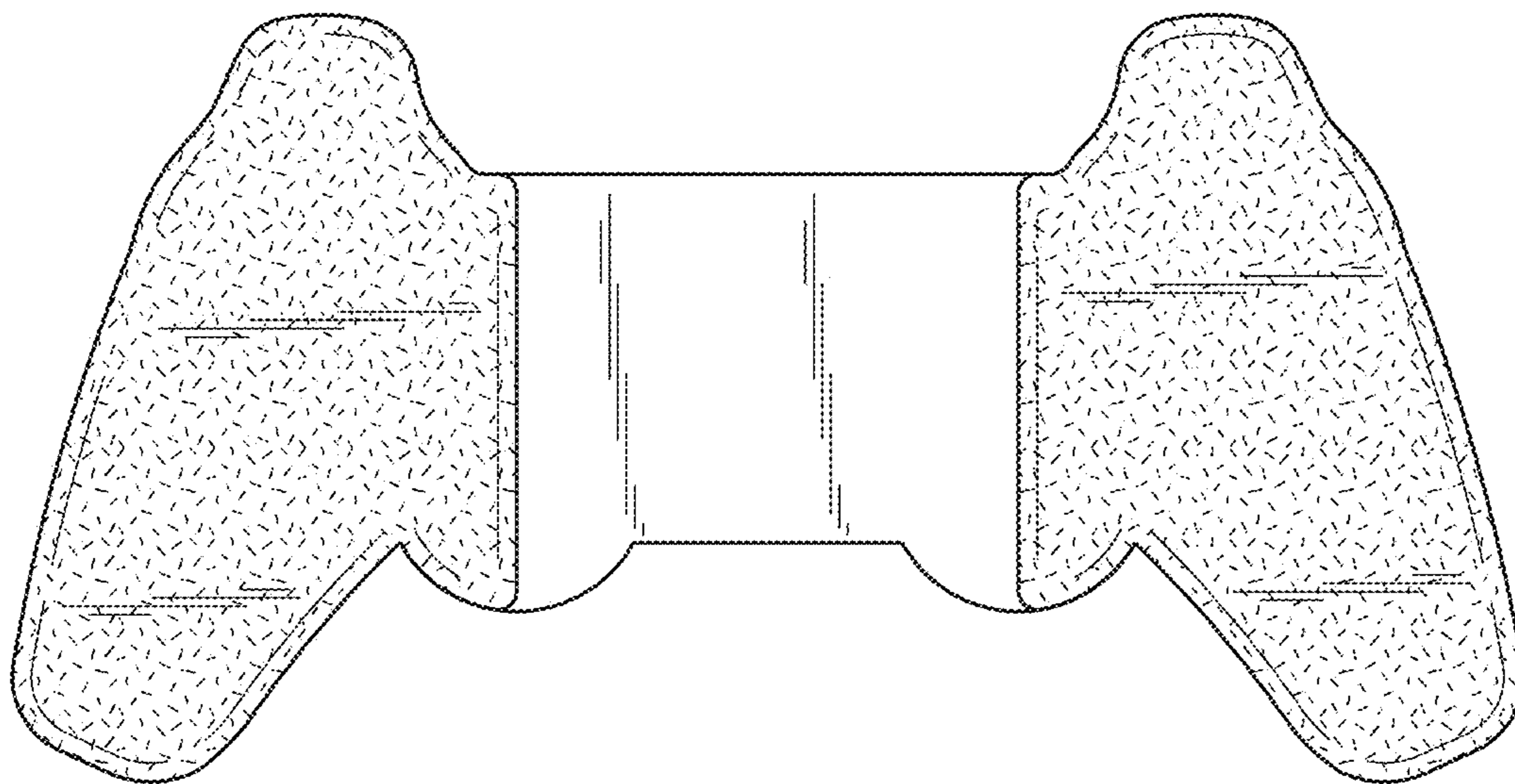

FIG. 4

FIG. 5

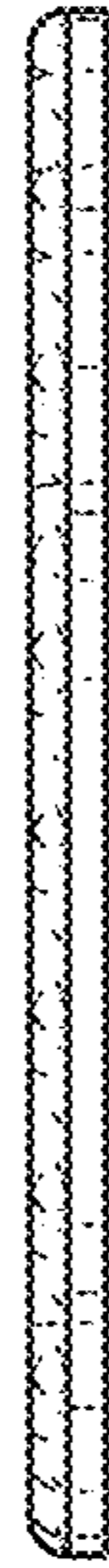

FIG. 6

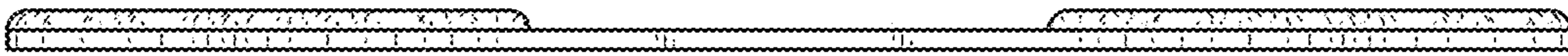
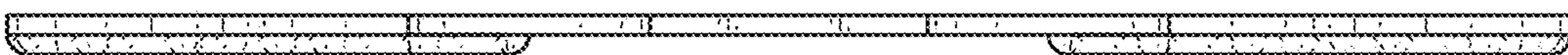

FIG. 7



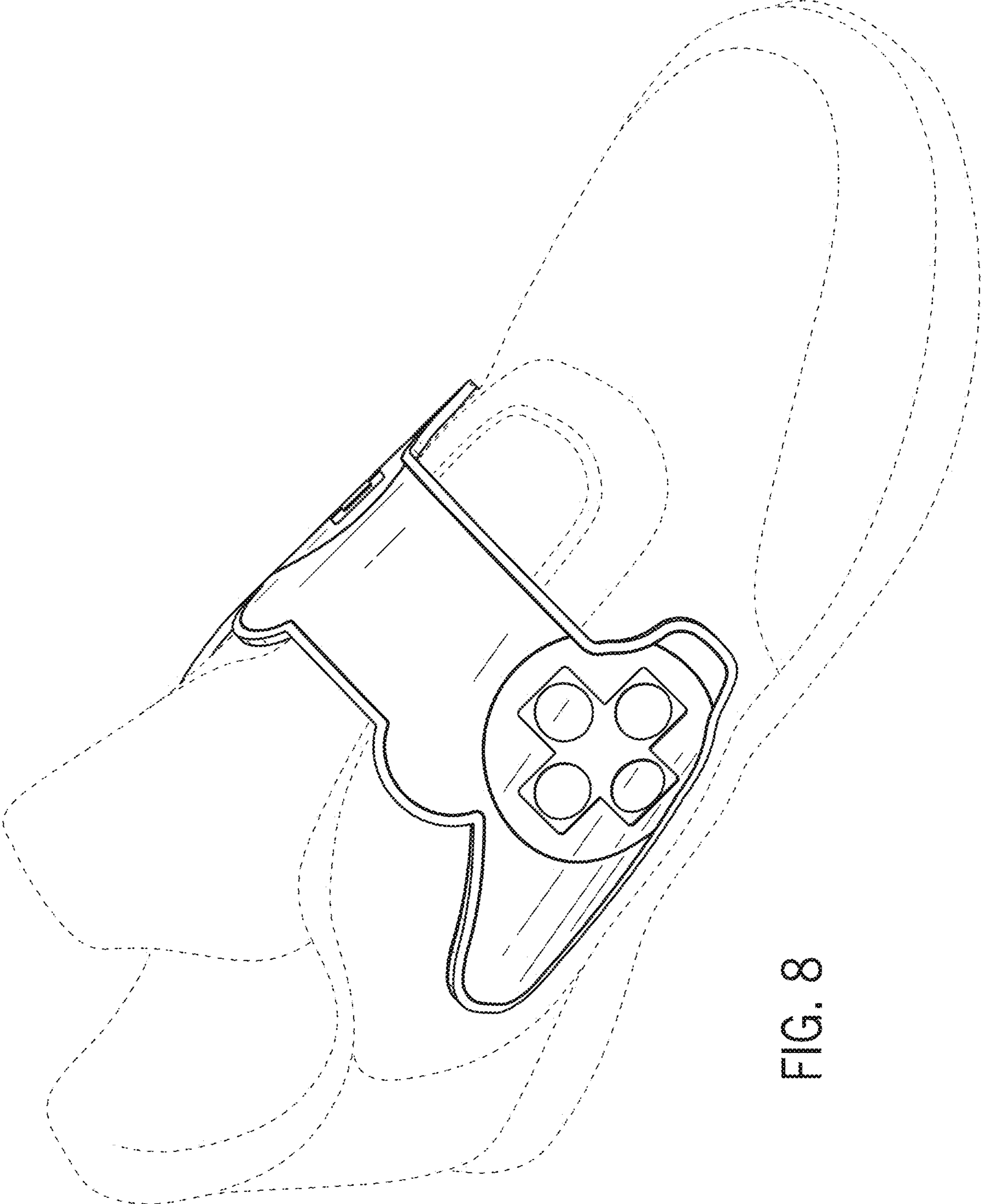

FIG. 8