



US00D963302S

(12) **United States Design Patent** (10) **Patent No.:** **US D963,302 S**  
**Livne** (45) **Date of Patent:** **\*\* Sep. 13, 2022**

(54) **SHOE**

(71) Applicant: **APOS MEDICAL ASSETS LTD.**, Tel Aviv (IL)

(72) Inventor: **Oren Livne**, Tel Aviv (IL)

(73) Assignee: **APOS MEDICAL ASSETS LTD.**, Tel Aviv (IL)

(\*\*) Term: **15 Years**

(21) Appl. No.: **29/743,198**

(22) Filed: **Jul. 20, 2020**

(51) **LOC (13) Cl.** ..... **02-04**

(52) **U.S. Cl.**  
USPC ..... **D2/896**; D2/897; D2/906

(58) **Field of Classification Search**  
USPC ..... D2/902, 946-962, 896, 900, 904, D2/906-908, 916-924, 925-945, 969, D2/970-979; 36/1, 1.5, 3 B, 22 R, 24.5, 36/25 R, 28, 32 R, 34 R, 59 C, 67 A, 36/101-107, 114-116, 117.3, 117.4, 36/124-136, 3 A, 83, 45, 99, 112-116  
CPC ..... A43B 13/00; A43B 13/02; A43B 13/023; A43B 13/026; A43B 13/04; A43B 13/08; A43B 13/10; A43B 13/12; A43B 13/14; A43B 13/141; A43B 13/143; A43B 13/16; A43B 13/18; A43B 13/181; A43B 13/187; A43B 13/189; A43B 13/20; A43B 13/22; A43B 13/223; A43B 13/24; A43B 13/28; A43B 13/30; A43B 13/32; A43B 13/34; A43B 13/36; A43B 23/00; A43B 23/02; A43B 23/04; A43B 23/07; A43B 23/024; A43B 23/0245; A43B 23/025; A43B 23/026; A43B 23/265; A43B 23/14; A43B 23/16; A43B 23/24; A43B 23/26; A43B 5/00; A43B 5/001; A43B 5/002; A43B 5/003; A43B 5/008; A43B 5/06; A43B 5/08; A43B 5/10; A43B 5/12; A43B 5/14; A43B 5/145; A43B 1/00; A43B 1/02; A43B

(Continued)

(56) **References Cited**

U.S. PATENT DOCUMENTS

D267,366 S \* 12/1982 Davis ..... D2/951  
4,446,634 A \* 5/1984 Johnson ..... A43B 13/206  
36/28

(Continued)

OTHER PUBLICATIONS

Women Faux Suede Mesh Bubble Sole Lace Up Sneaker 18794, Walmart.com, [online], [site visited Sep. 29, 2021]. <URL: https://www.walmart.com/ip/Women-Faux-Suede-Mesh-Bubble-Sole-Lace-Up-Sneaker-18794/469094546> (Year: 2021).\*

(Continued)

*Primary Examiner* — Jonathan J Han

(74) *Attorney, Agent, or Firm* — The Roy Gross Law Firm, LLC; Roy Gross

(57) **CLAIM**

The ornamental design for a shoe, as shown and described.

**DESCRIPTION**

FIG. 1 is a left view of a shoe in accordance with the new design;  
FIG. 2 is a right view thereof;  
FIG. 3 is a rear view thereof;  
FIG. 4 is a front view thereof;  
FIG. 5 is a top view thereof;  
FIG. 6 is a bottom view thereof of a shoe with half-dome portions removed, showing recessed slots;  
FIG. 7 is a bottom view thereof of a shoe in accordance with the new design;  
FIG. 8 is an isometric view thereof; and,  
FIG. 9 is an exploded isometric view thereof.  
The broken lines in the figures show portions of the shoe that form no part of the claimed design.

**1 Claim, 9 Drawing Sheets**

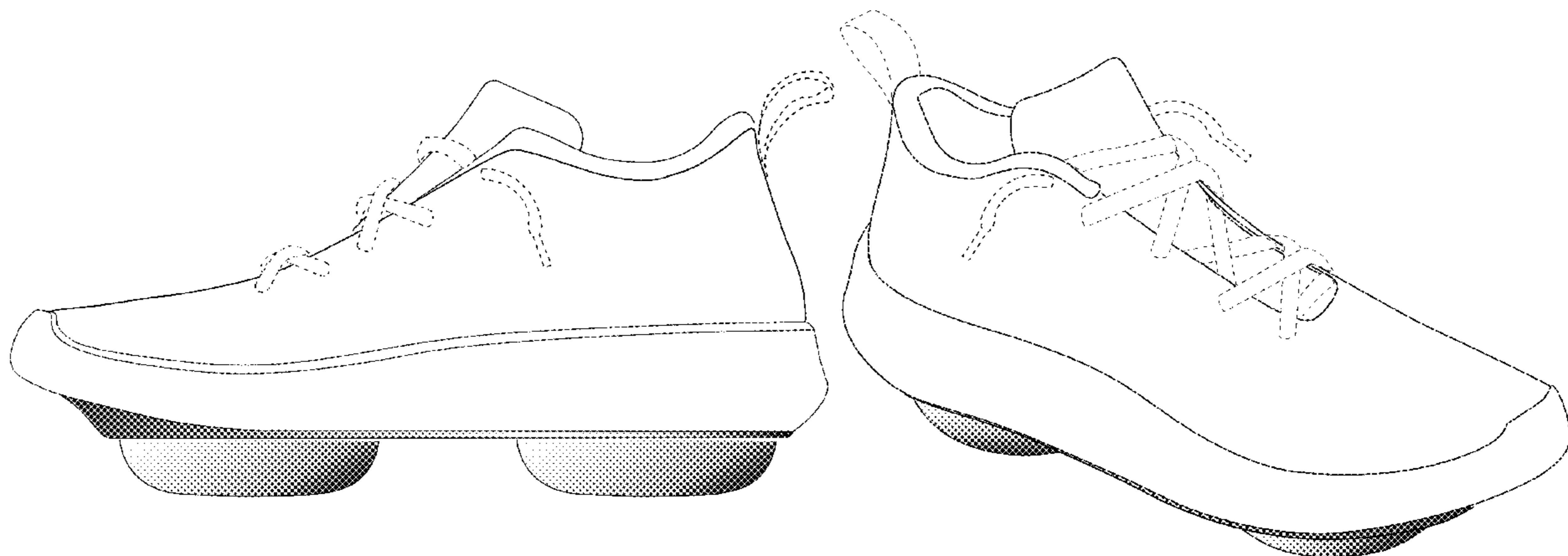

(58) **Field of Classification Search**

CPC . 1/04; A43B 1/0045; A43B 3/12; A43B 7/00;  
 A43B 9/00; A43B 9/08; A43B 9/14;  
 A43B 9/16; A43B 11/00; A43B 21/00;  
 A43B 21/02; A43B 21/04; A43B 21/06;  
 A43C 1/00; A43C 1/003; A43C 1/06;  
 A43C 3/00; A43C 5/00; A43C 7/00;  
 A43C 11/00

See application file for complete search history.

(56) **References Cited**

U.S. PATENT DOCUMENTS

D395,157 S \* 6/1998 von Conta ..... D2/955  
 D488,915 S \* 4/2004 Girbaud ..... A43B 13/145  
 D2/951  
 6,979,287 B2 12/2005 Elbaz et al.  
 7,101,330 B2 9/2006 Elbaz et al.  
 7,462,158 B2 12/2008 Mor  
 D597,287 S \* 8/2009 Vestuti ..... D2/951  
 D643,197 S \* 8/2011 Teteriatnikov ..... D2/960  
 D643,607 S \* 8/2011 Teteriatnikov ..... D2/954  
 D644,008 S \* 8/2011 Teteriatnikov ..... D2/954  
 D644,009 S \* 8/2011 Akhidime ..... D2/956  
 D648,517 S \* 11/2011 Vestuti ..... D2/955  
 D659,363 S \* 5/2012 Leary ..... D2/955  
 D677,040 S \* 3/2013 Vestuti ..... D2/947  
 D677,866 S \* 3/2013 Vestuti ..... D2/947  
 8,397,404 B2 \* 3/2013 Kim ..... A43B 13/145  
 36/103  
 8,533,980 B2 9/2013 Elbaz et al.  
 D697,293 S \* 1/2014 Vestuti ..... D2/947  
 D697,704 S \* 1/2014 Vestuti ..... D2/955  
 8,758,207 B2 6/2014 Elbaz et al.  
 D719,331 S \* 12/2014 Christensen ..... D2/955  
 9,055,788 B2 6/2015 Elbaz et al.  
 D747,596 S \* 1/2016 Vestuti ..... D2/955  
 9,271,895 B2 3/2016 Mor et al.  
 9,357,812 B2 6/2016 Elbaz et al.  
 D762,365 S \* 8/2016 Vestuti ..... D2/947

9,445,965 B2 9/2016 Mor et al.  
 9,462,846 B2 \* 10/2016 Litchfield ..... A43B 13/189  
 D779,179 S \* 2/2017 Christensen ..... D2/955  
 D785,302 S \* 5/2017 Karnazes ..... D2/951  
 9,693,927 B2 7/2017 Mor et al.  
 9,788,597 B2 10/2017 Elbaz et al.  
 D807,623 S \* 1/2018 Vestuti ..... D2/954  
 9,861,509 B2 1/2018 Elbaz et al.  
 10,010,743 B2 7/2018 Elbaz et al.  
 D839,563 S \* 2/2019 Karnazes ..... D2/947  
 D854,298 S \* 7/2019 Nethongkome ..... D2/955  
 10,632,006 B2 4/2020 Elbaz et al.  
 10,744,368 B2 8/2020 Elbaz et al.  
 10,750,812 B2 8/2020 Mor et al.  
 10,758,004 B2 \* 9/2020 Case ..... B32B 7/05  
 2010/0251565 A1 \* 10/2010 Litchfield ..... A43B 13/181  
 36/28  
 2010/0251567 A1 \* 10/2010 McInnis ..... A43B 13/203  
 36/29  
 2011/0072684 A1 \* 3/2011 Stubblefield ..... A43B 13/122  
 36/29  
 2011/0126422 A1 \* 6/2011 Vattes ..... A43B 13/145  
 36/10  
 2017/0273400 A1 \* 9/2017 Penka ..... A43B 13/187  
 2018/0338577 A1 \* 11/2018 Elder ..... B32B 27/08  
 2020/0375302 A1 12/2020 Mor et al.  
 2020/0376323 A1 12/2020 Elbaz et al.

OTHER PUBLICATIONS

Missguided Cream Bubble Sole Sneakers, Poshmark.com, [online],  
 [site visited Sep. 29, 2021]. <URL: <https://poshmark.com/listing/missguided-cream-bubble-sole-sneakers-607711fee107bb01fb59dde6>> (Year: 2021).  
 Chung Shi Unisex's Comfort Step Sandale, Amazon.com, Date  
 First Available: Sep. 4, 2018, [online], [site visited Sep. 29, 2021].  
 <URL: <https://www.amazon.com/chung-shi-Unisexs-Comfort-Sandale/dp/B096LZZJ8J>> (Year: 2018).  
 Oren Livne et al, U.S. Appl. No. 17/312,603, filed Jun. 10, 2021.

\* cited by examiner

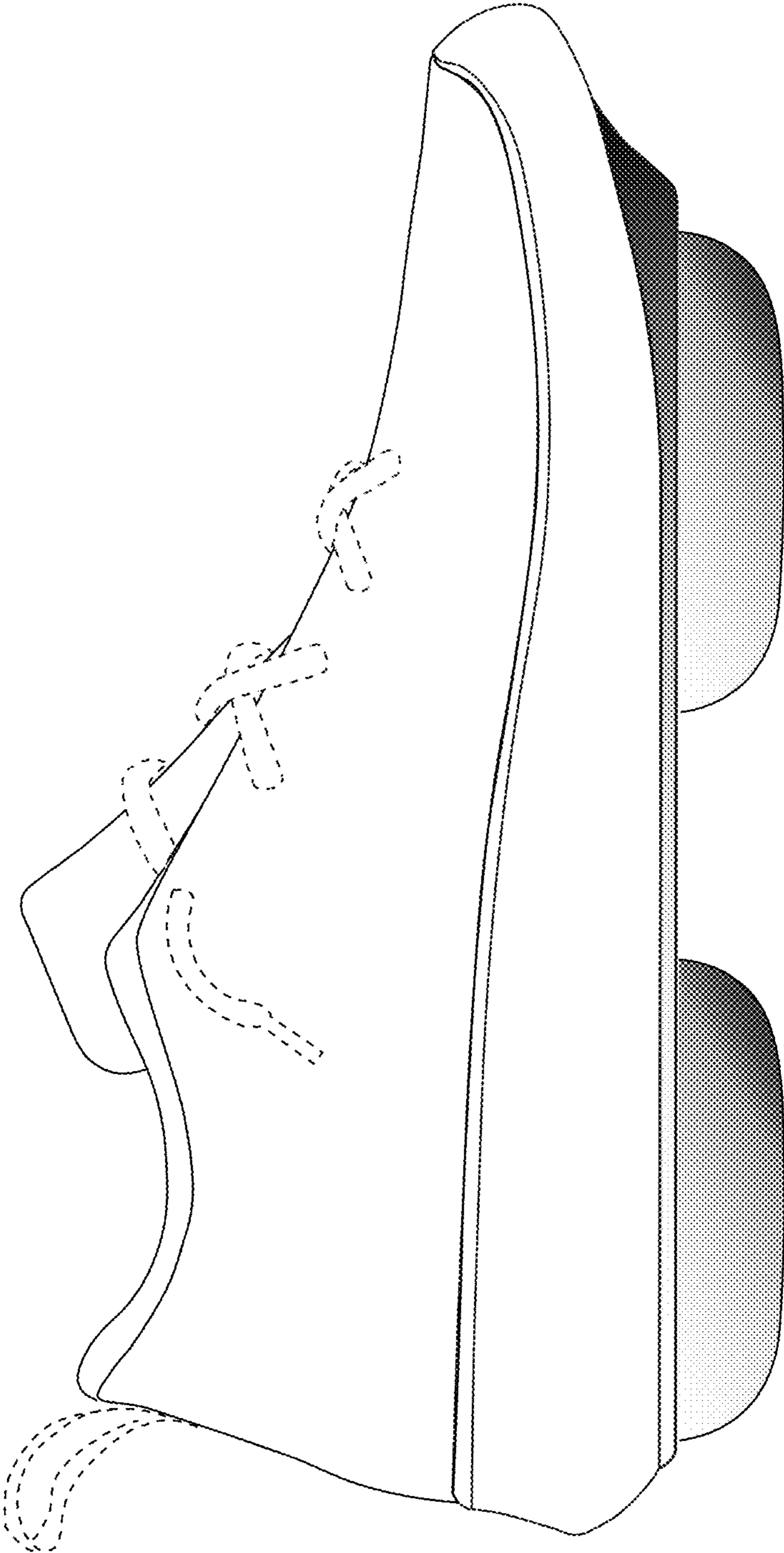

FIG.1

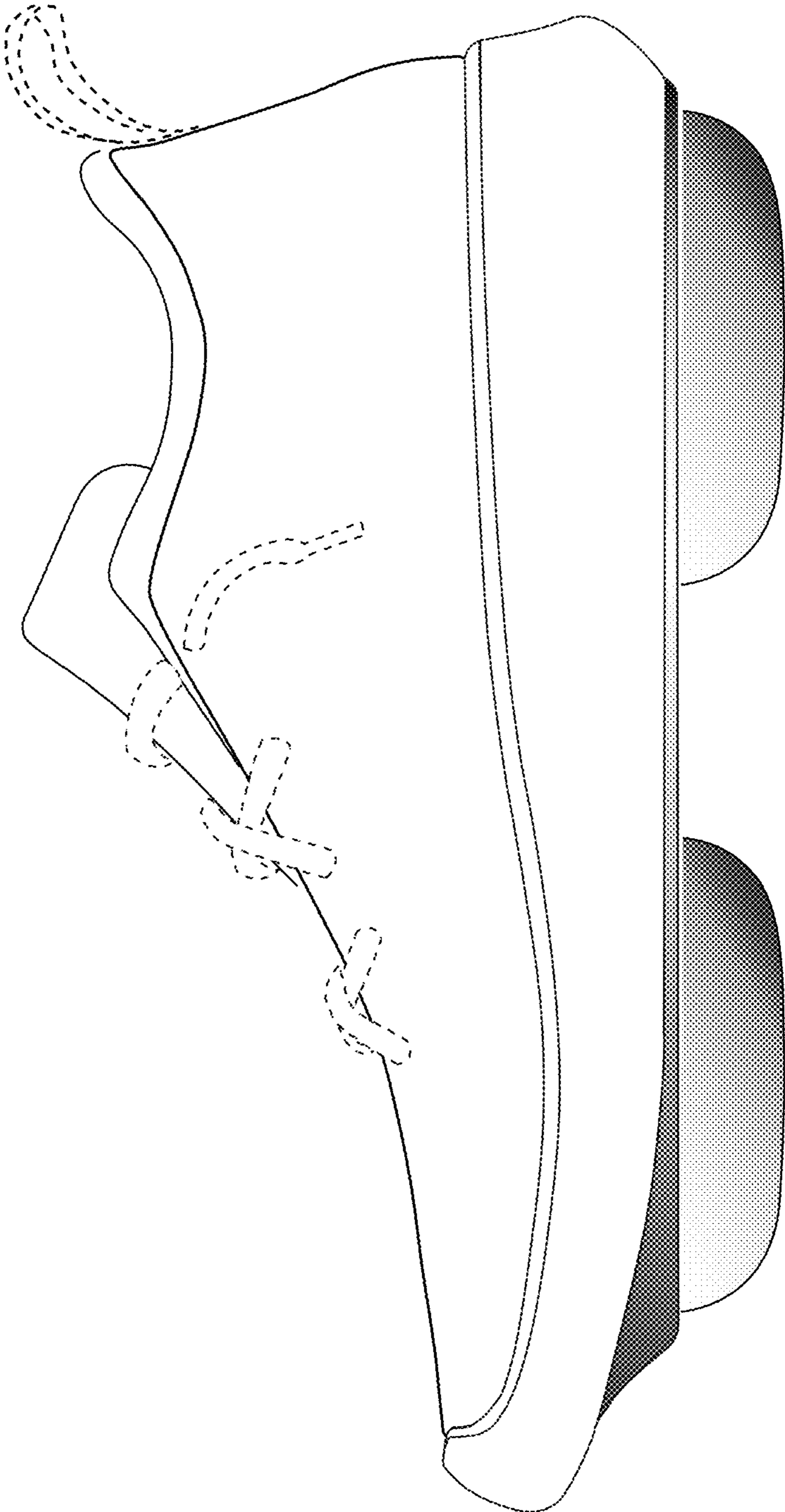

FIG. 2

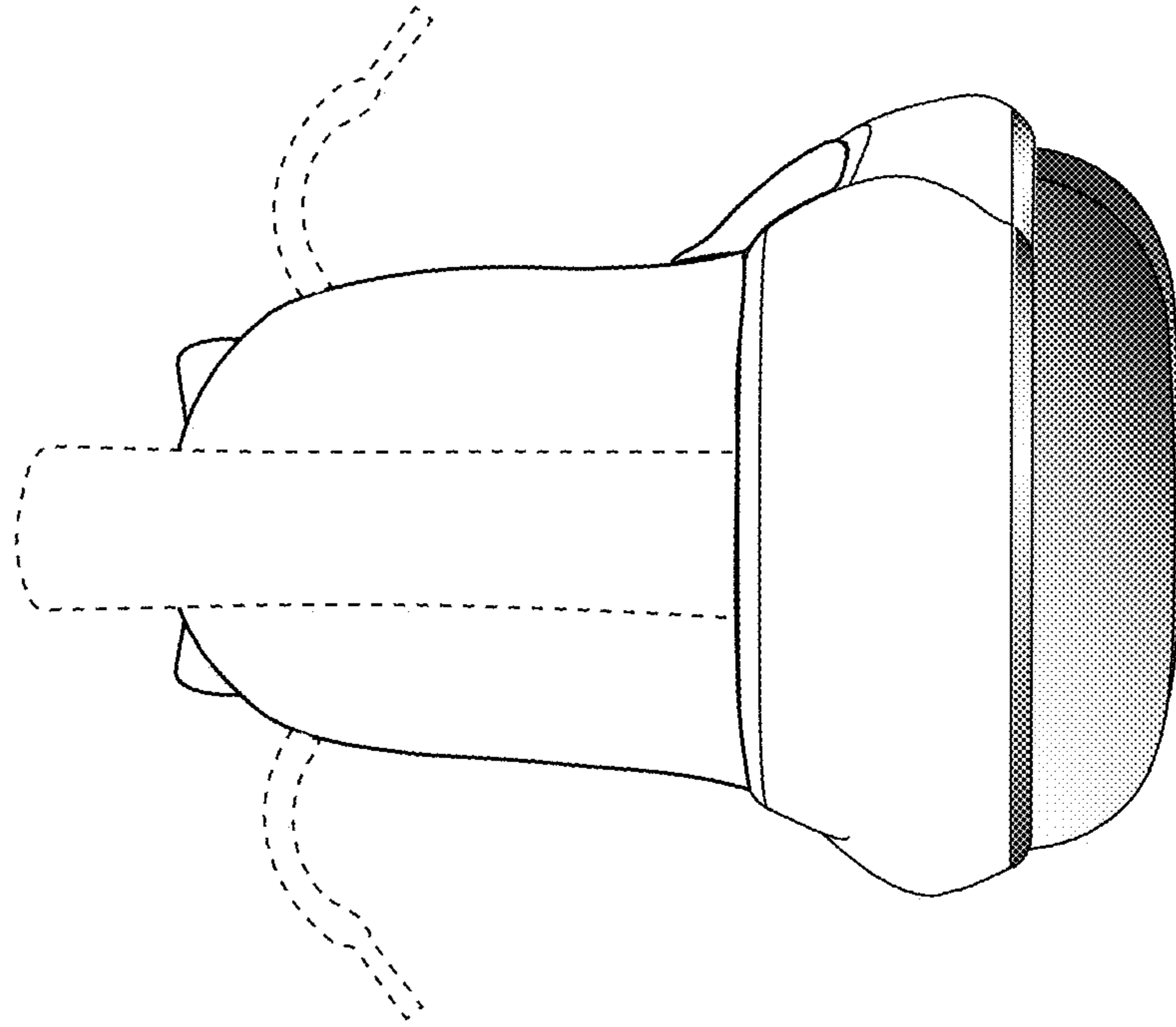

FIG. 3

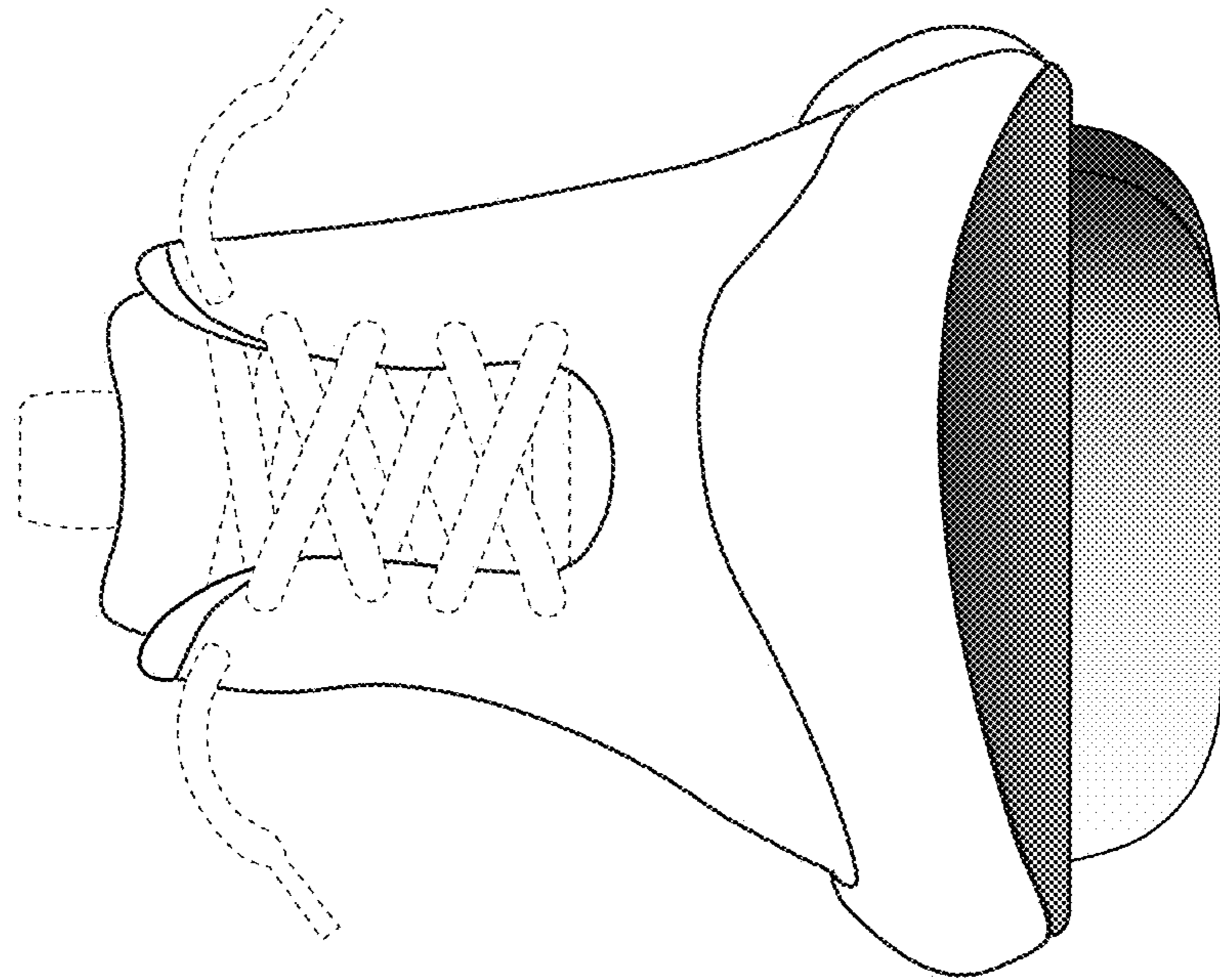

FIG. 4

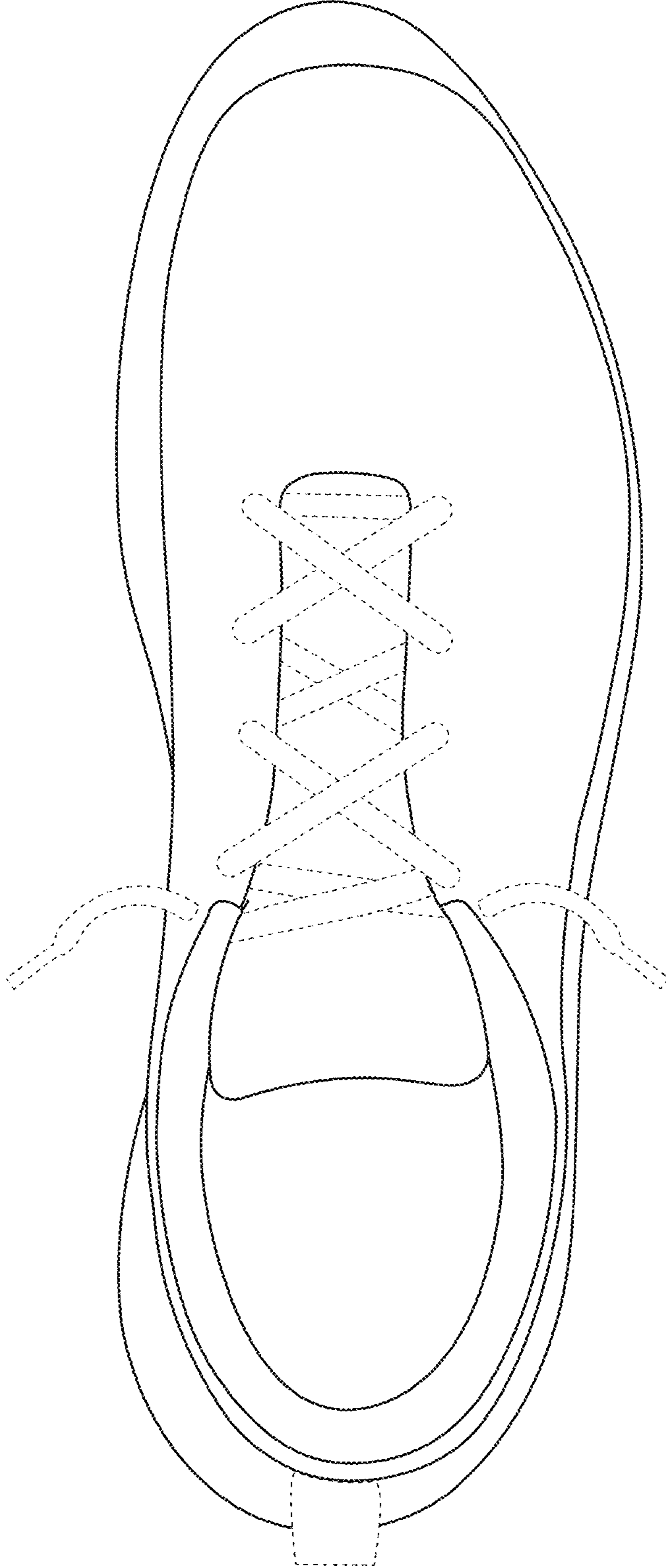

FIG. 5

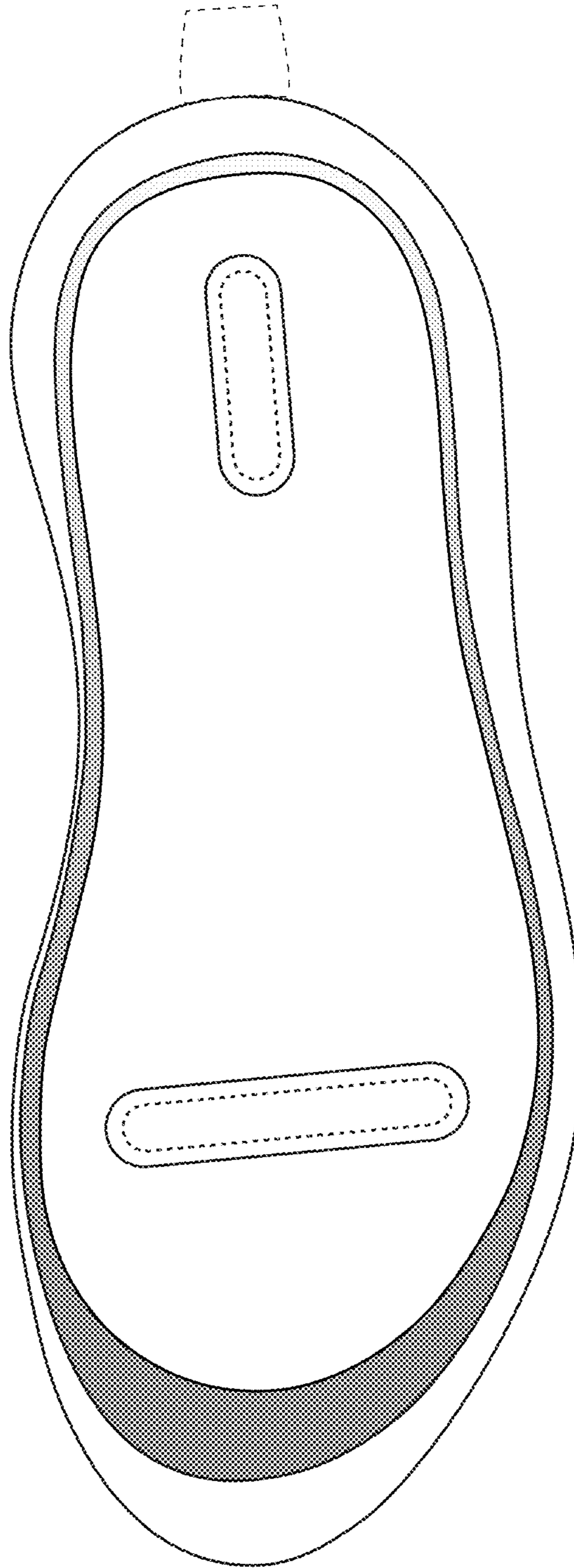

FIG. 6



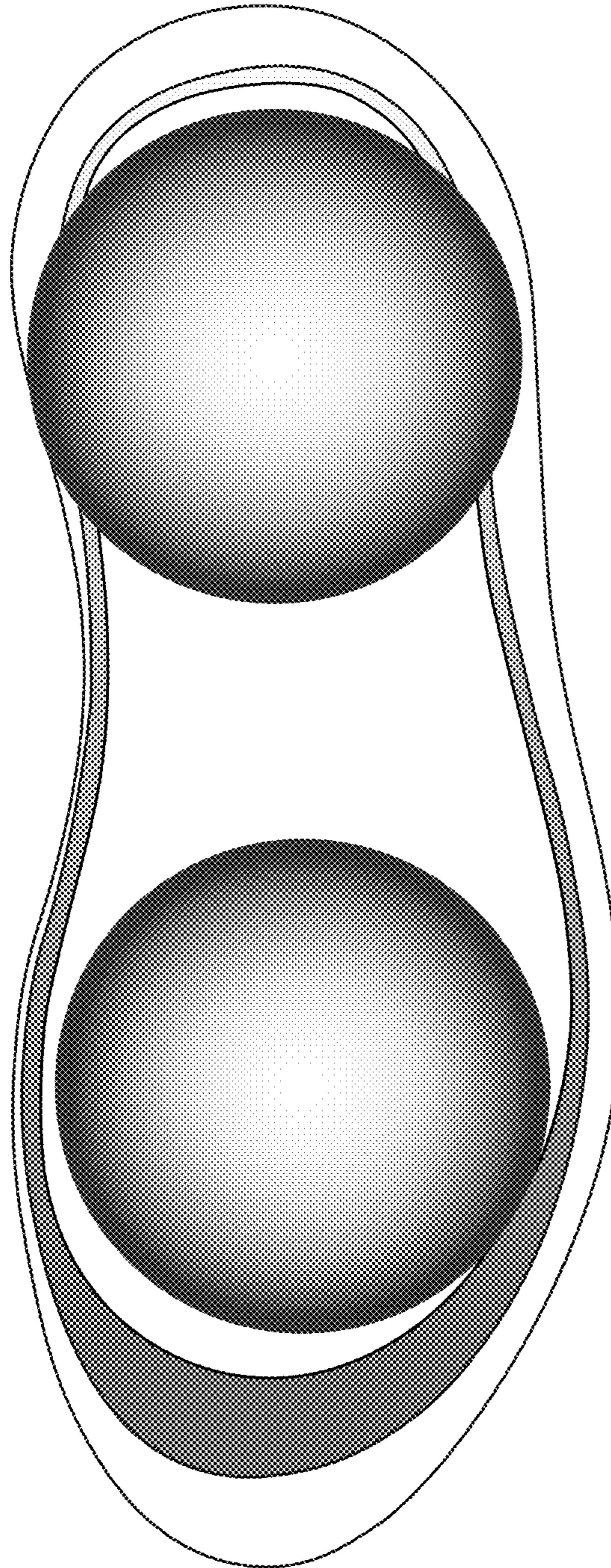

FIG. 7

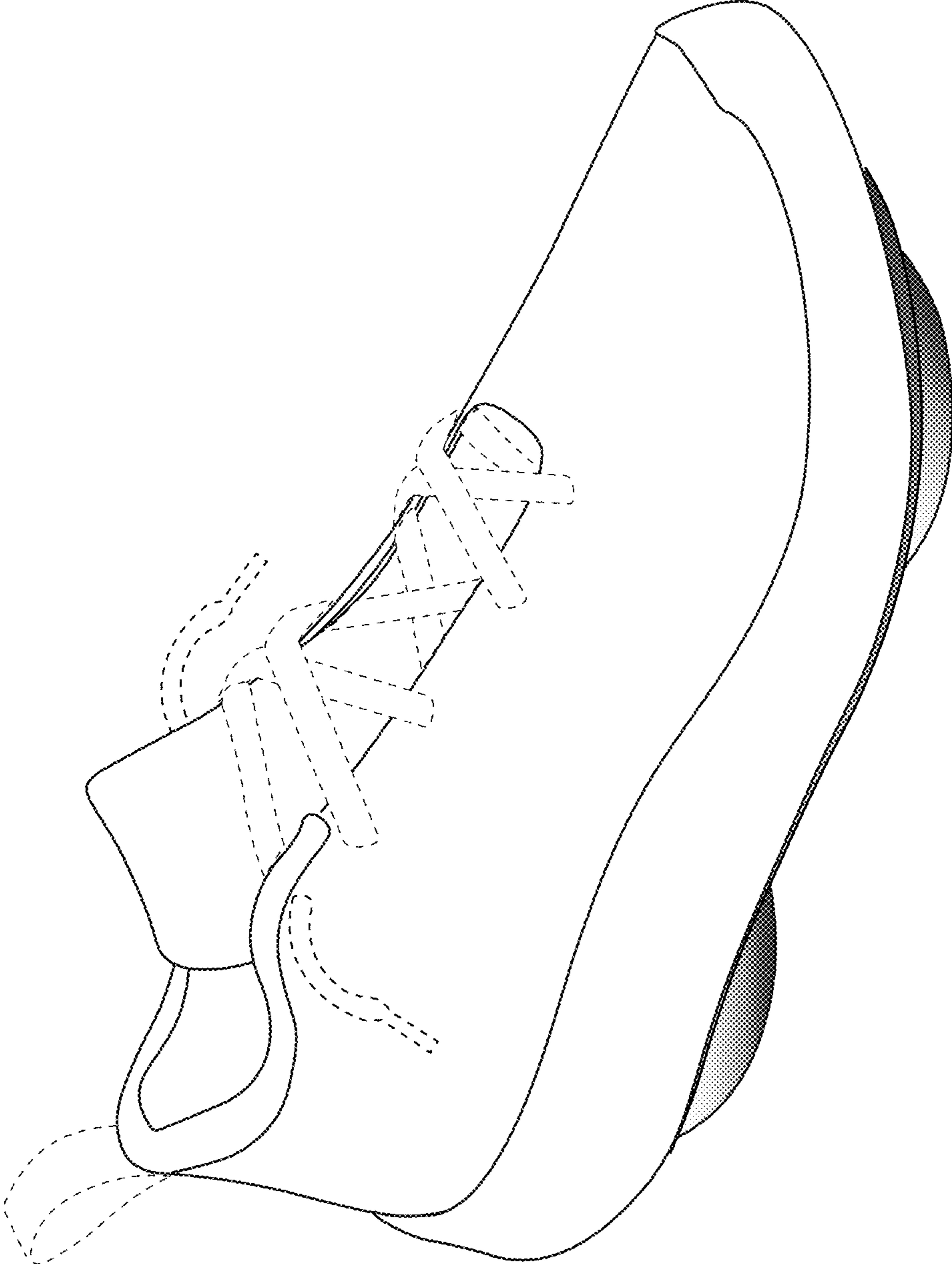

FIG. 8

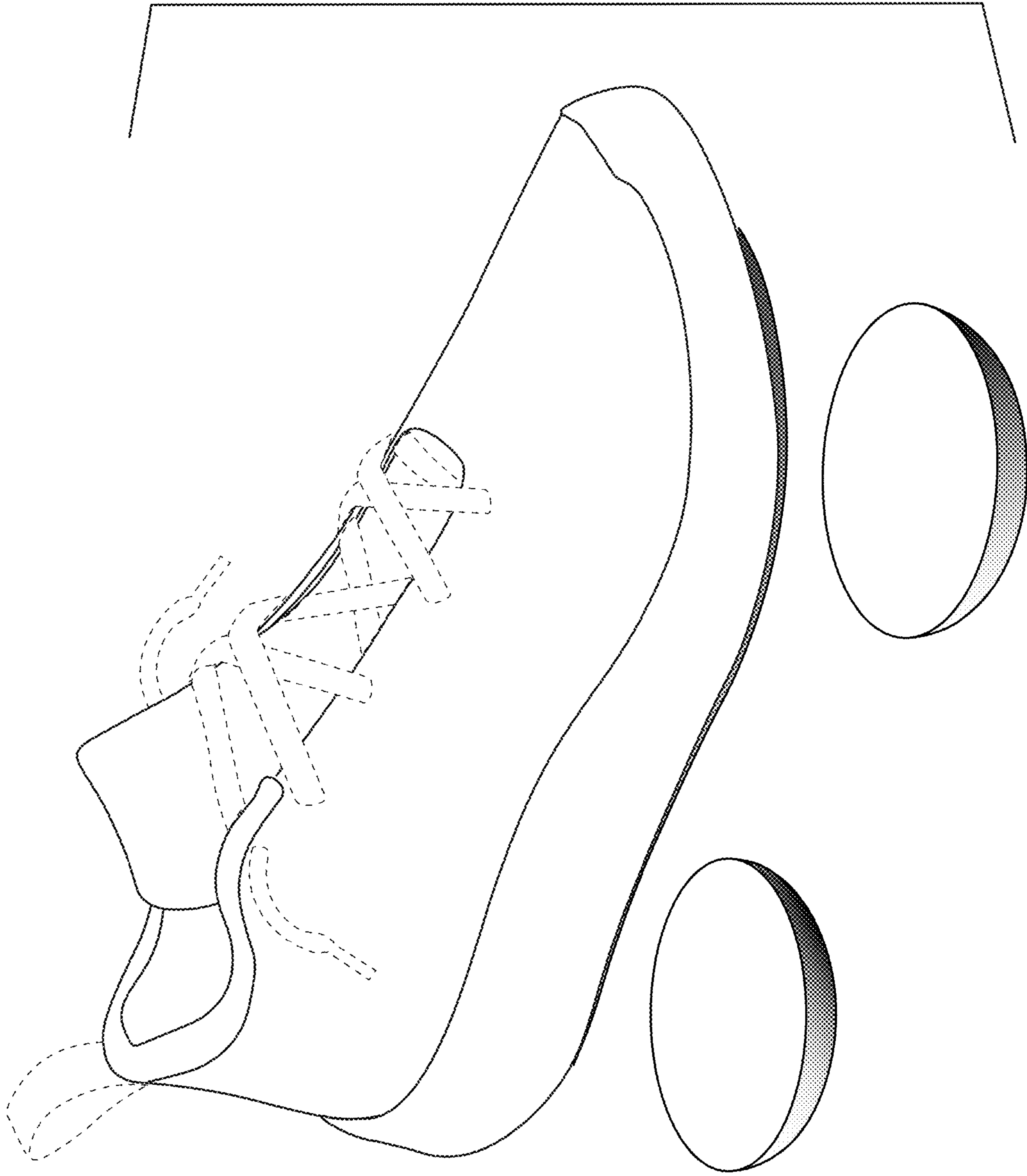

FIG. 9