

US00D963274S

(12) **United States Design Patent** (10) **Patent No.:** **US D963,274 S**
Su (45) **Date of Patent:** **** Sep. 6, 2022**

(54) **SCRAPER BLADE**
(71) Applicant: **Hong Ann Tool Industries Co., Ltd.,**
Taichung (TW)
(72) Inventor: **Cheng-Wei Su, Taichung (TW)**
(73) Assignee: **Hong Ann Tool Industries Co., Ltd.,**
Taichung (TW)
(**) Term: **15 Years**
(21) Appl. No.: **29/744,969**
(22) Filed: **Aug. 3, 2020**
(51) **LOC (13) Cl.** **07-05**
(52) **U.S. Cl.**
USPC **D32/46**
(58) **Field of Classification Search**
USPC D32/40-42, 46-49
CPC .. A47L 1/16; A47L 13/46; A47L 13/06; A47J
43/288; A63B 49/08; B25G 1/10; A01G
3/06
See application file for complete search history.

D457,269 S * 5/2002 Arey D28/47
D495,827 S * 9/2004 Branden D28/47
D497,219 S * 10/2004 Branden A47L 13/08
D28/47
D527,974 S * 9/2006 Petersen D8/90
7,621,802 B2 * 11/2009 McCarthy B24D 15/04
451/523
D659,837 S * 5/2012 Oien D24/177
D776,384 S * 1/2017 Eldridge D28/47
D837,472 S * 1/2019 Ring D32/40
D873,573 S * 1/2020 Kaicker D4/135
D905,339 S * 12/2020 Roche D28/47
D915,855 S * 4/2021 Hede D8/90

(Continued)

OTHER PUBLICATIONS

Irregular Pentagon, Protontalk website 2022, site visited Apr. 29, 2022, <https://protonstalk.com/basic-math/area-of-pentagon/>.*

(Continued)

Primary Examiner — John R Yeh
(74) *Attorney, Agent, or Firm* — Alan D. Kamrath; Karin L. Williams; Mayer & Williams PC

(57) **CLAIM**

The ornamental design for a scraper blade, as shown and described.

DESCRIPTION

FIG. 1 is a perspective view of a scraper blade showing my new design;
FIG. 2 is a front view thereof;
FIG. 3 is a rear view thereof;
FIG. 4 is a left view thereof;
FIG. 5 is a right view thereof;
FIG. 6 is a top view thereof; and,
FIG. 7 is a bottom view thereof.
The broken lines depict portions of the scraper blade that form no part of the claimed design.

1 Claim, 7 Drawing Sheets

(56) **References Cited**
U.S. PATENT DOCUMENTS
D232,146 S * 7/1974 Dean D6/584
4,525,692 A * 6/1985 Claes H03H 9/36
333/143
4,561,097 A * 12/1985 Siegel A63F 9/10
434/96
4,860,452 A * 8/1989 Guarnaccia B26B 21/56
30/346.5
4,920,702 A * 5/1990 Kloss B24D 9/08
15/97.1
D355,105 S * 2/1995 Nemazi D8/90
D365,425 S * 12/1995 Breshears D32/40
D388,572 S * 12/1997 Gold D32/46
D409,890 S * 5/1999 Longstaff D8/90
6,146,040 A * 11/2000 Dunn A47L 13/12
401/27

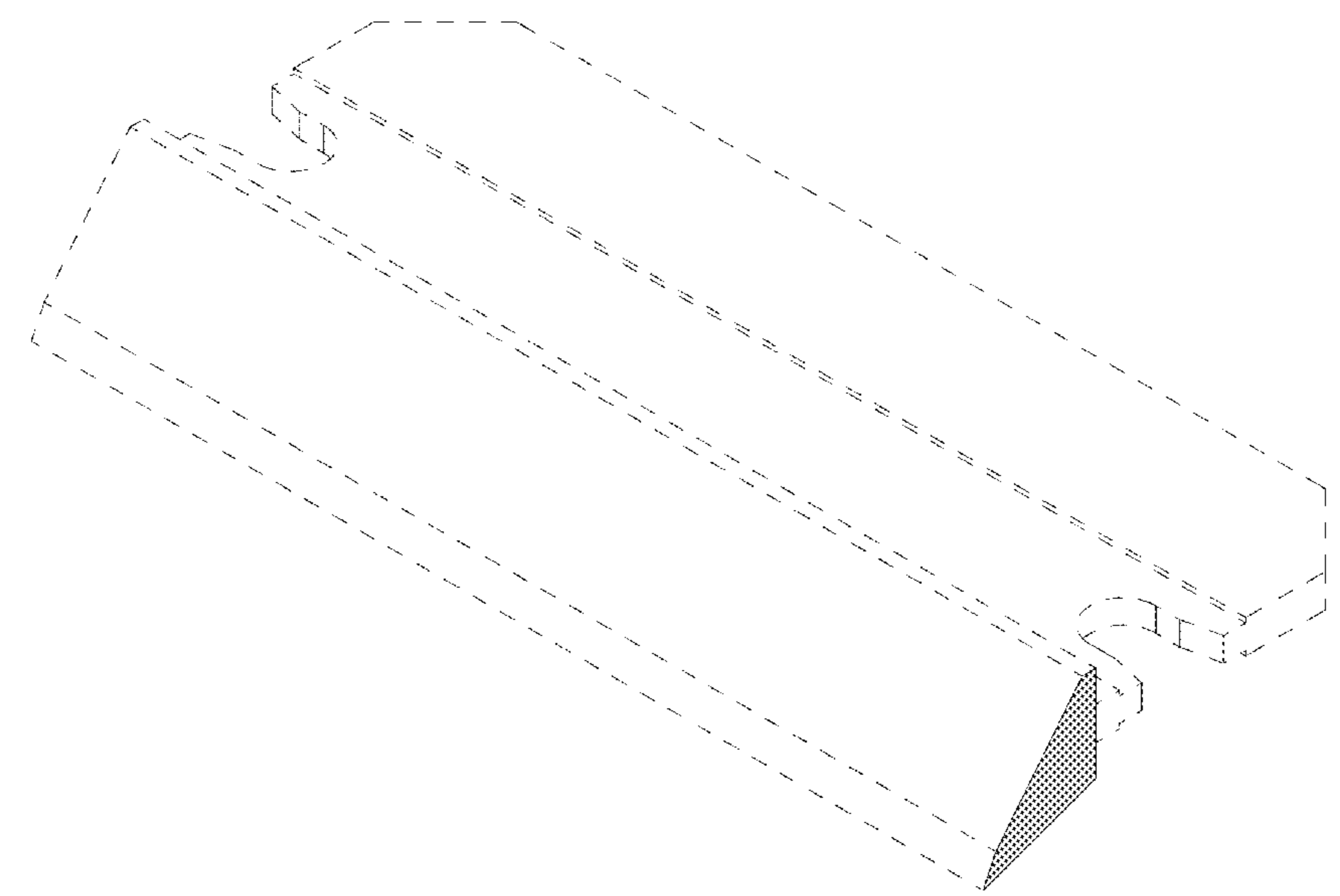

(56)

References Cited

U.S. PATENT DOCUMENTS

2013/0008033 A1* 1/2013 Fortman A01G 3/06
30/278
2013/0008036 A1* 1/2013 Gringer B26B 21/58
30/346.59
2020/0189325 A1* 6/2020 Pons B60C 11/1668

OTHER PUBLICATIONS

Husky Scraper, Home Depot reviews 2021, site visited Apr. 29, 2022, <https://www.homedepot.com/p/Husky-Contour-Scraper-with-6-Blades-410-155-0111/309896472>.*

100 pack plastic razor blade, RazorBlade website tineye image date 2017, site visited Apr. 29, 2022, <https://www.razorbladeco.com/orange-plastic-scraping-tools>.*

* cited by examiner

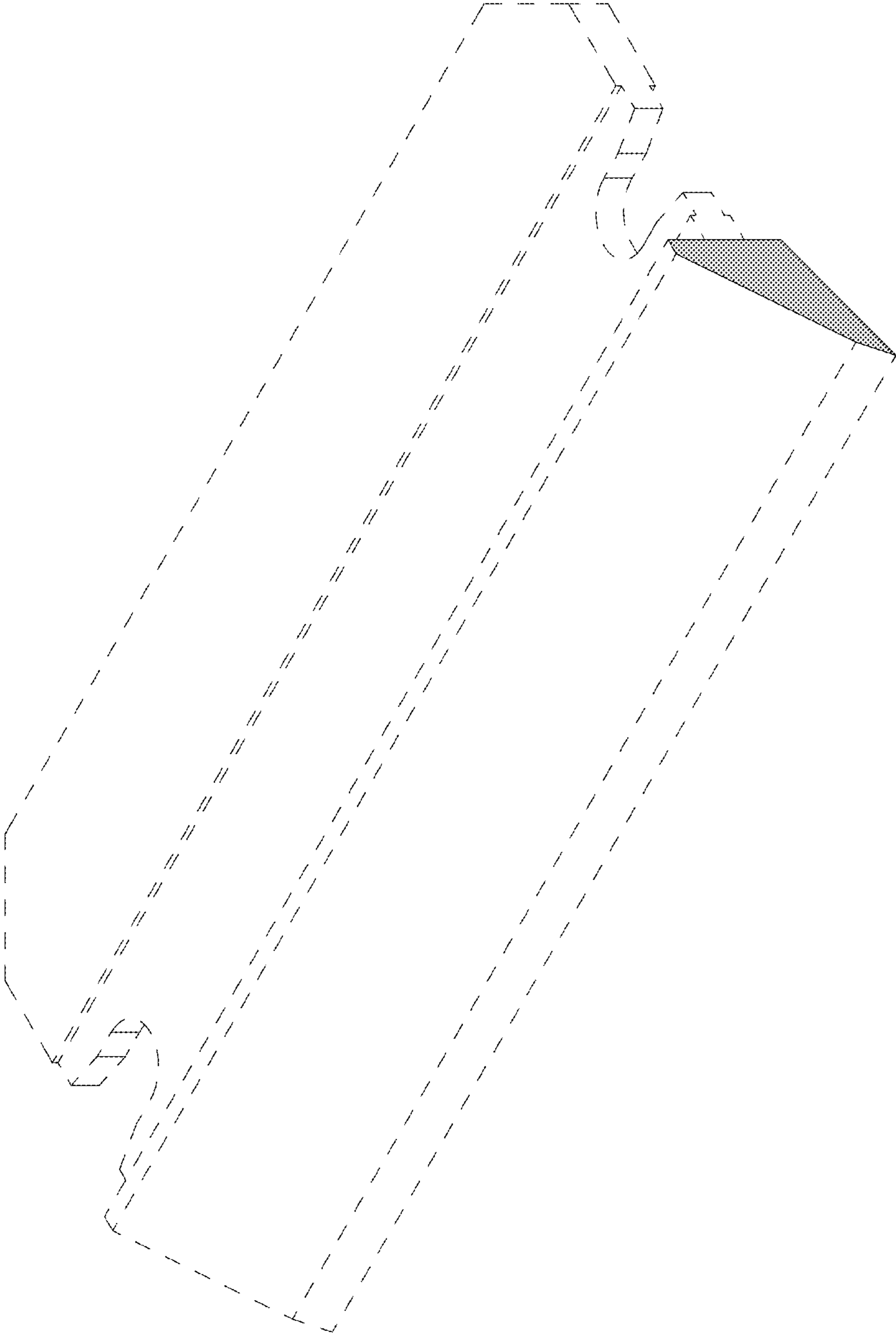

FIG. 1

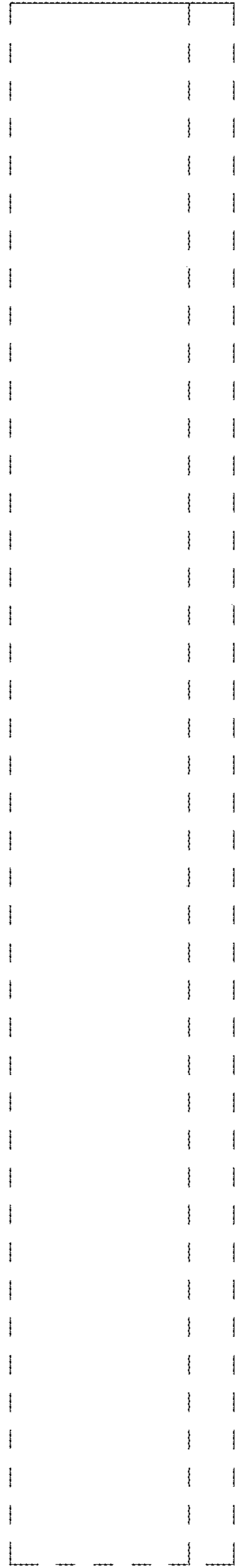

FIG. 2

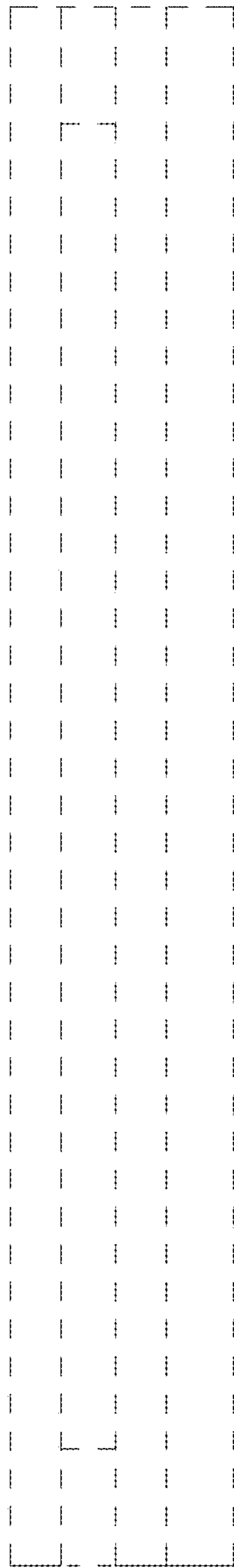

FIG. 3

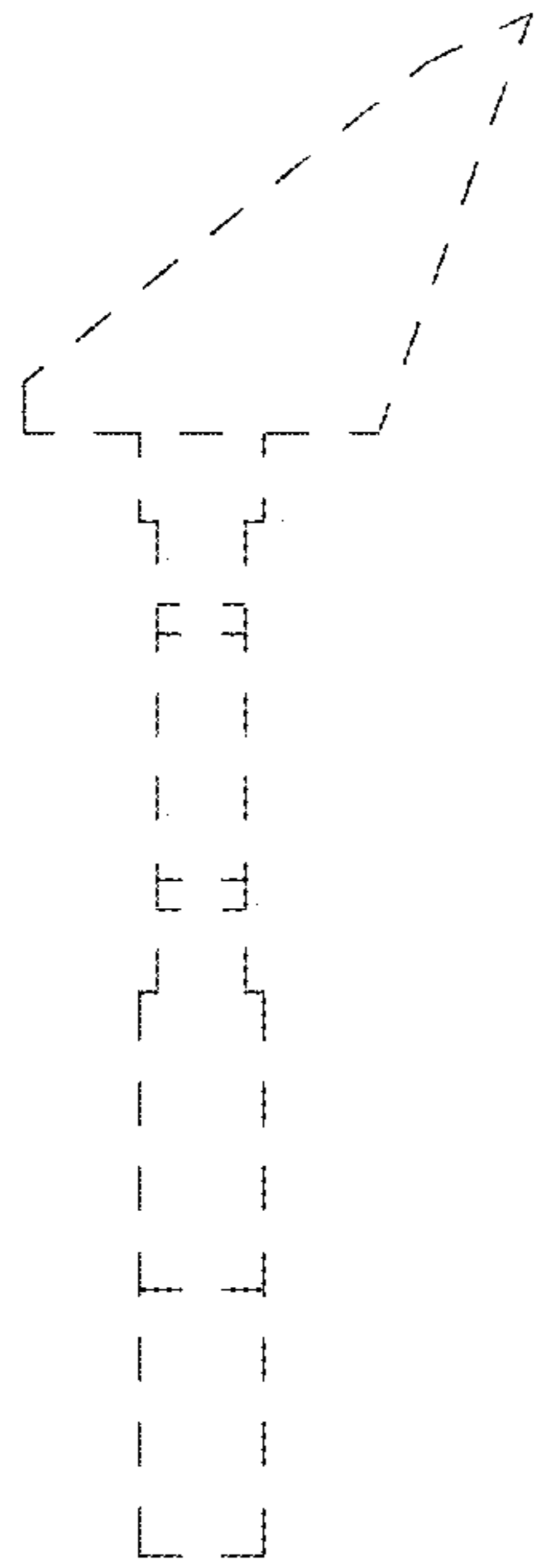

FIG. 4

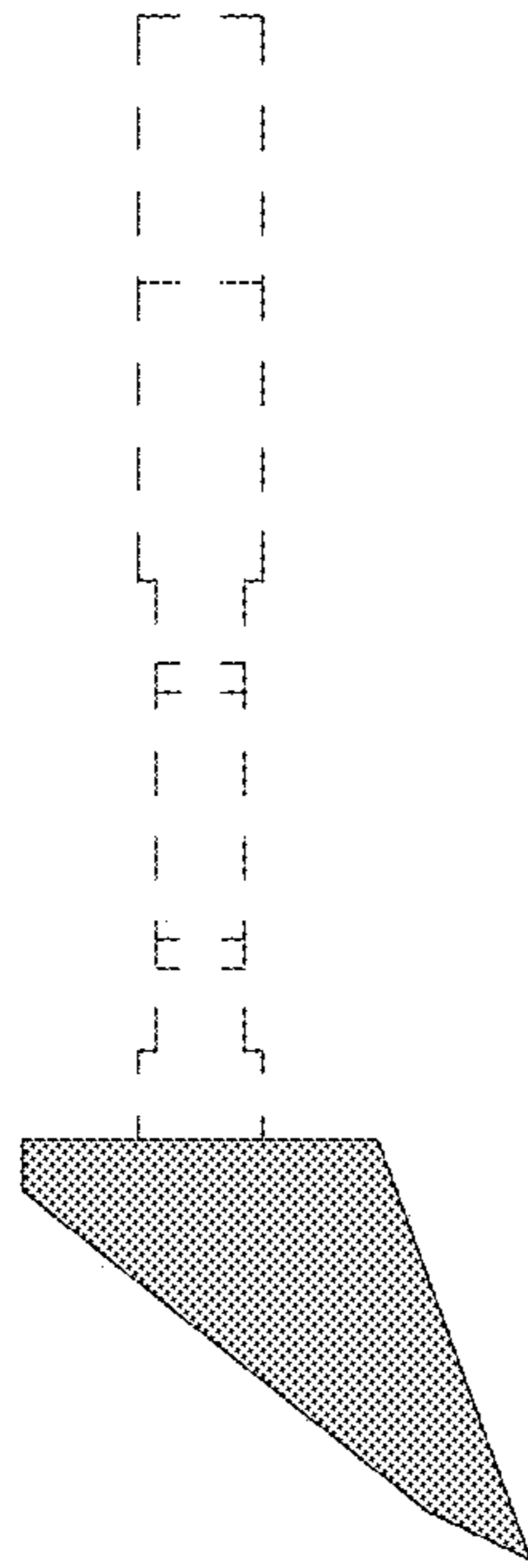

FIG. 5

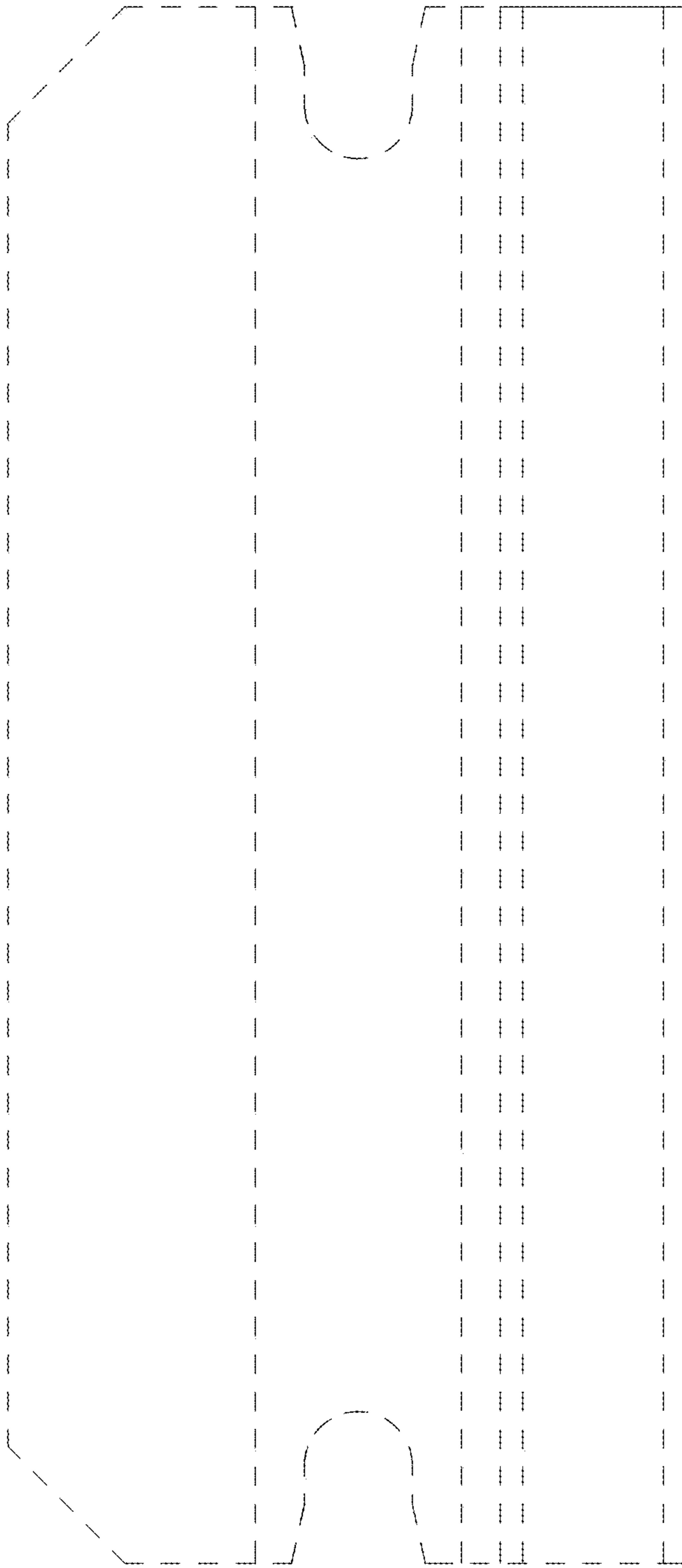

FIG. 6

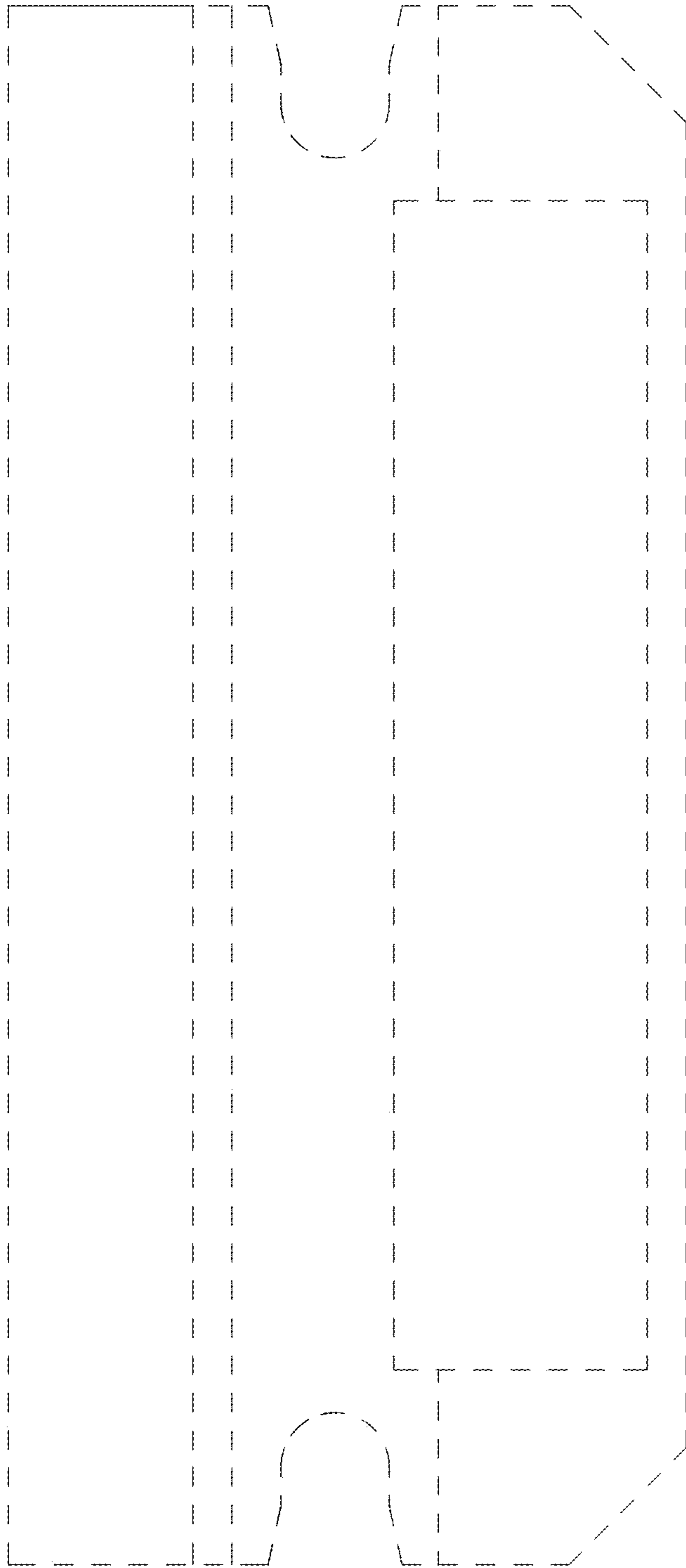

FIG. 7