



US00D963185S

(12) **United States Design Patent** (10) **Patent No.:** **US D963,185 S**
Kong (45) **Date of Patent:** **** Sep. 6, 2022**

(54) **MASSAGER**
(71) Applicant: **SUZHOU WINTECH TOOLS MANUFACTURING CO., LTD.,**
Jiangsu (CN)
(72) Inventor: **Jin-Feng Kong, Suzhou (CN)**
(73) Assignee: **SUZHOU WINTECH TOOLS MANUFACTURING CO., LTD.,**
Suzhou (CN)

(**) Term: **15 Years**

(21) Appl. No.: **29/745,394**

(22) Filed: **Aug. 5, 2020**

(30) **Foreign Application Priority Data**

Feb. 14, 2020 (CN) 202030051666.6

(51) **LOC (13) Cl.** **28-03**

(52) **U.S. Cl.**
USPC **D24/215**

(58) **Field of Classification Search**
USPC D24/200, 211, 212, 213, 214, 215;
D8/14.1; D28/13
CPC A61H 1/008; A61H 15/02; A61H
2201/1635; A61H 23/006; A61H 23/0263;
A61H 15/00; A61H 1/006
See application file for complete search history.

(56) **References Cited**

U.S. PATENT DOCUMENTS

D478,385 S * 8/2003 Dirks D24/215
D847,364 S * 4/2019 Lee D24/215

D866,790 S * 11/2019 Lee D24/215
D918,411 S * 5/2021 Xu D24/215
D920,531 S * 5/2021 Xu D24/215
D920,532 S * 5/2021 Xu D24/215
10,993,874 B1 * 5/2021 Marton A61H 23/02
D924,424 S * 7/2021 Wang D24/215
D925,751 S * 7/2021 Wu D24/211
D925,758 S * 7/2021 Xu D24/215
D928,339 S * 8/2021 Yang D24/215
D932,038 S * 9/2021 Park D24/211
D932,045 S * 9/2021 Shen D24/215
2020/0085675 A1 * 3/2020 Lee A61H 15/0085
2020/0214930 A1 * 7/2020 Wersland A61H 23/006
2020/0405574 A1 * 12/2020 Wersland A61H 1/008
2021/0022955 A1 * 1/2021 Wersland A61H 1/006
2021/0059898 A1 * 3/2021 Wersland A61H 15/00

* cited by examiner

Primary Examiner — Michael A Maharajh

(74) *Attorney, Agent, or Firm* — Metis IP LLC

(57) **CLAIM**

The ornamental design for a massager, as shown and described.

DESCRIPTION

FIG. 1 is a front, top and right perspective view of a massager showing the claimed design;
FIG. 2 is a front view thereof;
FIG. 3 is a rear view thereof;
FIG. 4 is a left side view thereof;
FIG. 5 is a right side view thereof;
FIG. 6 is a top view thereof; and,
FIG. 7 is a bottom view thereof.

1 Claim, 7 Drawing Sheets

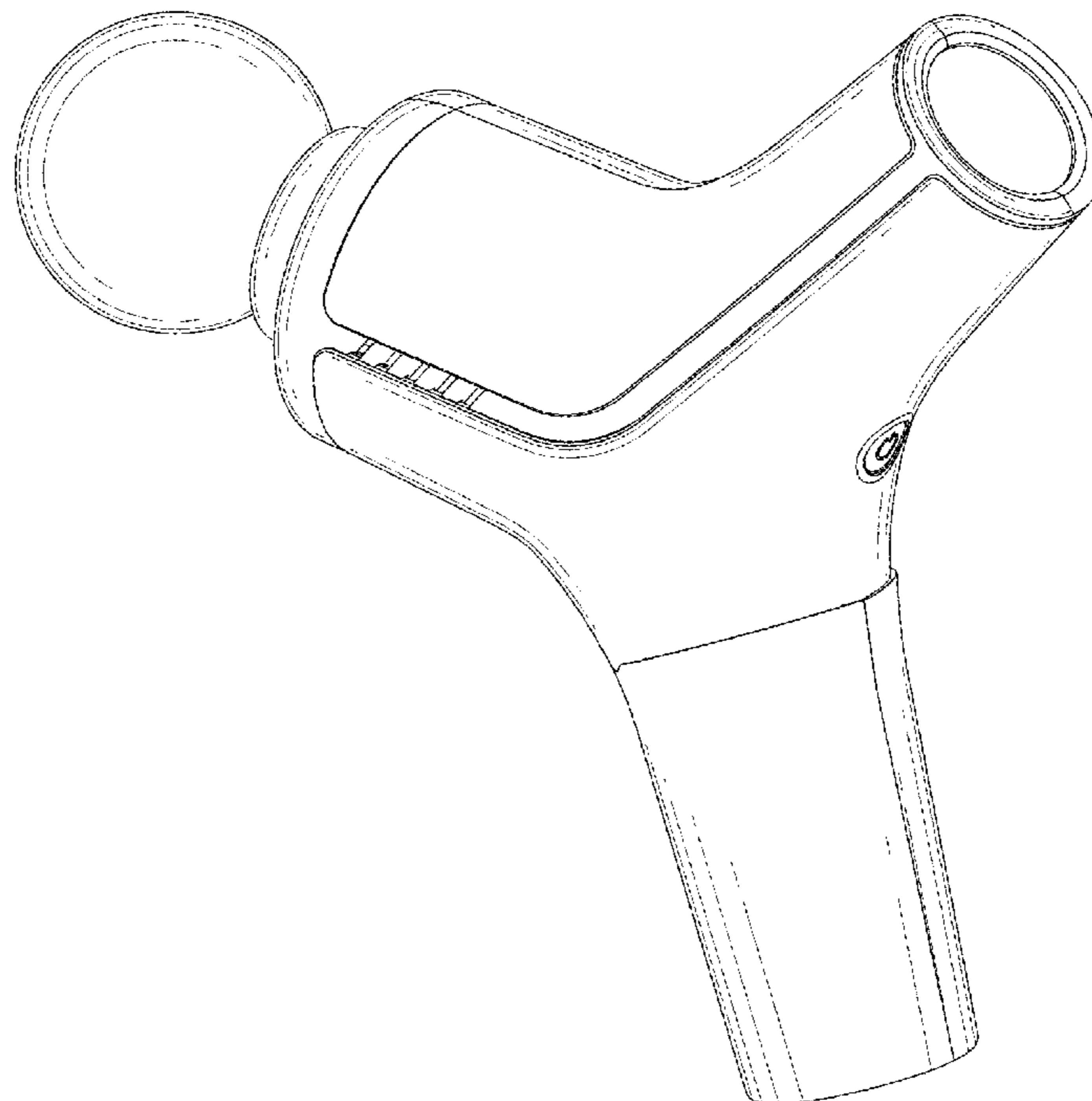

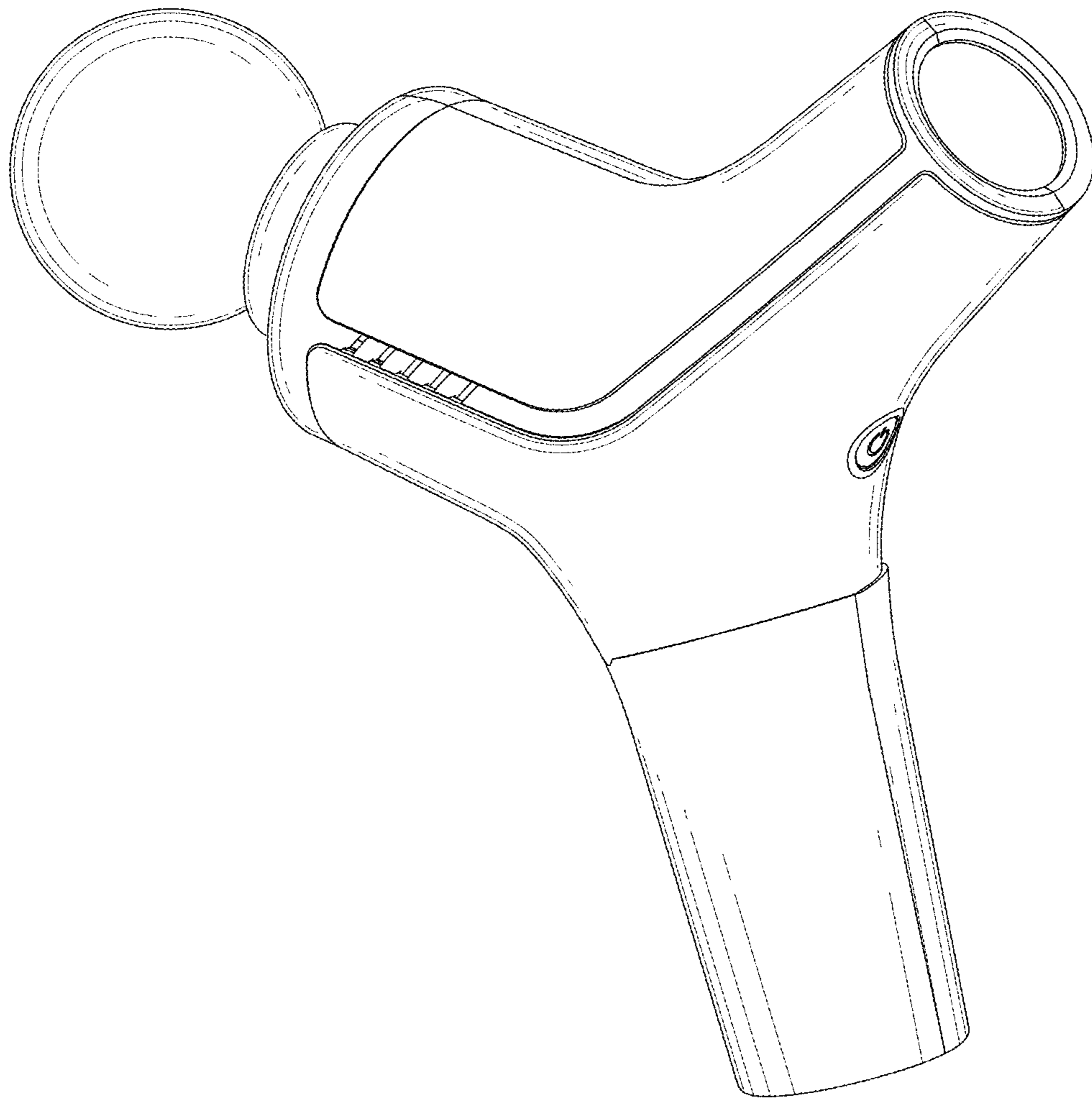

FIG. 1

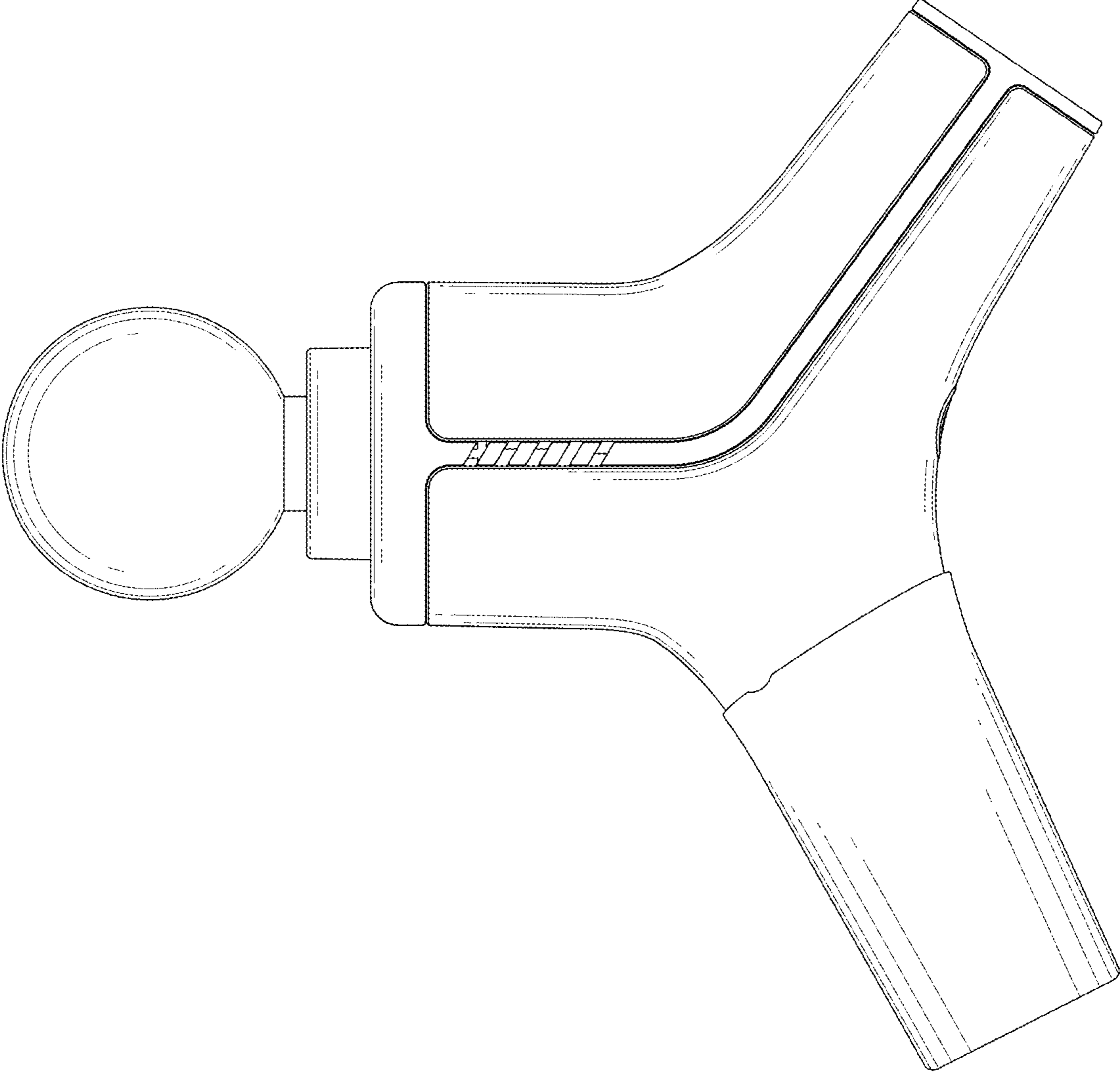

FIG. 2

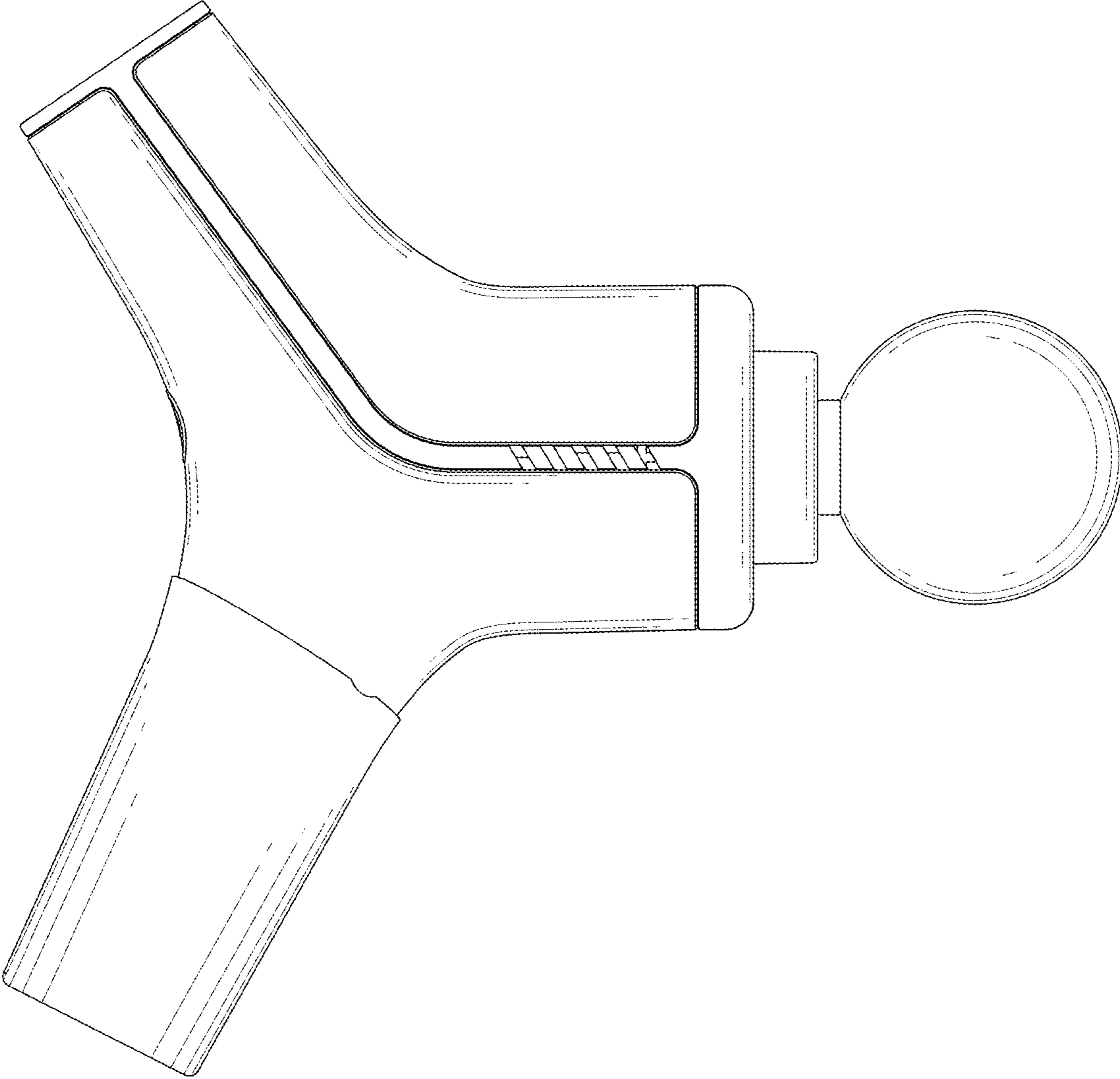

FIG. 3

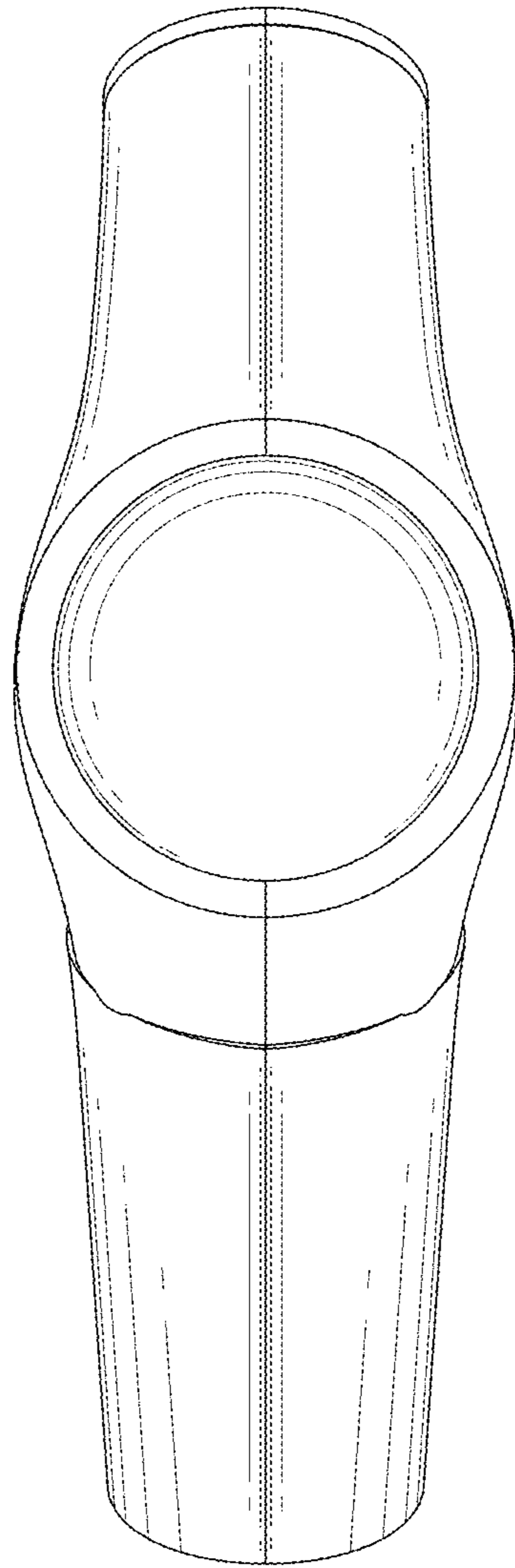

FIG. 4

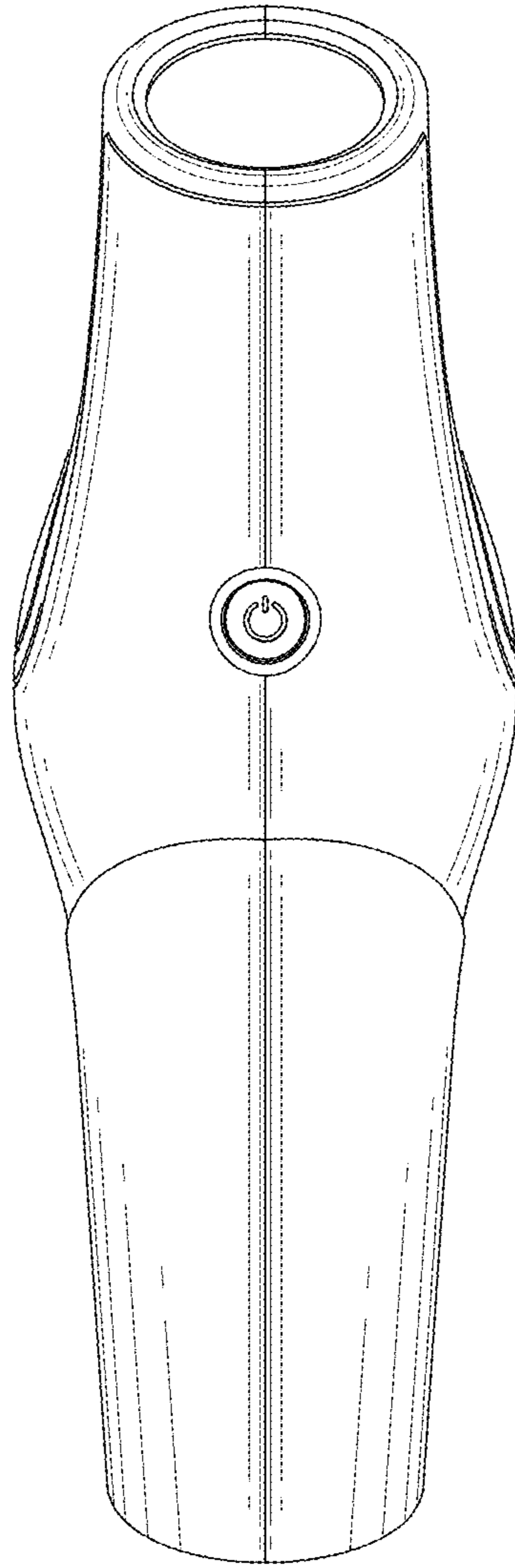

FIG. 5

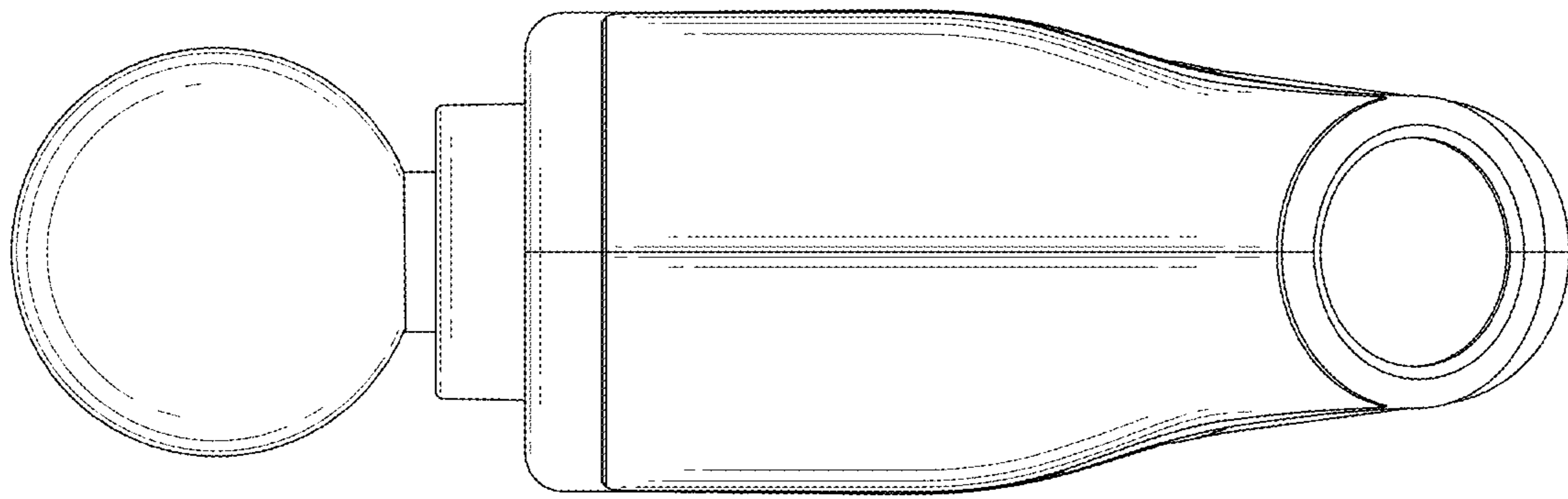

FIG. 6

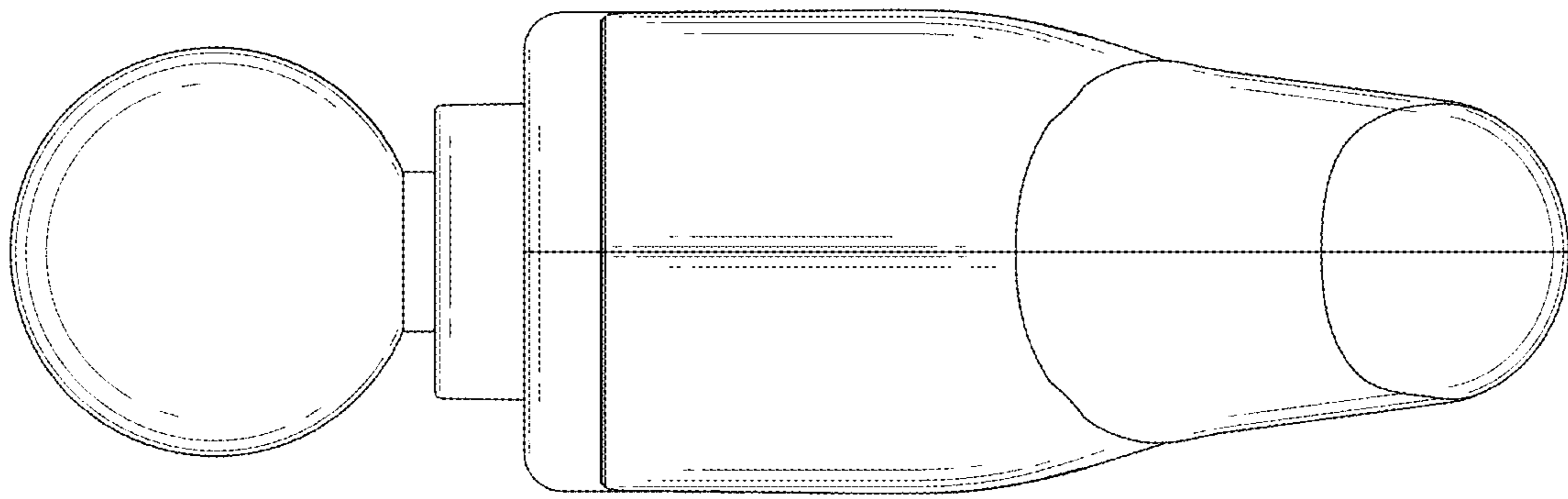

FIG. 7