



US00D963125S

(12) **United States Design Patent** (10) **Patent No.:** **US D963,125 S**
Shell (45) **Date of Patent:** **** Sep. 6, 2022**

(54) **FAUCET HANDLE**
(71) Applicant: **DELTA FAUCET COMPANY,**
Indianapolis, IN (US)
(72) Inventor: **Derel Juva Shell,** Merrillville, IN
(US)
(73) Assignee: **DELTA FAUCET COMPANY,**
Indianapolis, IN (US)
(**) Term: **15 Years**
(21) Appl. No.: **29/775,797**
(22) Filed: **Mar. 25, 2021**
(51) **LOC (13) Cl.** **23-01**
(52) **U.S. Cl.**
USPC **D23/252**
(58) **Field of Classification Search**
USPC D23/238-243, 249-250, 252;
D8/307-308
See application file for complete search history.

D810,243 S * 2/2018 Schoenherr D23/242
D810,885 S * 2/2018 Bahler D23/252
D839,996 S * 2/2019 Garland D23/252
D840,512 S * 2/2019 Garland D23/252
D846,708 S * 4/2019 Garland D23/252
D851,735 S * 6/2019 Bahler D23/252
D852,330 S * 6/2019 Garland D23/252
D855,775 S * 8/2019 McKeone D23/250
11,214,947 B2 * 1/2022 Rosko E03C 1/0404

* cited by examiner
Primary Examiner — Robert A Delehanty
(74) *Attorney, Agent, or Firm* — Nirav D. Parikh; Jeffrey
L. Doyle

(57) **CLAIM**
The ornamental design for a faucet handle, as shown and
described.

DESCRIPTION
FIG. 1 is a front perspective view of a faucet handle showing
my new design;
FIG. 2 is a rear perspective view thereof;
FIG. 3 is a front elevational view thereof;
FIG. 4 is a left side view thereof;
FIG. 5 is a rear view thereof;
FIG. 6 is a right side view thereof;
FIG. 7 is a top plan view thereof; and,
FIG. 8 is a bottom view thereof.

(56) **References Cited**
U.S. PATENT DOCUMENTS
D540,917 S * 4/2007 Kikuchi D23/242
D665,880 S * 8/2012 Flowers D23/252
D665,881 S * 8/2012 Flowers D23/252

1 Claim, 4 Drawing Sheets

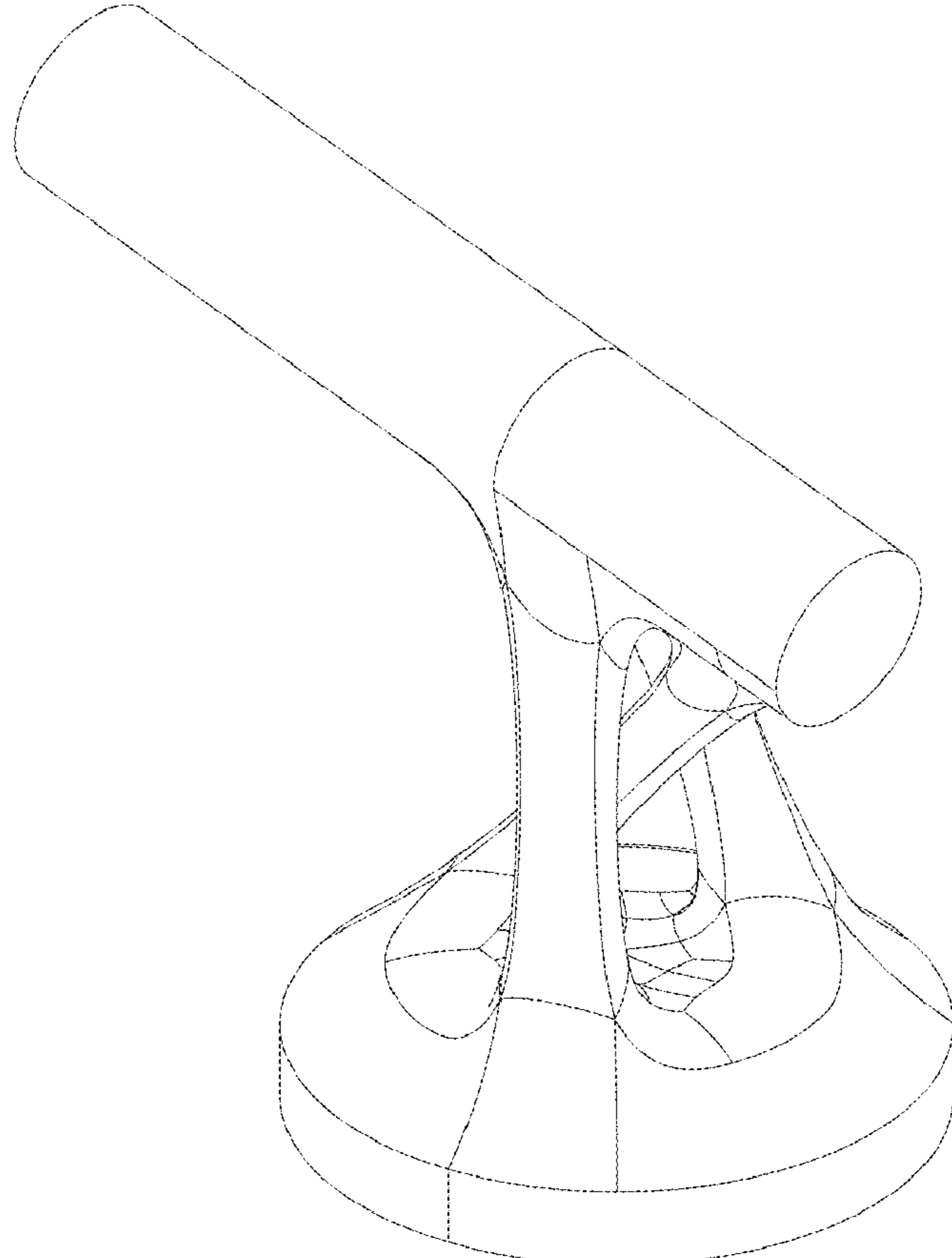

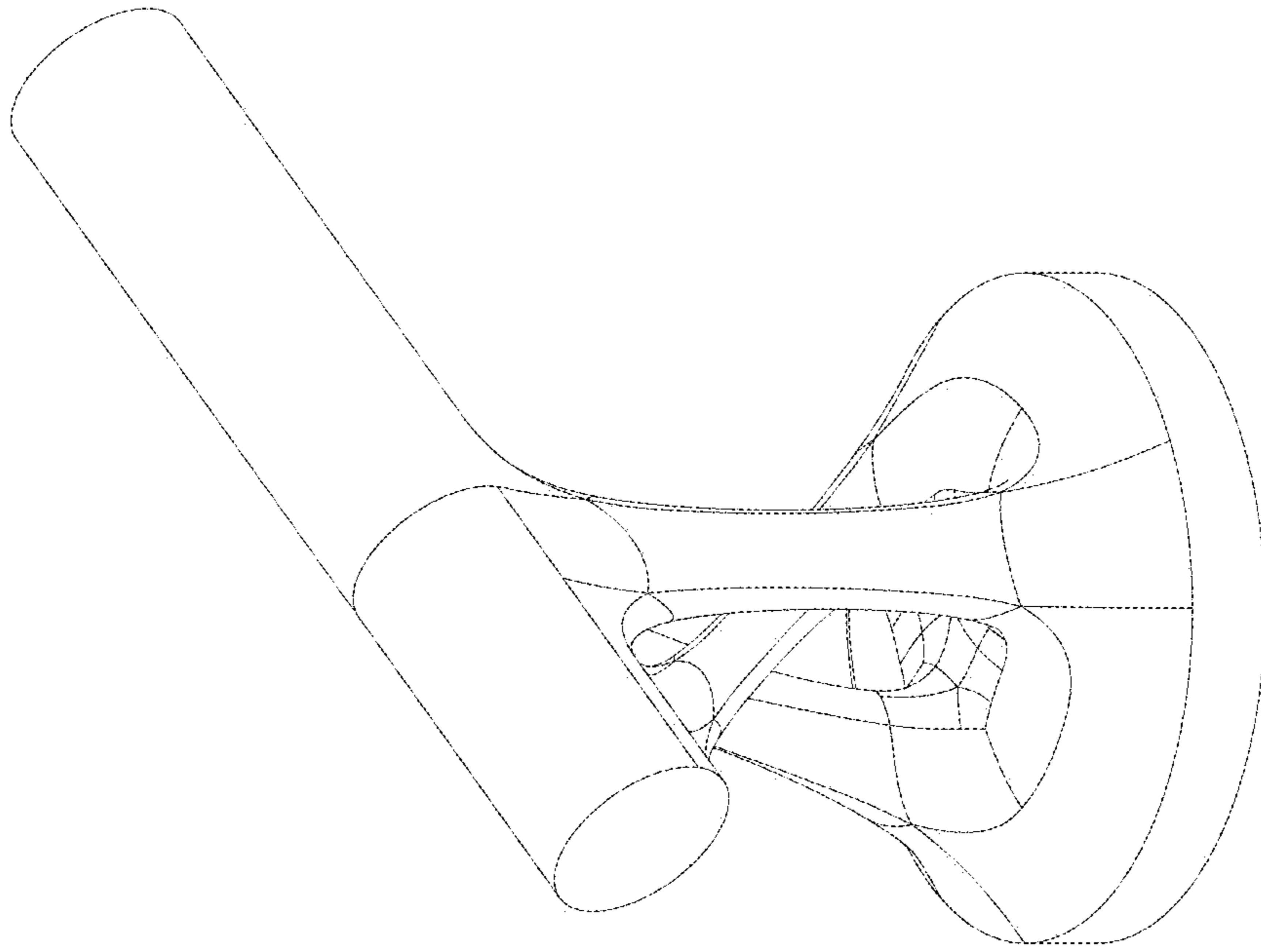

FIG - 2

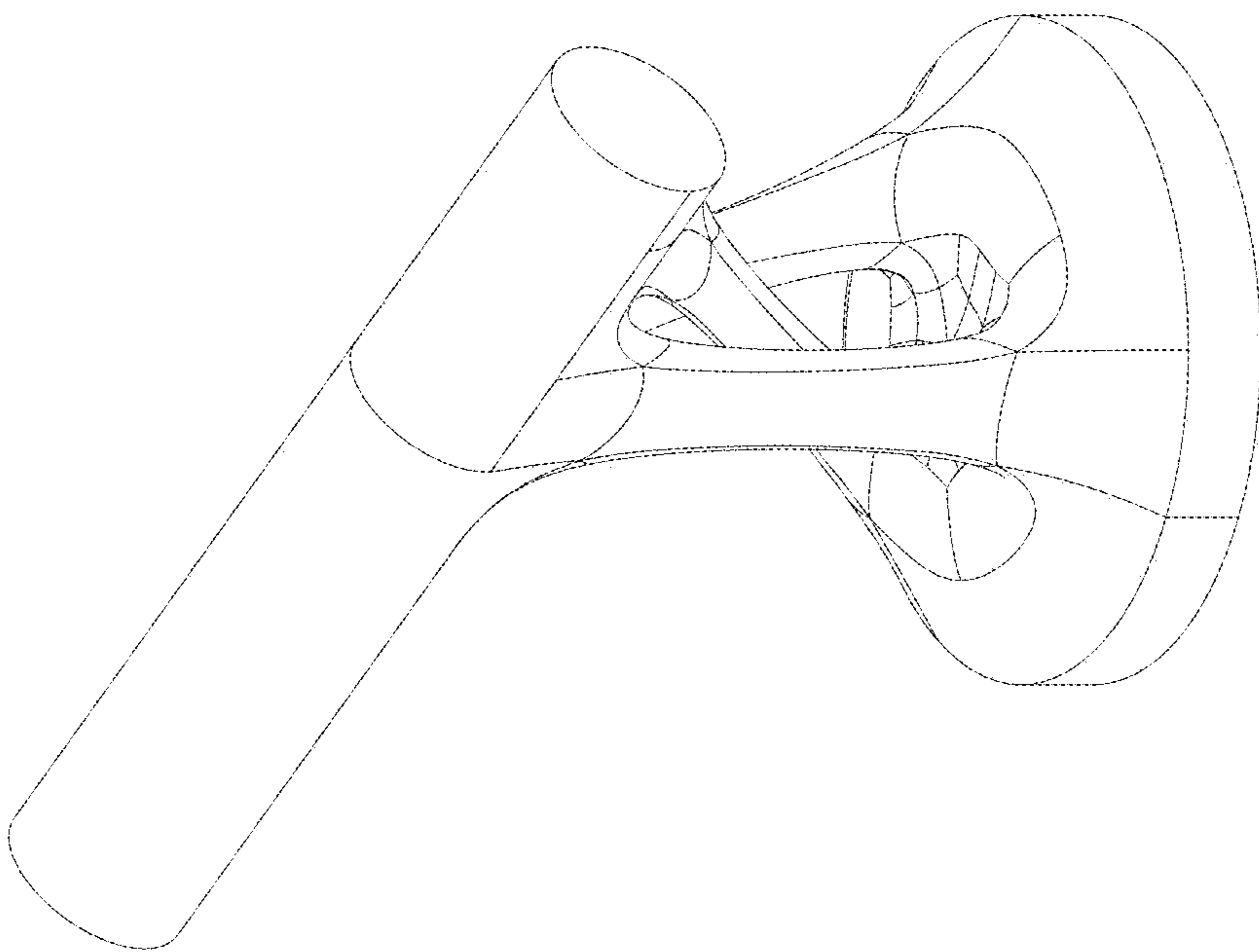

FIG - 1

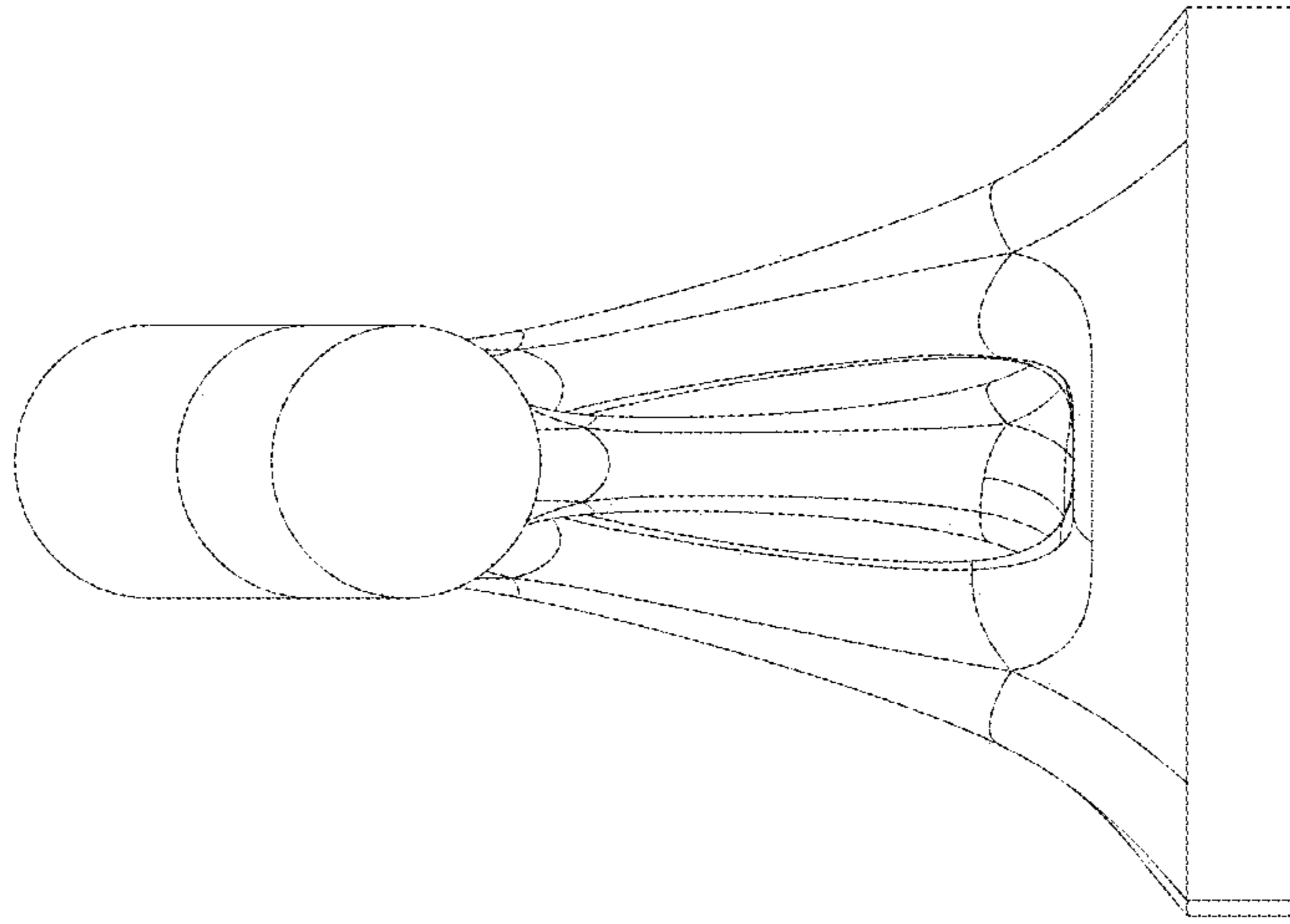

FIG - 4

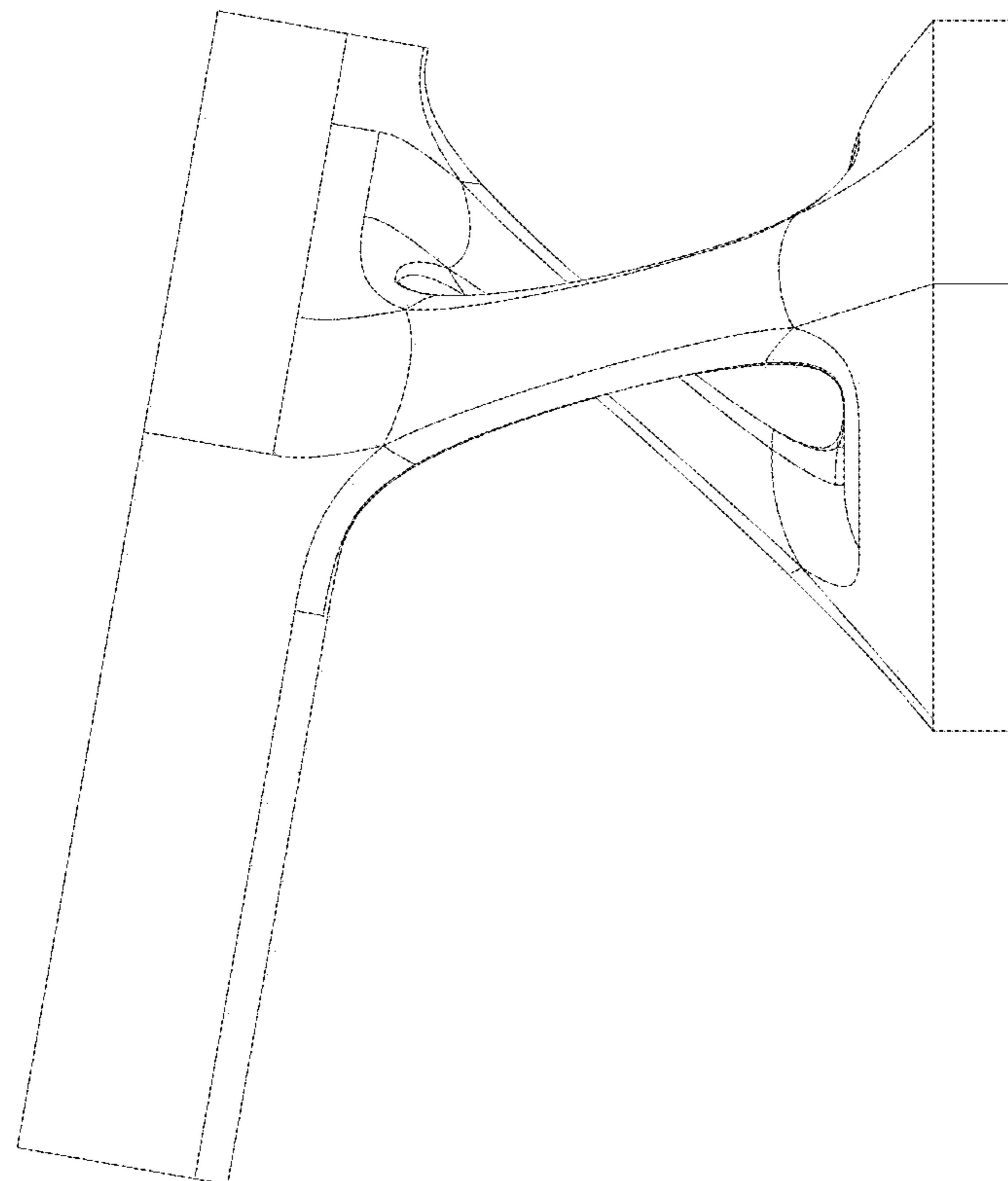

FIG - 3

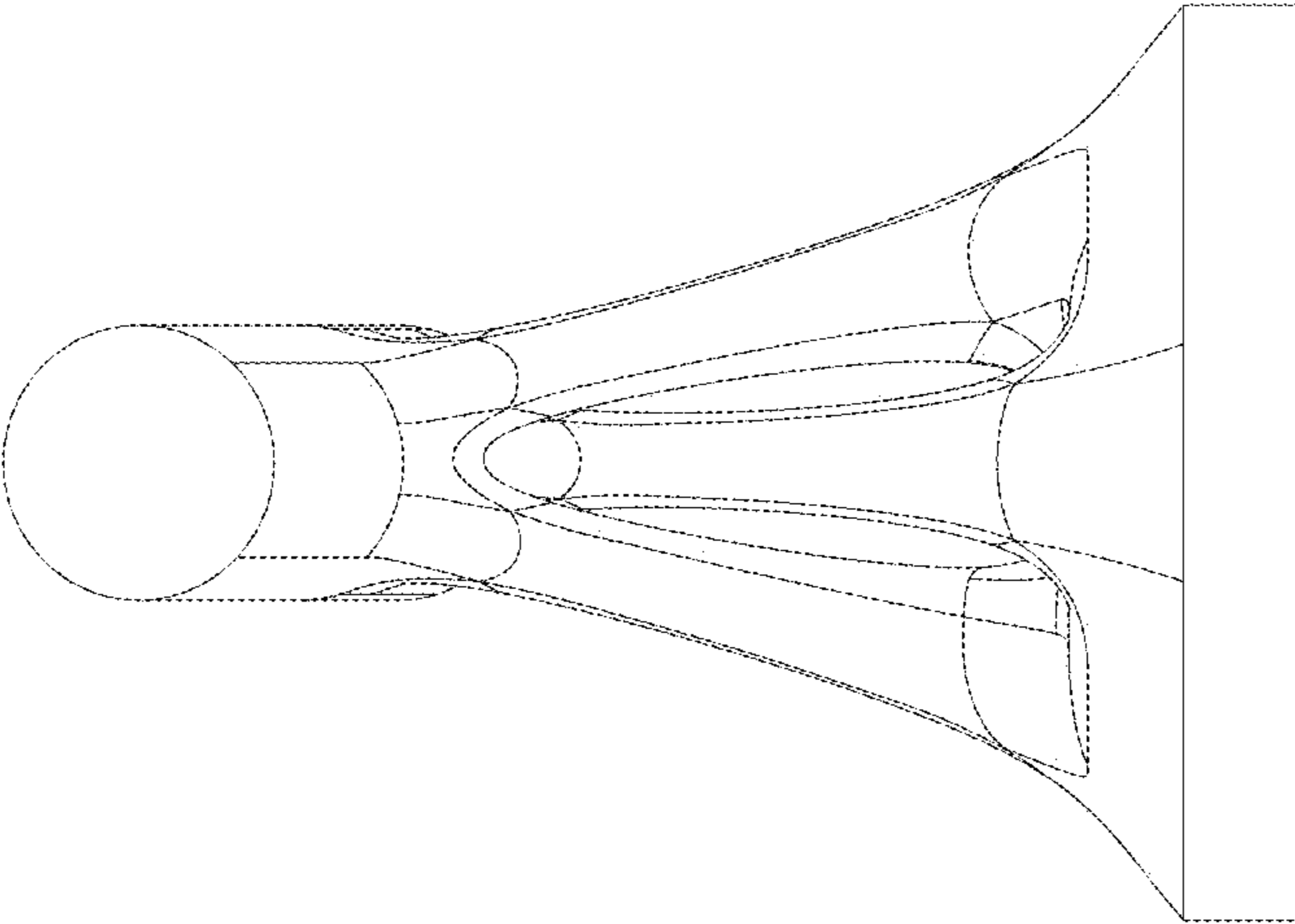

FIG - 6

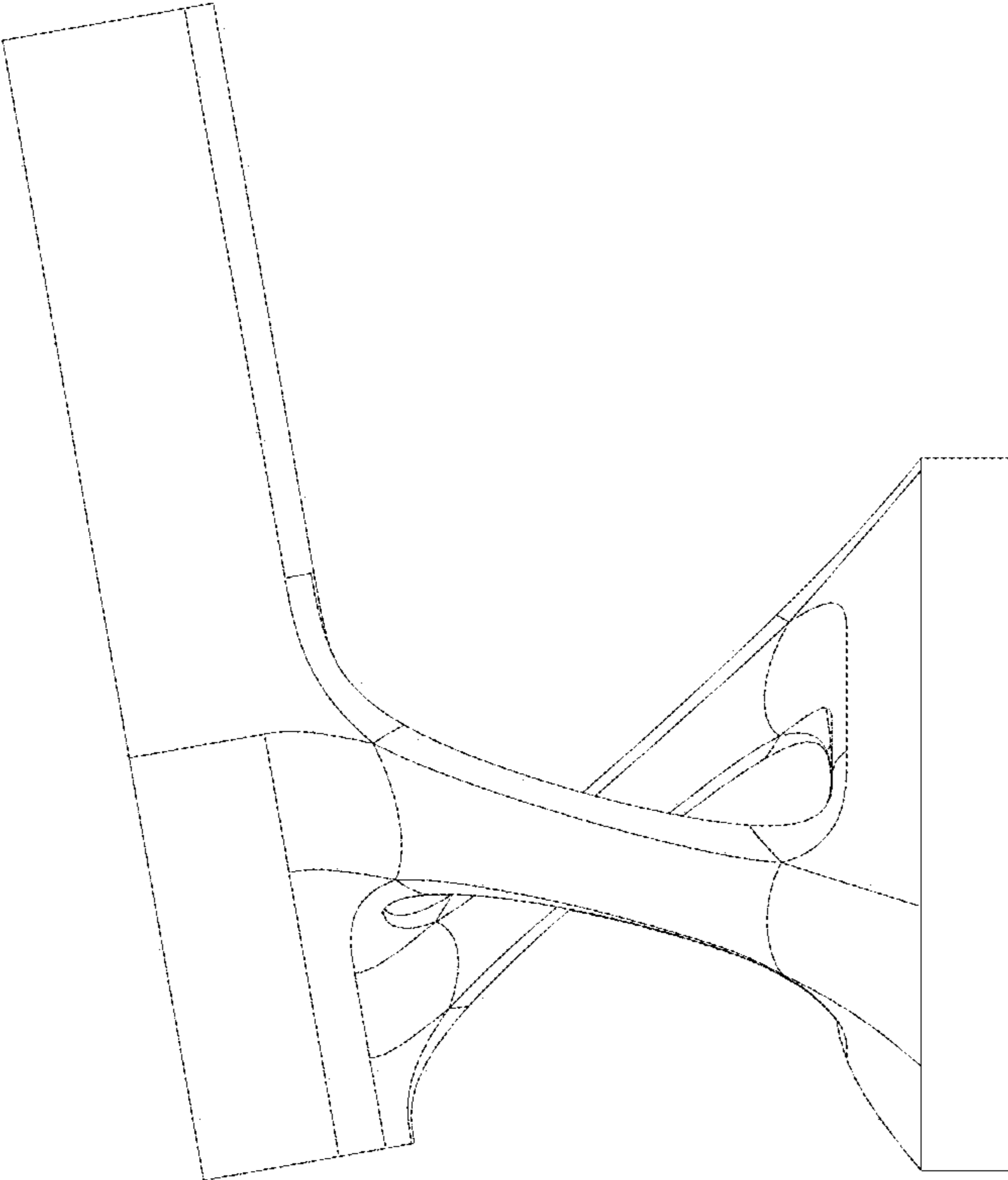

FIG - 5

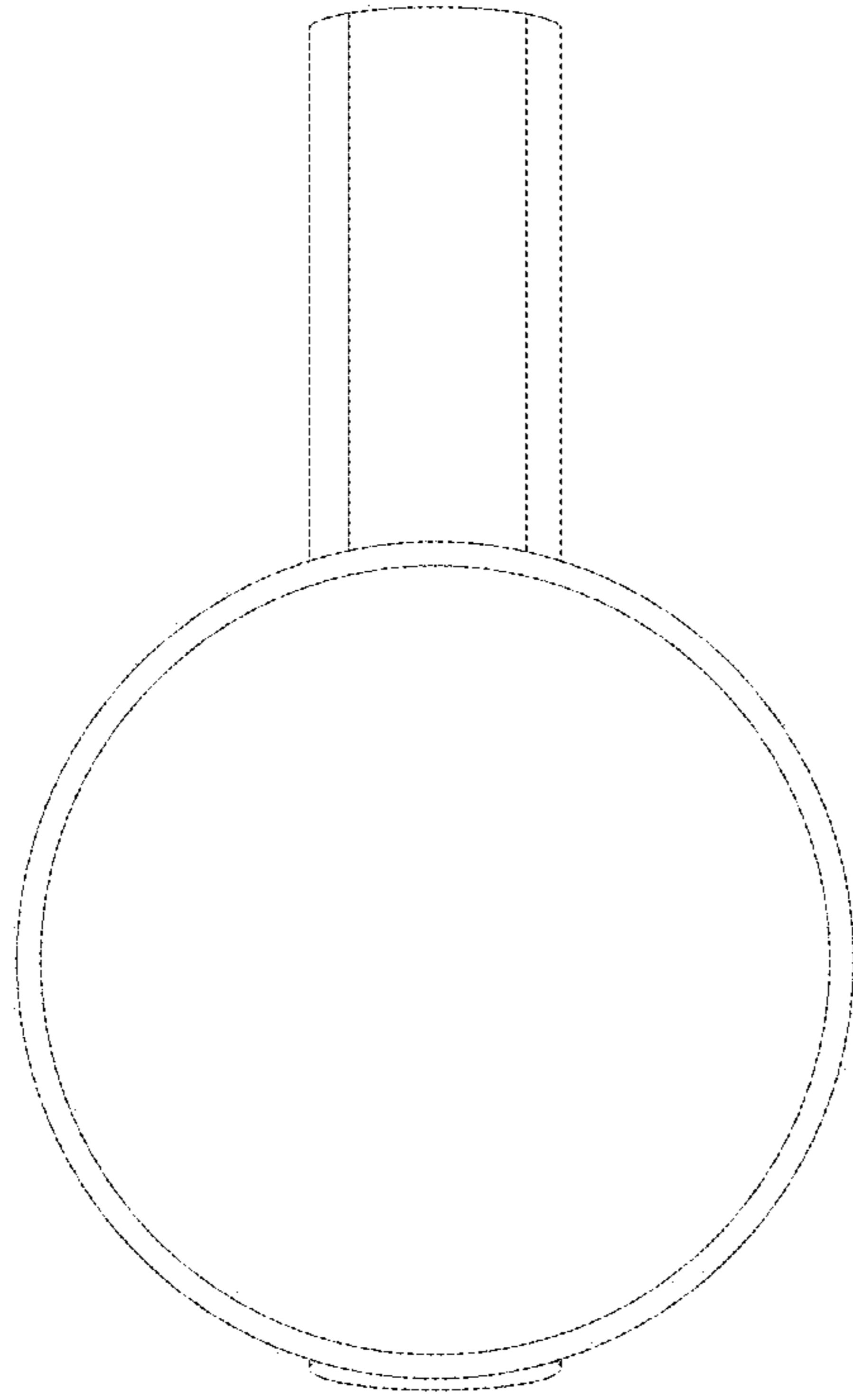

FIG - 8

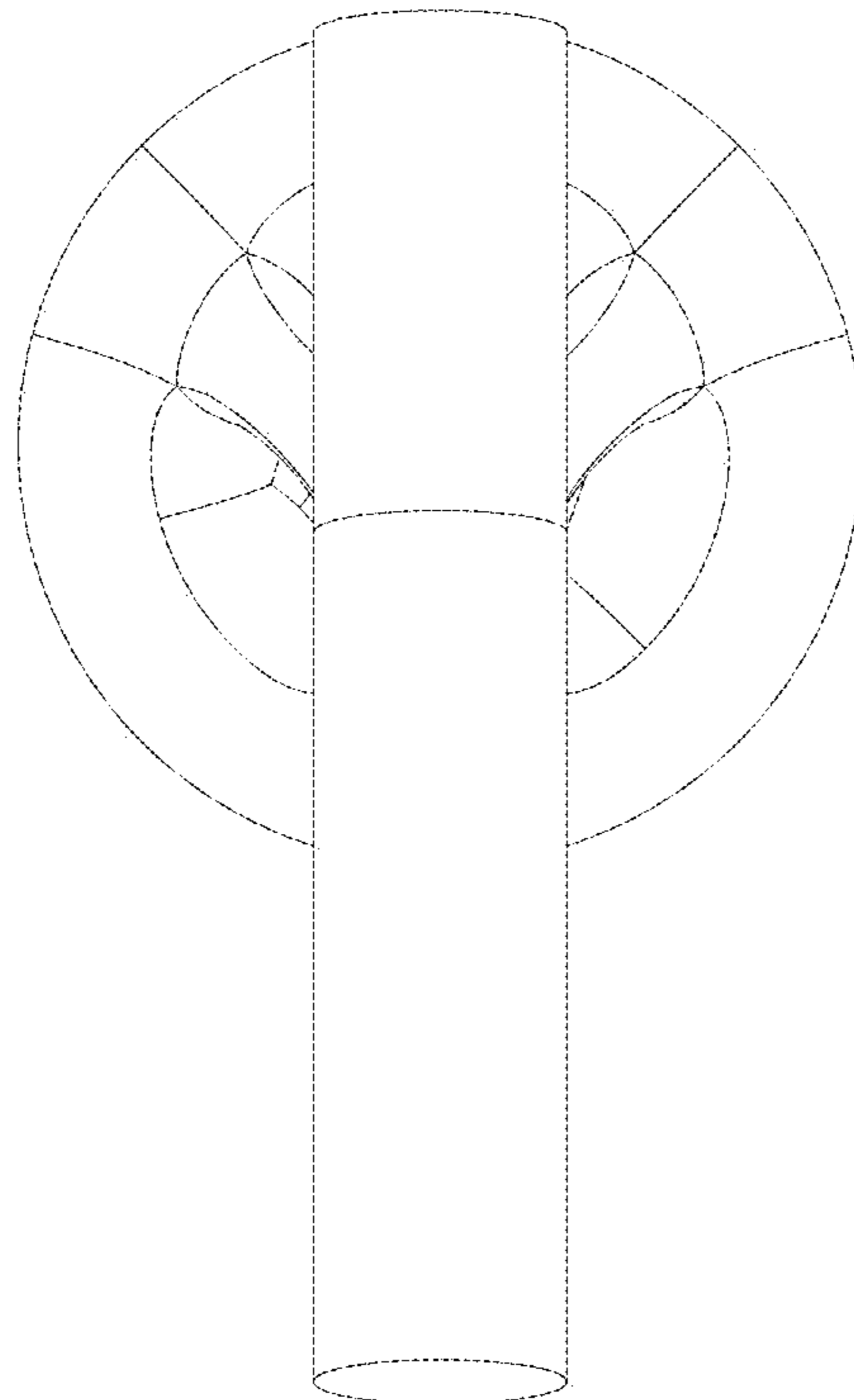

FIG - 7