



US00D963091S

(12) **United States Design Patent** (10) **Patent No.:** **US D963,091 S**  
**Chun et al.** (45) **Date of Patent:** **\*\* Sep. 6, 2022**

(54) **IRON GOLF CLUB HEAD**

(71) Applicant: **Acushnet Company**, Fairhaven, MA (US)

(72) Inventors: **Kevin J. Chun**, Encinitas, CA (US);  
**Ryan J. A. Ritchie**, San Marcos, CA (US)

(73) Assignee: **Acushnet Company**, Fairhaven, MA (US)

(\*\*) Term: **15 Years**

(21) Appl. No.: **29/762,406**

(22) Filed: **Dec. 16, 2020**

**Related U.S. Application Data**

(63) Continuation-in-part of application No. 29/741,250, filed on Jul. 10, 2020, now Pat. No. Des. 947,971.

(51) **LOC (13) Cl.** ..... **21-02**

(52) **U.S. Cl.**  
USPC ..... **D21/747**

(58) **Field of Classification Search**  
USPC ..... D21/747-751, 759  
CPC ..... A63B 53/00; A63B 53/02; A63B 53/04;  
A63B 53/047; A63B 53/0475; A63B  
2053/0479; A63B 2053/0483; A63B  
2053/0445; A63B 60/00; A63B 60/46

See application file for complete search history.

(56) **References Cited**

U.S. PATENT DOCUMENTS

D763,375 S *	8/2016	Chun .....	D21/747
D803,960 S *	11/2017	Hebreo .....	D21/749
D894,303 S *	8/2020	Song .....	D21/747
D910,128 S *	2/2021	Kitching, Jr. ....	D21/747
D926,272 S *	7/2021	Cleghorn .....	D21/747
D947,971 S *	4/2022	Chun .....	D21/747

\* cited by examiner

*Primary Examiner* — Mitchell I. Siegel

(74) *Attorney, Agent, or Firm* — Randy K. Chang

(57) **CLAIM**

The ornamental design for iron golf club head, as shown and described.

**DESCRIPTION**

FIG. 1 is a perspective back view of my new design for an iron golf club head;  
FIG. 2 is a heel end view thereof;  
FIG. 3 is a toe end view thereof;  
FIG. 4 is a top plan view thereof;  
FIG. 5 is a rear elevational view thereof;  
FIG. 6 is a front elevation view thereof; and,  
FIG. 7 is a bottom plan view thereof.

The broken lines shown form no part of the claimed design.

**1 Claim, 3 Drawing Sheets**

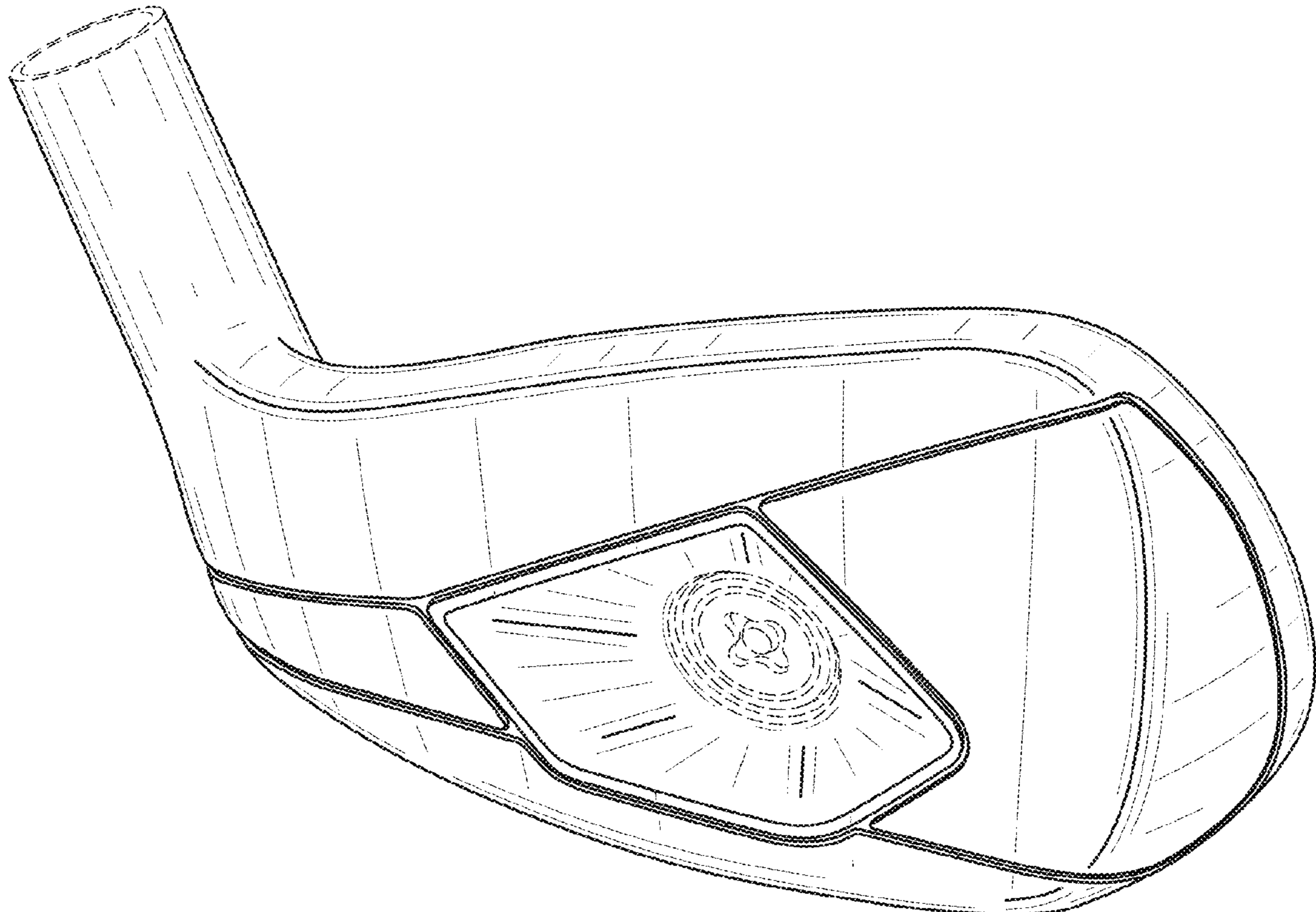

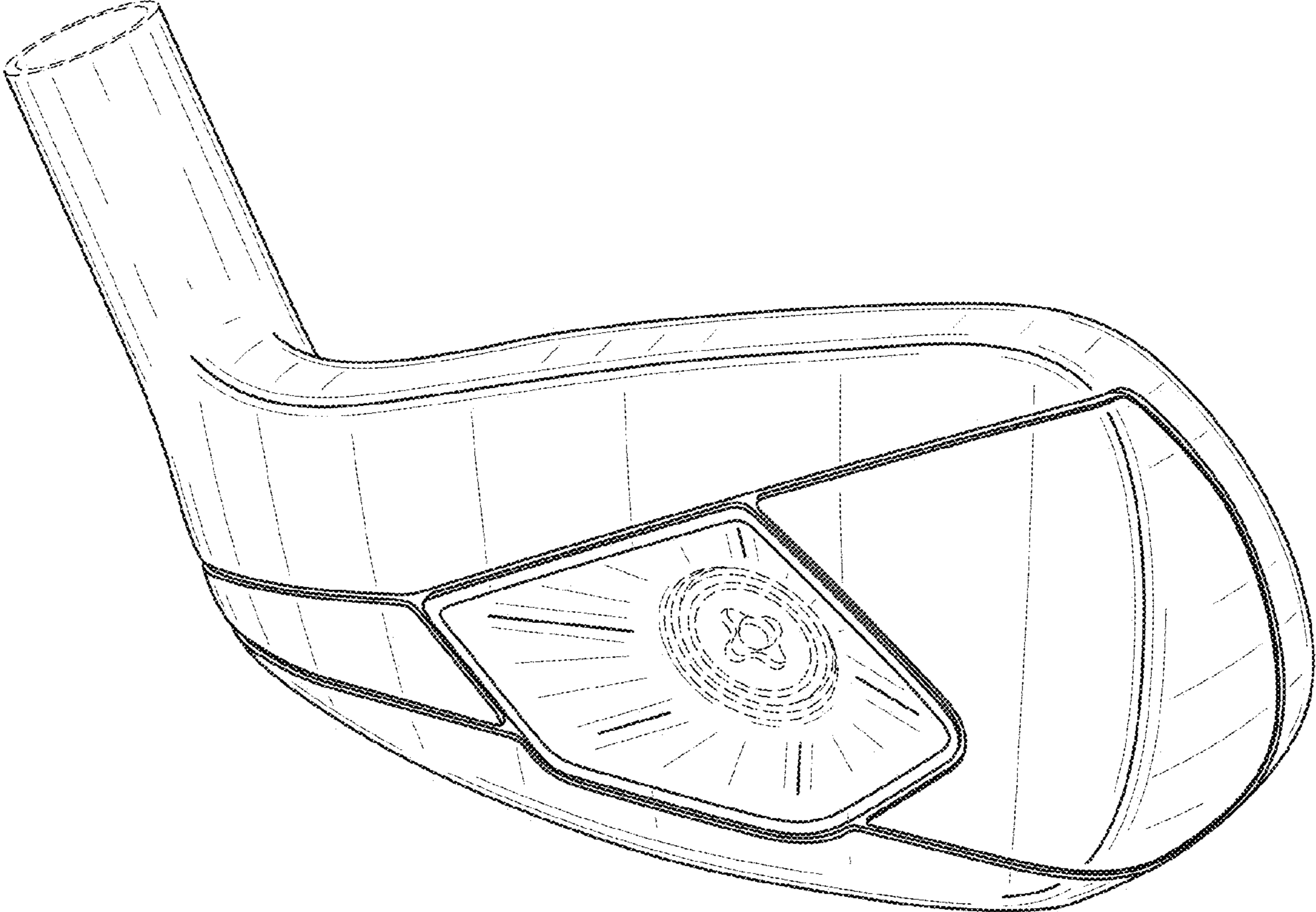

FIG. 1

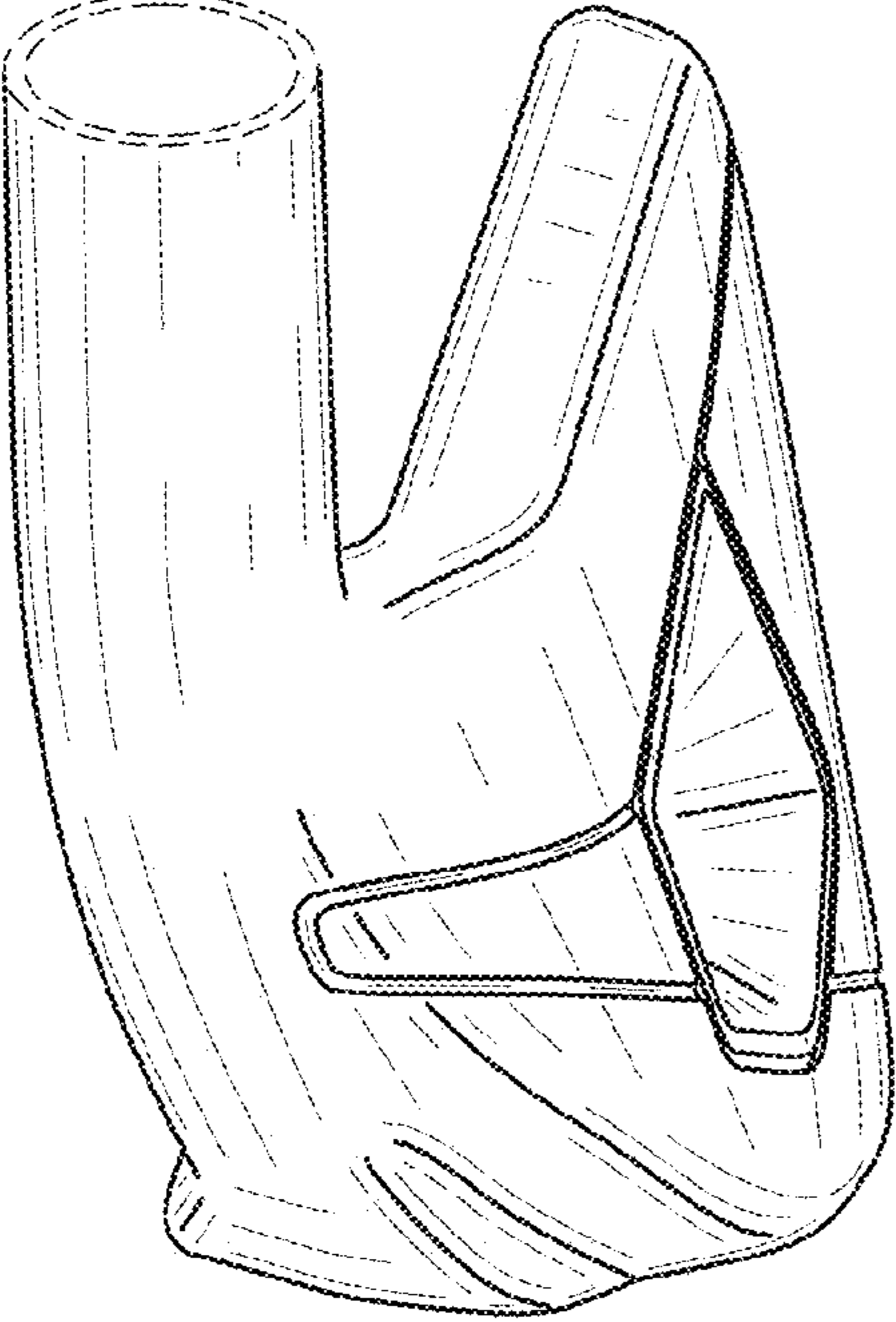

FIG. 2

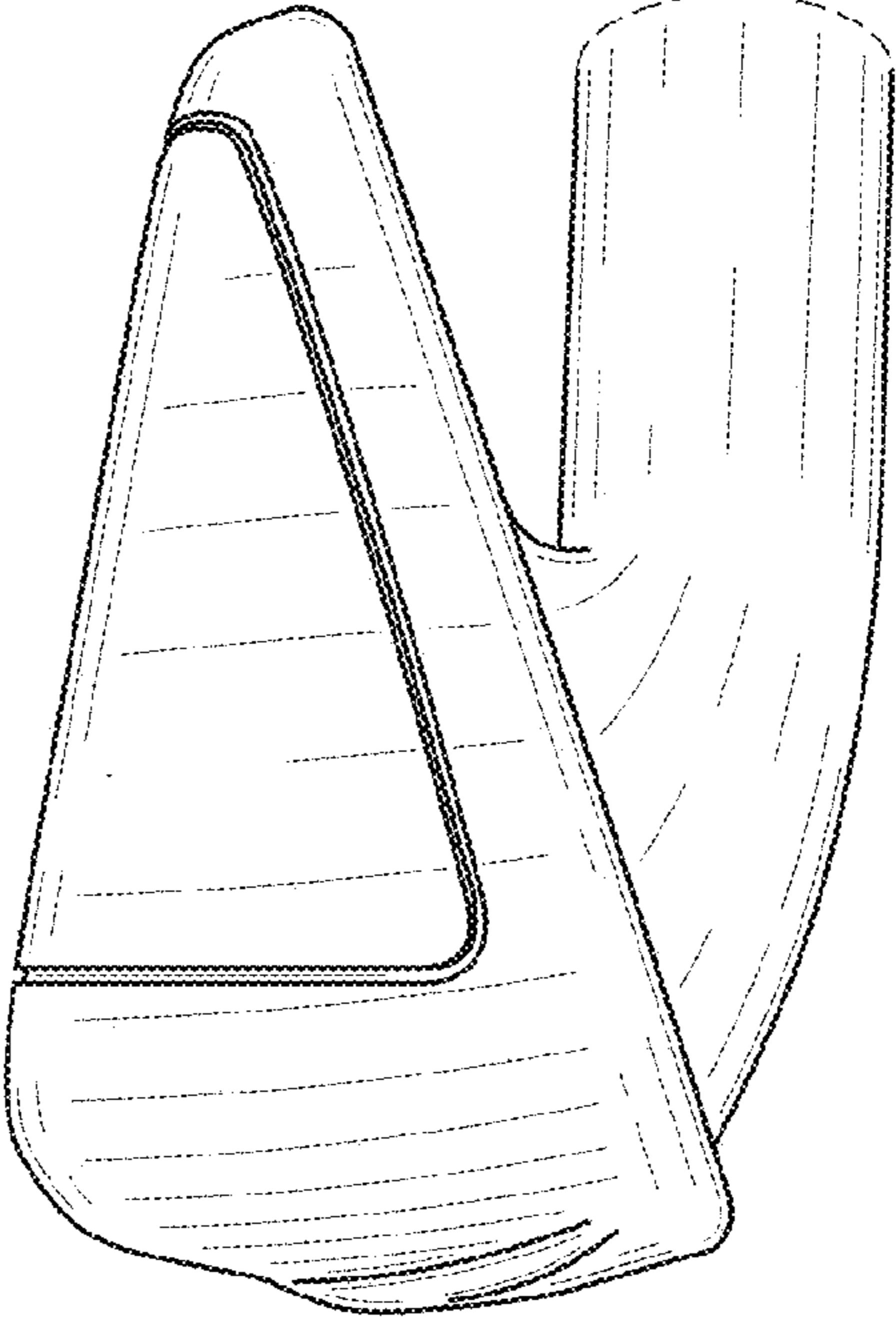

FIG. 3

FIG. 4

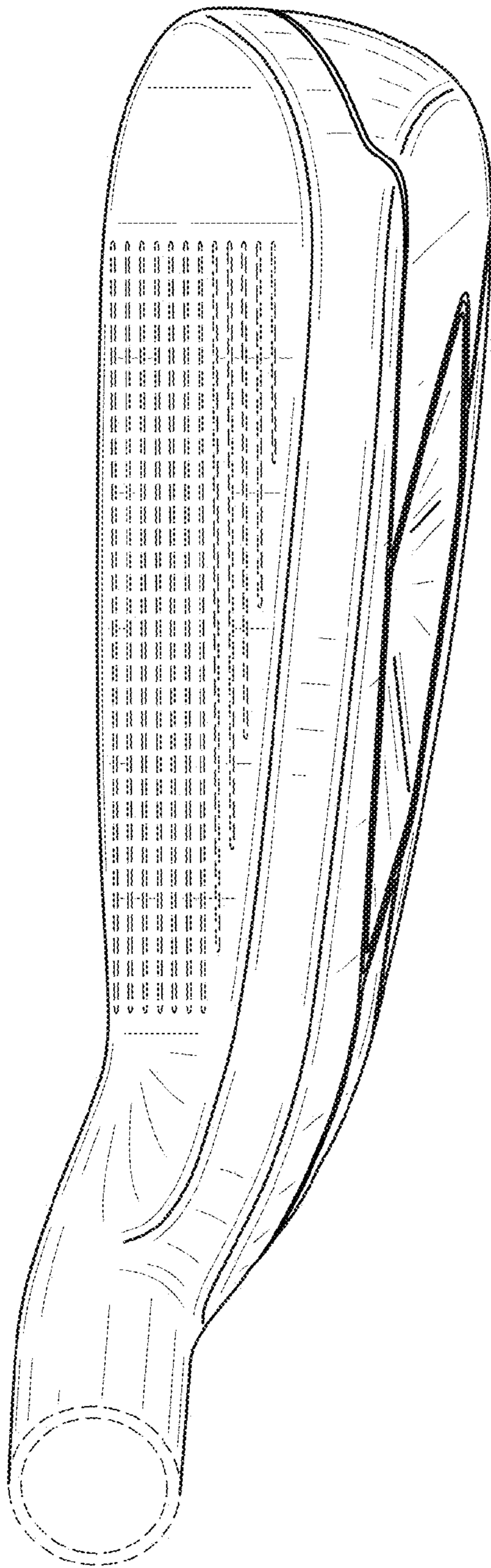
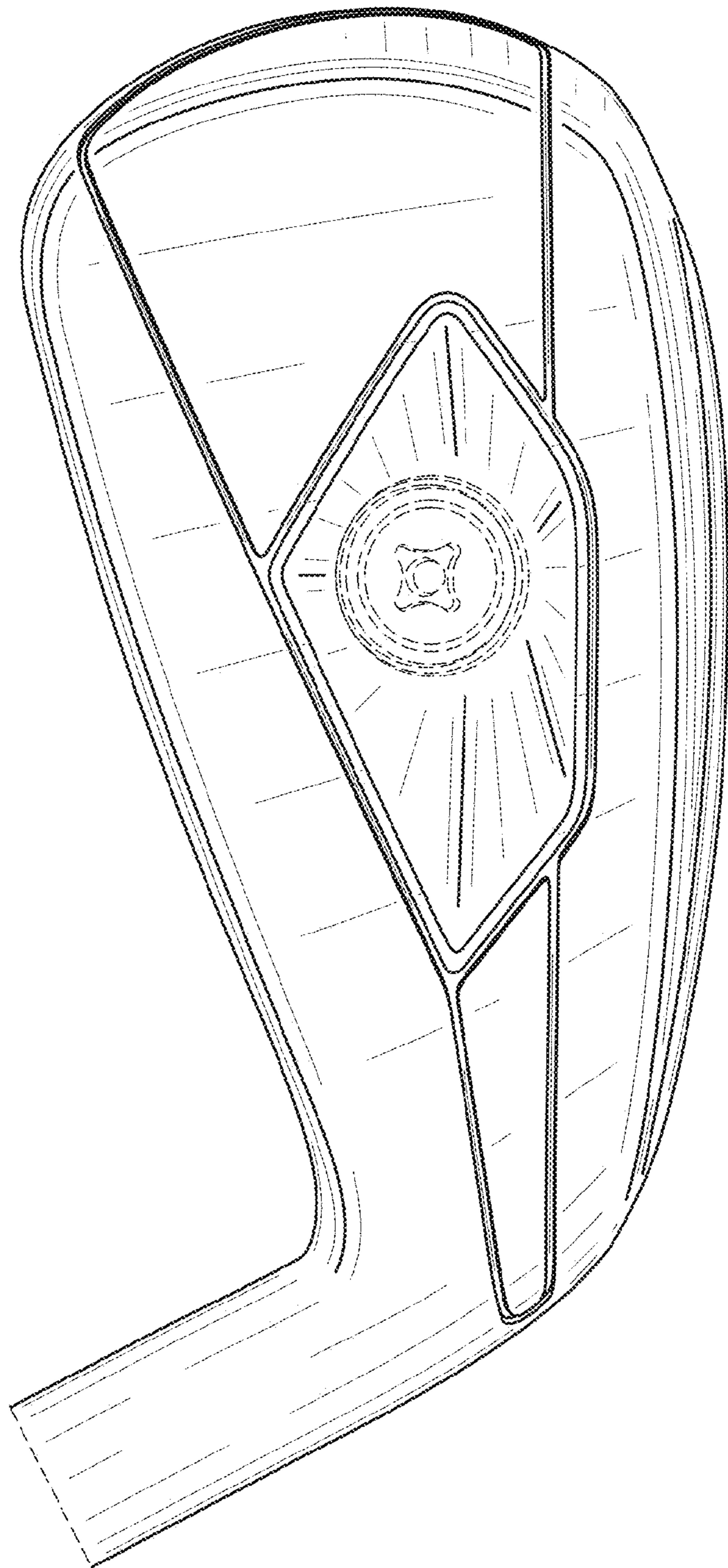

FIG. 5



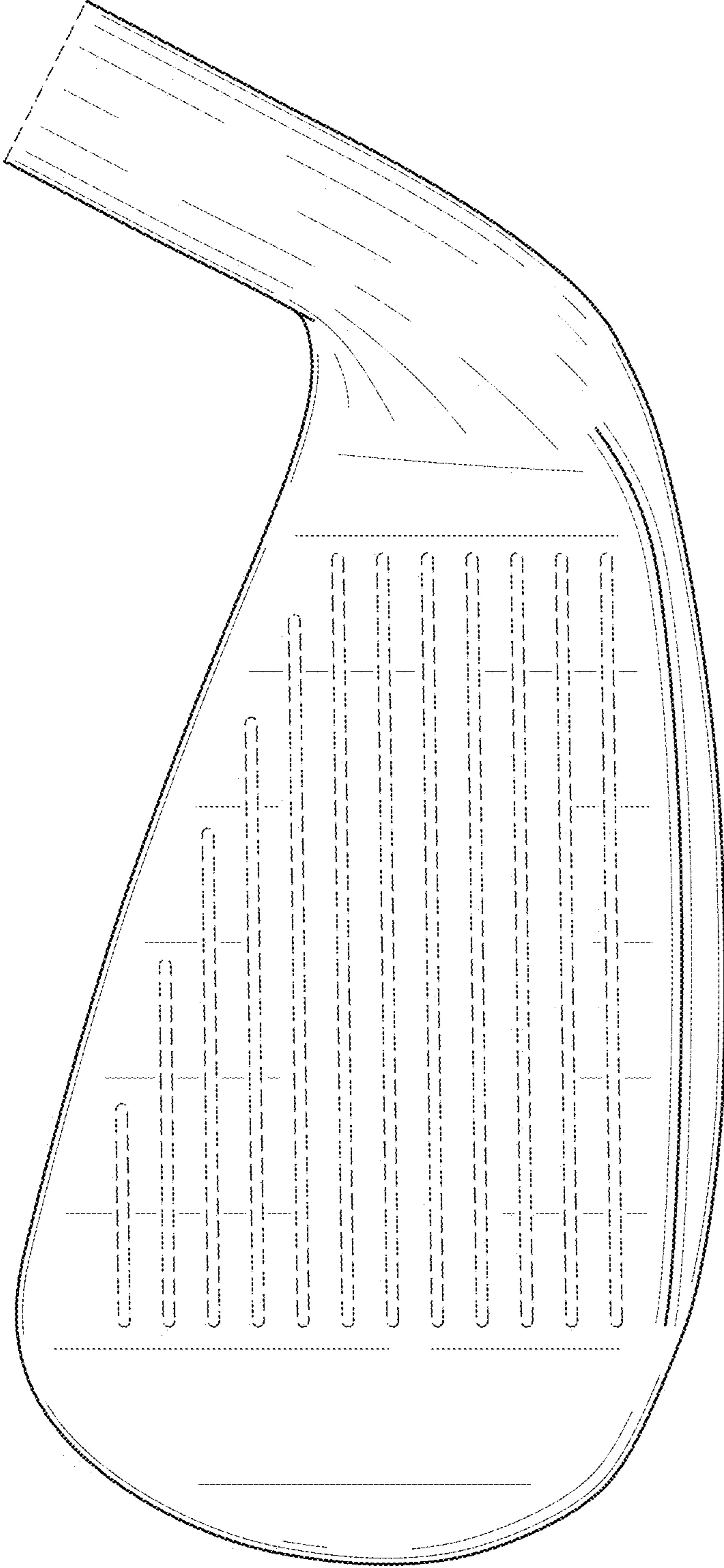

FIG. 6

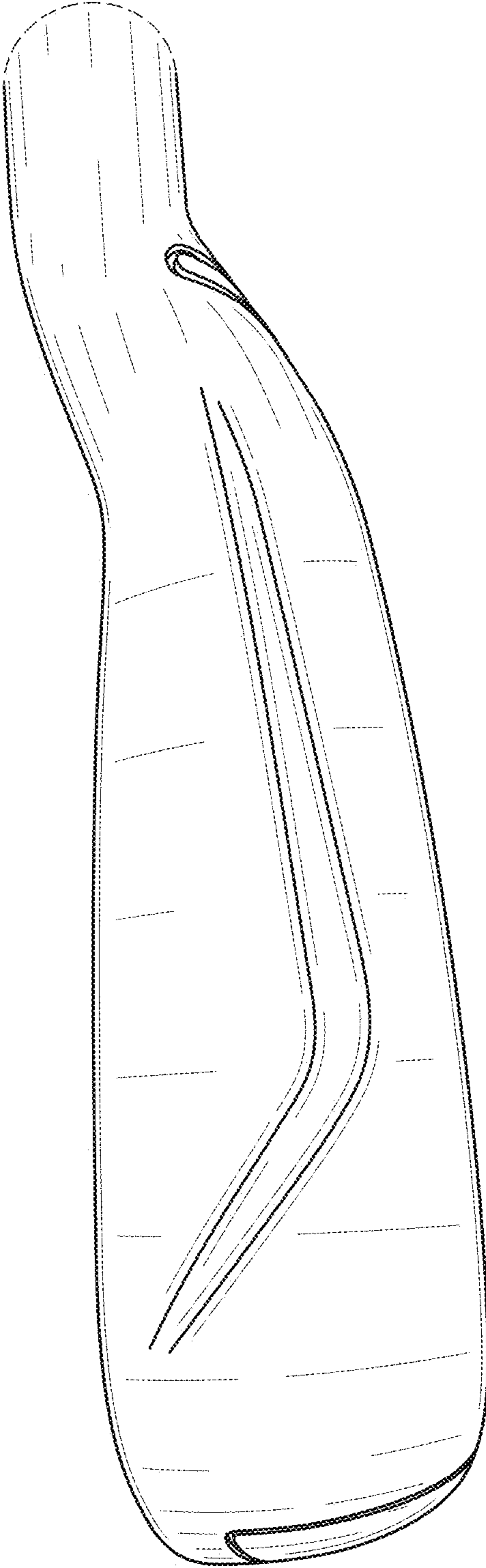

FIG. 7