



US00D963088S

(12) **United States Design Patent** (10) **Patent No.:** **US D963,088 S**
Nicolette et al. (45) **Date of Patent:** **** Sep. 6, 2022**

(54) **GOLF CLUB HEAD**

(71) Applicant: **PARSONS XTREME GOLF, LLC**,
Scottsdale, AZ (US)

(72) Inventors: **Michael R. Nicolette**, Scottsdale, AZ
(US); **Bradley D. Schweigert**, Cave
Creek, AZ (US)

(73) Assignee: **PARSONS XTREME GOLF, LLC**,
Scottsdale, AZ (US)

(**) Term: **15 Years**

(21) Appl. No.: **29/795,336**

(22) Filed: **Jun. 17, 2021**

Related U.S. Application Data

(60) Division of application No. 29/707,875, filed on Oct. 1, 2019, now Pat. No. Des. 924,346, which is a continuation-in-part of application No. 29/698,932, filed on Jul. 22, 2019, now Pat. No. Des. 923,729, and a continuation-in-part of application No. 29/698,309, filed on Jul. 16, 2019, now abandoned, which is a continuation-in-part of application No. 29/679,120, filed on Feb. 1, 2019, now abandoned, which is a continuation-in-part of application No. 29/679,120, filed on Feb. 1, 2019, now abandoned.

(51) **LOC (13) Cl.** **21-02**

(52) **U.S. Cl.**
USPC **D21/736**

(58) **Field of Classification Search**
USPC D21/736-746, 759
CPC A63B 53/00; A63B 53/04; A63B 53/007;
A63B 53/065; A63B 53/0487; A63B
60/00; A63B 60/46

See application file for complete search history.

(56) **References Cited**

U.S. PATENT DOCUMENTS

723,534	A *	3/1903	Knight	A63B 53/0466 D21/736
922,444	A	5/1909	Youds	
1,094,599	A	4/1914	Samson	
D57,980	S *	5/1921	Kraeuter	D21/741
D63,284	S	11/1923	Challis	
RE19,178	E	5/1934	Spiker	
4,043,562	A	8/1977	Shillington	
D248,783	S	8/1978	Long	
4,340,230	A	7/1982	Churchward	
D281,092	S	10/1985	Mills	
4,754,977	A	7/1988	Sahm	
4,869,507	A	9/1989	Sahm	
4,964,641	A	10/1990	Miesch et al.	
D313,451	S	1/1991	Shearer	
D335,317	S	5/1993	Shearer	
D335,692	S	5/1993	Antonious	
D336,757	S	6/1993	Antonious	
5,275,412	A	1/1994	Innes	
D350,582	S	9/1994	Miansian et al.	
5,390,919	A	2/1995	Stubbs et al.	
D356,131	S	3/1995	Trimble	
D359,330	S	6/1995	Channell	
D360,444	S	7/1995	Takahashi et al.	
5,429,366	A	7/1995	McCabe	
D363,101	S	10/1995	Sturm	
D364,665	S	11/1995	Goodrich	
D365,864	S	1/1996	Sturm	
5,489,097	A	2/1996	Simmons	
D368,751	S	4/1996	Rife	
D369,393	S	4/1996	Takahashi et al.	
5,571,053	A	11/1996	Lane	
D378,688	S	4/1997	Cameron	
D380,514	S	7/1997	Markley	
D381,382	S	7/1997	Fenton, Jr.	
D385,609	S	10/1997	Cameron	
5,683,307	A	11/1997	Rife	
D388,143	S	12/1997	Huan-Chiang	
D389,207	S	1/1998	Cameron	
D396,083	S *	7/1998	Sheets	D21/742
D398,685	S	9/1998	Masuda	
5,807,190	A	9/1998	Krumme et al.	
D399,274	S	10/1998	Bradford	
D399,290	S	10/1998	Sizemore, Jr.	
D399,911	S	10/1998	Nicolette et al.	
D400,610	S *	11/1998	Cameron	D21/742
5,839,974	A	11/1998	McAllister	
D405,836	S	2/1999	Nicolette et al.	
D409,701	S	5/1999	Ashcraft et al.	

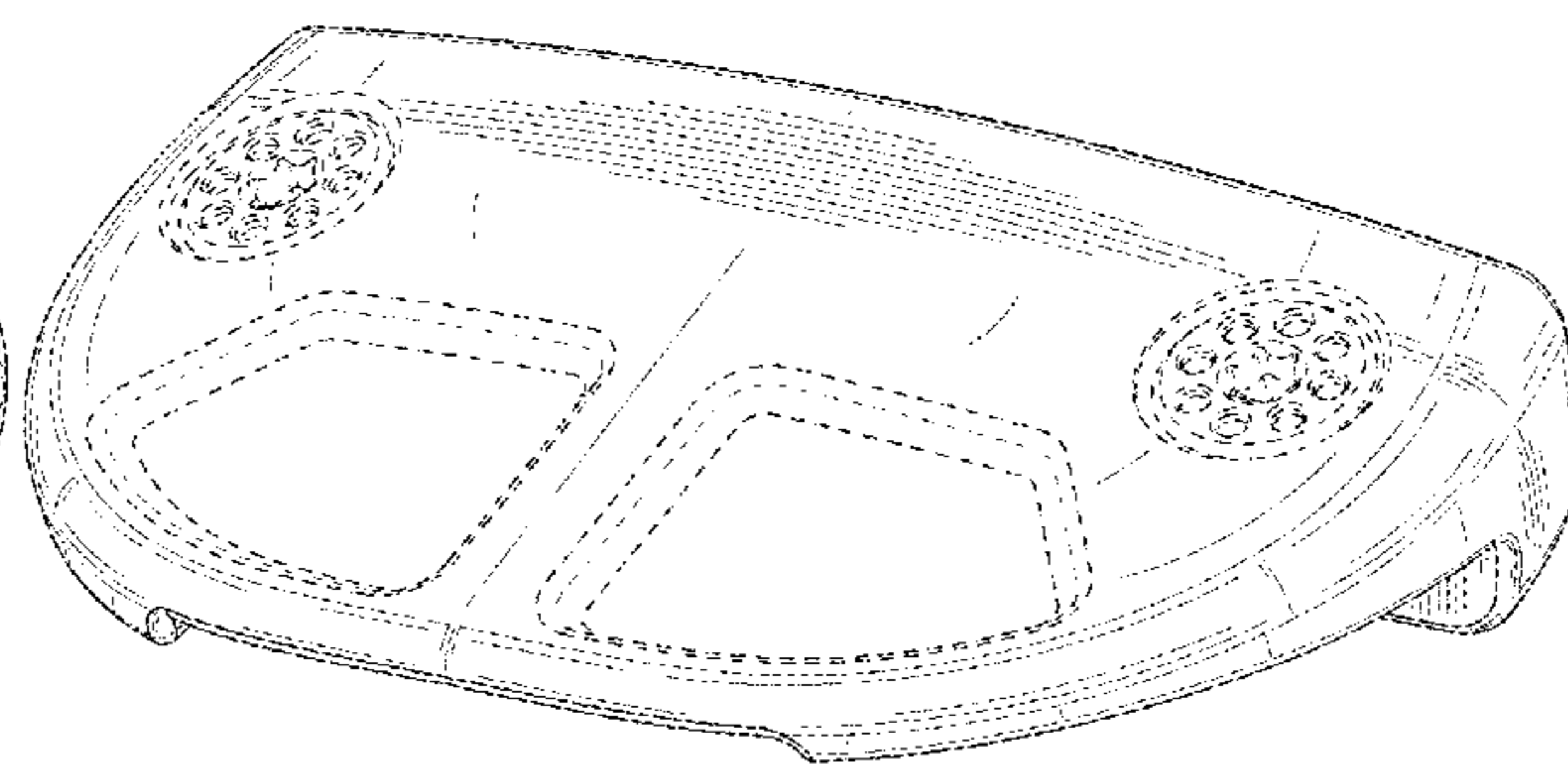
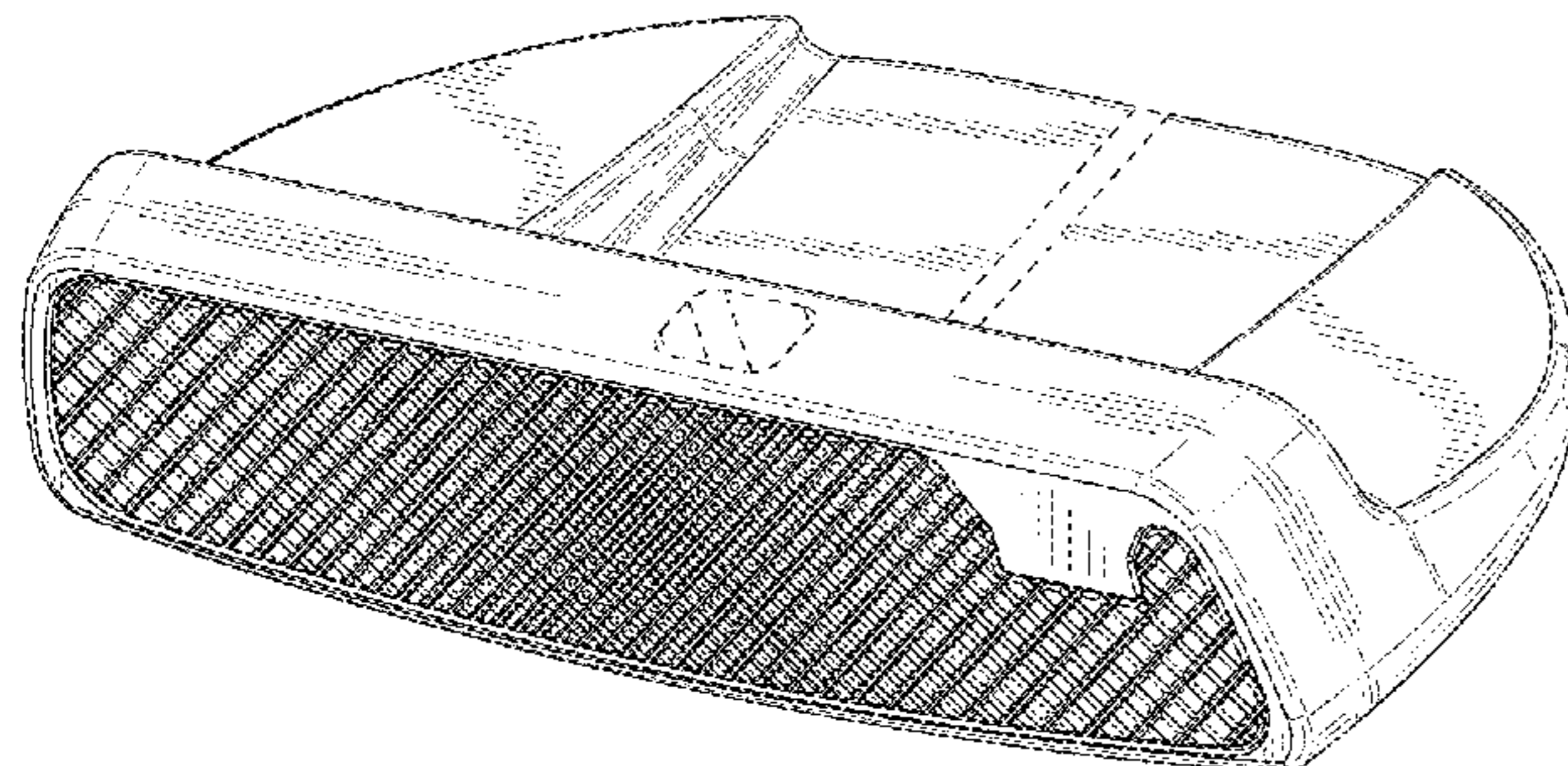

8,608,590 B2 12/2013 Hackel et al.
 D699,308 S 2/2014 Rollinson
 8,696,492 B1 4/2014 Hocknell et al.
 D704,782 S 5/2014 Rollinson
 8,721,472 B2 5/2014 Kuan et al.
 8,790,193 B2 7/2014 Serrano et al.
 D711,483 S 8/2014 Wong
 D715,388 S 10/2014 Serrano et al.
 D720,022 S * 12/2014 Rollinson D21/736
 D720,023 S * 12/2014 Rollinson D21/736
 D720,411 S * 12/2014 Rollinson D21/743
 D720,412 S * 12/2014 Rollinson D21/743
 8,900,064 B2 12/2014 Franklin
 D722,350 S 2/2015 Schweigert
 D722,351 S 2/2015 Parsons et al.
 D722,352 S 2/2015 Nicolette et al.
 D723,120 S 2/2015 Nicolette
 D724,164 S 3/2015 Schweigert et al.
 D725,208 S * 3/2015 Schweigert D21/743
 D726,265 S 4/2015 Nicolette
 D726,270 S 4/2015 Rollinson
 D726,846 S * 4/2015 Schweigert D21/743
 D730,462 S 5/2015 Becktor et al.
 D732,122 S 6/2015 Becktor
 D732,618 S 6/2015 Becktor et al.
 D733,234 S 6/2015 Nicolette
 D735,283 S 7/2015 Solheim et al.
 9,108,088 B2 8/2015 Serrano et al.
 D738,447 S * 9/2015 Schweigert D21/736
 D738,449 S 9/2015 Schweigert
 D739,487 S 9/2015 Schweigert
 9,144,717 B2 9/2015 Franklin et al.
 D741,426 S 10/2015 Schweigert
 D746,926 S 1/2016 Parsons et al.
 D748,213 S 1/2016 Parsons et al.
 D748,215 S 1/2016 Parsons et al.
 9,233,283 B2 1/2016 Schweigert
 9,265,996 B1 2/2016 Abbott et al.
 D752,697 S 3/2016 Claveran
 D753,252 S 4/2016 Schweigert
 D759,173 S * 6/2016 Rollinson D21/743
 D762,274 S * 7/2016 Cardani D21/759
 D763,382 S * 8/2016 Cardani D21/759
 D765,198 S * 8/2016 Cardani D21/759
 9,440,124 B2 9/2016 Parsons et al.
 D768,247 S * 10/2016 Rollinson D21/744
 9,498,685 B2 11/2016 Abbott et al.
 D779,006 S * 2/2017 Abbott D21/744
 9,566,484 B1 2/2017 Abbott et al.
 D783,745 S 4/2017 Chen
 D791,254 S 7/2017 Ramsauer
 D791,891 S 7/2017 Davis
 D794,146 S 8/2017 Davis
 D796,603 S * 9/2017 Serrano D21/744
 D798,975 S 10/2017 Becktor
 D798,976 S 10/2017 Becktor
 D798,977 S 10/2017 Becktor
 D798,978 S 10/2017 Becktor
 D798,979 S 10/2017 Becktor
 D798,980 S 10/2017 Becktor
 D798,981 S 10/2017 Becktor et al.
 D799,619 S 10/2017 Becktor et al.
 D802,073 S * 11/2017 Toulon D21/759
 D809,616 S 2/2018 Toulon et al.
 D812,163 S * 3/2018 Kroloff D21/736
 9,987,530 B2 6/2018 Jertson et al.
 D824,462 S 7/2018 Bruschi et al.
 D826,353 S * 8/2018 Cameron D21/736
 D827,742 S 9/2018 Weaver
 D835,217 S 12/2018 Nicolette
 D837,911 S 1/2019 Bruschi et al.
 10,173,105 B2 * 1/2019 Myers A63B 53/0487
 D839,977 S 2/2019 Rollinson et al.
 D844,085 S 3/2019 Nicolette
 D844,723 S 4/2019 Nicolette
 D859,545 S 9/2019 Long et al.
 D860,353 S * 9/2019 Rollinson D21/743
 D861,091 S 9/2019 Glorioso et al.
 10,441,858 B2 * 10/2019 Schweigert A63B 53/065

10,493,331 B2 * 12/2019 Kroloff A63B 53/0433
 D872,816 S * 1/2020 Parsons D21/736
 D873,358 S * 1/2020 Lee D21/744
 D877,831 S 3/2020 Cameron
 D879,223 S * 3/2020 Serrano D21/742
 D879,895 S * 3/2020 Schweigert D21/759
 10,646,758 B2 * 5/2020 Schweigert A63B 60/02
 D892,243 S 8/2020 Rollinson et al.
 D892,955 S * 8/2020 Clarke D21/744
 D893,655 S 8/2020 Schweigert et al.
 D895,037 S 9/2020 Clarke et al.
 D895,747 S * 9/2020 Rollinson D21/743
 D896,328 S 9/2020 Clarke et al.
 D896,903 S * 9/2020 Schweigert D21/743
 D898,846 S * 10/2020 Clarke D21/743
 D898,847 S * 10/2020 Clarke D21/743
 D906,453 S 12/2020 Agrella et al.
 D906,457 S 12/2020 Lambeth et al.
 D907,146 S 1/2021 Cyrulik et al.
 D907,147 S 1/2021 Agrella et al.
 D907,730 S 1/2021 Rollinson et al.
 D923,729 S * 6/2021 Nicolette D21/736
 D924,346 S * 7/2021 Nicolette D21/736
 2004/0138003 A1 7/2004 Grace
 2004/0180730 A1 9/2004 Franklin et al.
 2006/0052178 A1 3/2006 Franklin et al.
 2006/0094522 A1 5/2006 Tang et al.
 2006/0223649 A1 10/2006 Rife
 2007/0129163 A1 6/2007 Solari
 2007/0135229 A1 6/2007 Lo et al.
 2007/0142122 A1 6/2007 Bonneau
 2007/0207875 A1 9/2007 Kuan et al.
 2007/0238548 A1 10/2007 Johnson
 2008/0139333 A1 6/2008 Klein
 2008/0146372 A1 6/2008 John
 2008/0176672 A1 7/2008 Roach et al.
 2009/0029800 A1 1/2009 Jones et al.
 2010/0255922 A1 10/2010 Lueders
 2011/0165959 A1 7/2011 Klein
 2013/0165256 A1 6/2013 Stevenson
 2013/0210537 A1 8/2013 Ainscough et al.
 2015/0057100 A1 2/2015 Serrano et al.
 2015/0258390 A1 9/2015 DeFrancesco, Jr.
 2015/0306477 A1 10/2015 Parsons et al.
 2016/0016050 A1 1/2016 Rife
 2016/0346649 A1 12/2016 Jertson et al.
 2018/0001163 A1 1/2018 Becktor et al.
 2018/0311545 A1 11/2018 Lambeth et al.
 2019/0175995 A1 6/2019 Kroloff et al.
 2019/0175996 A1 6/2019 Kroloff et al.
 2020/0061421 A1 2/2020 Kroloff et al.

FOREIGN PATENT DOCUMENTS

JP 2004223184 A 8/2004
 JP 2005160691 A 6/2005
 KR 200377377 Y1 3/2005
 KR 200403045 Y1 12/2005
 KR 20100065481 A 6/2010
 KR 101773069 B1 8/2017

OTHER PUBLICATIONS

Pxg putter google search; google.com; Jul. 12, 2022.*
 pxg.com; Jul. 12, 2022.*
 Plugged In Golf (2015 Bettinardi Putters Review) [online]. Mar. 3, 2015, [retrieve Nov. 25, 2019].
 TourSpecGolf (Gold's Factory Multi Weighted Custom Putter), Published Nov. 20, 2010 [http://blog.tourSpecgolf.com/golds-factory-multi-weighted-custom-putter/], Retrieved May 17, 2020.
 U.S. Appl. No. 29/523,587, Schweigert, "Golf Club Head," filed Apr. 10, 2015.

* cited by examiner

Primary Examiner — Mitchell I. Siegel

(57)

CLAIM

The ornamental design for a golf club head, as shown and described.

DESCRIPTION

FIG. 1 is a top perspective view of a golf club head;
FIG. 2 is a bottom perspective view of the golf club head of FIG. 1;
FIG. 3 is a front elevational view of the golf club head of FIG. 1;
FIG. 4 is a rear elevational view of the golf club head of FIG. 1;
FIG. 5 is a top view of the golf club head of FIG. 1;
FIG. 6 is a bottom view of the golf club head of FIG. 1;
FIG. 7 is a left side view of the golf club head of FIG. 1; and,
FIG. 8 is a right side view of the golf club head of FIG. 1.
The broken lines shown on the drawings form no part of the claimed design.

1 Claim, 4 Drawing Sheets

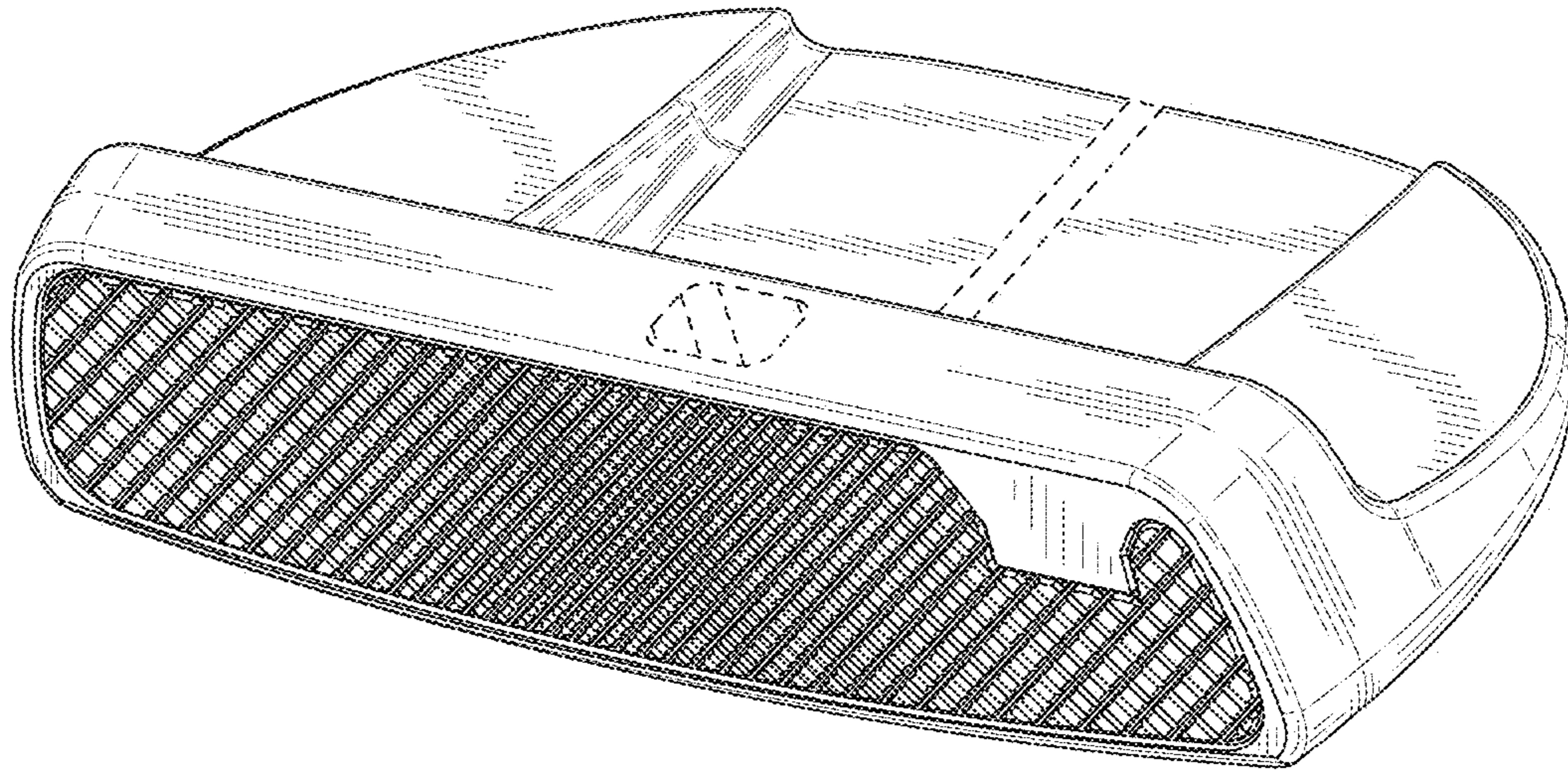

FIG. 1

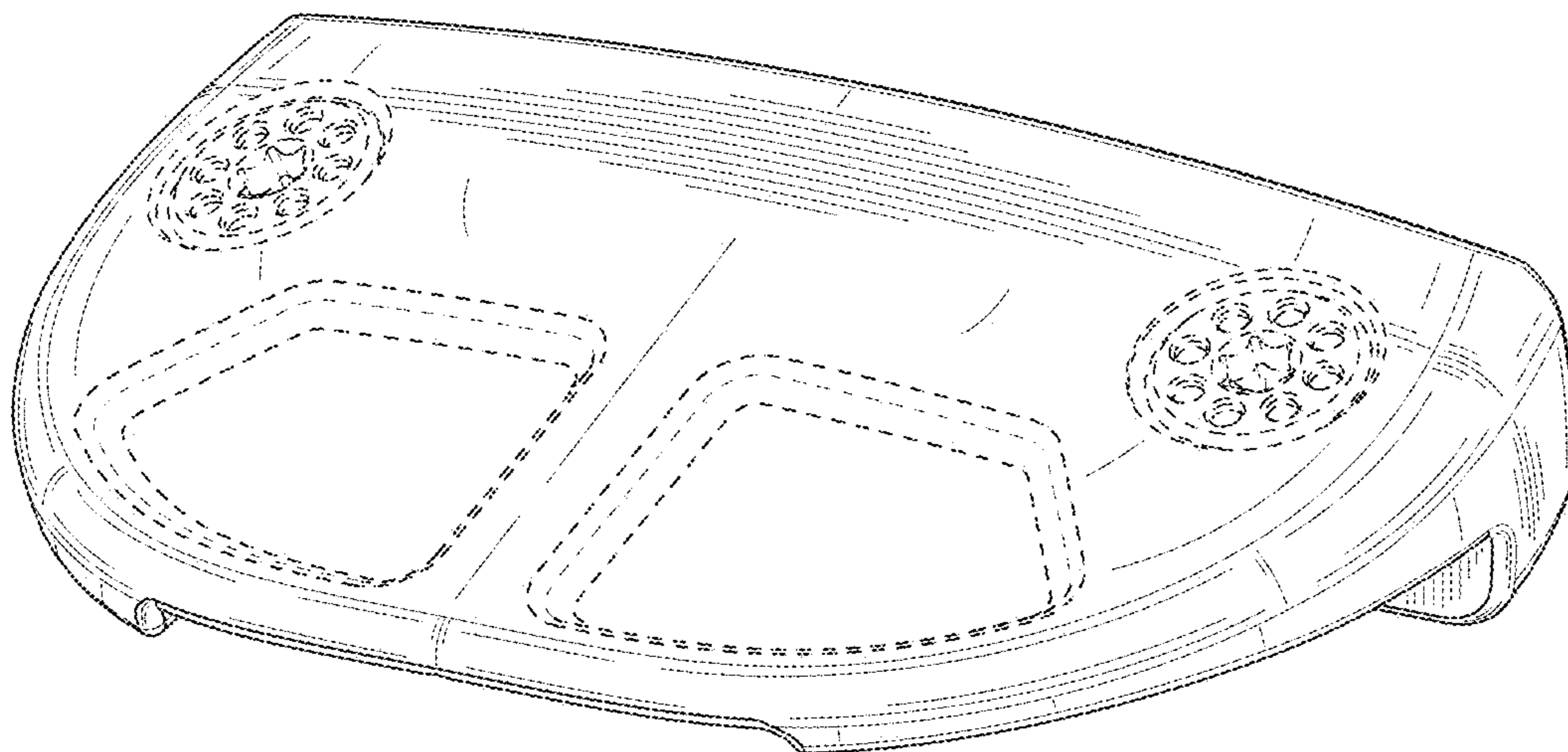

FIG. 2

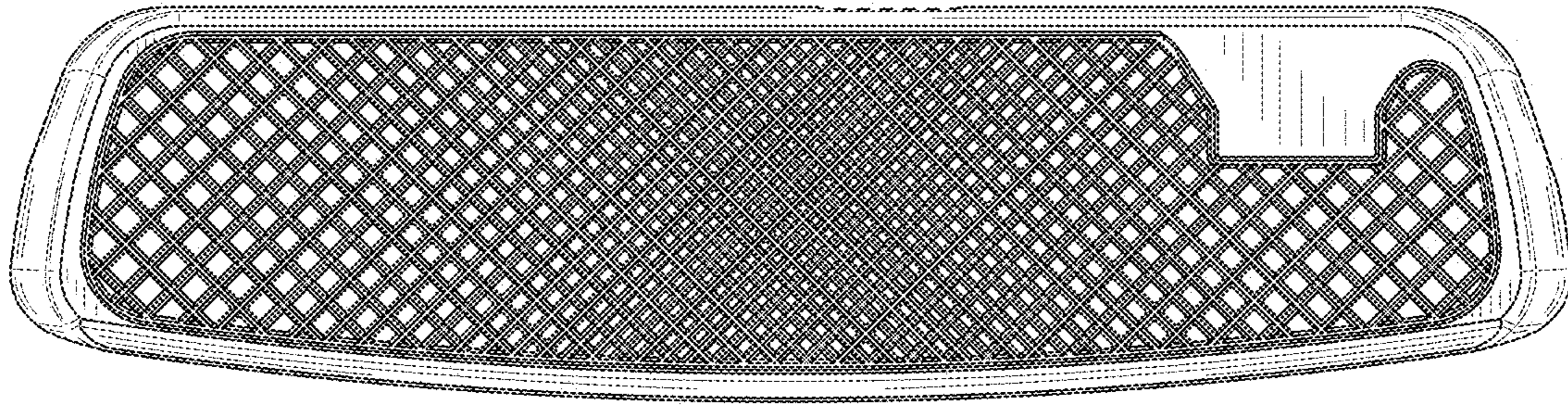

FIG. 3

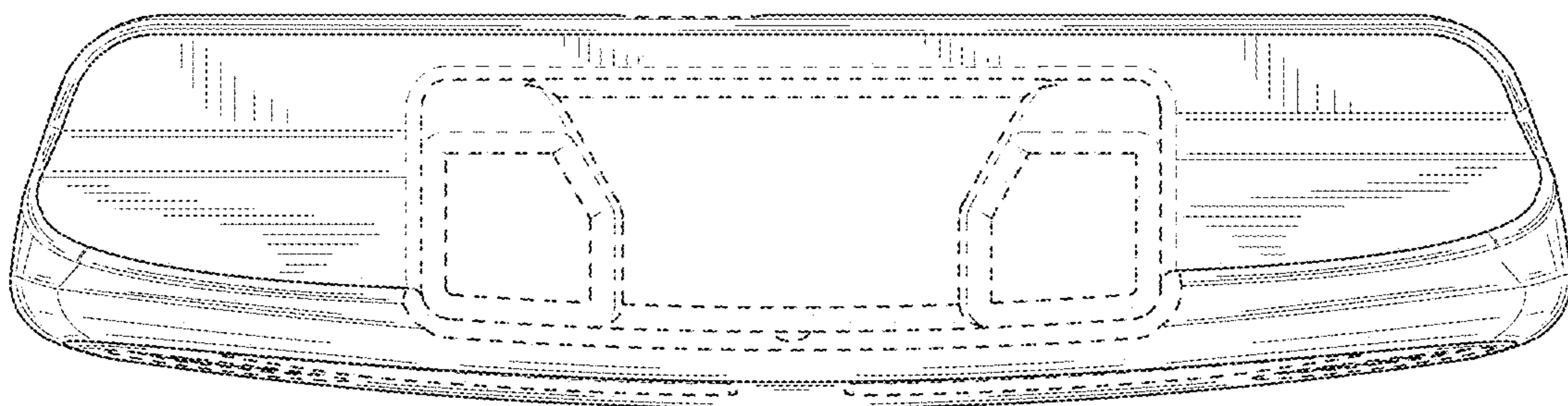

FIG. 4

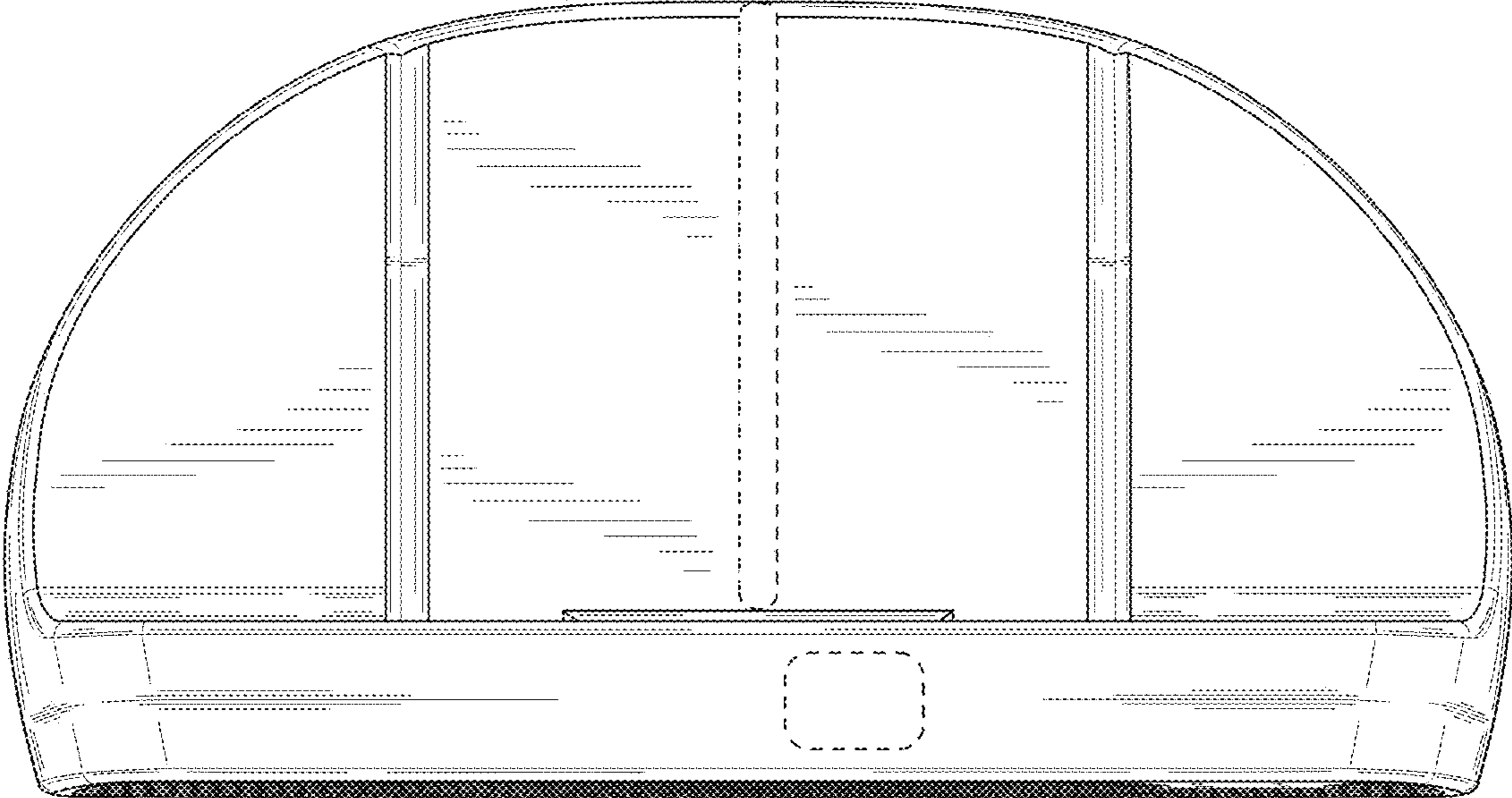

FIG. 5

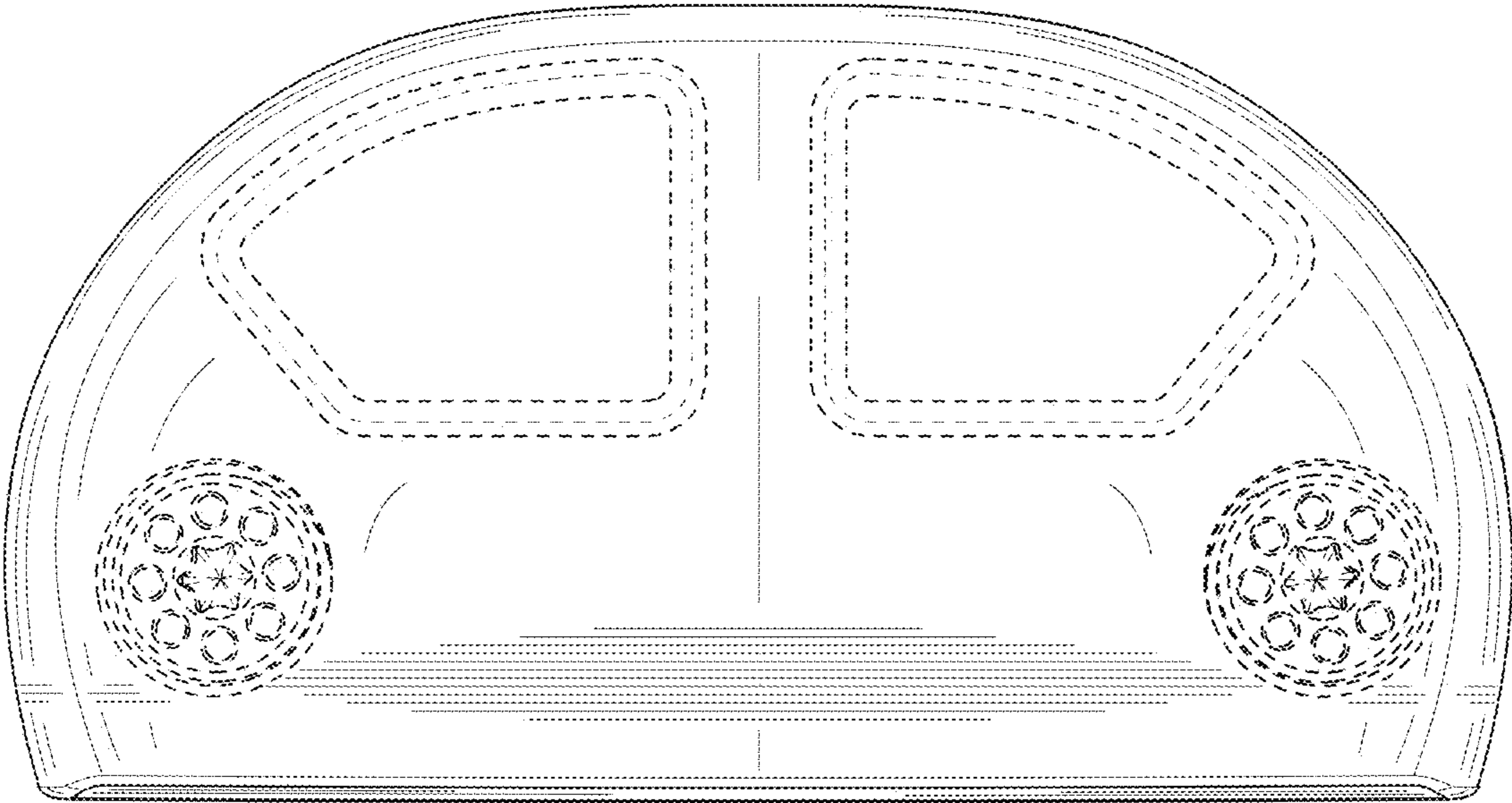

FIG. 6

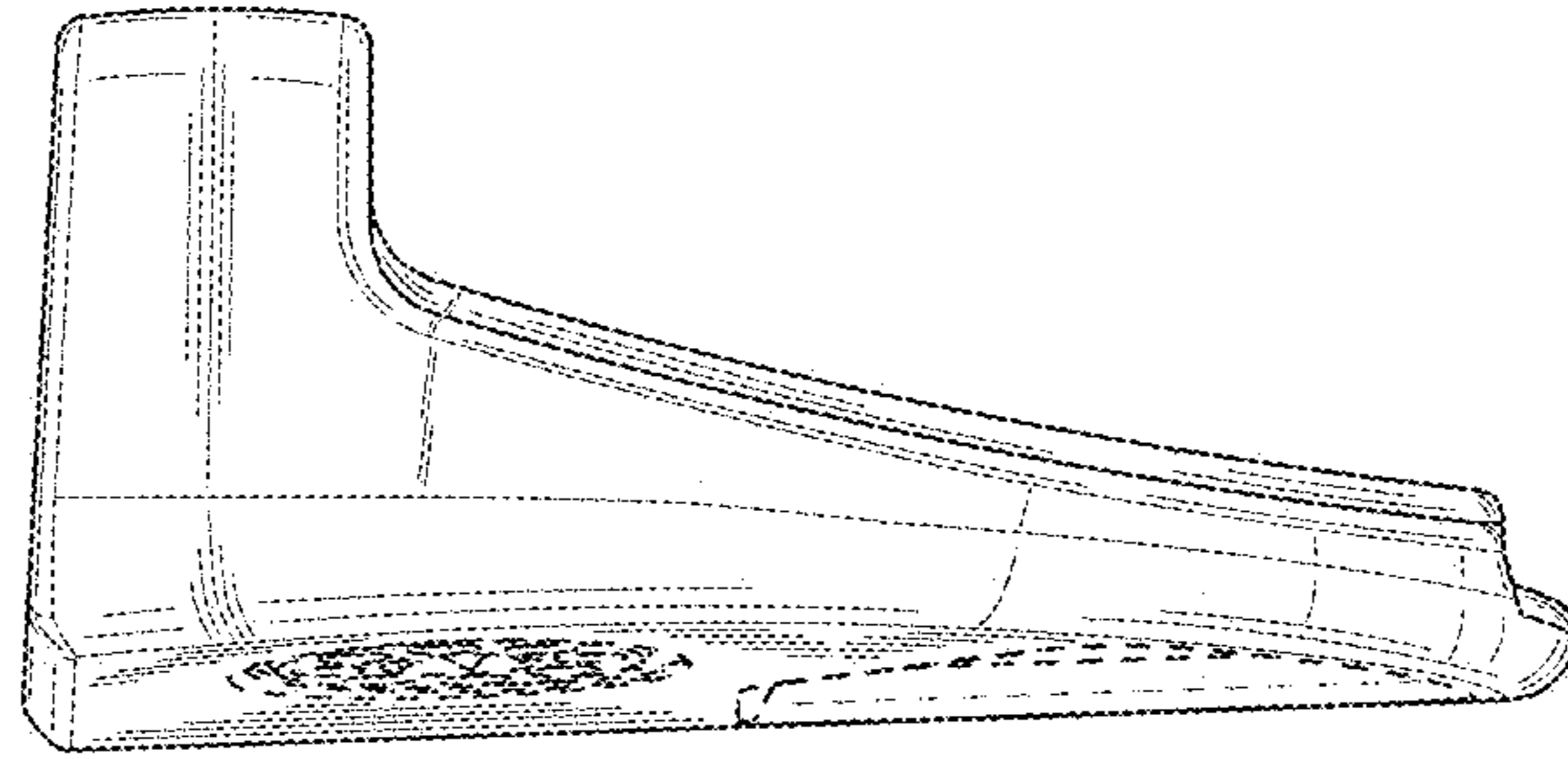

FIG. 7

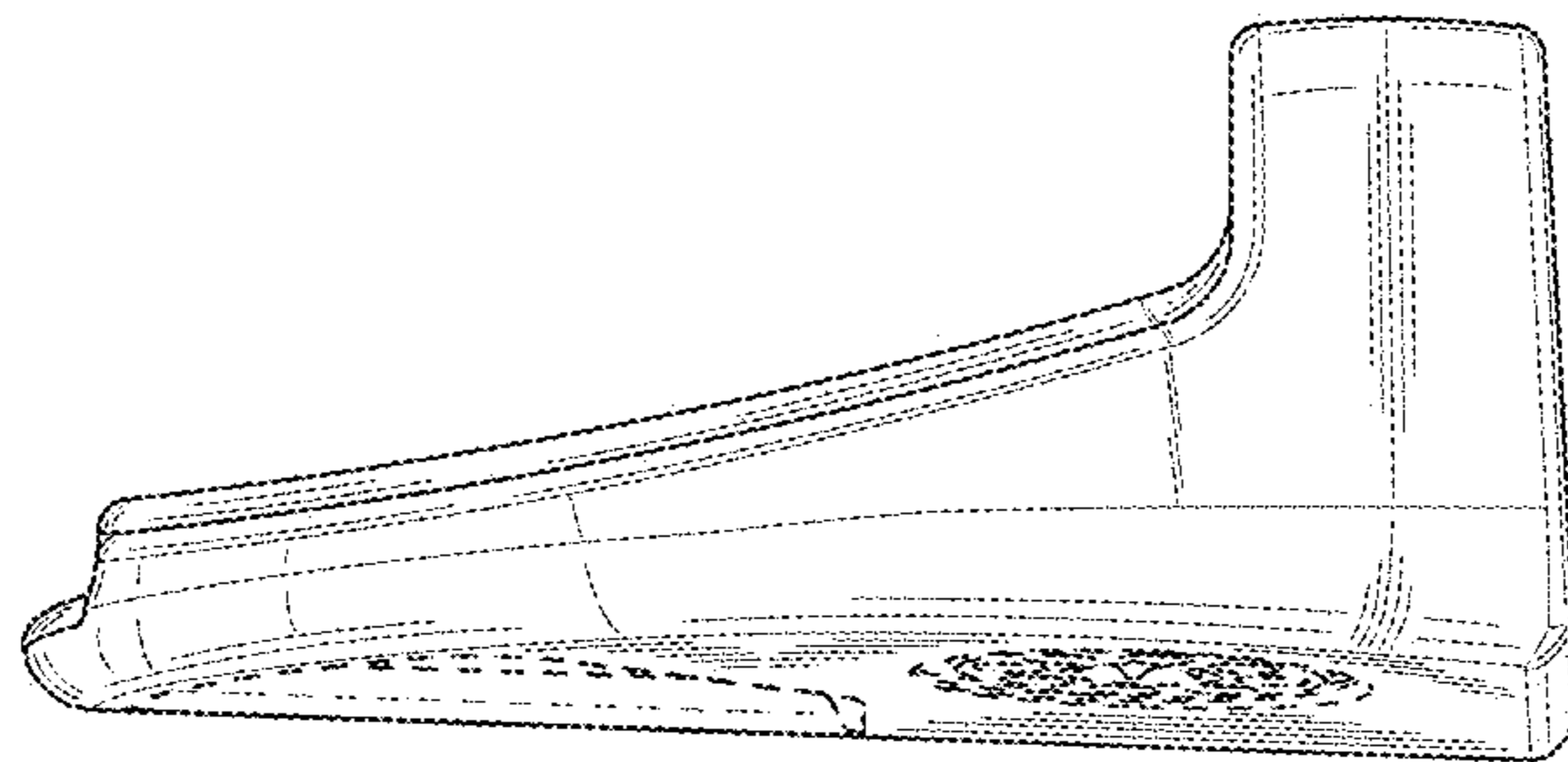

FIG. 8