



US00D963077S

(12) **United States Design Patent**
Stearnes

(10) **Patent No.:** **US D963,077 S**
(45) **Date of Patent:** **** Sep. 6, 2022**

(54) **SET OF EXERCISE WEIGHTS**

- (71) Applicant: **Andre Francois Stearnes**, LaMarque, TX (US)
- (72) Inventor: **Andre Francois Stearnes**, LaMarque, TX (US)
- (**) Term: **15 Years**
- (21) Appl. No.: **29/692,524**
- (22) Filed: **May 24, 2019**
- (51) **LOC (13) Cl.** **21-02**
- (52) **U.S. Cl.**
USPC **D21/680**
- (58) **Field of Classification Search**
USPC D21/662, 680, 681, 682, 683, 694, 688,
D21/801; 482/108, 106, 107
(Continued)

(56) **References Cited**

U.S. PATENT DOCUMENTS

- 4,103,887 A * 8/1978 Shoofler A63B 21/0602
482/106
- 4,369,968 A * 1/1983 Price A63B 21/0724
482/106

(Continued)

Primary Examiner — Ryan Harvey

(74) *Attorney, Agent, or Firm* — Karen B. Tripp

(57) **CLAIM**

The ornamental design for a set of exercise weights, as shown and described.

DESCRIPTION

FIG. 1 is a top, right, front perspective view of a first exercise weight according to the present invention;
 FIG. 2 is a front view of the exercise weight of FIG. 1, the back view is a mirror image of the front view;
 FIG. 3 is a left side view of the exercise weight of FIG. 1;

FIG. 4 is a right side view of the exercise weight of FIG. 1;
 FIG. 5 is a top view of the exercise weight of FIG. 1;
 FIG. 6 is a bottom view of the exercise weight of FIG. 1;
 FIG. 7 is a section view of the exercise weight of FIG. 1, taken from FIG. 2;
 FIG. 8 is top, right, front perspective view of a second exercise weight according to the present invention;
 FIG. 9 is a front view of the exercise weight of FIG. 8, the back view is a mirror image of the front view;
 FIG. 10 is a left side view of the exercise weight of FIG. 8;
 FIG. 11 is a right side view of the exercise weight of FIG. 8;
 FIG. 12 is a top view of the exercise weight of FIG. 8; the bottom view is a mirror image of the top view;
 FIG. 13 is a top, right, front perspective view of a third exercise weight according to the present invention;
 FIG. 14 is a front view of the exercise weight of FIG. 13, the back view is a mirror image of the front view;
 FIG. 15 is a left side view of the exercise weight of FIG. 13; the right side view is a mirror image of the front view;
 FIG. 16 is a top view of the exercise weight of FIG. 13;
 FIG. 17 is a bottom view of the exercise weight of FIG. 13;
 FIG. 18 is a section view of the exercise weight of FIG. 13, taken from FIG. 14;
 FIG. 19 is a top, right, front perspective view of a fourth exercise weight according to the present invention;
 FIG. 20 is a front view of the exercise weight of FIG. 19, the back view is a mirror image of the front view;
 FIG. 21 is a left side view of the exercise weight of FIG. 19; the right side view is a mirror image of the front view;
 FIG. 22 is a top view of the exercise weight of FIG. 19;
 FIG. 23 is a bottom view of the exercise weight of FIG. 19;
 FIG. 24 is a section view of the exercise weight of FIG. 19, taken from FIG. 20;
 FIG. 25 is a top, right, front perspective view of a fifth exercise weight according to the present invention;
 FIG. 26 is a front view of the exercise weight of FIG. 25, the back view is a mirror image of the front view;
 FIG. 27 is a left side view of the exercise weight of FIG. 25; the right side view is a mirror image of the front view;
 FIG. 28 is a top view of the exercise weight of FIG. 25; the bottom view is a mirror image of the top view;
 FIG. 29 is a section view of the exercise weight of FIG. 25, taken from FIG. 26; and,

(Continued)

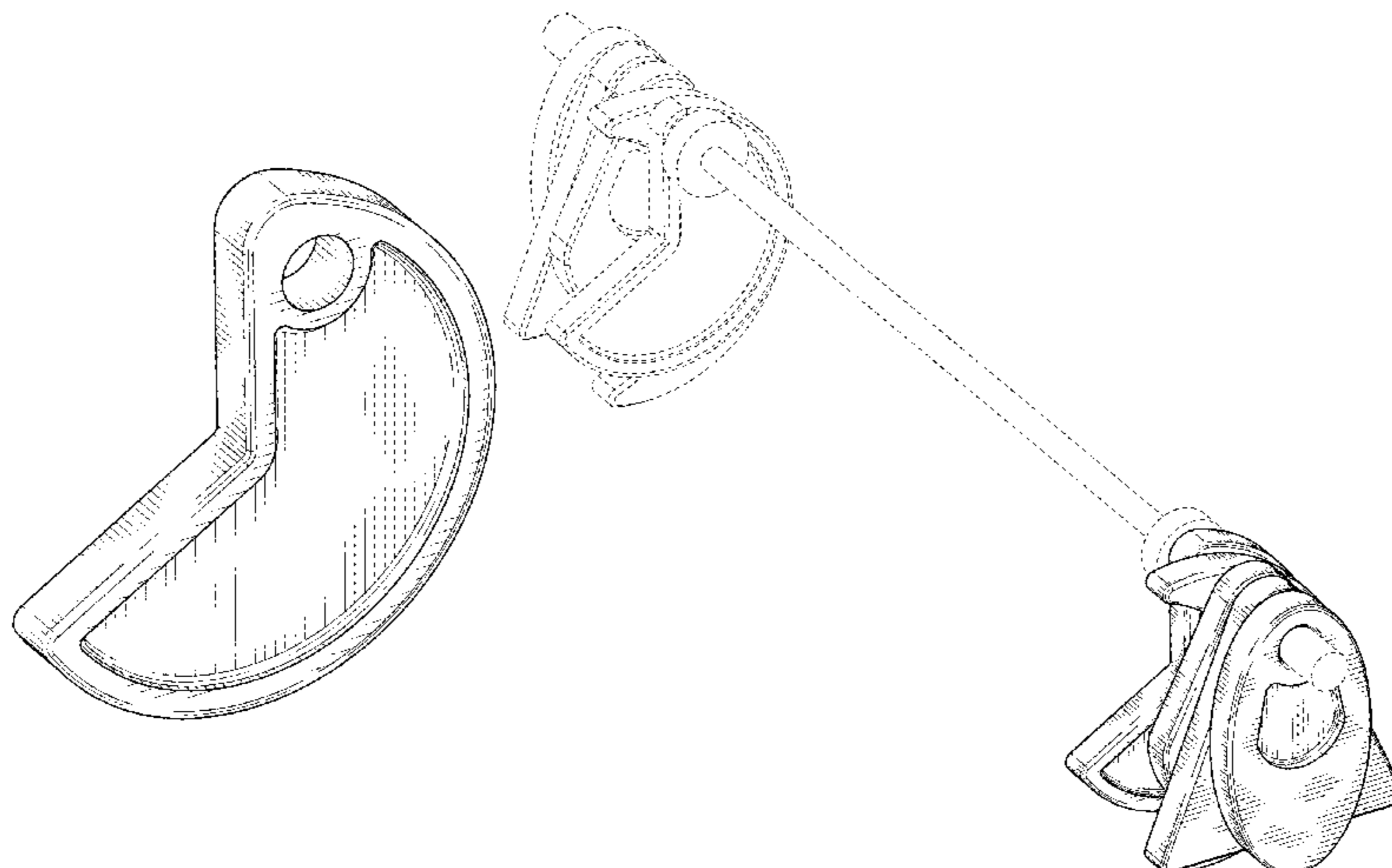

FIG. 30 is an environmental perspective view of the set of exercise weights of the invention. The broken lines, in FIG. 30, depict environment and form no part of the claim.

1 Claim, 11 Drawing Sheets

(58) **Field of Classification Search**

CPC A63B 21/075; A63B 21/0724; A63B 21/0728; A63B 21/072; A63B 21/0726; A63B 21/065; A63B 21/4007
See application file for complete search history.

(56) **References Cited**

U.S. PATENT DOCUMENTS

4,756,526 A * 7/1988 Broussard A63B 21/0724
482/93

4,880,229 A * 11/1989 Broussard A63B 21/0724
482/106
D306,332 S * 2/1990 Mayfield D21/681
5,102,124 A * 4/1992 Diodati A63B 21/0605
482/106
5,344,375 A * 9/1994 Cooper A63B 21/0728
482/106
D424,639 S * 5/2000 Rojas D21/680
D441,812 S * 5/2001 Rojas D21/680
D445,854 S * 7/2001 Harms D21/680
D667,902 S * 9/2012 Elledge D21/681
D726,264 S * 4/2015 Agate D21/682
D731,006 S * 6/2015 Birt D21/680
9,155,930 B2 * 10/2015 Adkins A63B 21/075
9,844,694 B2 * 12/2017 Birt A63B 23/1209
D812,699 S * 3/2018 Thell D21/680
10,035,037 B2 * 7/2018 Towley A63B 71/0036
D844,719 S * 4/2019 Longazel D21/688
2005/0075221 A1 * 4/2005 Fond A63B 21/0728
482/93

* cited by examiner

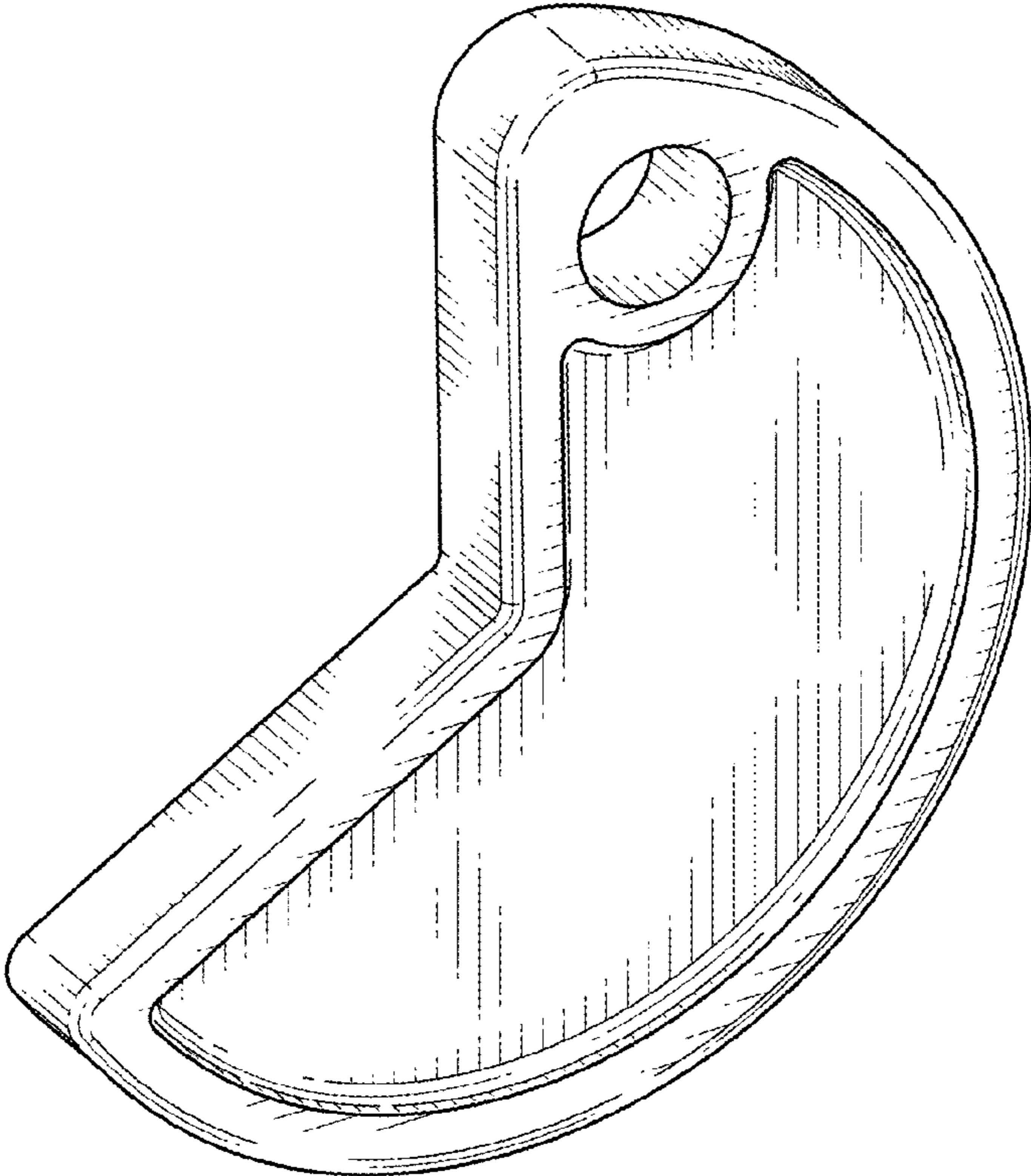

FIG. 1

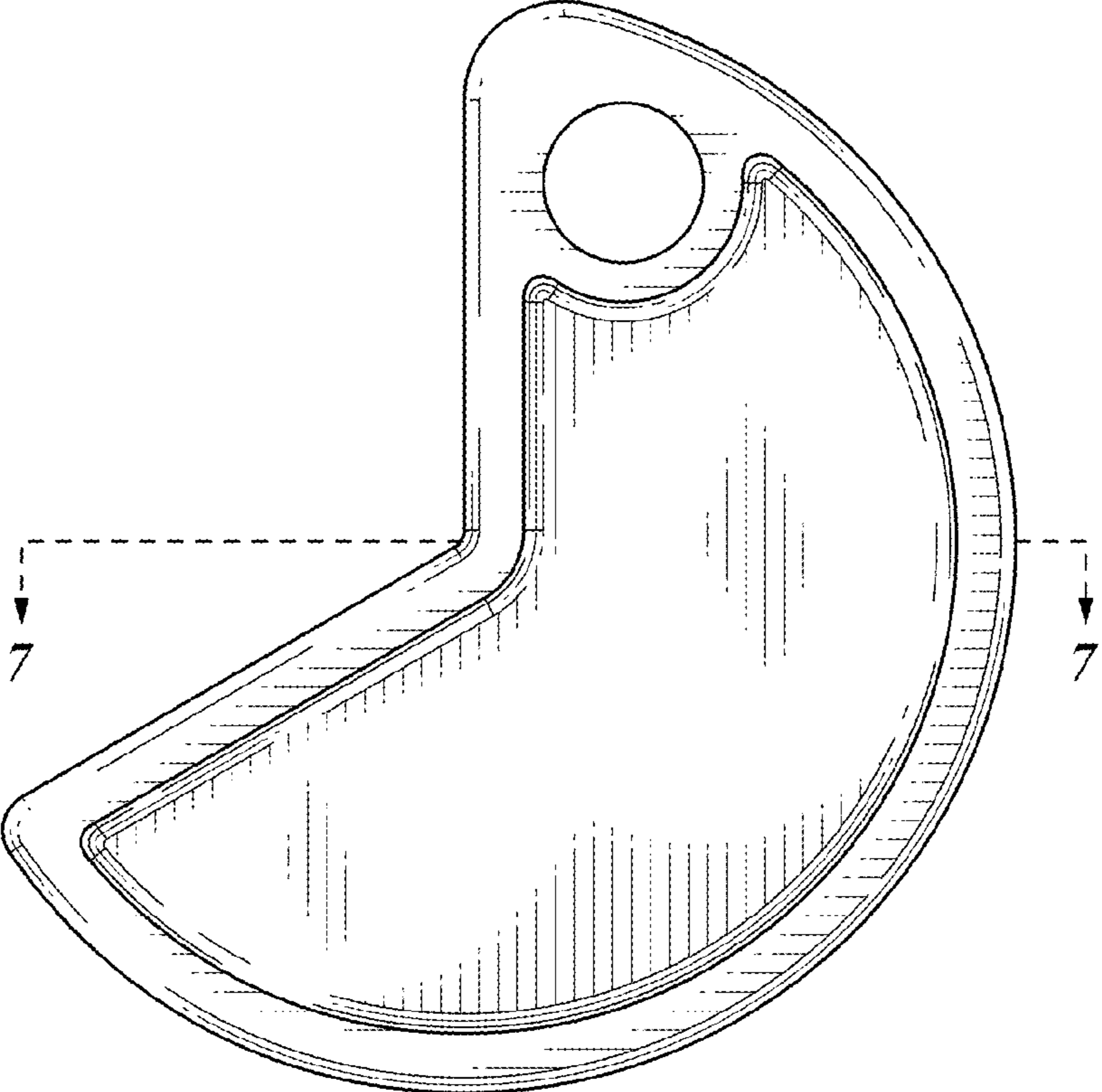

FIG. 2

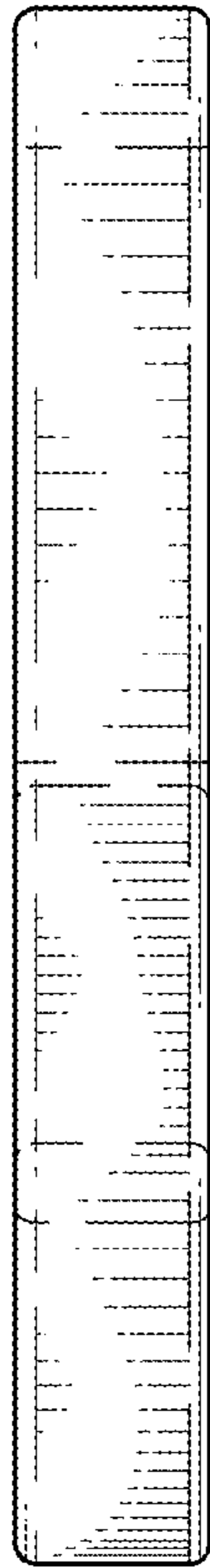

FIG. 3

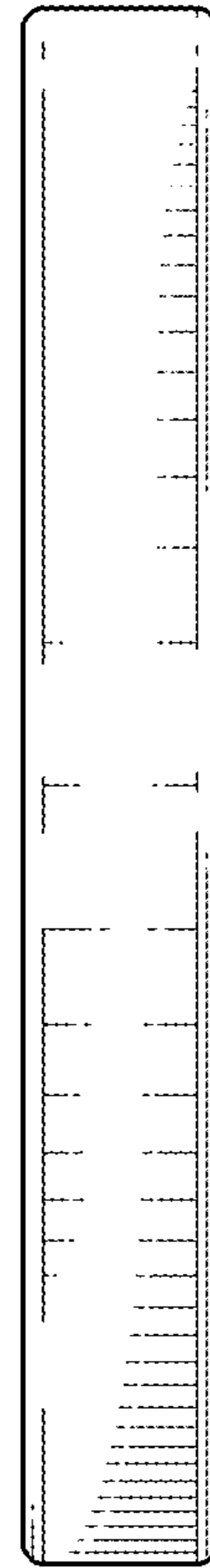

FIG. 4

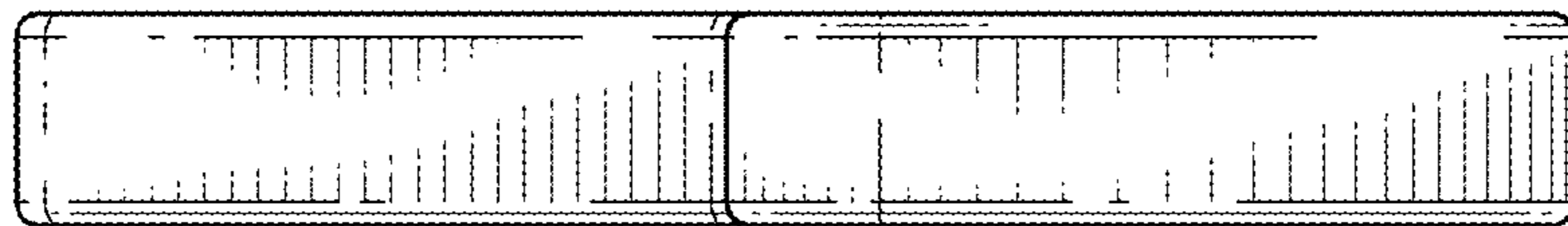

FIG. 5

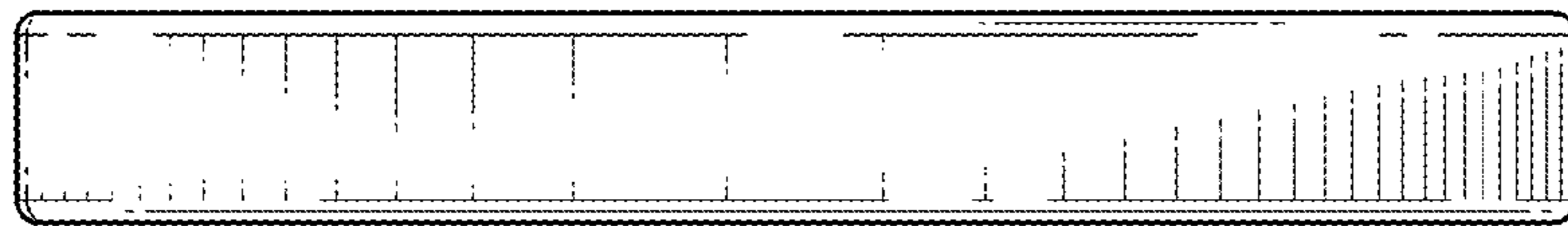

FIG. 6

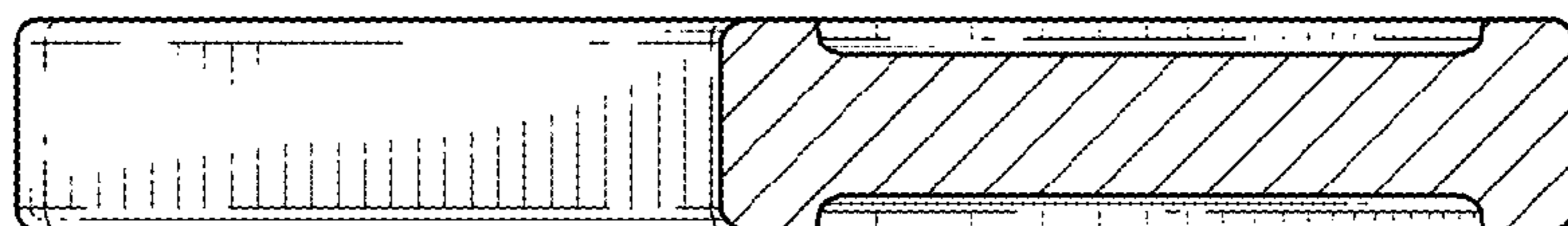

FIG. 7

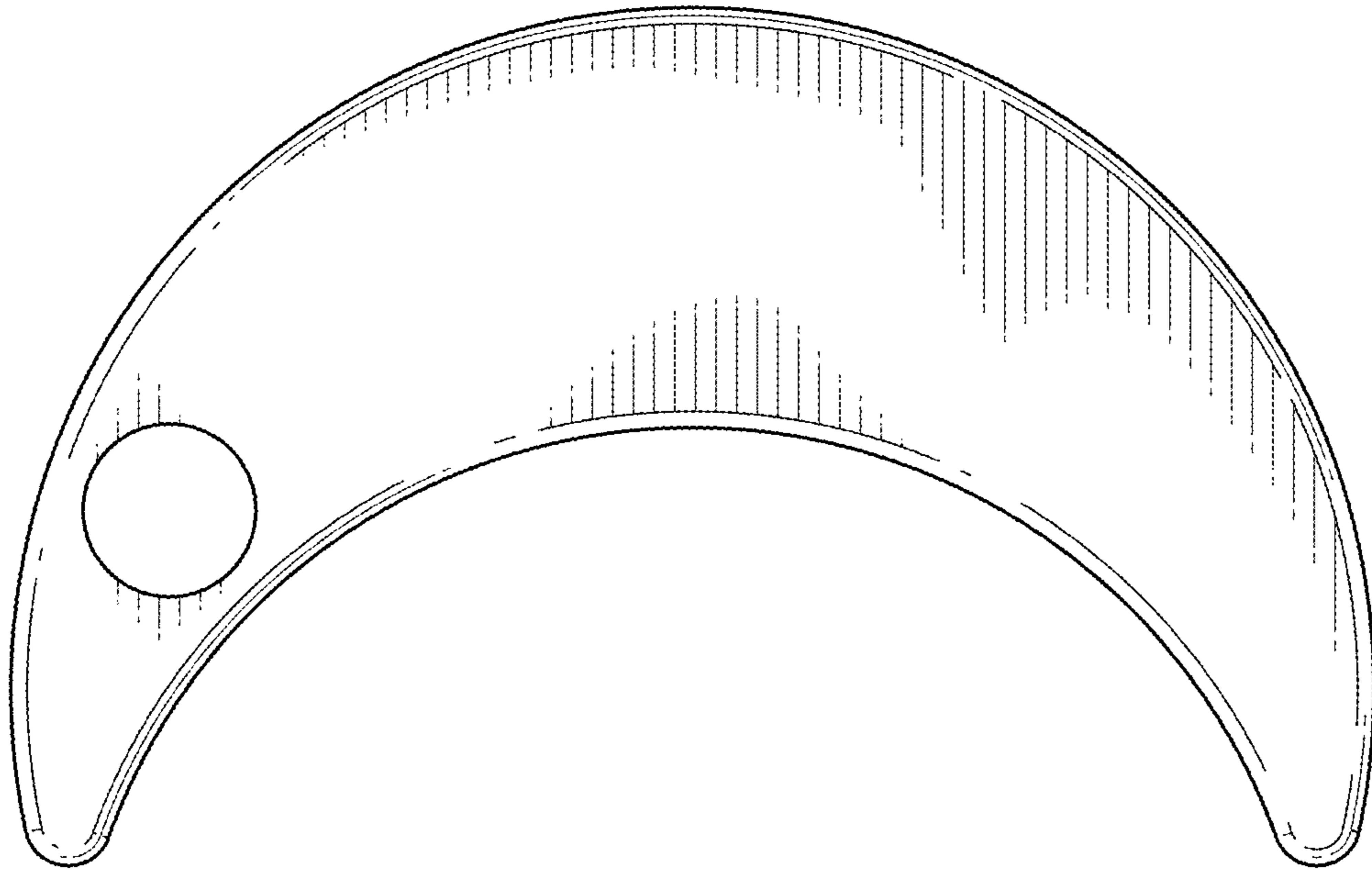

FIG. 9

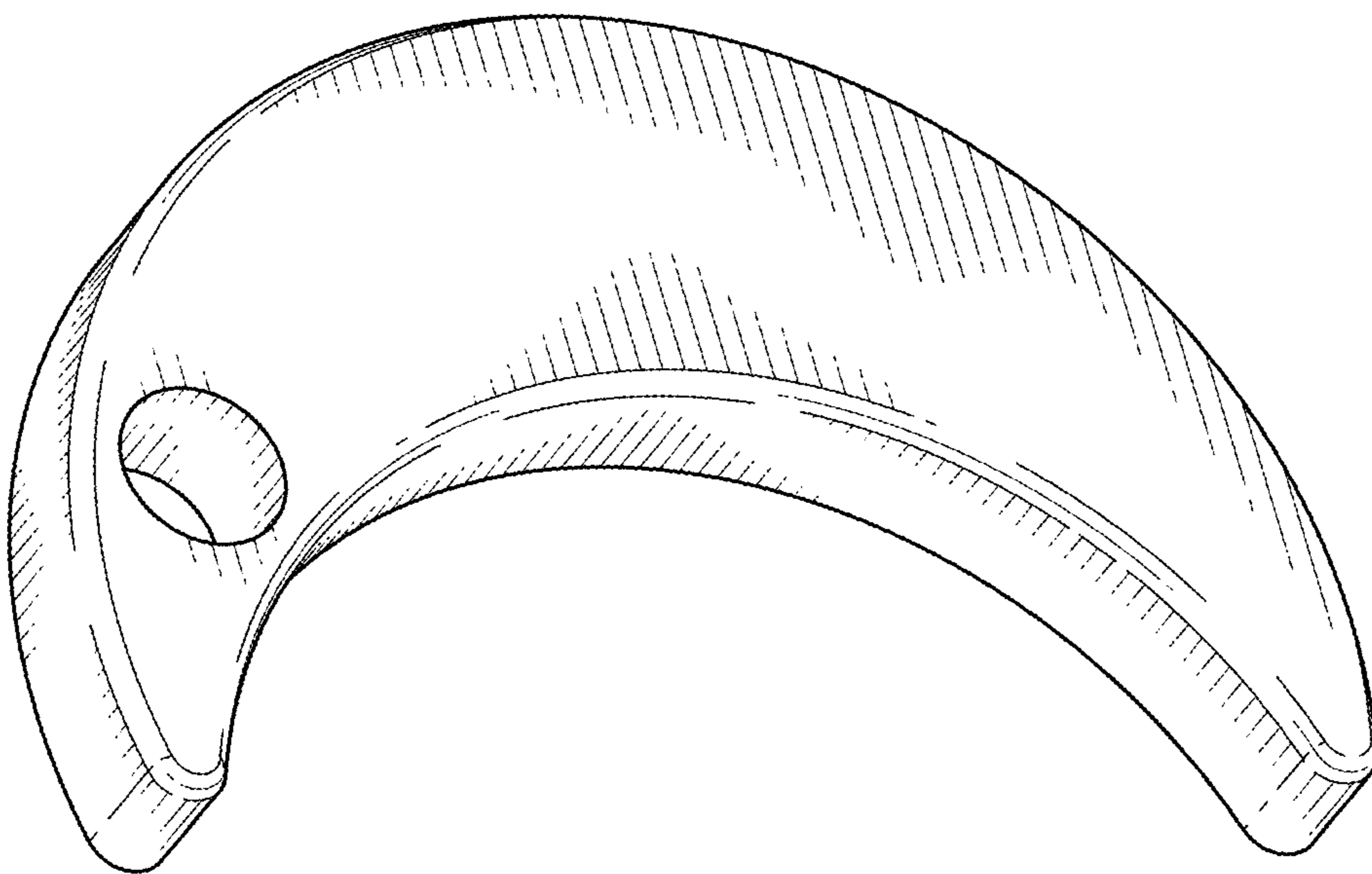

FIG. 8

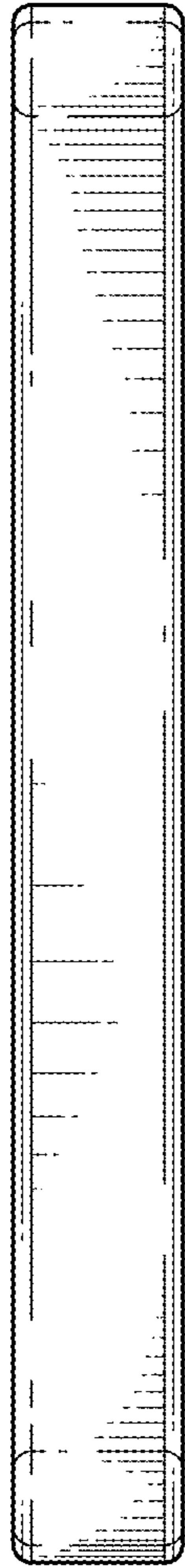

FIG. 10



FIG. 11

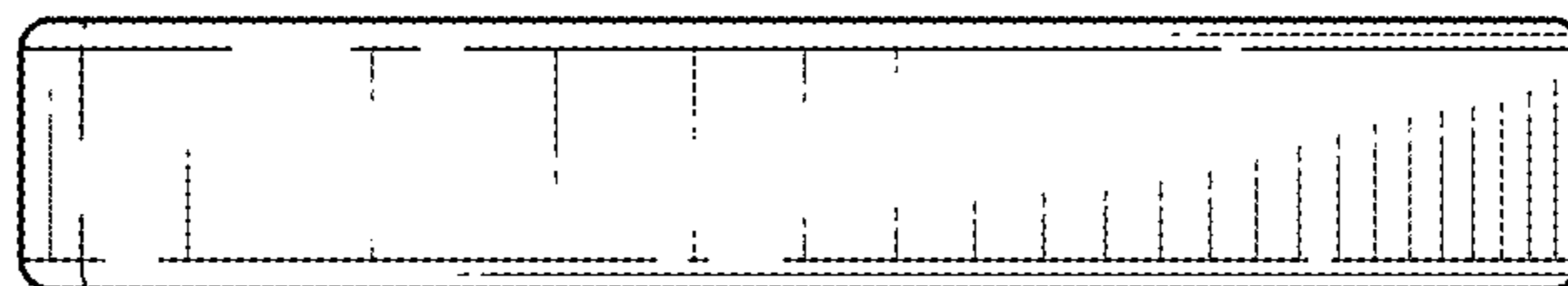

FIG. 12

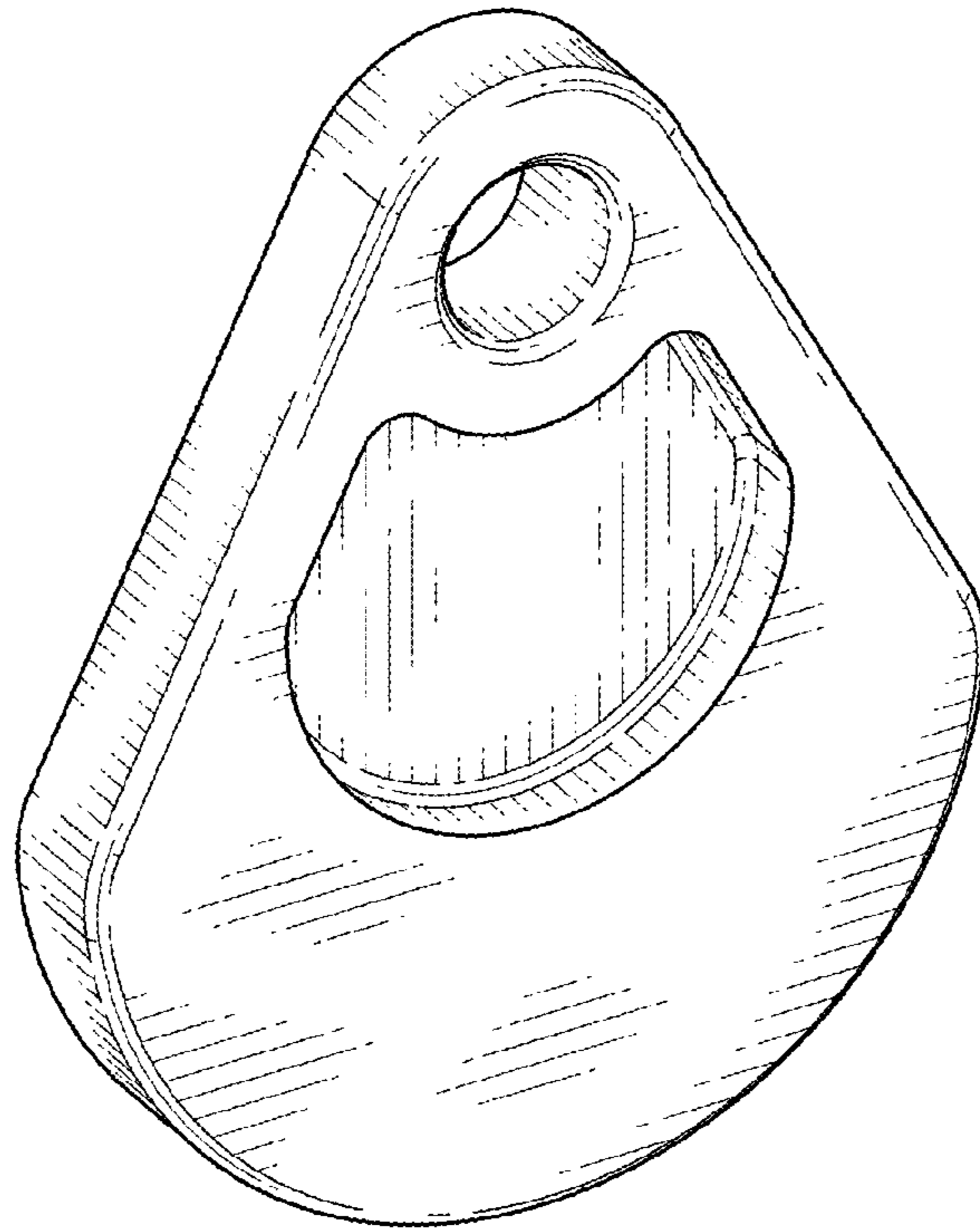

FIG. 13

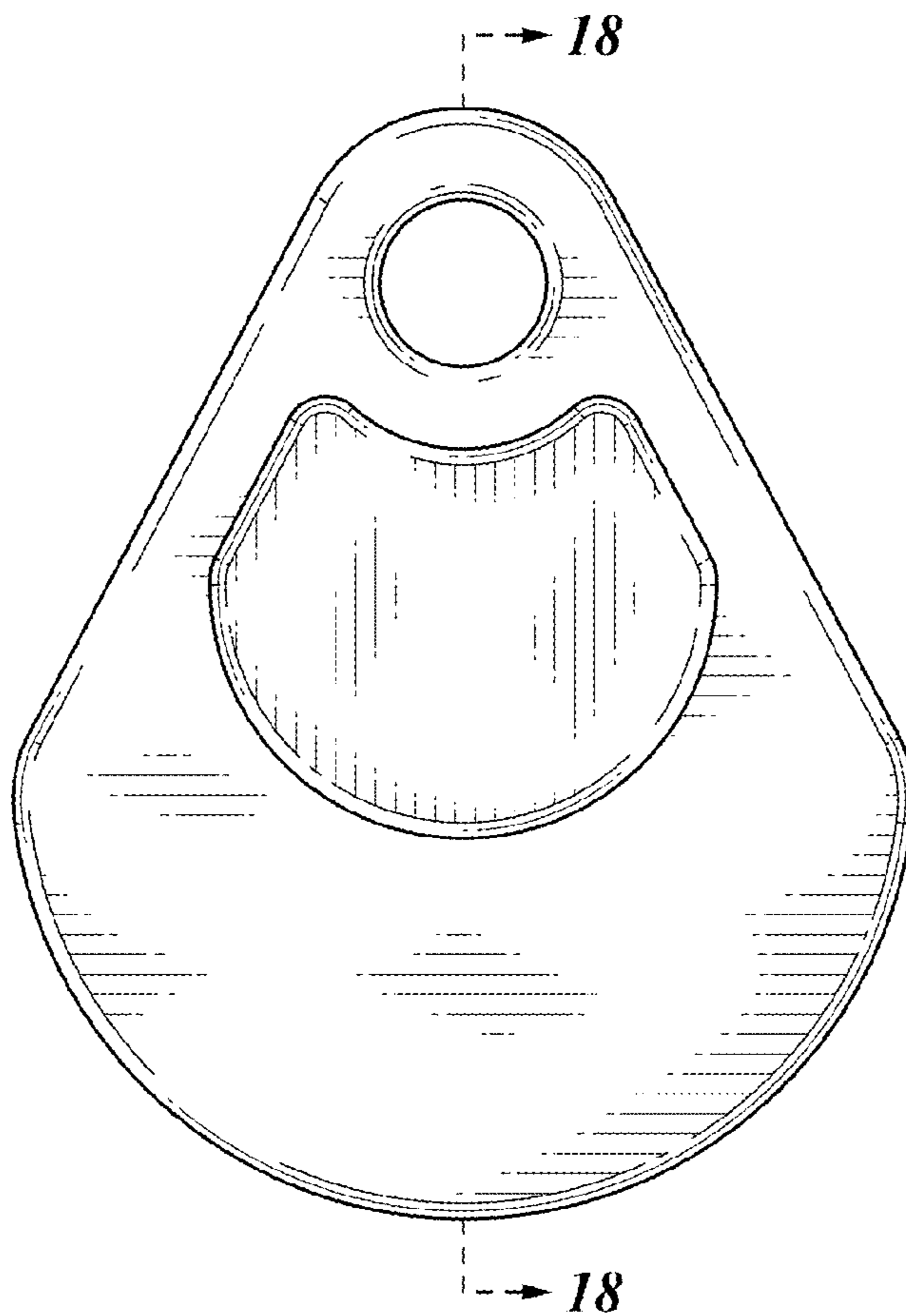

FIG. 14

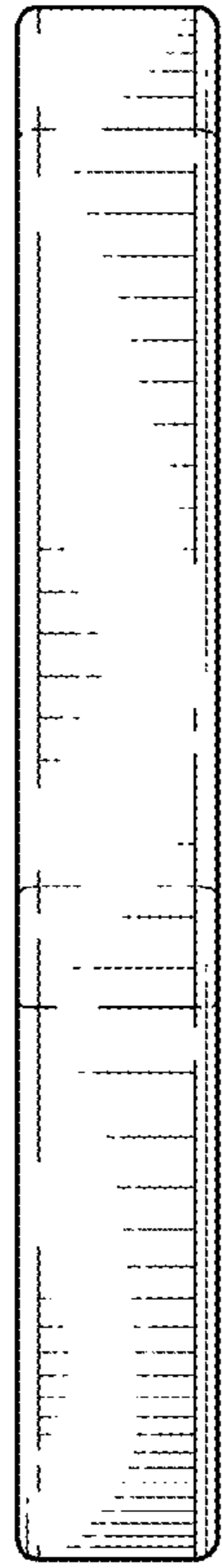

FIG. 15

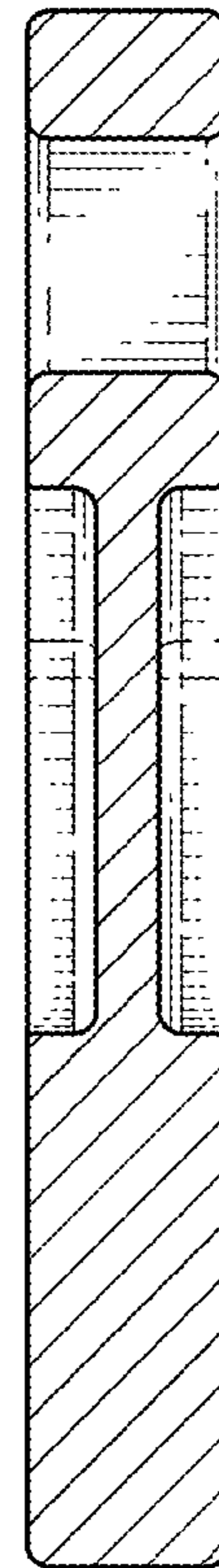

FIG. 18

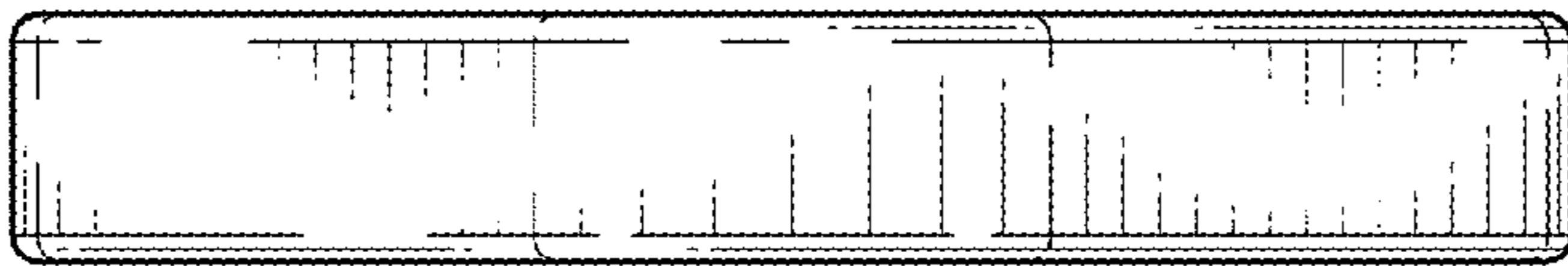

FIG. 16

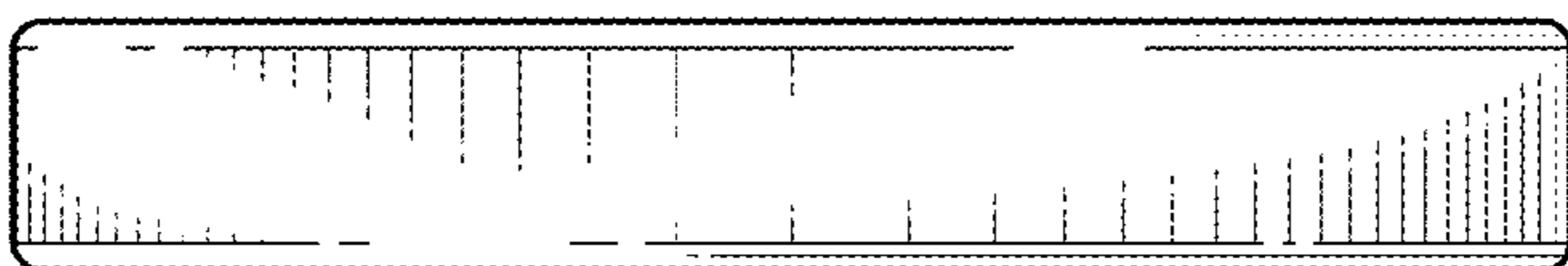

FIG. 17

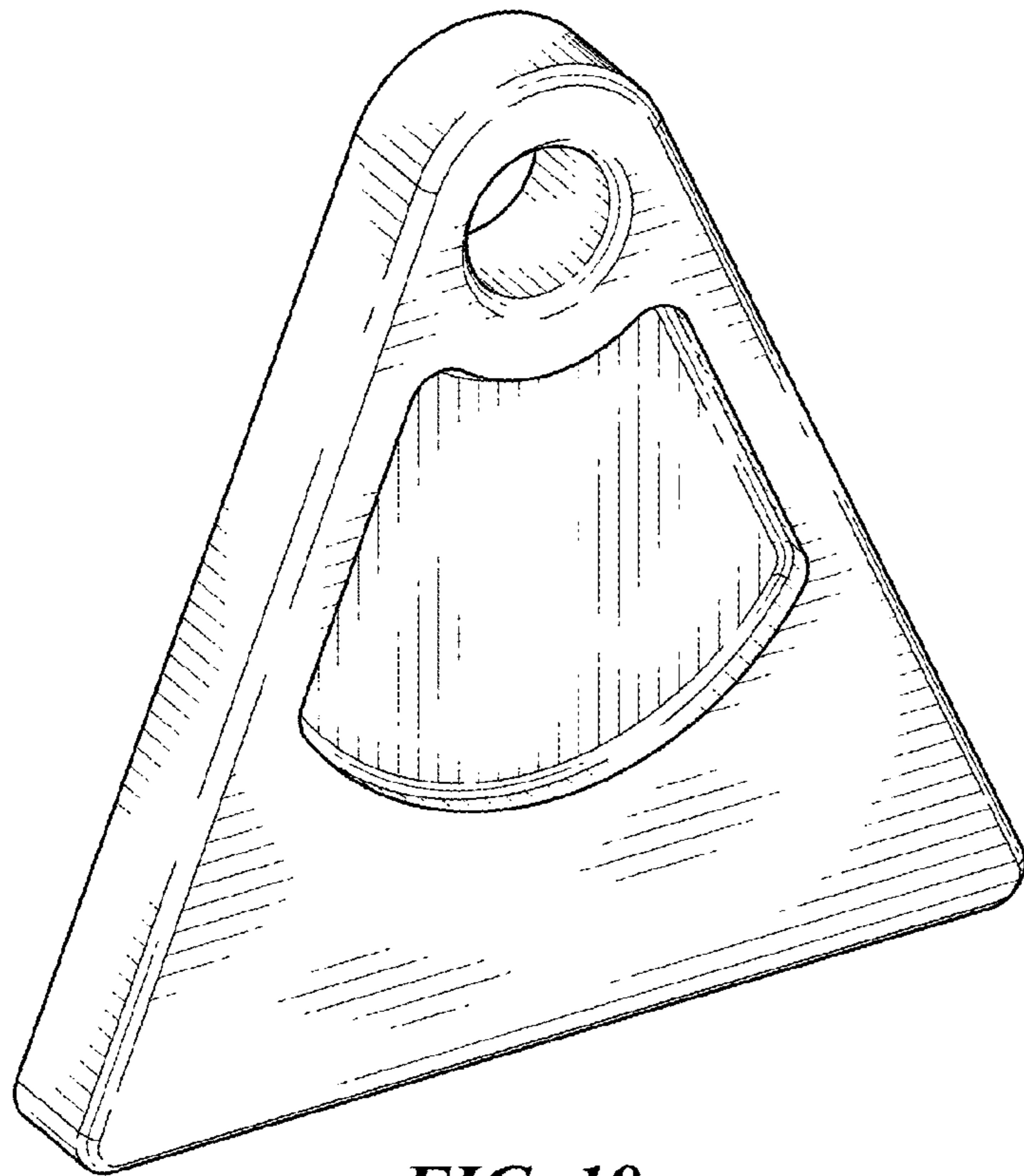

FIG. 19

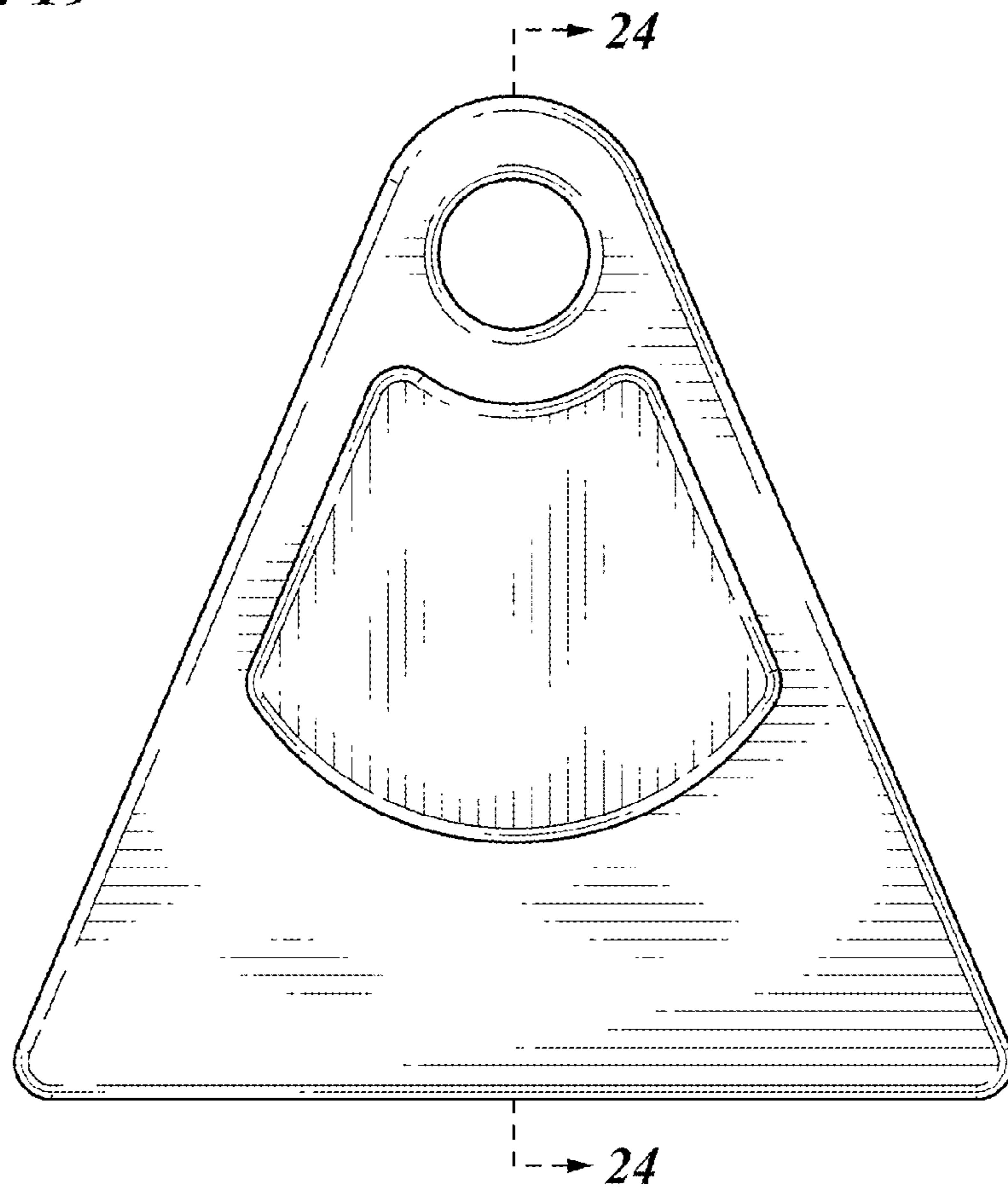

FIG. 20

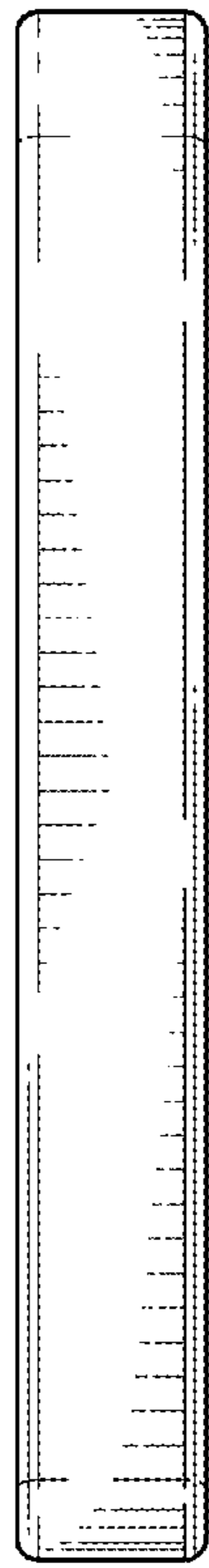

FIG. 21

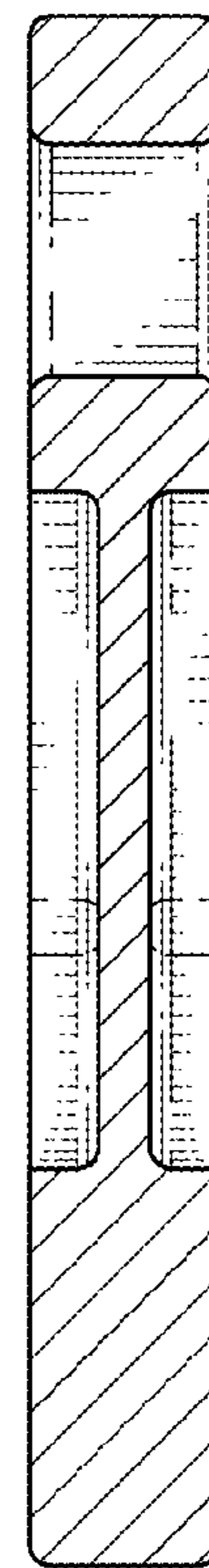

FIG. 24

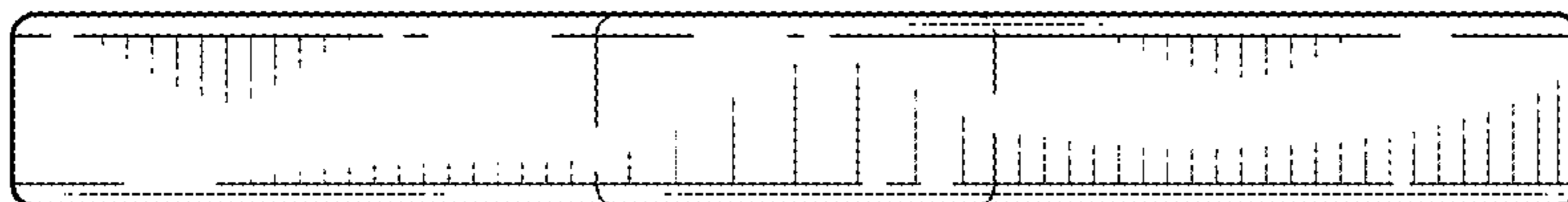

FIG. 22

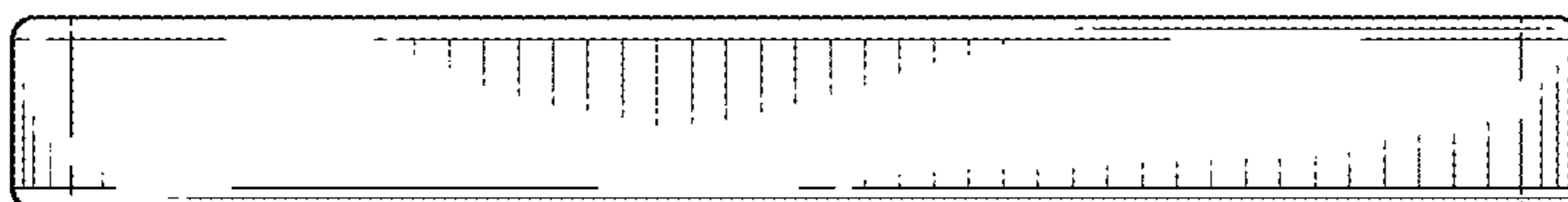

FIG. 23

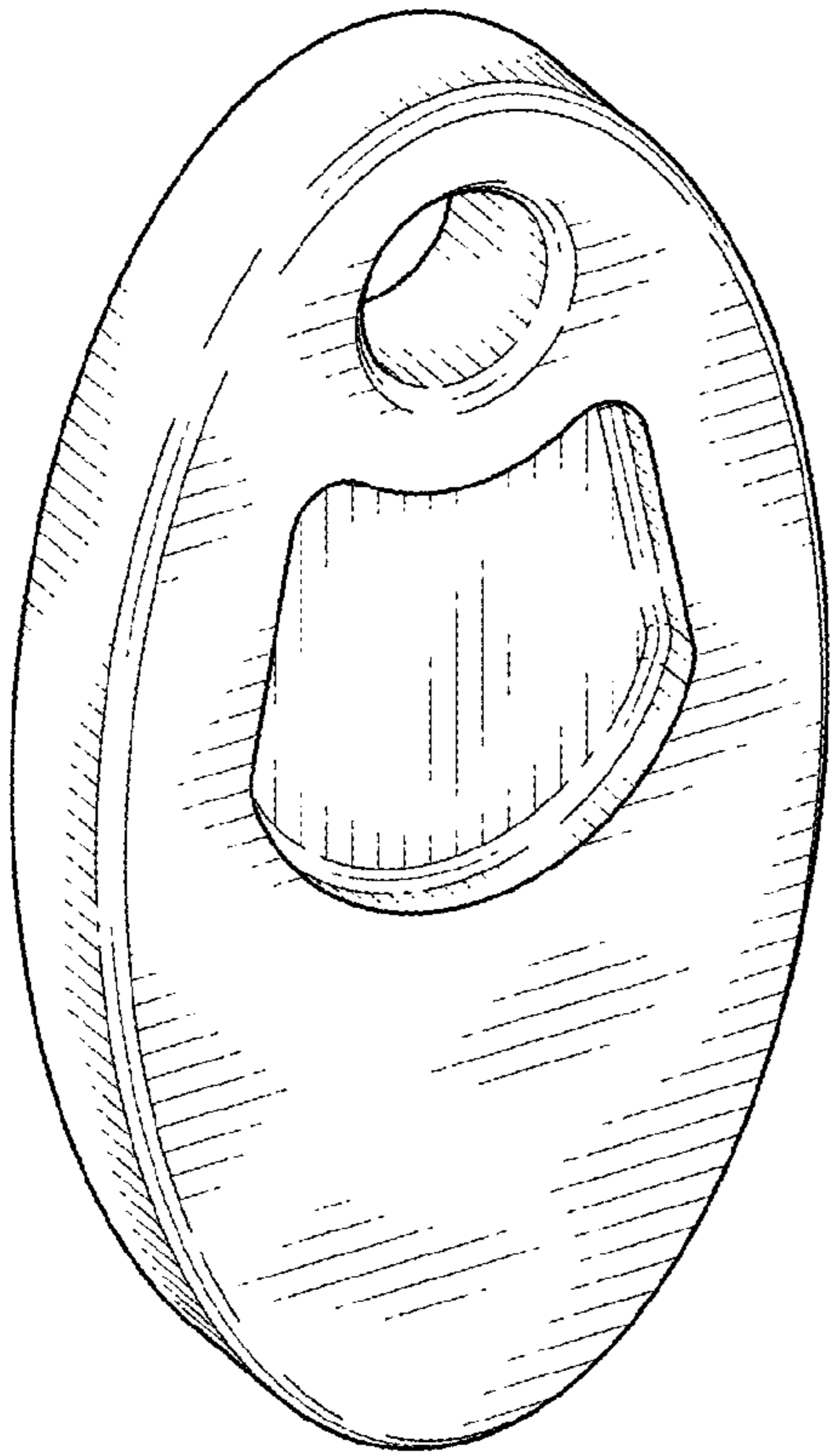

FIG. 25

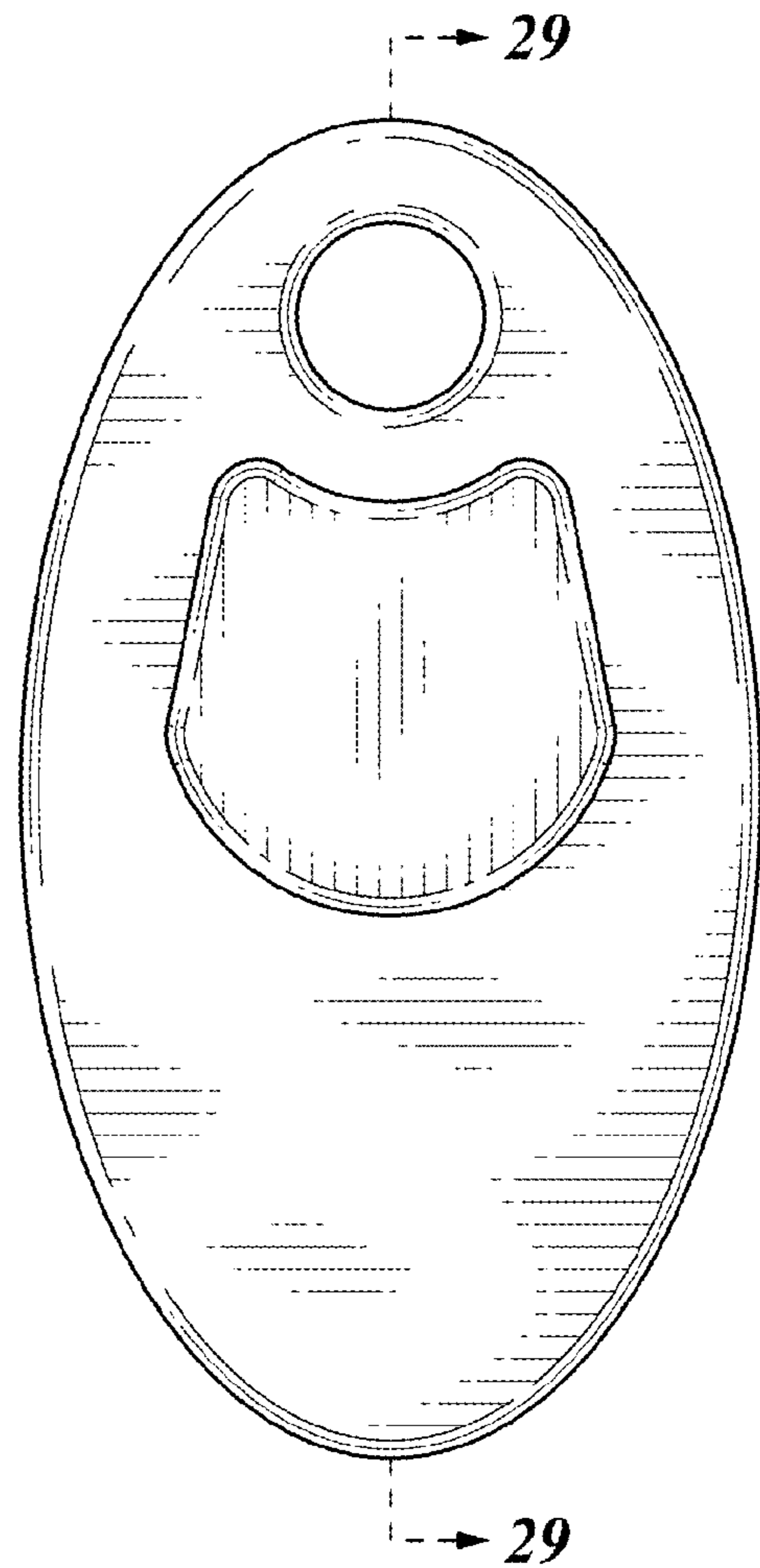

FIG. 26

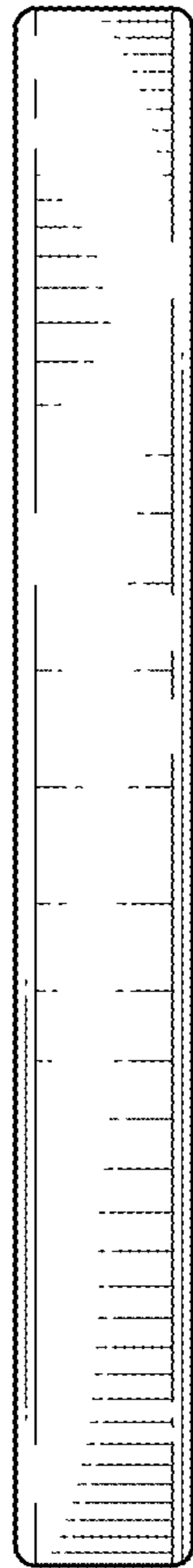

FIG. 27

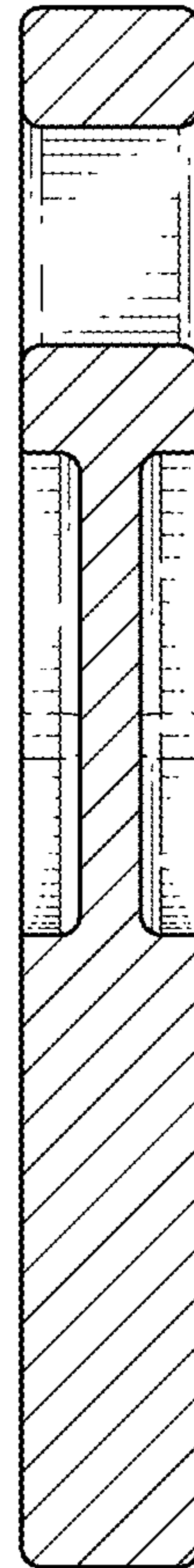

FIG. 29

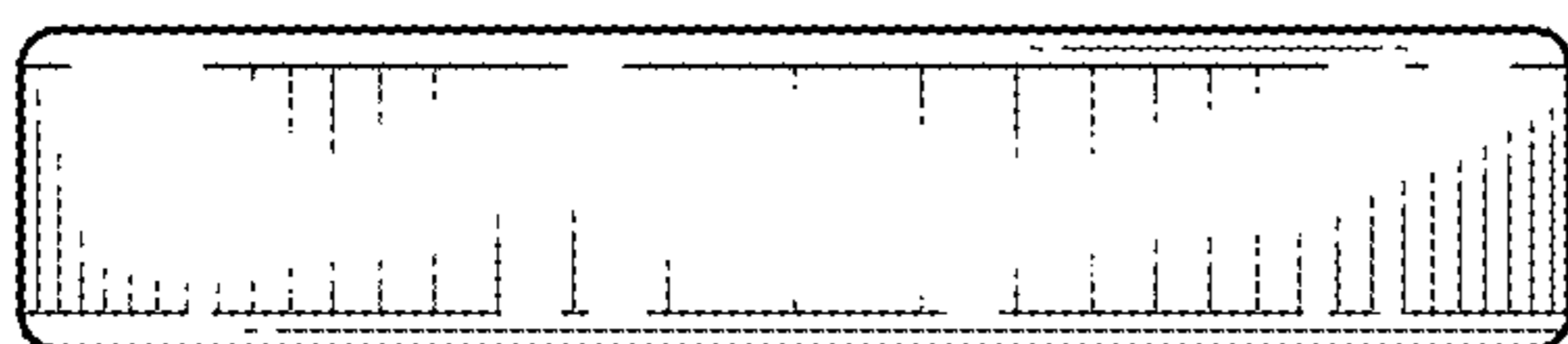

FIG. 28

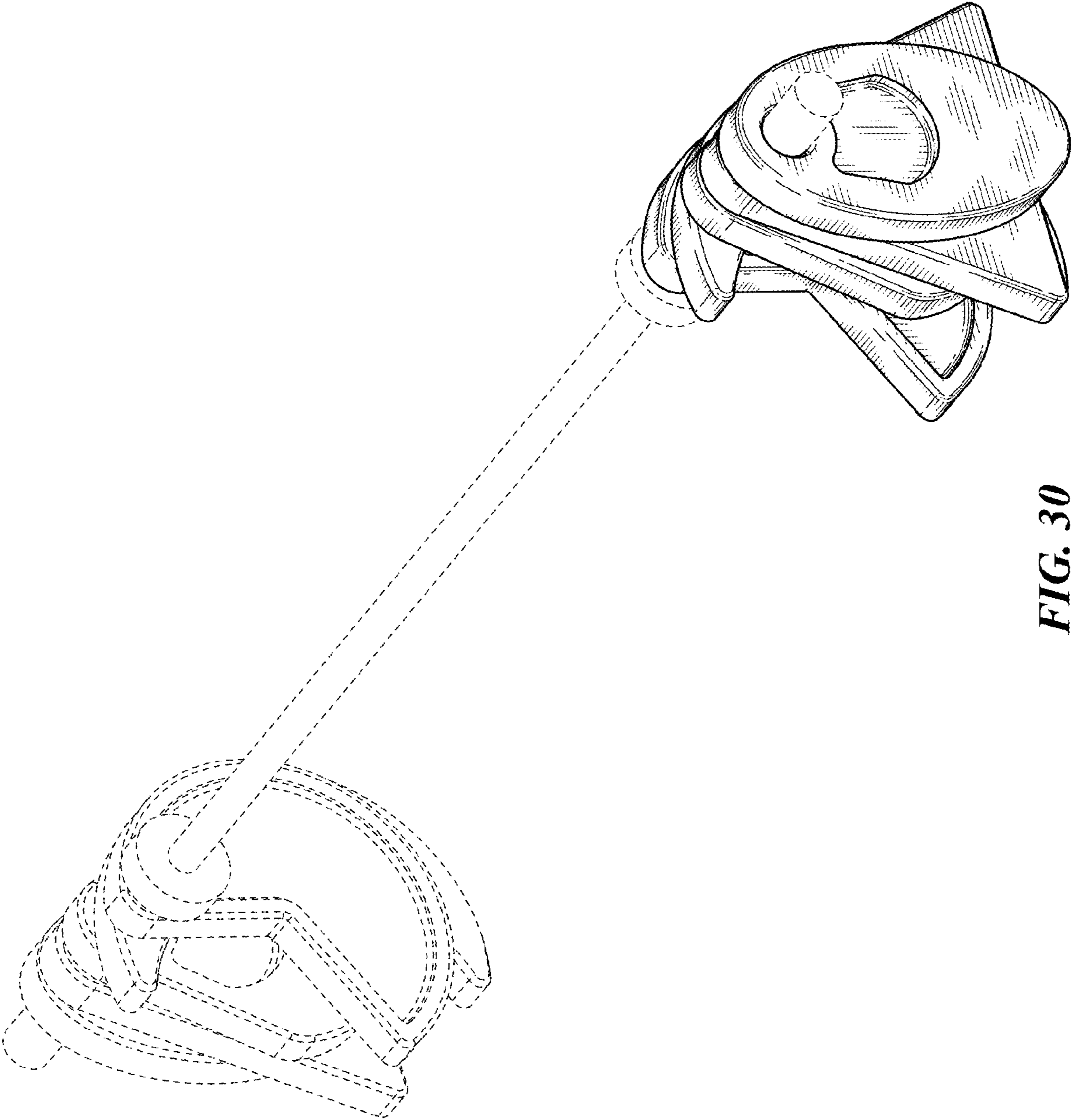

FIG. 30