



US00D963006S

(12) **United States Design Patent** (10) **Patent No.:** **US D963,006 S**
Yeo et al. (45) **Date of Patent:** **** Sep. 6, 2022**

(54) **DOOR WITH REFRIGERATOR AND DELIVERY STORAGE BOX**

locktec.com/en/products/cool-lockers/#&gid=lightbox-group-784 &pid=7> (Year: 2022).*

(Continued)

(71) Applicant: **LG ELECTRONICS INC.**, Seoul (KR)

Primary Examiner — Calvin E Vansant

(72) Inventors: **Insun Yeo**, Seoul (KR); **Kiyeal Seo**, Seoul (KR); **Hyunchul Kim**, Seoul (KR); **Junghoon Lee**, Seoul (KR)

Assistant Examiner — Mark T. Philipps

(74) *Attorney, Agent, or Firm* — Birch, Stewart, Kolasch & Birch, LLP

(73) Assignee: **LG ELECTRONICS INC.**, Seoul (KR)

(57) **CLAIM**

(**) Term: **15 Years**

We claim the ornamental design for a door with refrigerator and delivery storage box, as shown and described.

(21) Appl. No.: **29/730,798**

(22) Filed: **Apr. 8, 2020**

DESCRIPTION

(30) **Foreign Application Priority Data**

Nov. 21, 2019 (KR) 30-2019-0055848

(51) **LOC (13) Cl.** **15-07**

(52) **U.S. Cl.**
USPC **D15/86; D25/48.3; D6/663**

(58) **Field of Classification Search**
USPC D25/48.1, 48.3, 199; D15/79–91;
D6/663, 671.1–671.2; D99/28, 31, 33, 43
(Continued)

FIG. 1 is a front perspective view of a door with refrigerator and delivery storage box showing the new design in a state of the outer door of the delivery storage box opened; FIG. 2 is a rear perspective view thereof; FIG. 3 is a front elevation view thereof; FIG. 4 is a rear elevation view thereof; FIG. 5 is a left side elevation view thereof; FIG. 6 is a right side elevation view thereof; FIG. 7 is a top plan view thereof; FIG. 8 is a bottom plan view thereof; FIG. 9 is a front perspective view of a door with refrigerator and delivery storage box in a state of the inner door of the delivery storage box opened while the outer door is closed; FIG. 10 is a rear perspective view thereof; FIG. 11 is a front elevation view thereof; FIG. 12 is a rear elevation view thereof; FIG. 13 is a left side elevation view thereof; FIG. 14 is a right side elevation view thereof; FIG. 15 is a top plan view thereof; and, FIG. 16 is a bottom plan view thereof. The broken lines in the drawings depict portions of the article that form no part of the claim.

(56) **References Cited**

U.S. PATENT DOCUMENTS

2,111,411 A * 3/1938 Spreen F25D 25/02
126/340
2,815,649 A * 12/1957 Di Angelus F25D 25/02
312/351

(Continued)

OTHER PUBLICATIONS

LockTec, Refrigerated pickup station—cool lockers by LockTec, (site visited Apr. 29, 2022), LockTec Website, URL:<https://www.

1 Claim, 16 Drawing Sheets

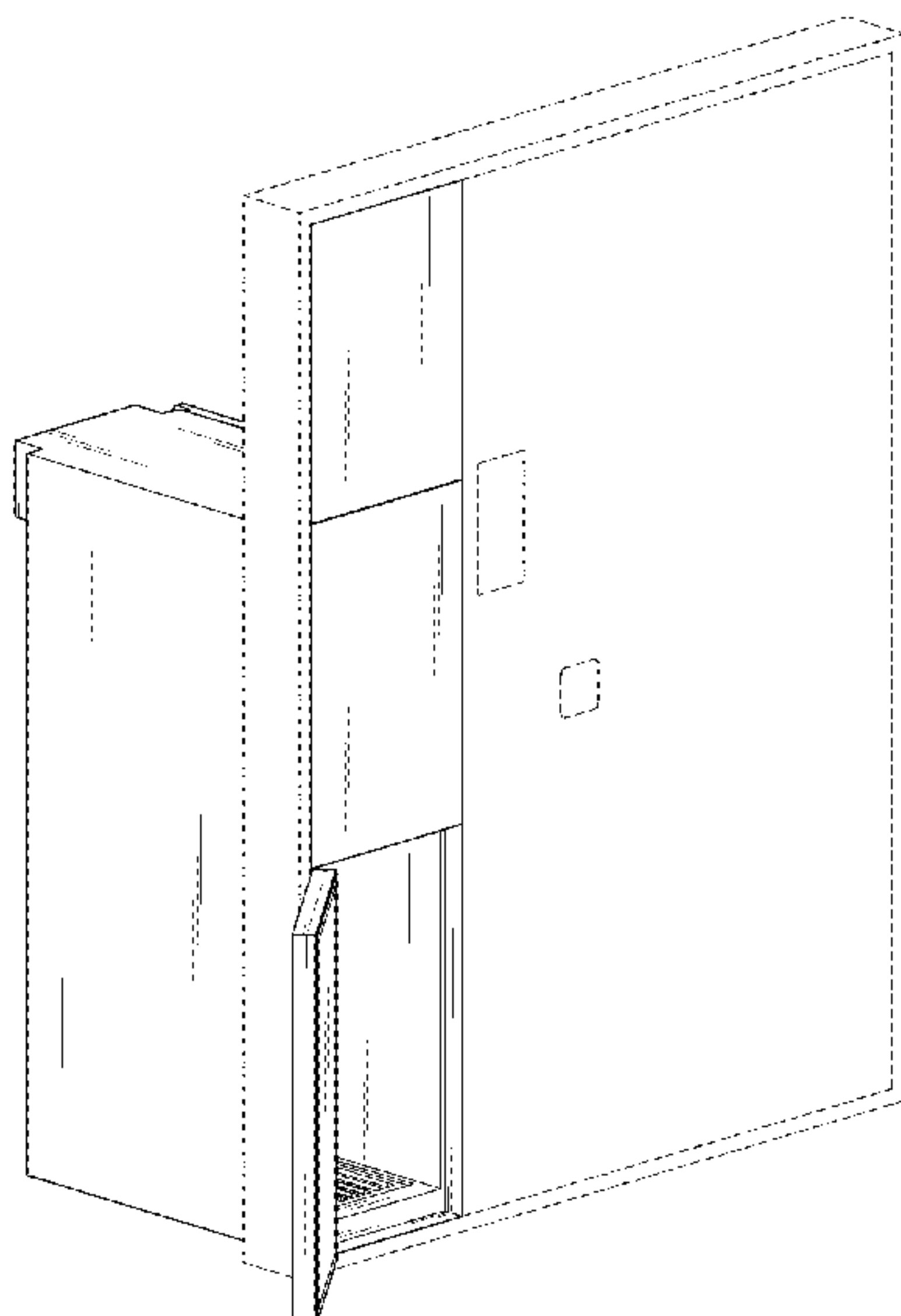

(58) **Field of Classification Search**

CPC F25D 25/02; F25D 25/021; F25D 25/022;
 F25D 25/024; F25D 25/025; F25D
 2323/00; F25D 2323/021; F25D
 2323/024; F25D 2325/021; F25D 17/042;
 F25D 27/005; F25D 29/00; F25D 29/005;
 F25D 2300/00; F25D 2331/80; F25D
 11/00; F25D 11/02; F25D 11/025; F25D
 23/00; F25D 23/02; F25D 23/04; F25D
 23/12; F25D 23/028; A47F 3/04; A47F
 3/0404

See application file for complete search history.

(56) **References Cited**

U.S. PATENT DOCUMENTS

3,971,231 A * 7/1976 Derry F25D 3/12
 62/449
 4,725,107 A * 2/1988 Appleton F25D 11/02
 312/283
 D363,618 S * 10/1995 Cramer D6/671.1
 D607,019 S * 12/2009 Becke D15/87
 D617,353 S * 6/2010 Jeon D15/86
 D647,544 S * 10/2011 Kristiansen D15/86
 D659,725 S * 5/2012 Wolfe D15/85
 D714,359 S * 9/2014 Kim D15/85
 D721,746 S * 1/2015 Ryu D15/86
 D785,055 S * 4/2017 Kim D15/85
 D786,316 S * 5/2017 Lee D15/85
 D786,319 S * 5/2017 Kwak D15/86
 D791,202 S * 7/2017 Kwak D15/91
 D799,148 S * 10/2017 Crosby D99/28
 D811,686 S * 2/2018 Crosby D99/28
 D818,012 S * 5/2018 Kim F25D 23/00
 D15/91
 D824,965 S * 8/2018 Lee D15/91
 D876,044 S * 2/2020 Sisco D99/28
 D876,491 S * 2/2020 Yu F25D 23/025
 D15/79

D880,543 S * 4/2020 Luchetta F25D 17/062
 D15/91
 D905,766 S * 12/2020 Vernon D15/79
 D908,748 S * 1/2021 Lee D15/91
 D912,338 S * 3/2021 Kim D32/10
 D914,772 S * 3/2021 Kim F25D 25/025
 D15/89
 D921,711 S * 6/2021 Lee D15/85
 D924,278 S * 7/2021 Choi F25D 25/025
 D15/79
 D925,619 S * 7/2021 Kim D15/91
 D928,853 S * 8/2021 Kim D15/91
 D929,473 S * 8/2021 Yeo F25D 23/02
 D15/85
 D943,646 S * 2/2022 Kim F25D 25/025
 D15/91
 D947,256 S * 3/2022 Myung F25D 25/025
 D15/79
 2010/0256800 A1* 10/2010 Heffron G07F 11/62
 312/327
 2014/0318157 A1* 10/2014 Knudsen F25D 11/02
 62/62
 2017/0061373 A1* 3/2017 Hara G06Q 10/0836
 2017/0188542 A1* 7/2017 Dix A01K 1/035
 2018/0172337 A1* 6/2018 Choi F25D 23/02
 2019/0271500 A1* 9/2019 Lee F25D 27/005
 2020/0123824 A1* 4/2020 Yang A47B 87/0284
 2020/0408028 A1* 12/2020 Schmider E05G 1/04
 2021/0217261 A1* 7/2021 Green G08C 17/02

OTHER PUBLICATIONS

Smiota, Play It Cool With Refrigerated Package Lockers, (Jul. 17, 2018), Smiota website, URL:<<https://smiota.com/resources/play-cool-refrigerated-package-lockers/>> (Year: 2018).*

Luxer One, Luxer Lockers: Designed & Built in the USA, (site visited Apr. 29, 2022), Luxer One Website, URL:<<https://www.luxerone.com/product/luxer-lockers/>> (Year: 2022).*

* cited by examiner

FIG. 1

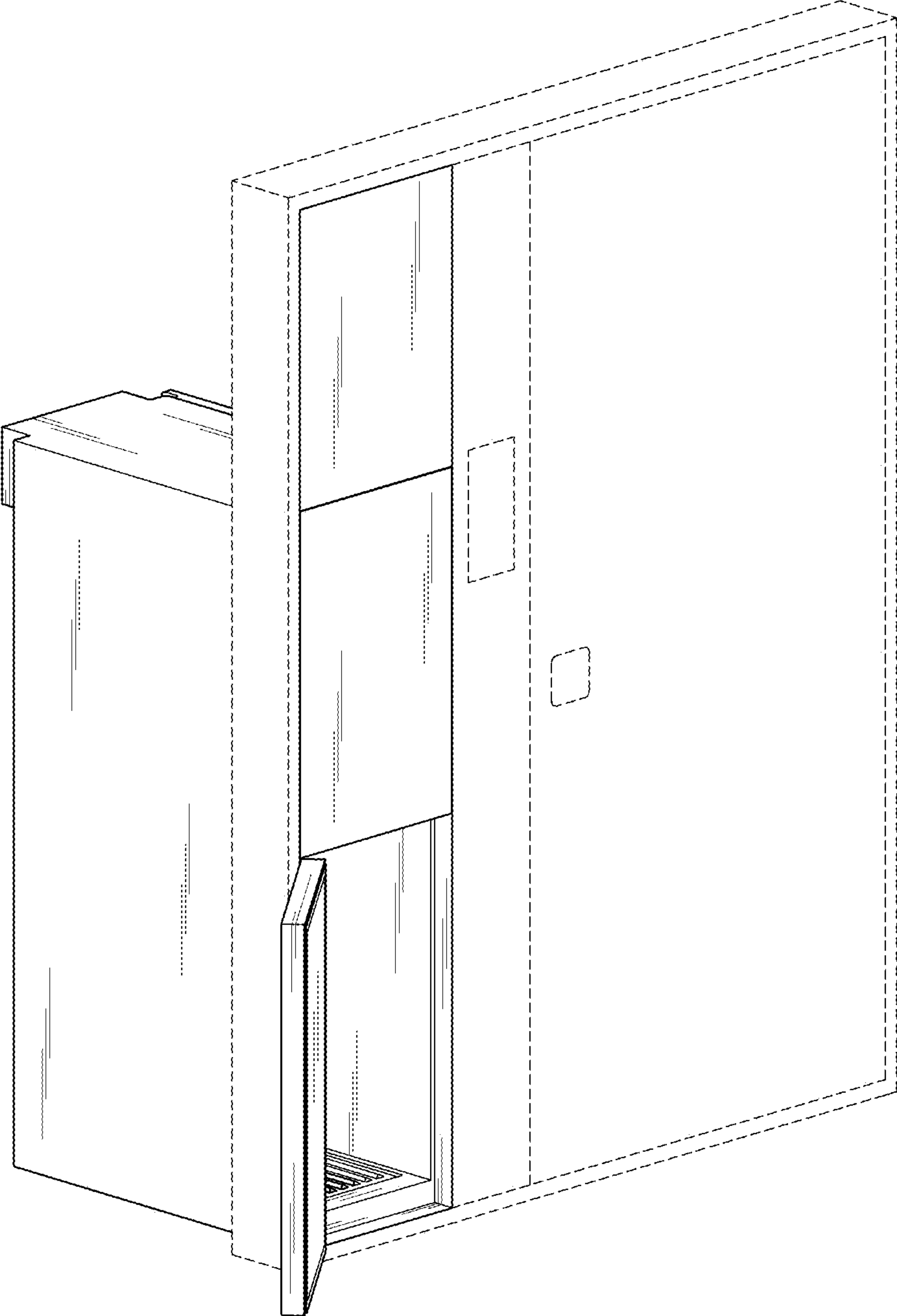

FIG. 2

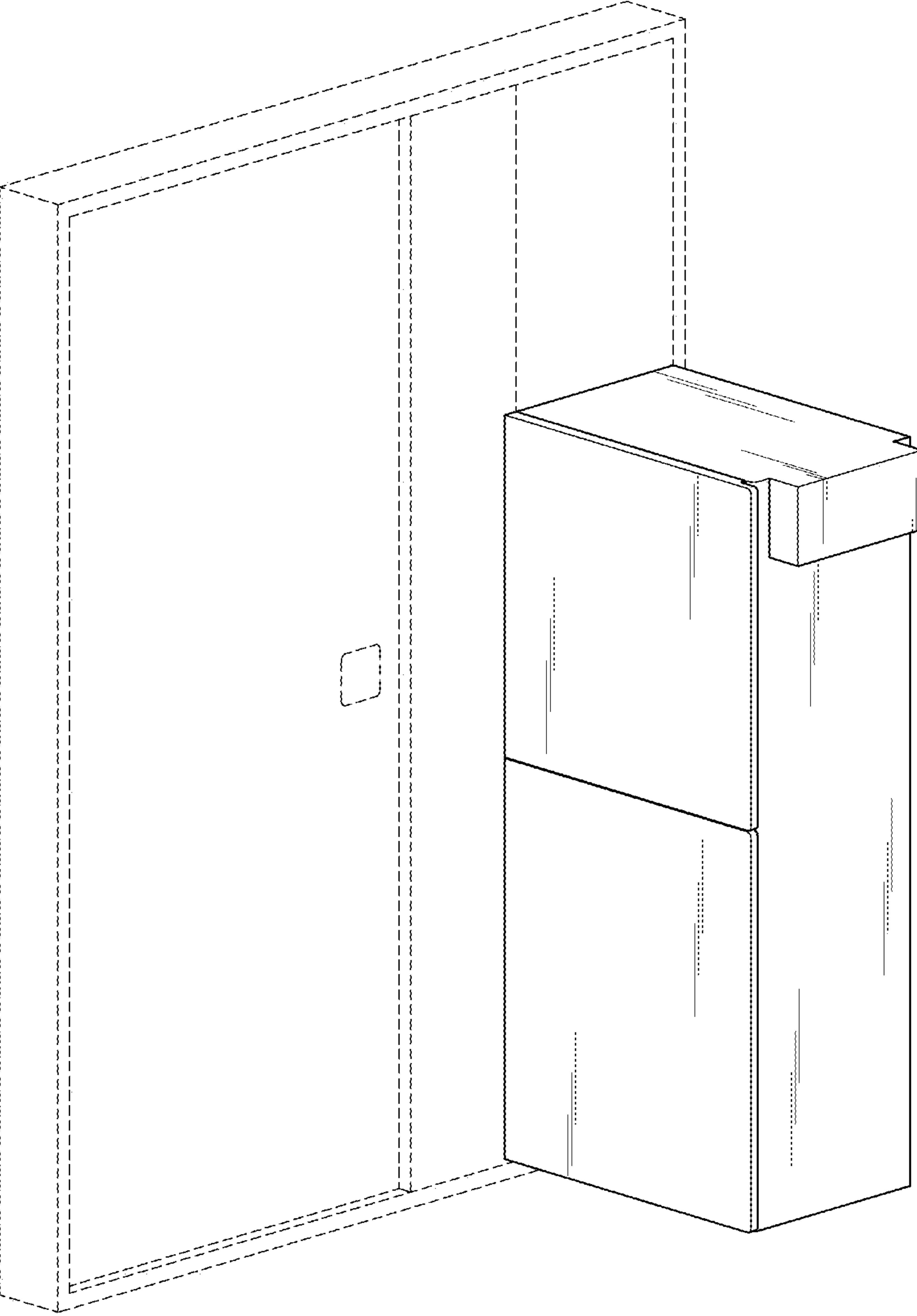

FIG. 3



FIG. 4

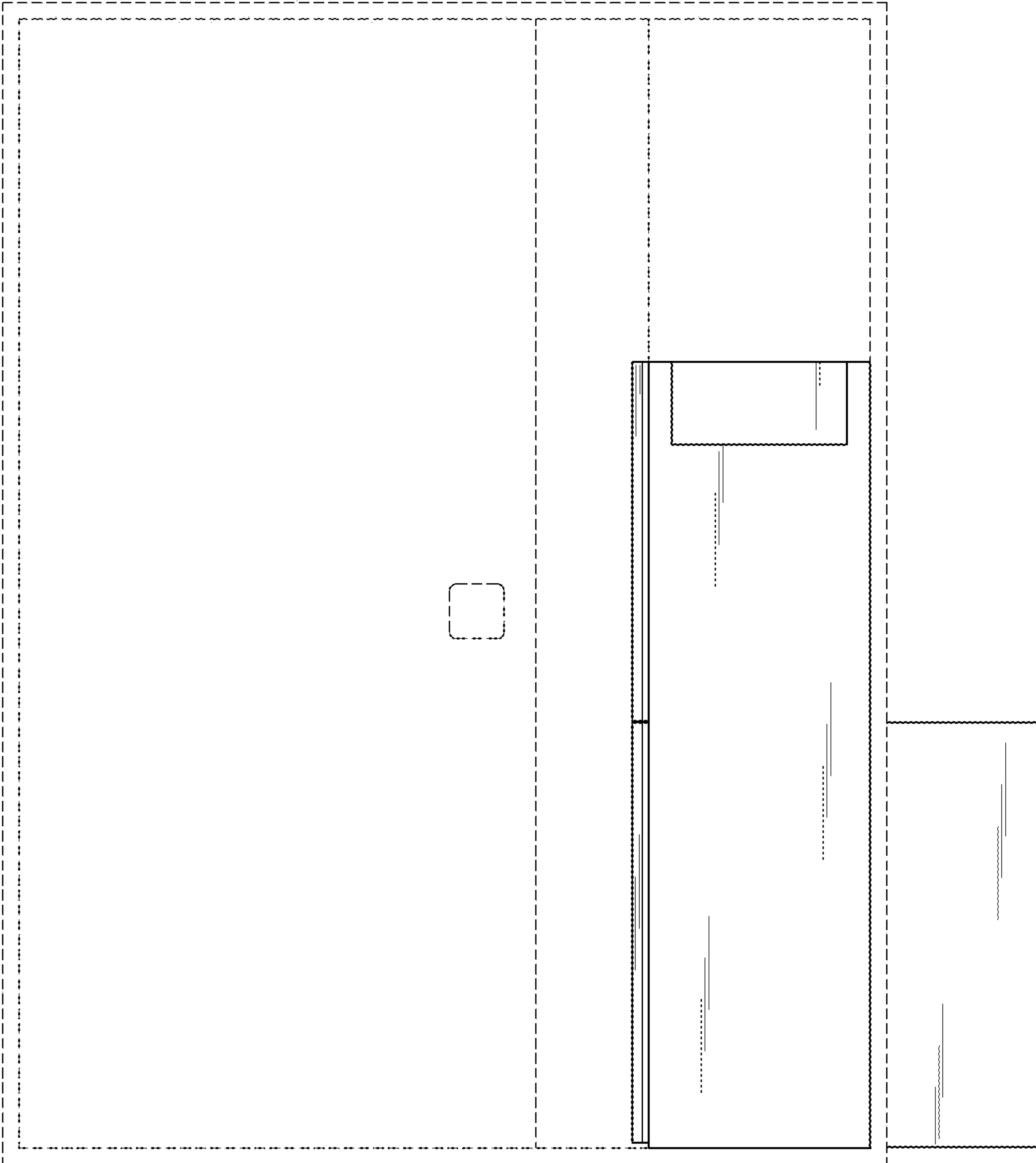

FIG. 5

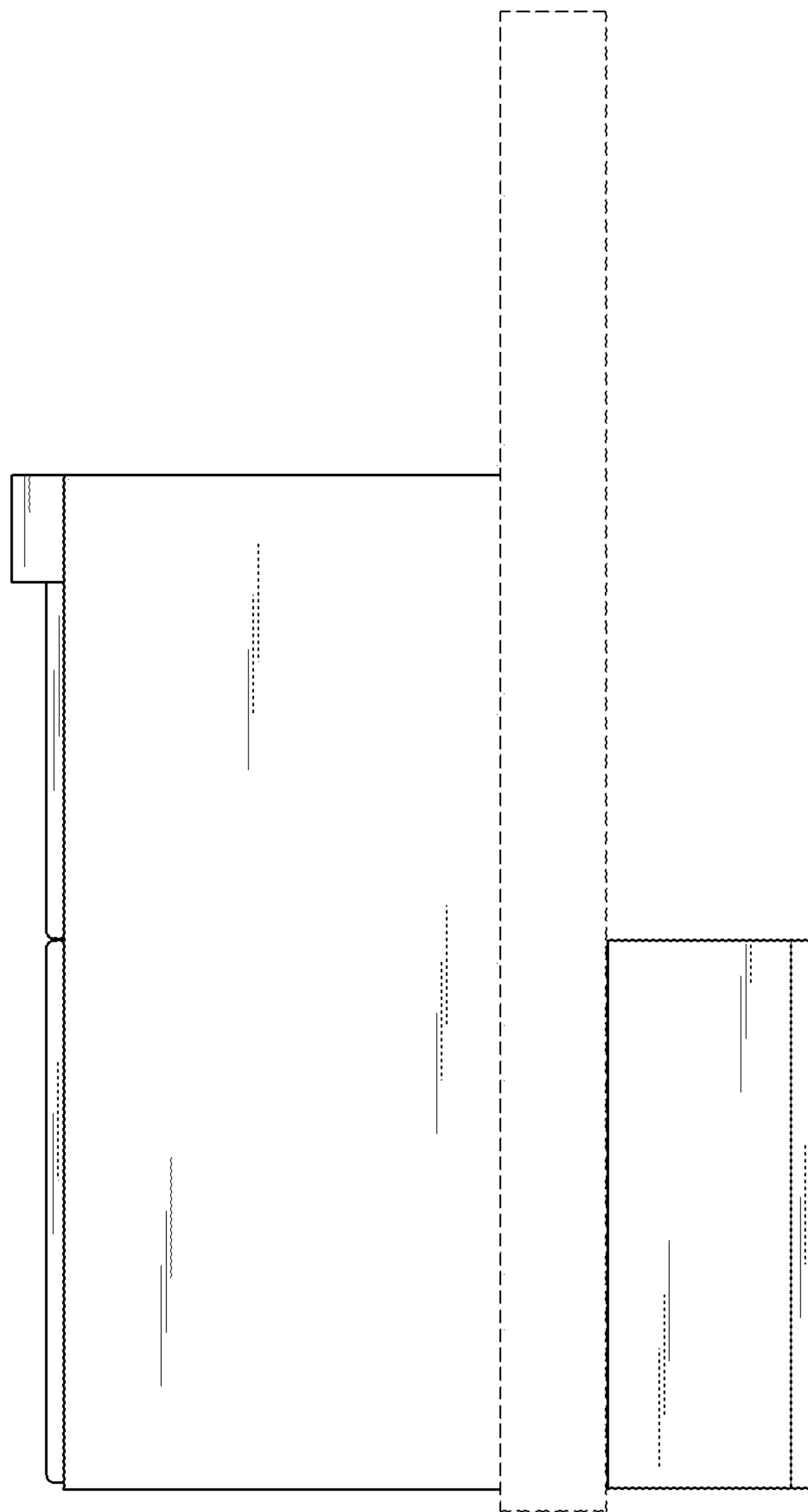

FIG. 6

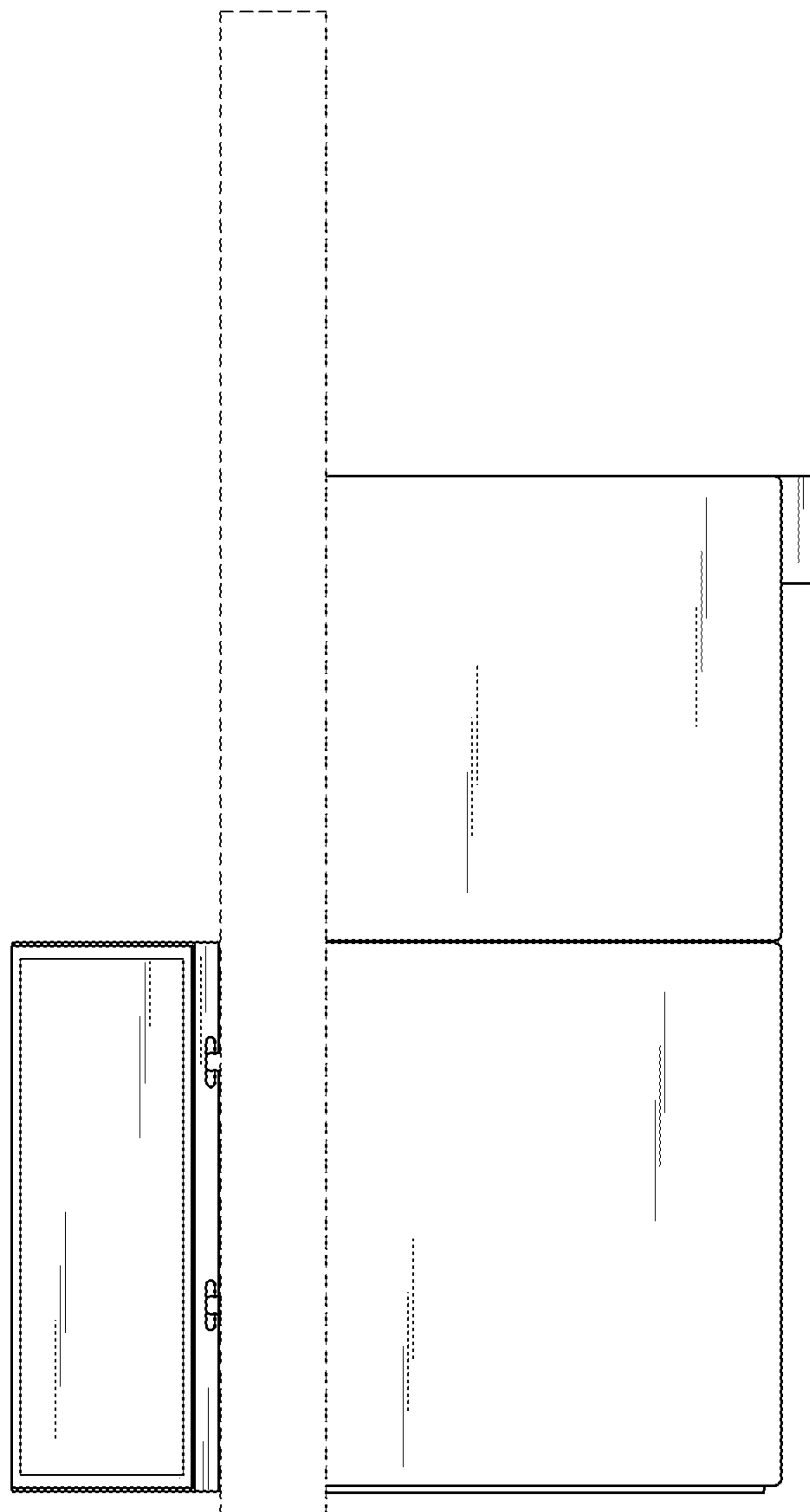

FIG. 7

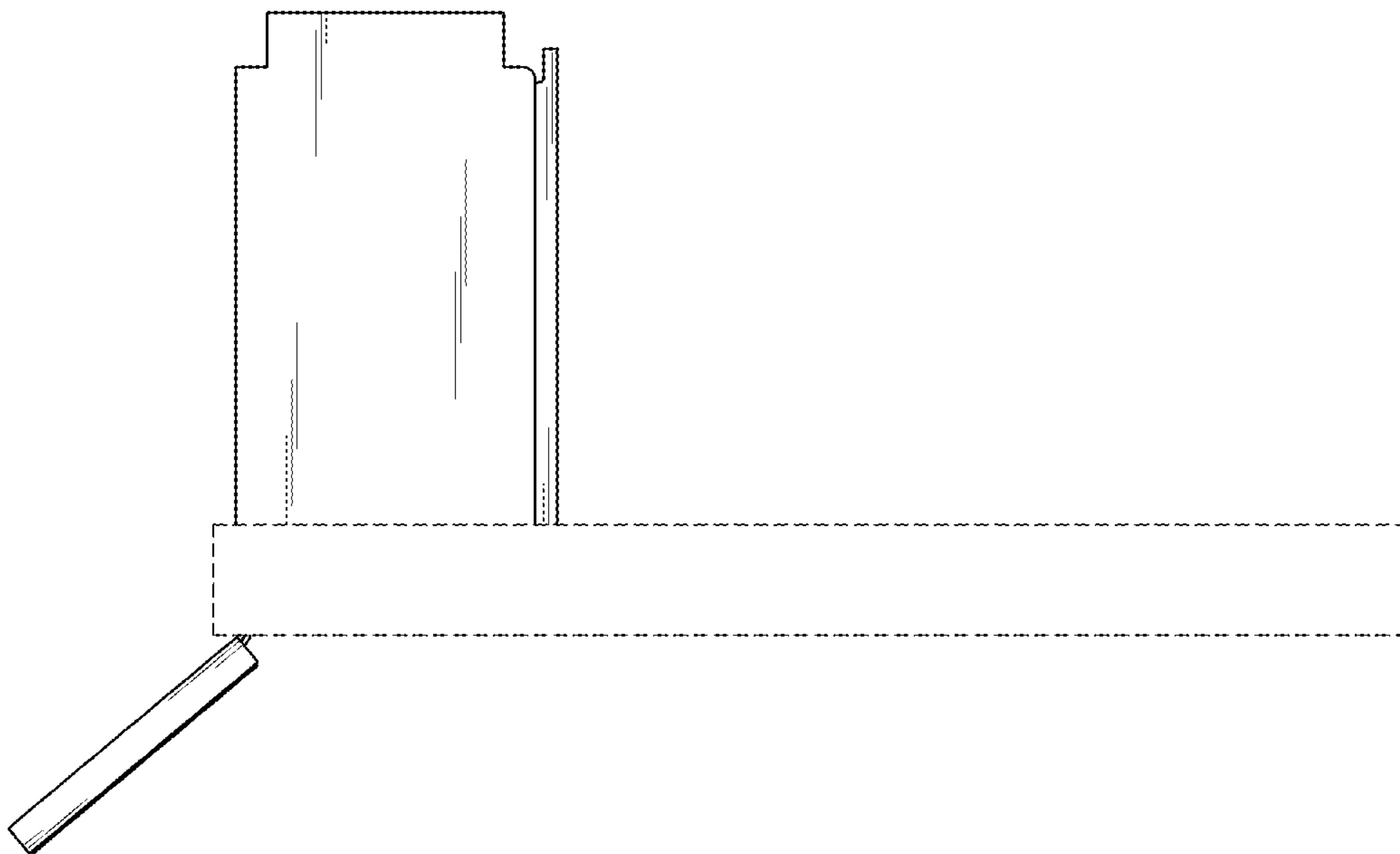

FIG. 8

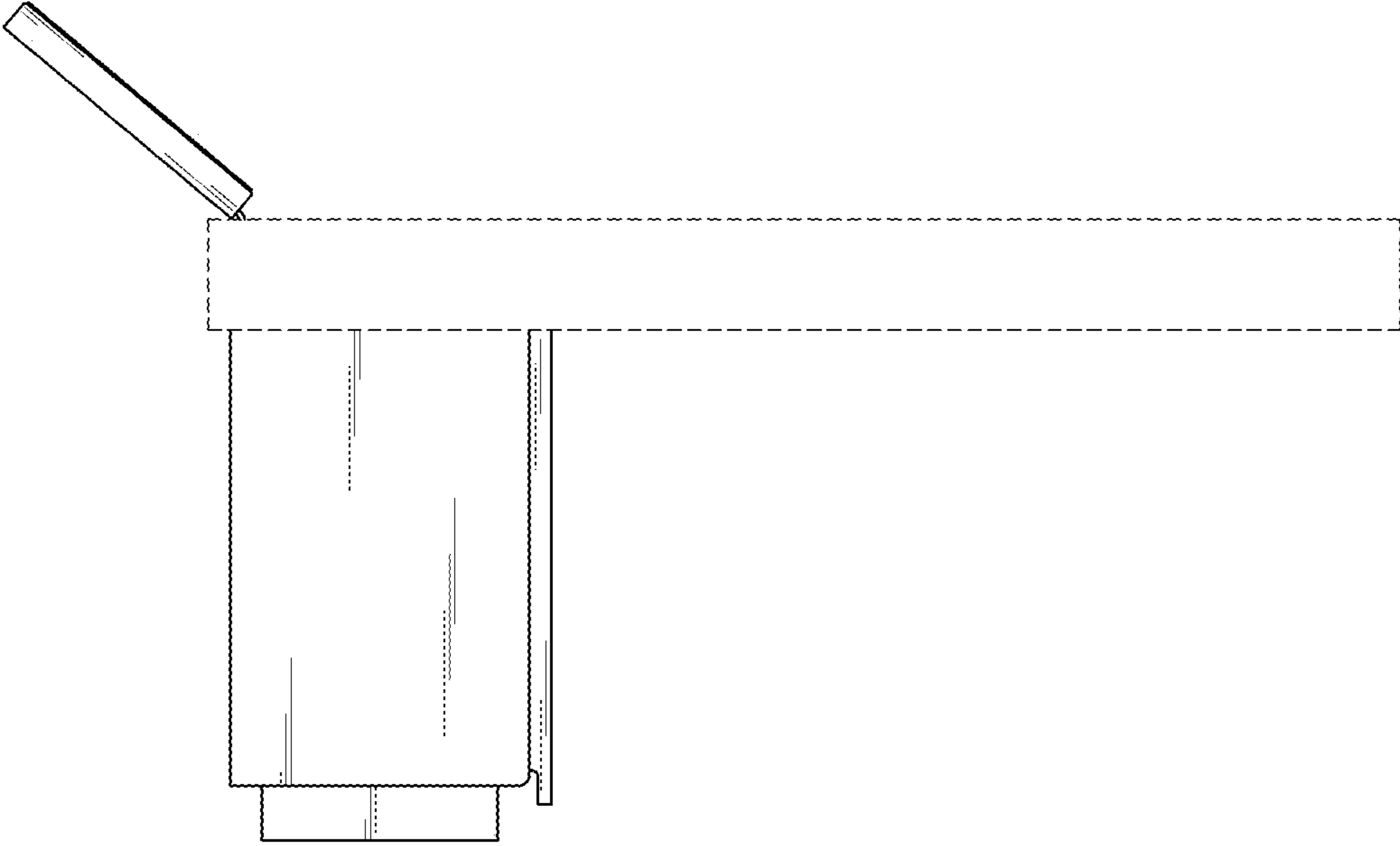

FIG. 9

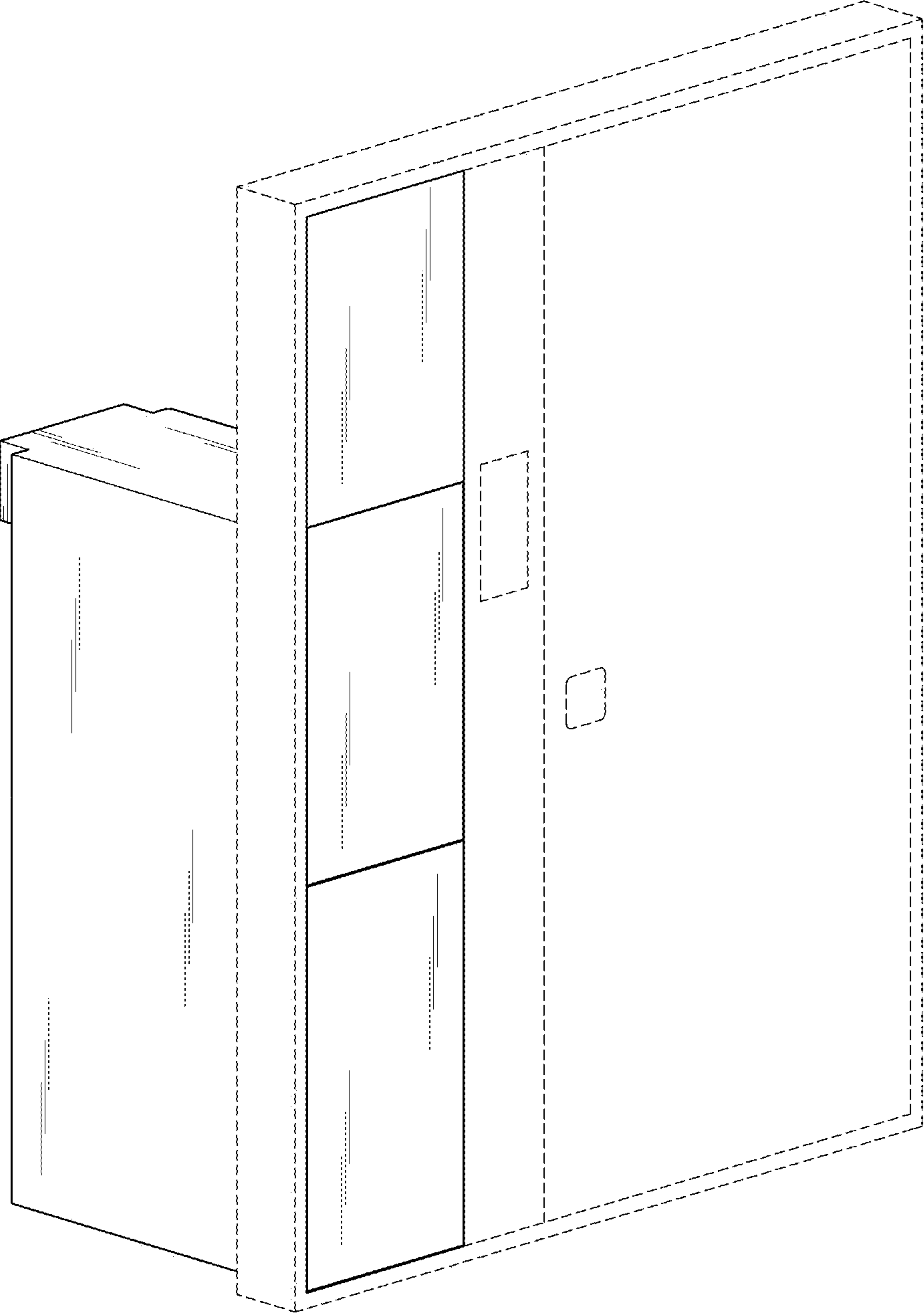

FIG. 10

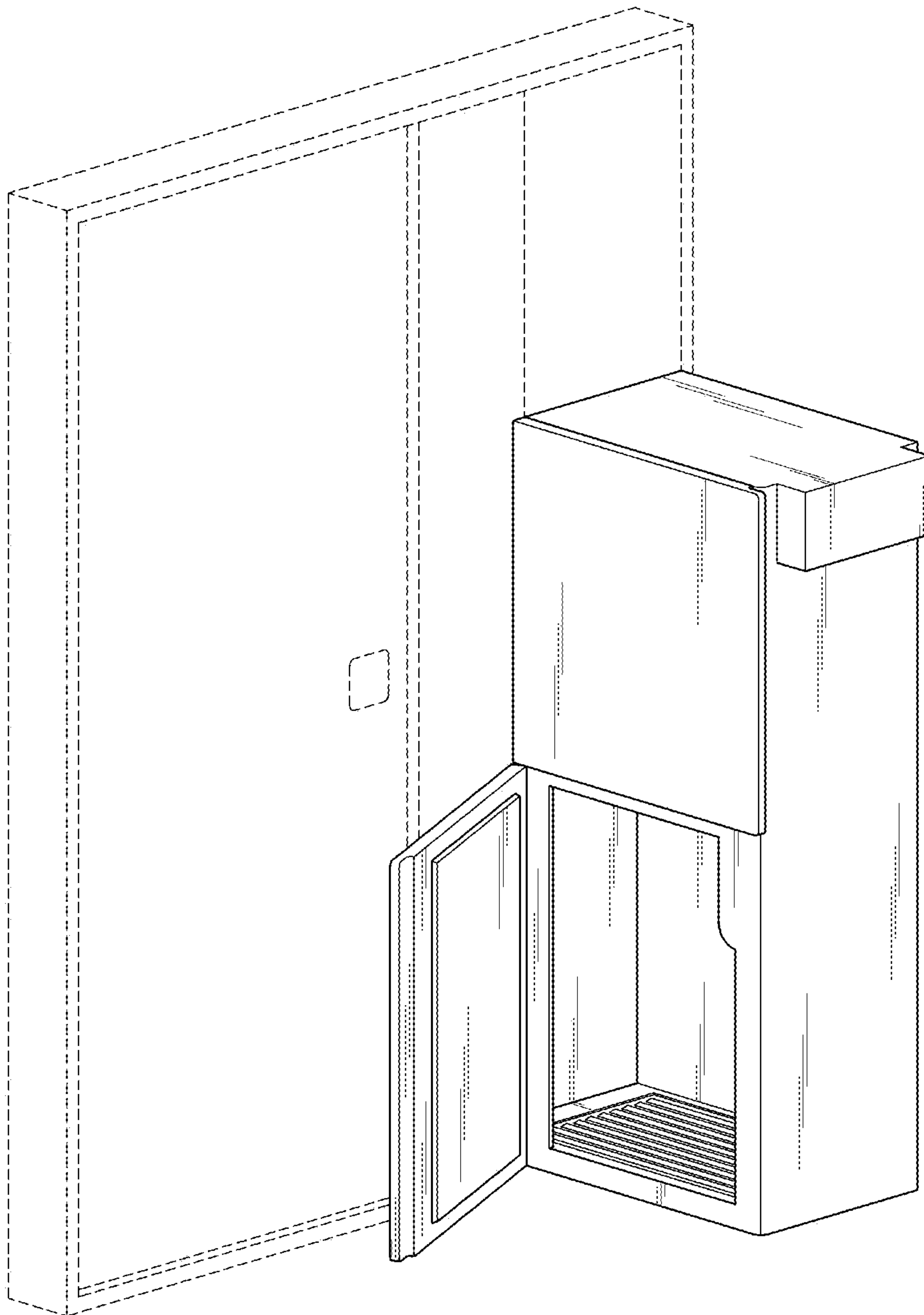

FIG. 11

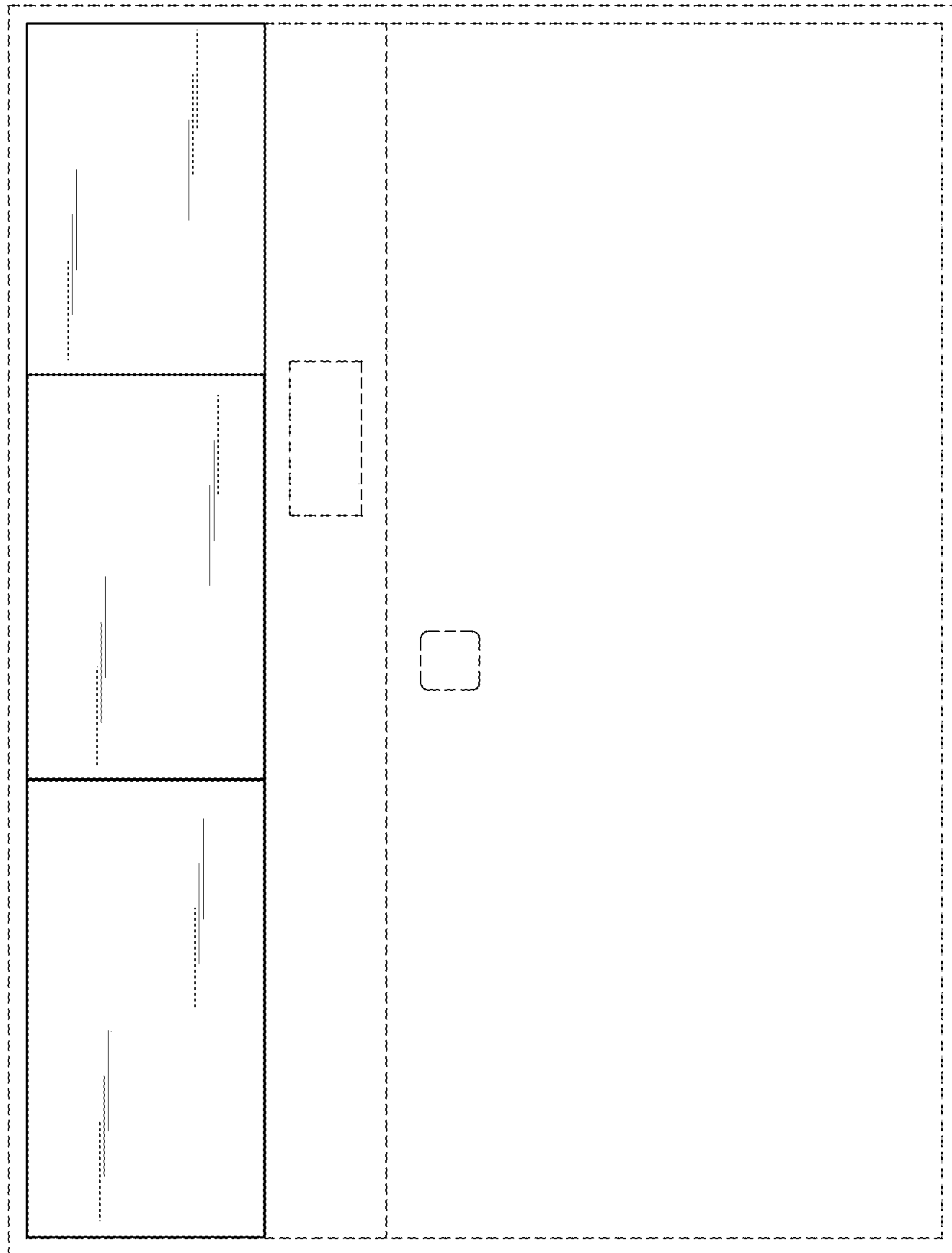

FIG. 12

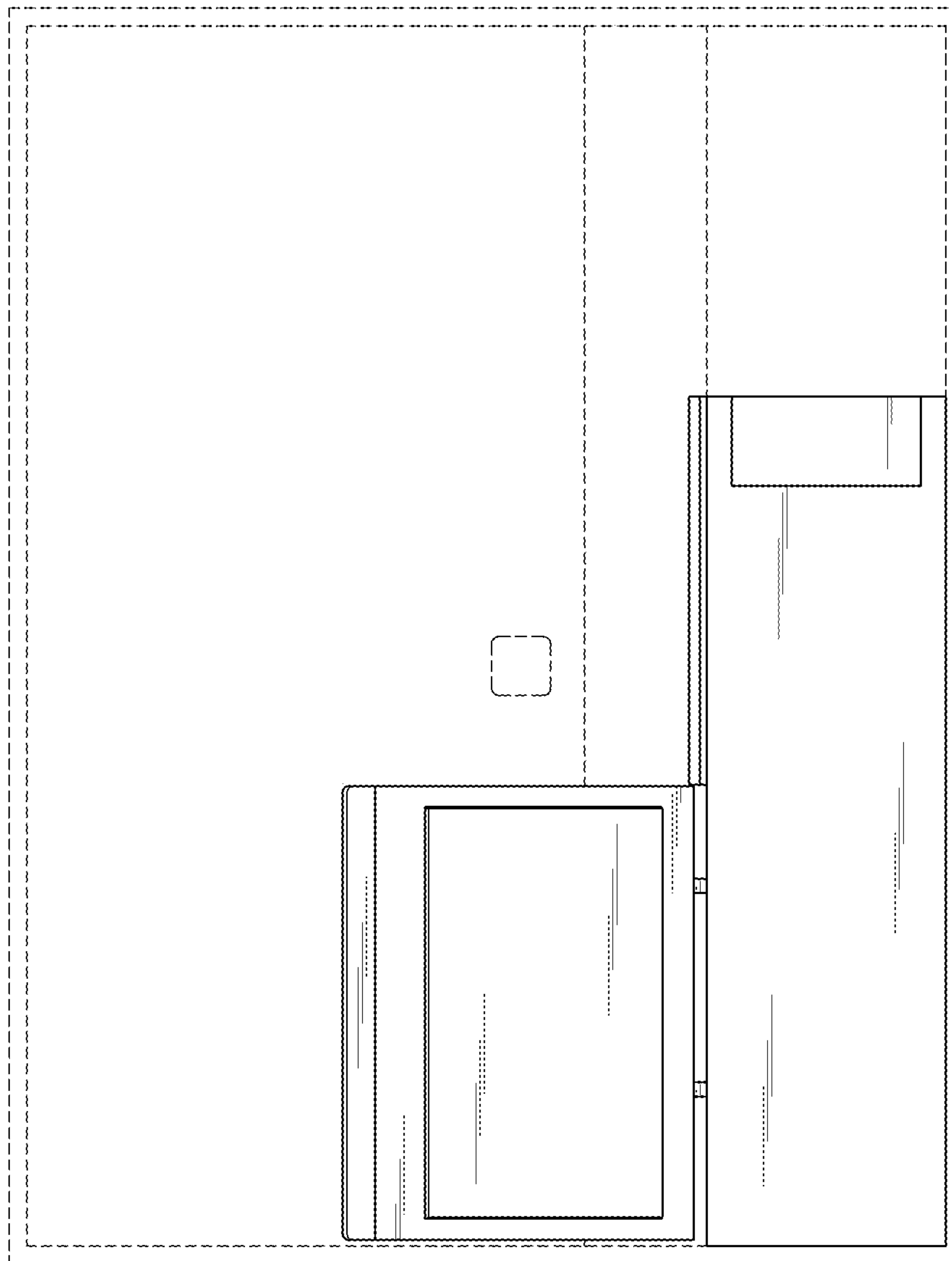

FIG. 13

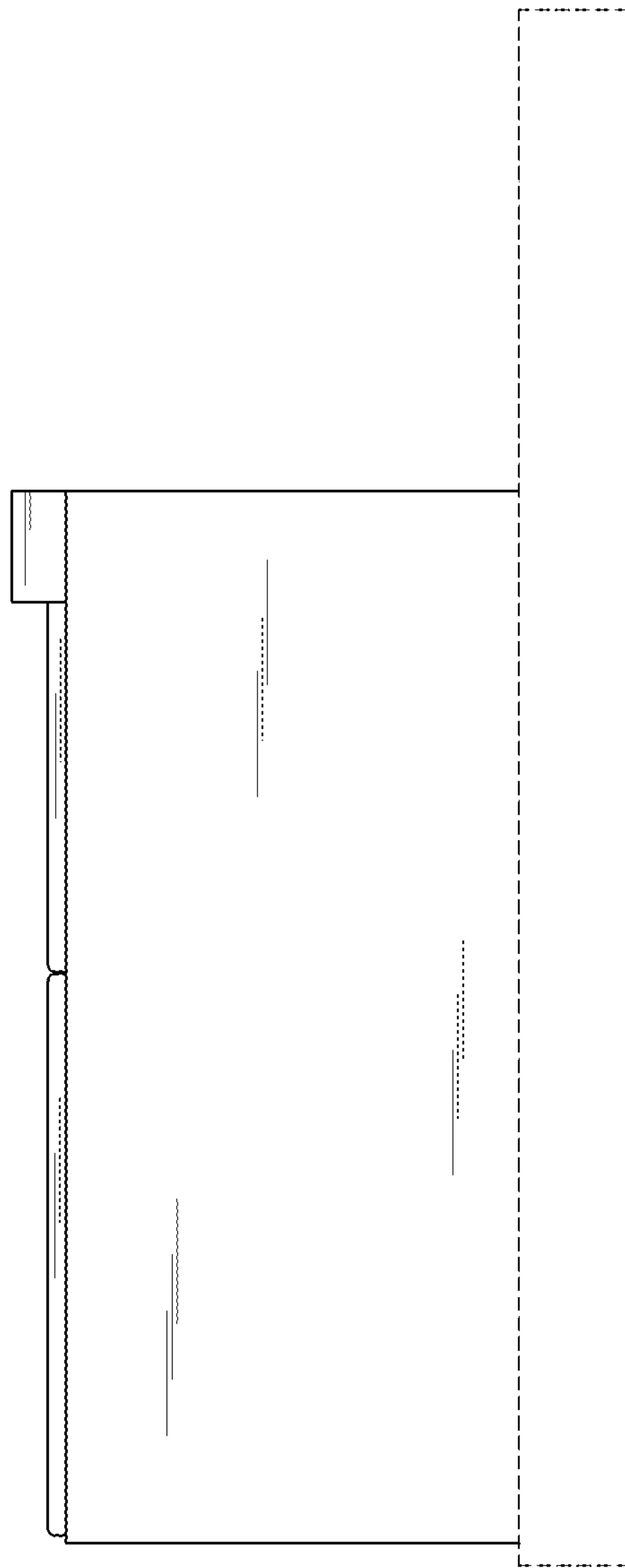

FIG. 14

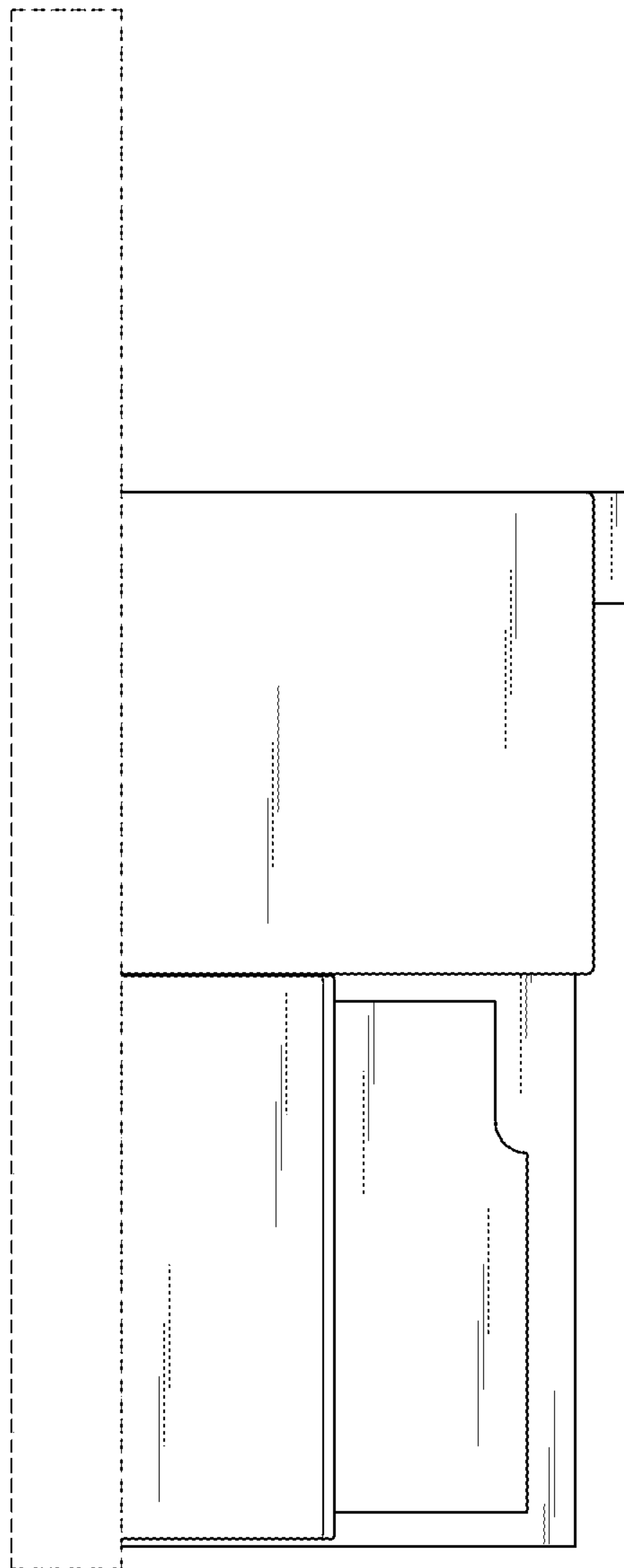

FIG. 15

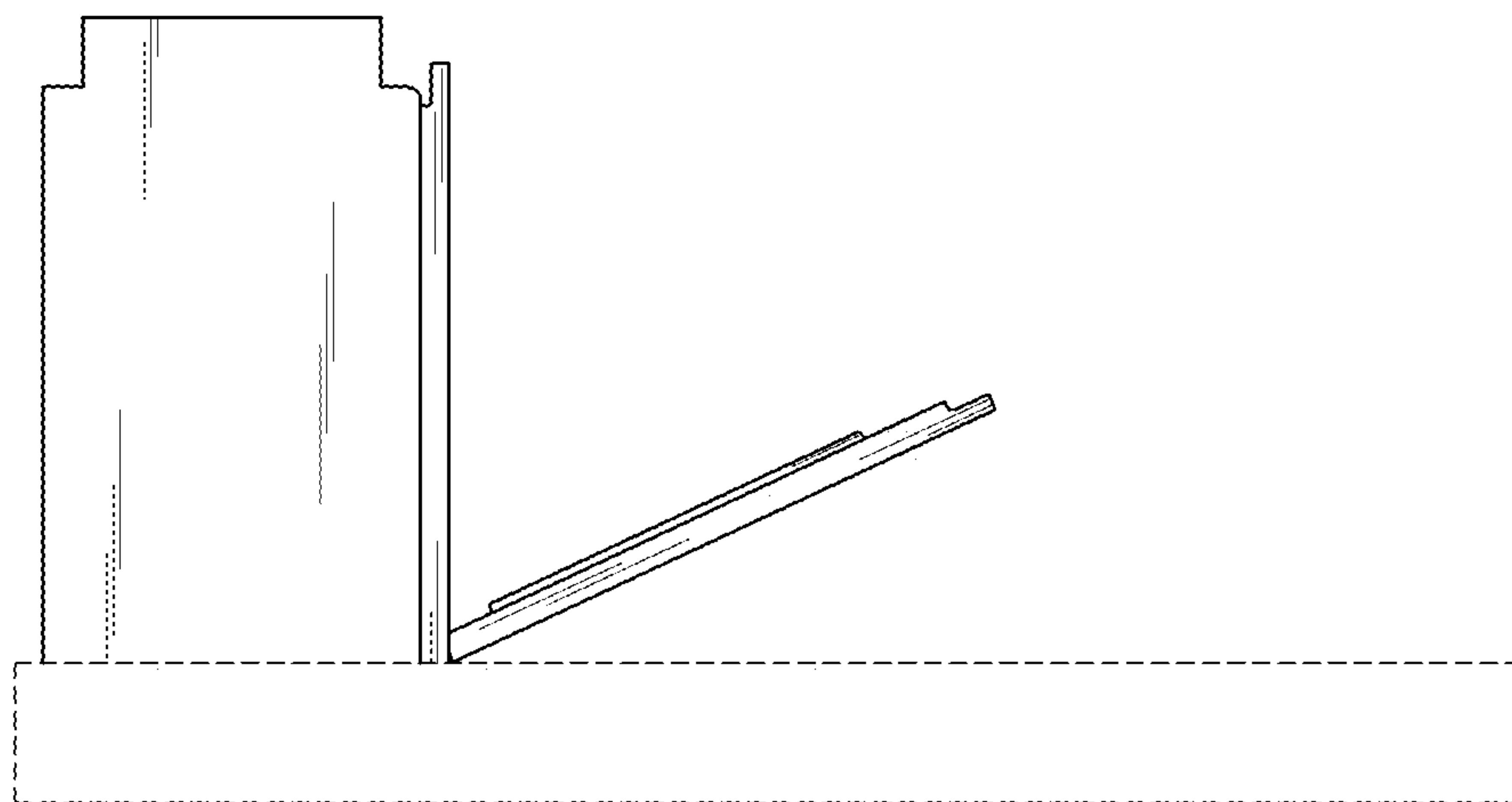

FIG. 16

