



US00D962869S

(12) **United States Design Patent** (10) **Patent No.:** **US D962,869 S**
Ohtani et al. (45) **Date of Patent:** **** Sep. 6, 2022**

(54) **RESISTOR**
(71) Applicant: **MITUTOYO CORPORATION**,
Kanagawa (JP)
(72) Inventors: **Shigeru Ohtani**, Kawasaki (JP);
Takayuki Yonezawa, Tokyo (JP); **Rie**
Arai, Kawasaki (JP); **Motohiro Osaki**,
Tokyo (JP)

3,511,951 A * 5/1970 Miller H01H 13/08
200/5 E
3,582,860 A * 6/1971 Milovac H01C 10/40
338/183
3,868,621 A * 2/1975 Kitamura H01C 10/38
338/180
D254,186 S * 2/1980 Collett D13/125
(Continued)

(73) Assignee: **MITUTOYO CORPORATION**,
Kawasaki (JP)

Mitutoyo, Date: Nov. 2021, [online], [site visited Mar. 17, 2022].
Available from internet, URL: <https://www.mitutoyo.com/products/sensor-systems/> (Year: 2021).*

(**) Term: **15 Years**

(Continued)

(21) Appl. No.: **29/737,944**

Primary Examiner — Shawn T Gingrich

Assistant Examiner — Bryan N. Melvin

(22) Filed: **Jun. 12, 2020**

(74) *Attorney, Agent, or Firm* — Oliff PLC

(30) **Foreign Application Priority Data**

Dec. 13, 2019 (JP) 2019-027690

(51) **LOC (13) Cl.** **13-03**

(52) **U.S. Cl.**
USPC **D13/125; D13/158**

(58) **Field of Classification Search**
USPC D8/356, 360; D10/46, 70, 74; D13/103,
D13/107-108, 123, 125, 152, 158, 160,
D13/161, 162, 162.1, 168, 171, 184, 199;
D14/140, 140.6, 299, 301, 357-358, 433,
D14/439; D15/199; D16/218; D23/411;
D34/35

CPC G01B 5/12; H01C 10/38; H01C 10/40;
H01C 10/44; H01H 13/08; H01H 13/6395
See application file for complete search history.

(56) **References Cited**

U.S. PATENT DOCUMENTS

D180,830 S * 8/1957 Hoffstein D13/168
2,909,750 A * 10/1959 Pitzer H01C 10/44
338/133

(57) **CLAIM**

The ornamental design for a resistor, as shown and described.

DESCRIPTION

FIG. 1 is a front, left-side, top perspective view of the resistor;
FIG. 2 is a front elevational view thereof;
FIG. 3 is a rear elevational view thereof;
FIG. 4 is a left-side elevational view thereof;
FIG. 5 is a right-side elevational view thereof;
FIG. 6 is a top plan view thereof;
FIG. 7 is a bottom plan view thereof;
FIG. 8 is a rear, right-side, bottom perspective view thereof;
and,
FIG. 9 is a reference view showing the resistor in a state of use.

The broken lines in the drawings illustrate environment and portions of the resistor that form no part of the claimed design.

1 Claim, 5 Drawing Sheets

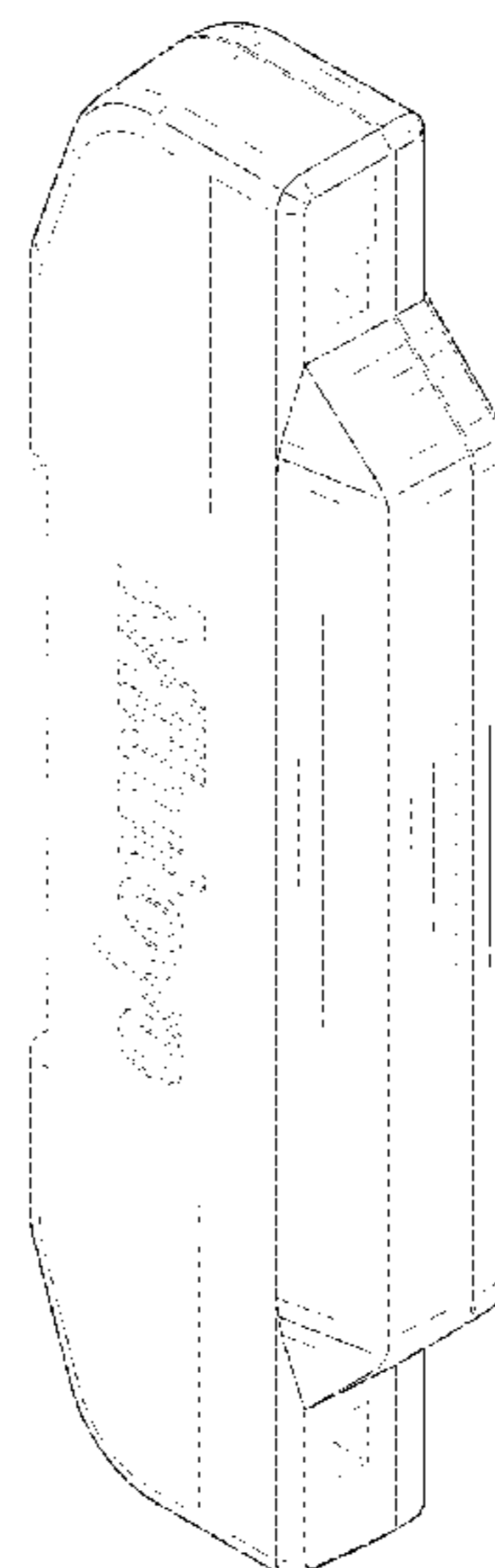

(56)

References Cited

U.S. PATENT DOCUMENTS

5,746,003 A * 5/1998 Baruchello G01B 5/12
33/542
D413,866 S * 9/1999 Suzuki D13/158
6,475,036 B2 * 11/2002 Morikawa H01R 13/6395
439/716
D653,624 S * 2/2012 Mattlar D13/158
D807,733 S * 1/2018 Fretz D8/356
D818,443 S * 5/2018 Belver Garcia D13/160
D865,940 S * 11/2019 Beaman D23/411

OTHER PUBLICATIONS

Businesswire, Date: Apr. 27, 2021, [online], [site visited Mar. 17, 2022]. Available from internet, URL: <https://www.businesswire.com/news/home/20210427005007/en/Mitutoyo-America-Corporation-Introduces-New-EJ-Counters-and-LG100-Series-Linear-Gages-to-Sensor-Line> (Year: 2021).*

MMS, dated May 10, 2021, [online], [site visited Mar. 17, 2022]. Available from internet, URL: <https://www.mmsonline.com/products/mitutoyo-launches-ej-counters-lg100-linear-gages> (Year: 2021).*

CC-Link Interface Unit Main Module MG50-CL. Magnescale Co., Ltd. 2018. https://www.hegewald-peschke.de/fileadmin/daten/_magnescale/PIT_MGSE5.1/MG50-CL_MG51_en.pdf.

Contact-Type Digital Displacement Sensor HG-S Series. pp. 1093-1110. https://www3.panasonic.biz/ac/e_download/fasys/measurement/measurement/catalog/hg-s_e_cata.pdf?f_cd=402219.

* cited by examiner

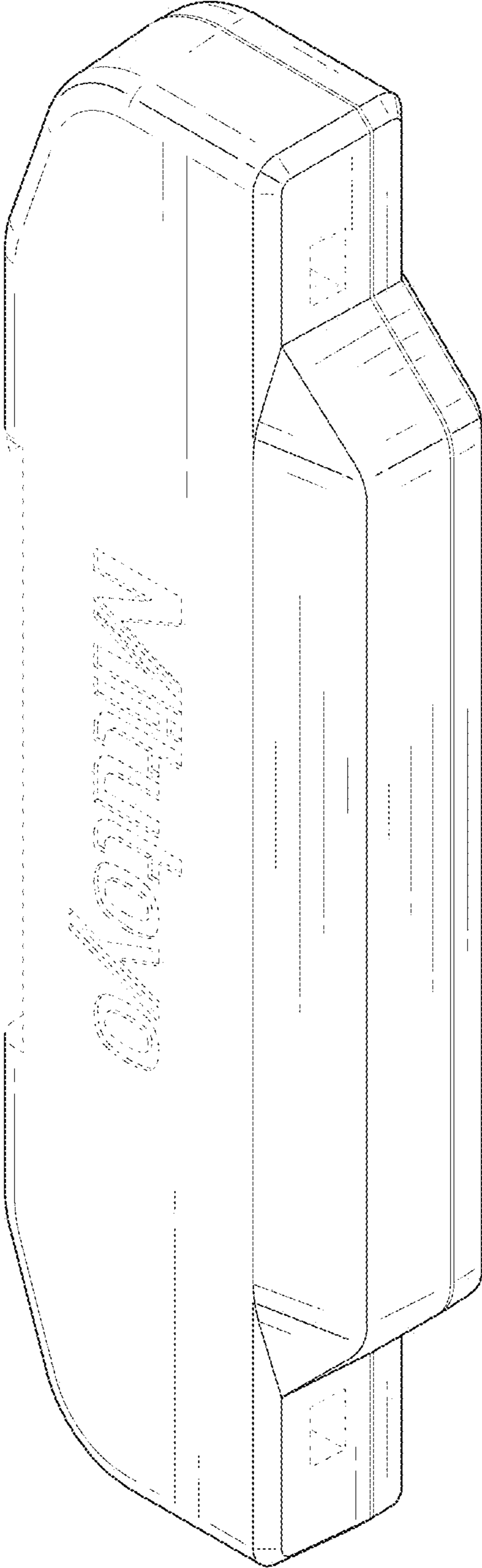

FIG. 1

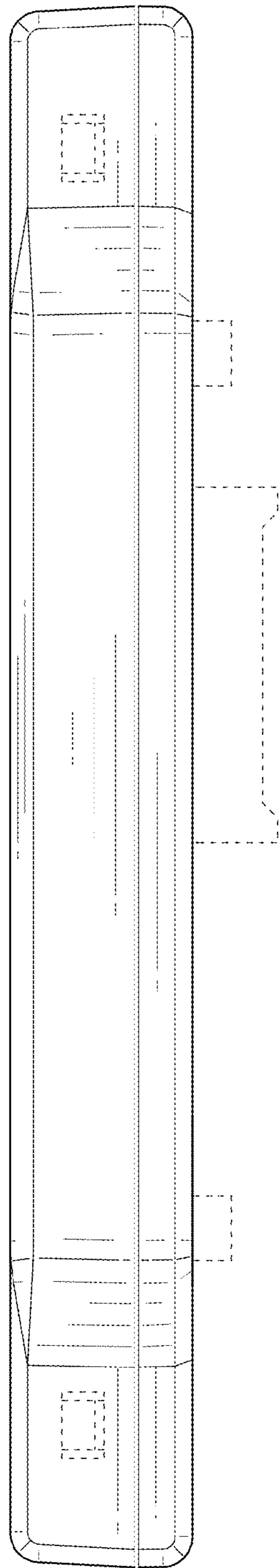

FIG. 2

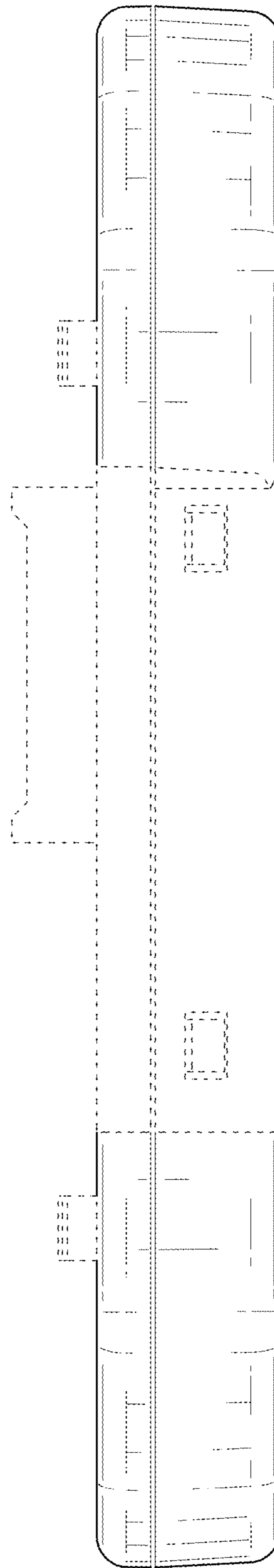

FIG. 3

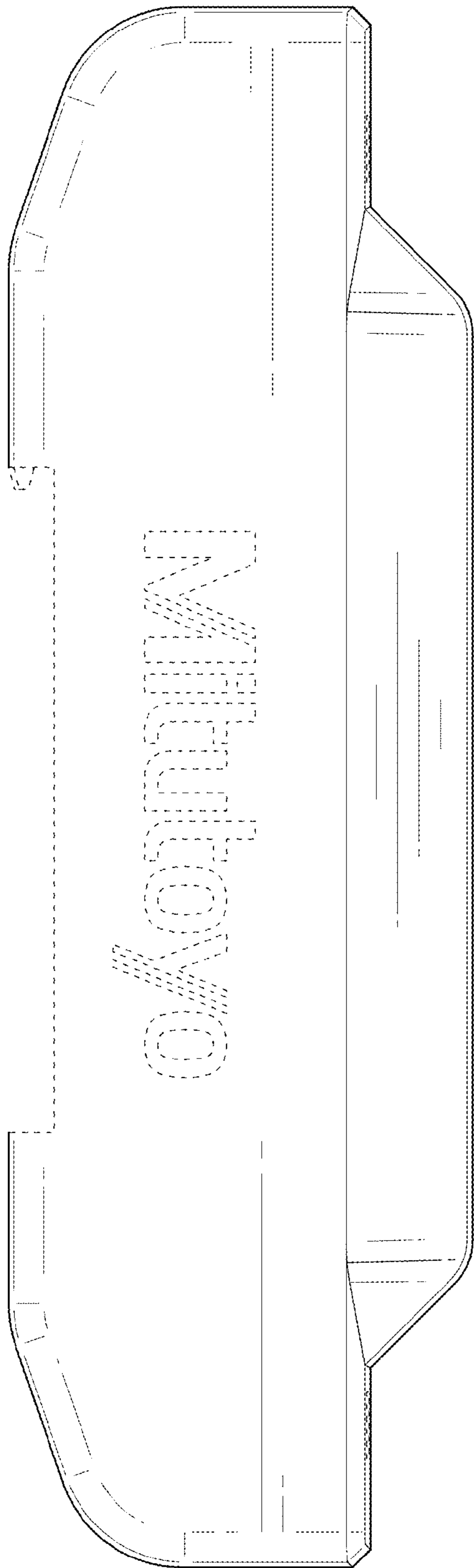

FIG. 4

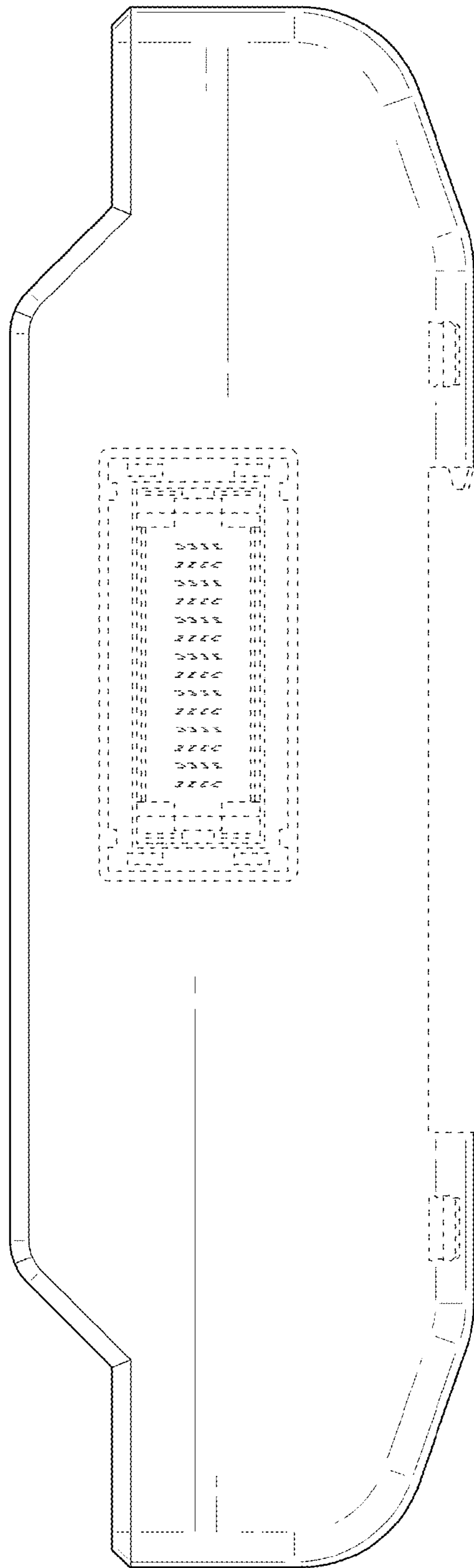

FIG. 5

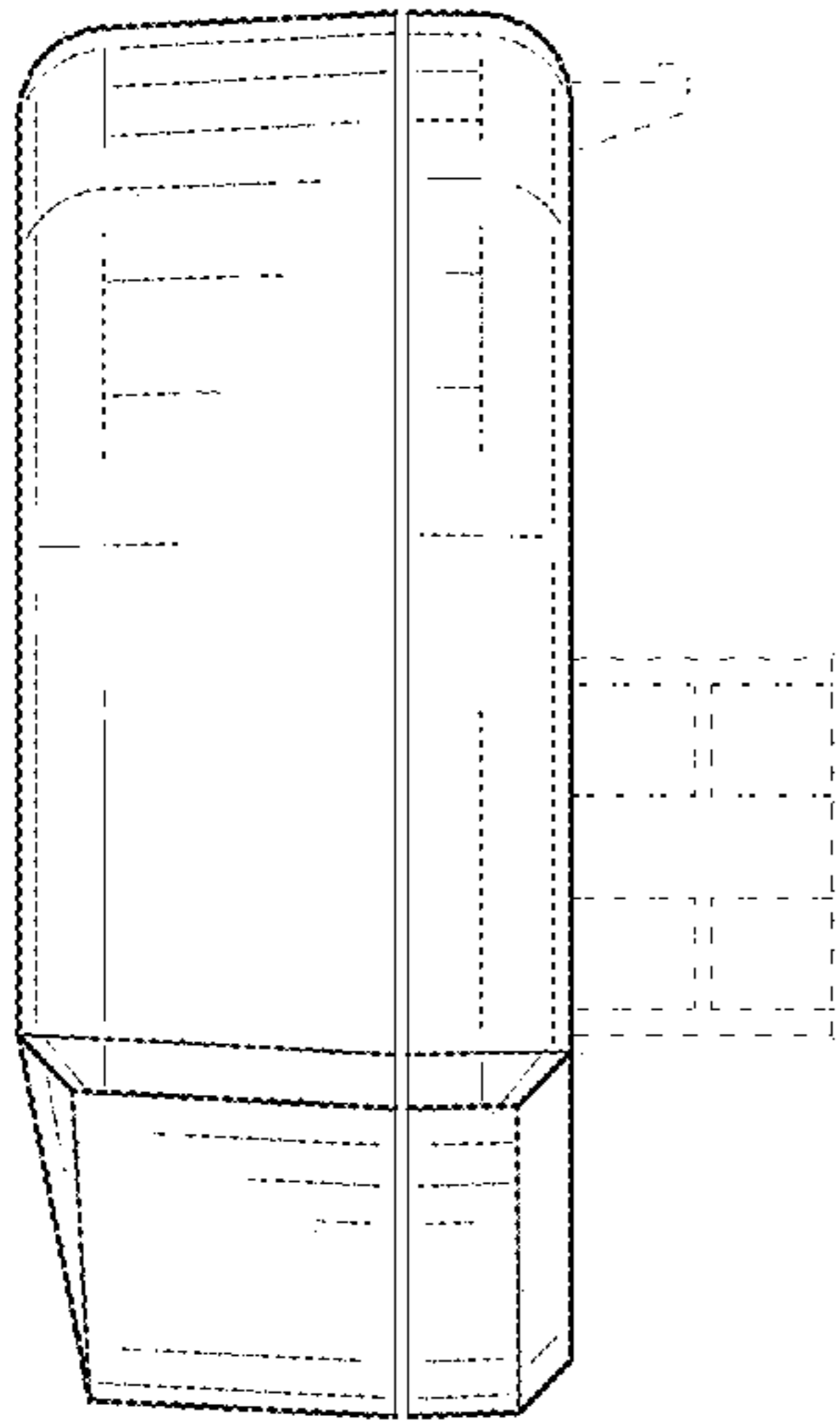

FIG. 6

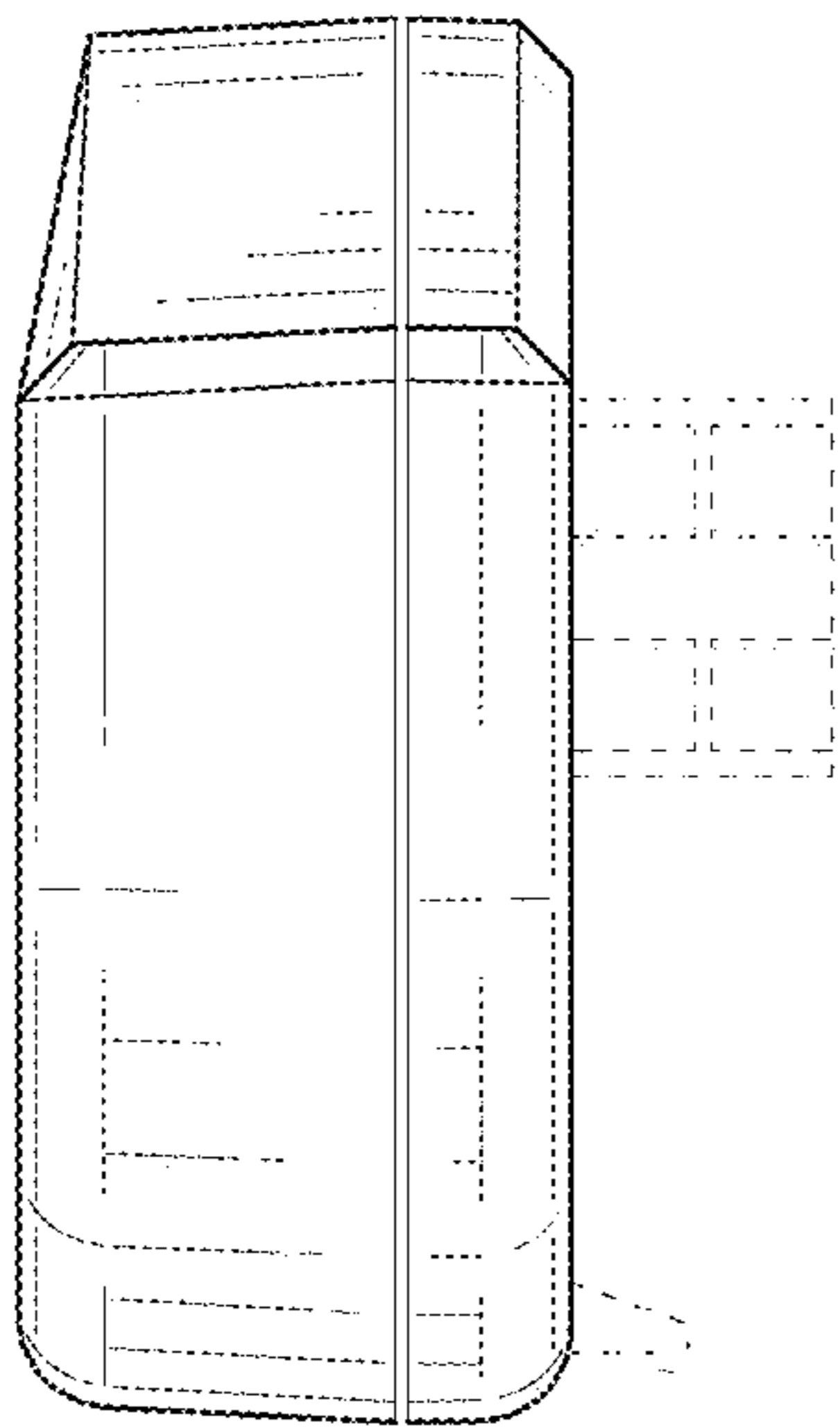

FIG. 7

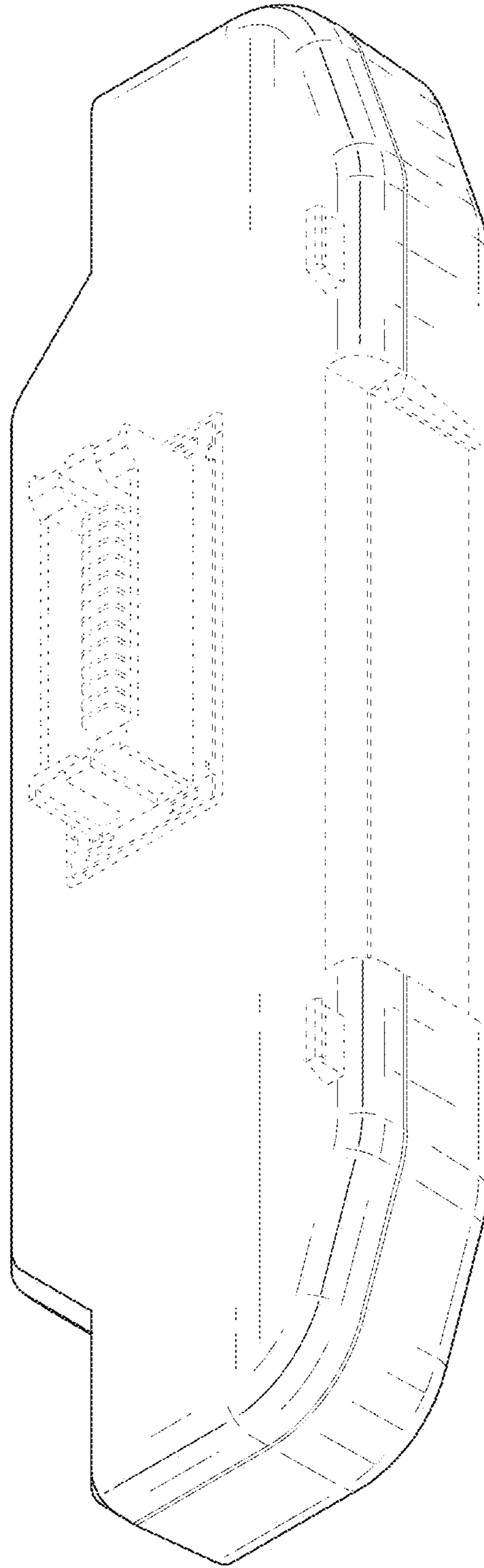

FIG. 8

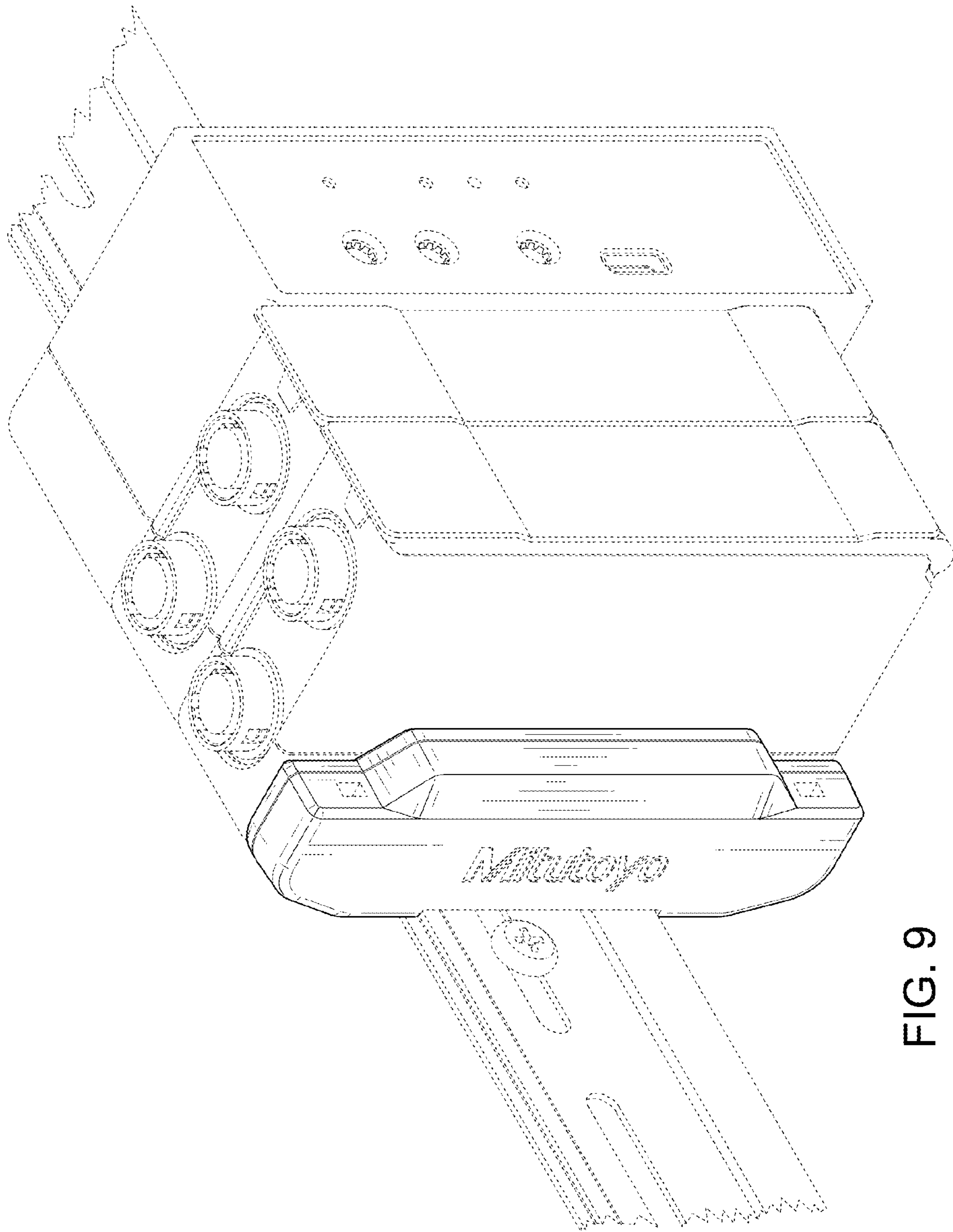

FIG. 9