

US00D962824S

(12) **United States Design Patent** (10) **Patent No.:** **US D962,824 S**
Li (45) **Date of Patent:** **** Sep. 6, 2022**

(54) **MOTOR VEHICLE, TOY REPLICA, AND/OR OTHER REPLICA**

Primary Examiner — Melody N Brown
(74) *Attorney, Agent, or Firm* — Crowell & Moring LLP

(71) Applicant: **Bayerische Motoren Werke Aktiengesellschaft, Munich (DE)**

(57) **CLAIM**

(72) Inventor: **Tianyuan Li, Munich (DE)**

The ornamental design for a motor vehicle, toy replica and/or other replica, as shown and described.

(73) Assignee: **Bayerische Motoren Werke Aktiengesellschaft, Munich (DE)**

DESCRIPTION

(**) Term: **15 Years**

This application contains subject matter related to the following co-pending U.S. design patent applications: Application Ser. No. 29/765,981, filed herewith and entitled "Hood for a Vehicle"; Application Ser. No. 29/765,982, filed herewith and entitled "Front Bumper for a Vehicle"; Application Ser. No. 29/765,983, filed herewith and entitled "Front Fender for a Vehicle"; Application Ser. No. 29/765,984, filed herewith and entitled "Rear Fender for a Vehicle"; Application Ser. No. 29/765,985, filed herewith and entitled "Rear Bumper for a Vehicle"; Application Ser. No. 29/765,986, filed herewith and entitled "Tailgate for a Vehicle"; Application Ser. No. 29/765,987, filed herewith and entitled "Radiator Grille for a Vehicle"; Application Ser. No. 29/765,988, filed herewith and entitled "Side Mirror for a Vehicle"; Application Ser. No. 29/765,991, filed herewith and entitled "Headlight for a Vehicle"; and Application Ser. No. 29/765,993, filed herewith and entitled "Taillight for a Vehicle".

(21) Appl. No.: **29/765,980**

(22) Filed: **Jan. 13, 2021**

(30) **Foreign Application Priority Data**

Jul. 21, 2020 (DE) 402020100678.5

(51) **LOC (13) Cl.** **12-08**

(52) **U.S. Cl.**
USPC **D12/91**

(58) **Field of Classification Search**
USPC D12/86, 90–92, 164; D21/424, 433, 434;
296/181.1–181.5, 183.1
CPC B62D 25/00; B62D 25/06; B62D 33/00;
B62D 35/00
See application file for complete search history.

(56) **References Cited**

U.S. PATENT DOCUMENTS

D714,190 S	9/2014	Kim	
D796,999 S	9/2017	Klimov	
D813,726 S *	3/2018	Tanghe	D12/91
D813,727 S *	3/2018	Beermann	D12/92
D821,919 S *	7/2018	Simm	D12/91
D825,383 S *	8/2018	Luk	D12/91

(Continued)

FOREIGN PATENT DOCUMENTS

EM 001898289-0001 9/2011

1 Claim, 7 Drawing Sheets

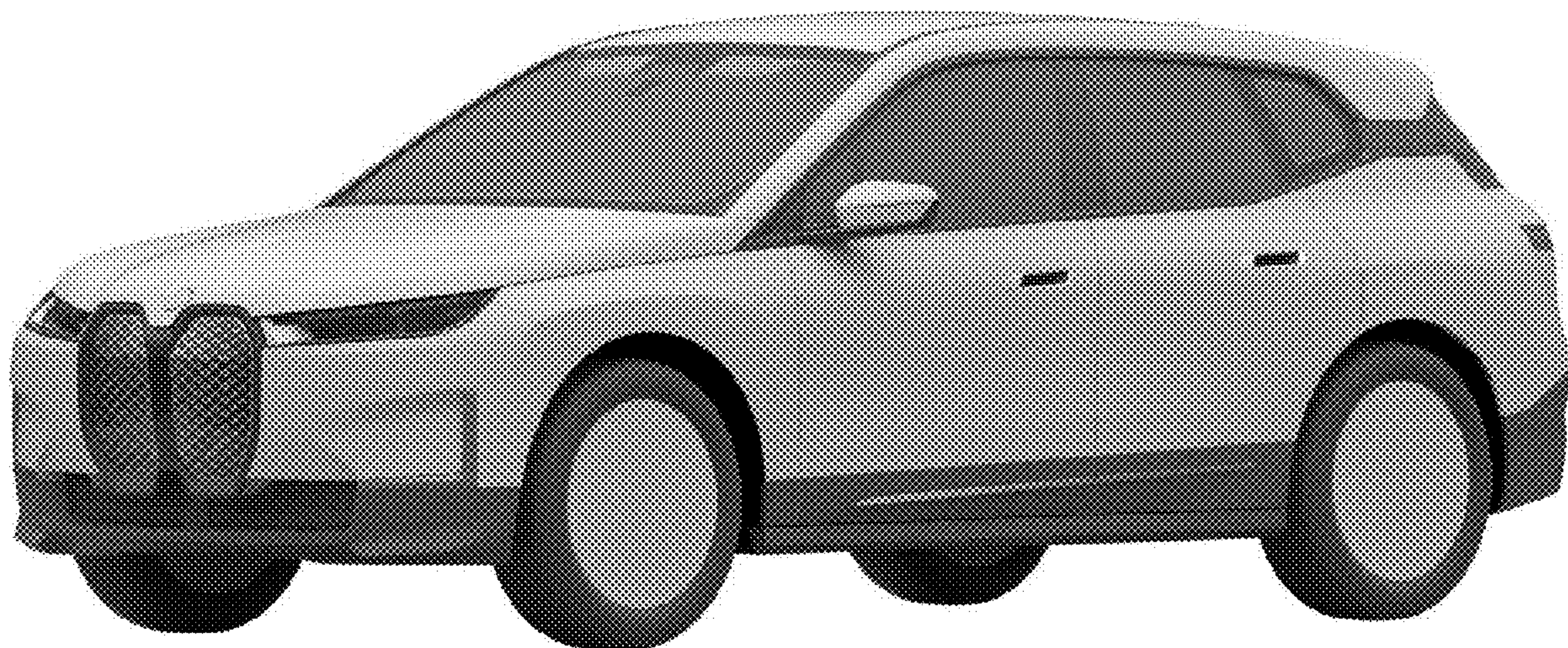

(56)

References Cited

U.S. PATENT DOCUMENTS

D825,390	S	*	8/2018	Al Attar	D12/92
D831,540	S	*	10/2018	Buckingham	D12/92
D835,546	S	*	12/2018	Sarreméjean	D12/91
D845,834	S	*	4/2019	Sarreméjean	D12/91
D855,496	S	*	8/2019	Thogersen	D12/91
D860,053	S	*	9/2019	Forschner	D12/92
D871,260	S	*	12/2019	Karras	D12/91
D881,756	S		4/2020	Pena	
D892,682	S	*	8/2020	Simm	D12/91
D928,660	S	*	8/2021	Lim	D12/92

* cited by examiner

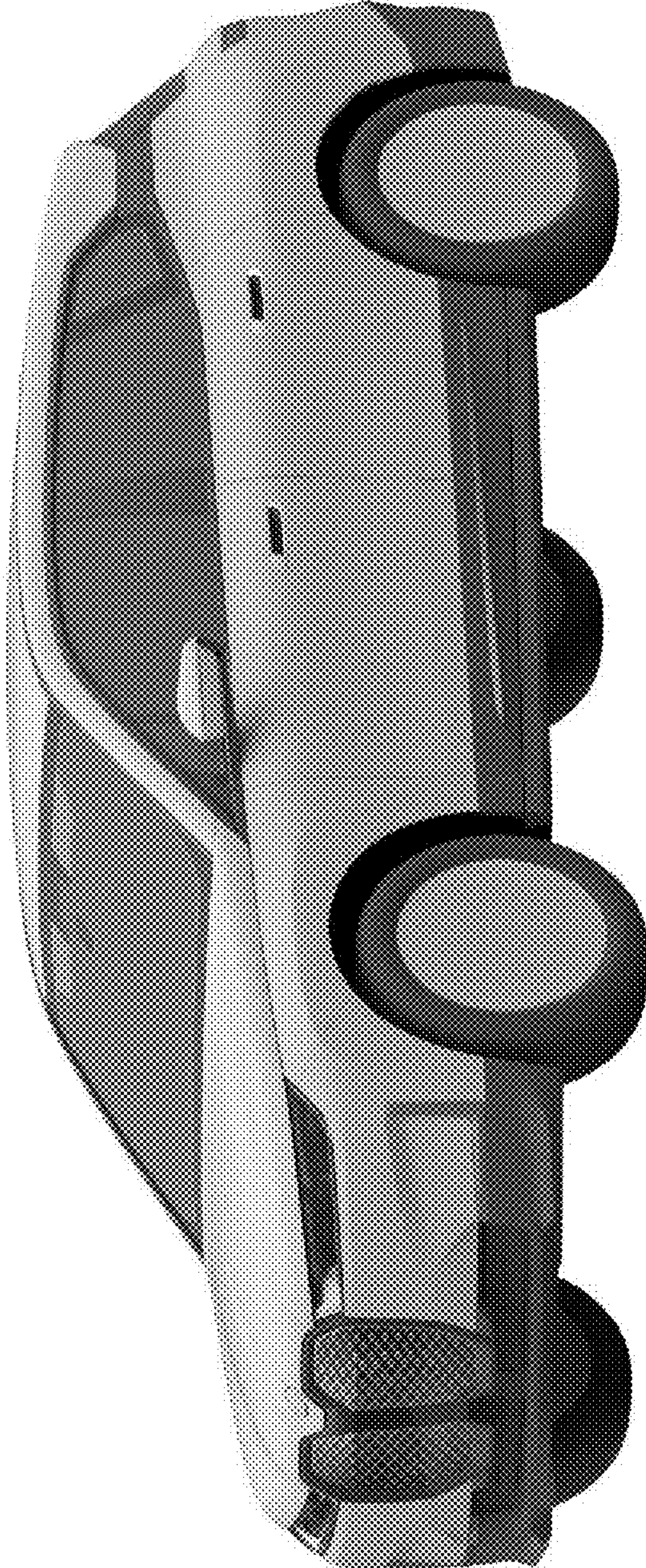

Fig. 1

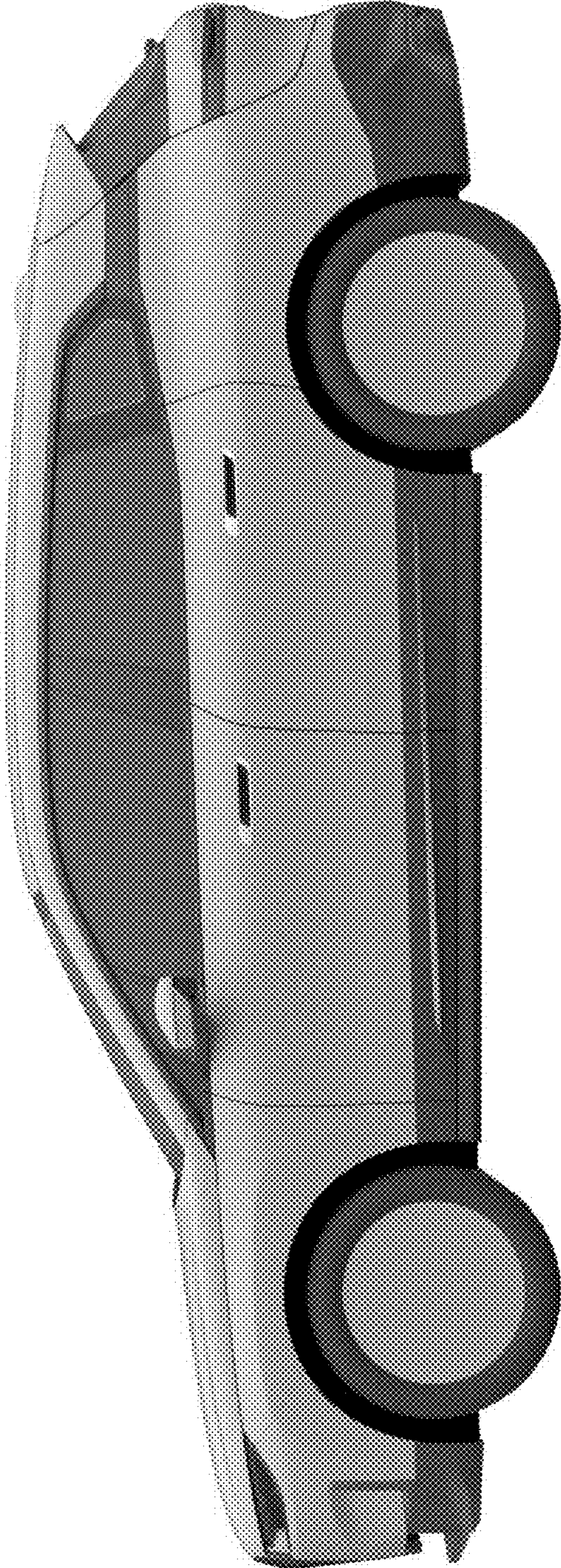

Fig. 2

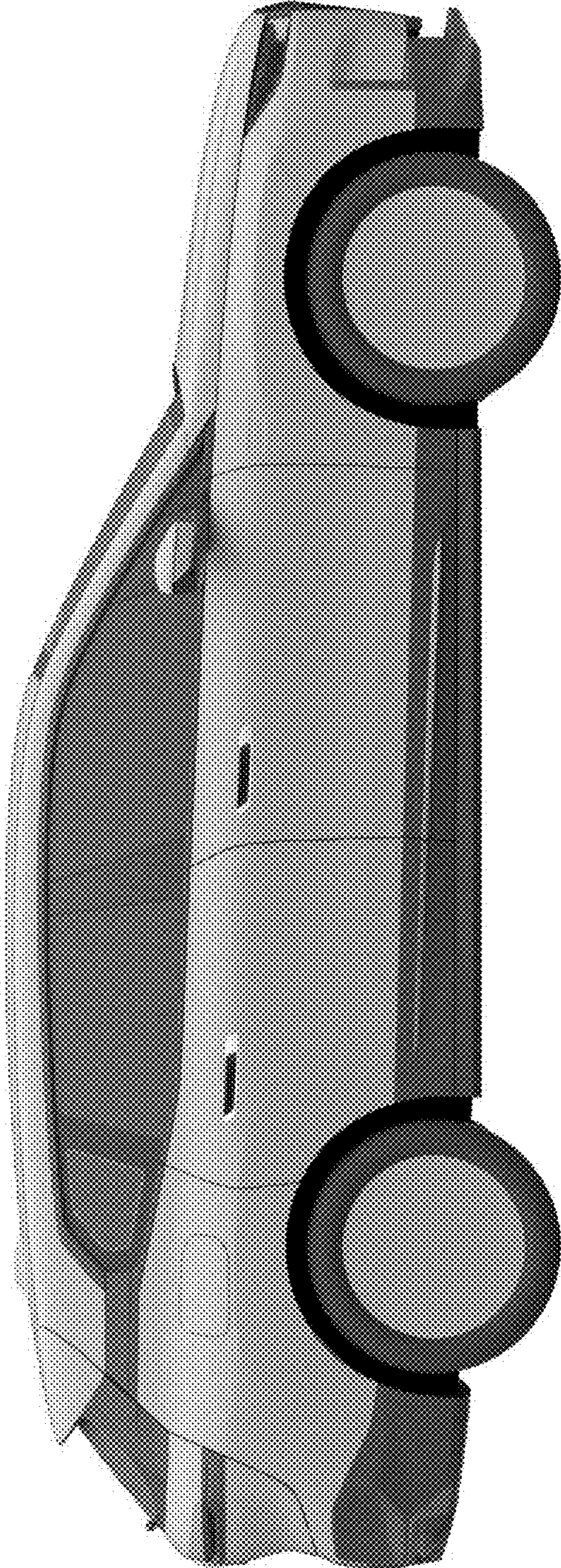

Fig. 3

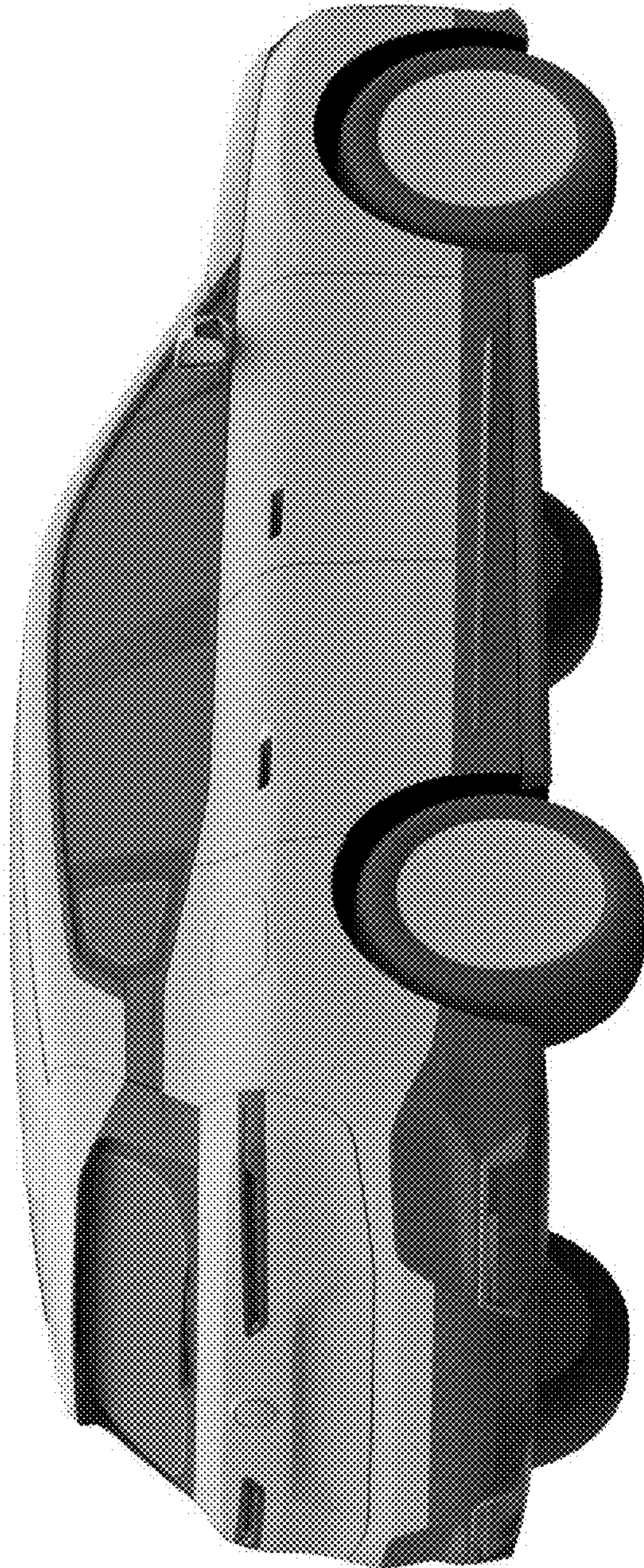

Fig. 4

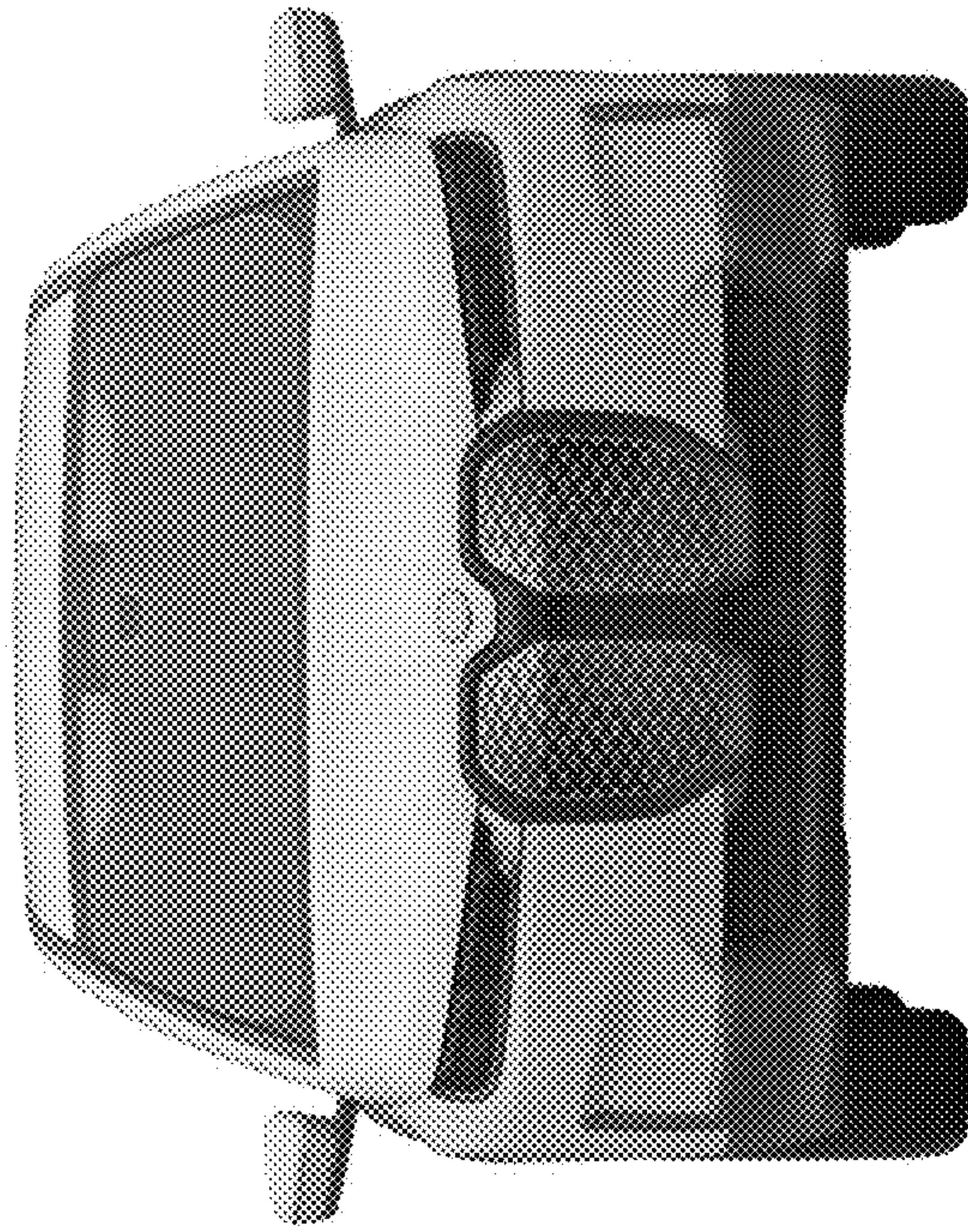

Fig. 5

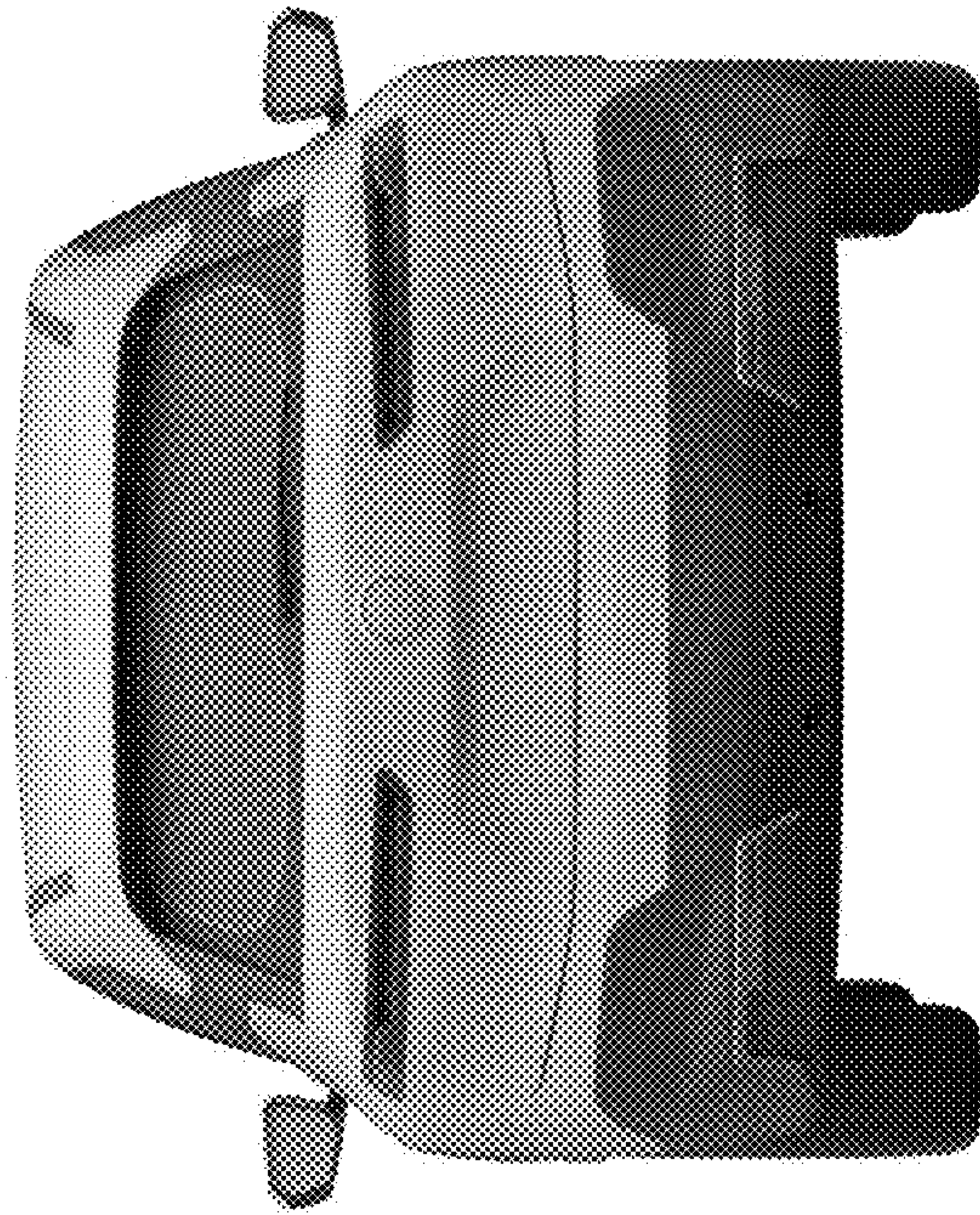

Fig. 6

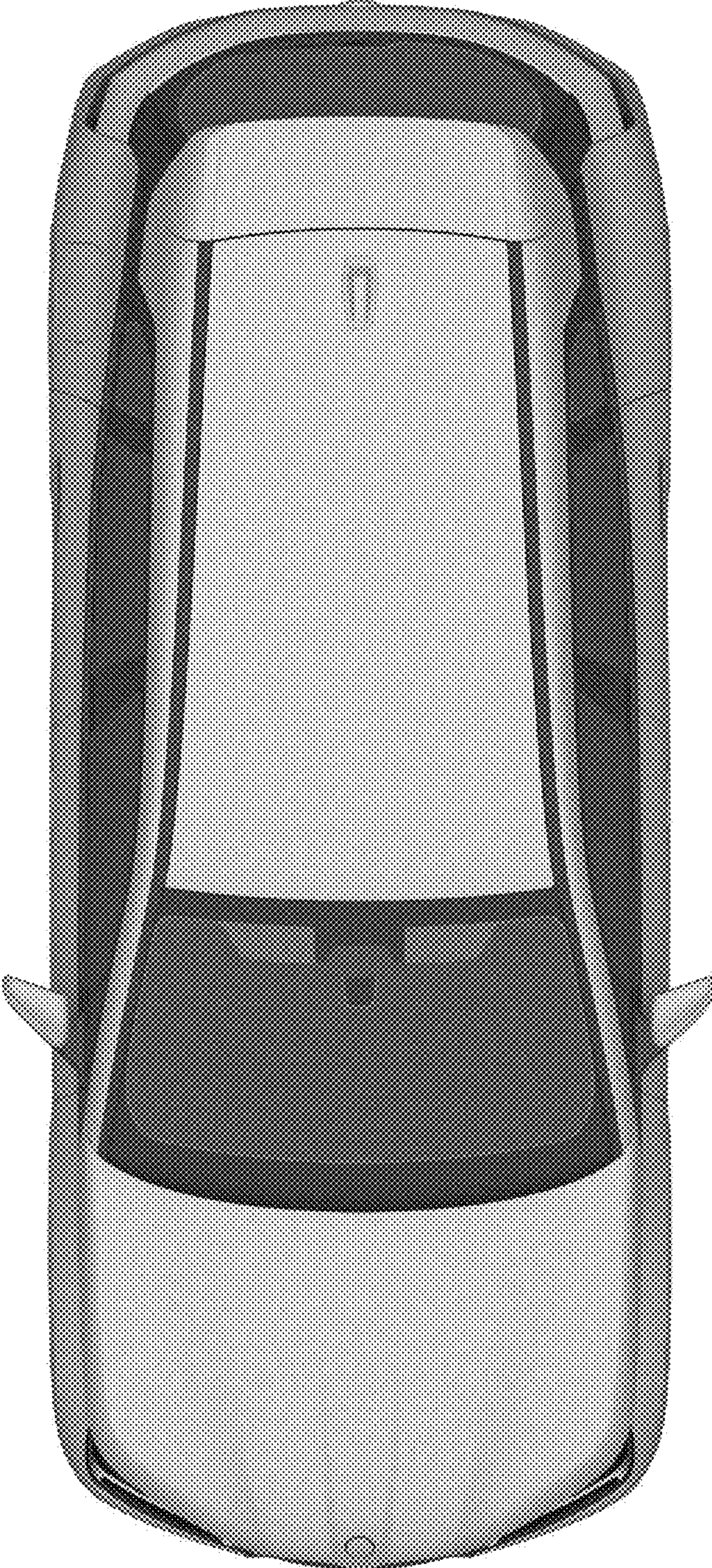

Fig. 7