

US00D962820S

(12) **United States Design Patent**
Guillory et al.

(10) **Patent No.:** **US D962,820 S**
(45) **Date of Patent:** **** Sep. 6, 2022**

(54) **FLAMINGO LAWN ORNAMENT**

DESCRIPTION

(71) Applicant: **ATT Southern LLC**, Atlanta, GA (US)

(72) Inventors: **Patrick Guillory**, Smyrna, GA (US);
Chun Hung, Dillsburg, PA (US);
Robert Stein, Atlanta, GA (US); **Amy Brinckerhoff**, Marietta, GA (US)

(73) Assignee: **ATT Southern LLC**, Atlanta, GA (US)

(**) Term: **15 Years**

(21) Appl. No.: **29/741,196**

(22) Filed: **Jul. 10, 2020**

(51) **LOC (13) Cl.** **11-02**

(52) **U.S. Cl.**
USPC **D11/162**

(58) **Field of Classification Search**
USPC D11/127, 131, 134, 137, 141, 157, 158,
D11/162, 57, 58, 107, 149;

(Continued)

(56) **References Cited**

U.S. PATENT DOCUMENTS

D301,992 S * 7/1989 Zumwalt D11/158
D392,917 S * 3/1998 Cliff D11/131

(Continued)

OTHER PUBLICATIONS

Bloem Pink Flamingo Garden Yard Statue, available Jun. 19, 2018, [online], [site visited Dec. 4, 2021]. Available from internet, URL: <https://www.amazon.com/Bloem-BULK-G2-12-Flamingo-12-Pack/dp/B0032WFEFY/ref=> (Year: 2018).*

Primary Examiner — W. A. Teddy Falloway
(74) *Attorney, Agent, or Firm* — Brooks Kushman P.C.

(57) **CLAIM**

The ornamental design for a flamingo lawn ornament, as shown and described.

FIG. 1 is a top perspective view of a flamingo lawn ornament, shown in an opened configuration and without leg supports;

FIG. 2 is a top plan view of the flamingo lawn ornament of FIG. 1;

FIG. 3 is a front side elevation view of the flamingo lawn ornament of FIG. 1;

FIG. 4 is a left side elevation view of the flamingo lawn ornament of FIG. 1;

FIG. 5 is a right side elevation view of the flamingo lawn ornament of FIG. 1;

FIG. 6 is a rear side elevation view of the flamingo lawn ornament of FIG. 1;

FIG. 7 is a bottom view of the flamingo lawn ornament of FIG. 1;

FIG. 8 a bottom perspective view of the flamingo lawn ornament of FIG. 1;

FIG. 9 is a top perspective view of the flamingo lawn ornament of FIG. 1, but shown with leg supports;

FIG. 10 is a top plan view of the flamingo lawn ornament of FIG. 9;

FIG. 11 is a front side elevation view of the flamingo lawn ornament of FIG. 9;

FIG. 12 is a left side elevation view of the flamingo lawn ornament of FIG. 9;

FIG. 13 is a right side elevation view of the flamingo lawn ornament of FIG. 9;

FIG. 14 is a rear side elevation view of the flamingo lawn ornament of FIG. 9;

FIG. 15 is a bottom view of the flamingo lawn ornament of FIG. 9;

FIG. 16 a bottom perspective view of the flamingo lawn ornament of FIG. 9;

FIG. 17 is a front perspective view of the flamingo lawn ornament of FIG. 1, but shown in a closed configuration;

FIG. 18 is a top plan view of the flamingo lawn ornament of FIG. 17;

FIG. 19 is a right side elevation view of the flamingo lawn ornament of FIG. 17;

FIG. 20 is a front side elevation view of the flamingo lawn ornament of FIG. 17;

(Continued)

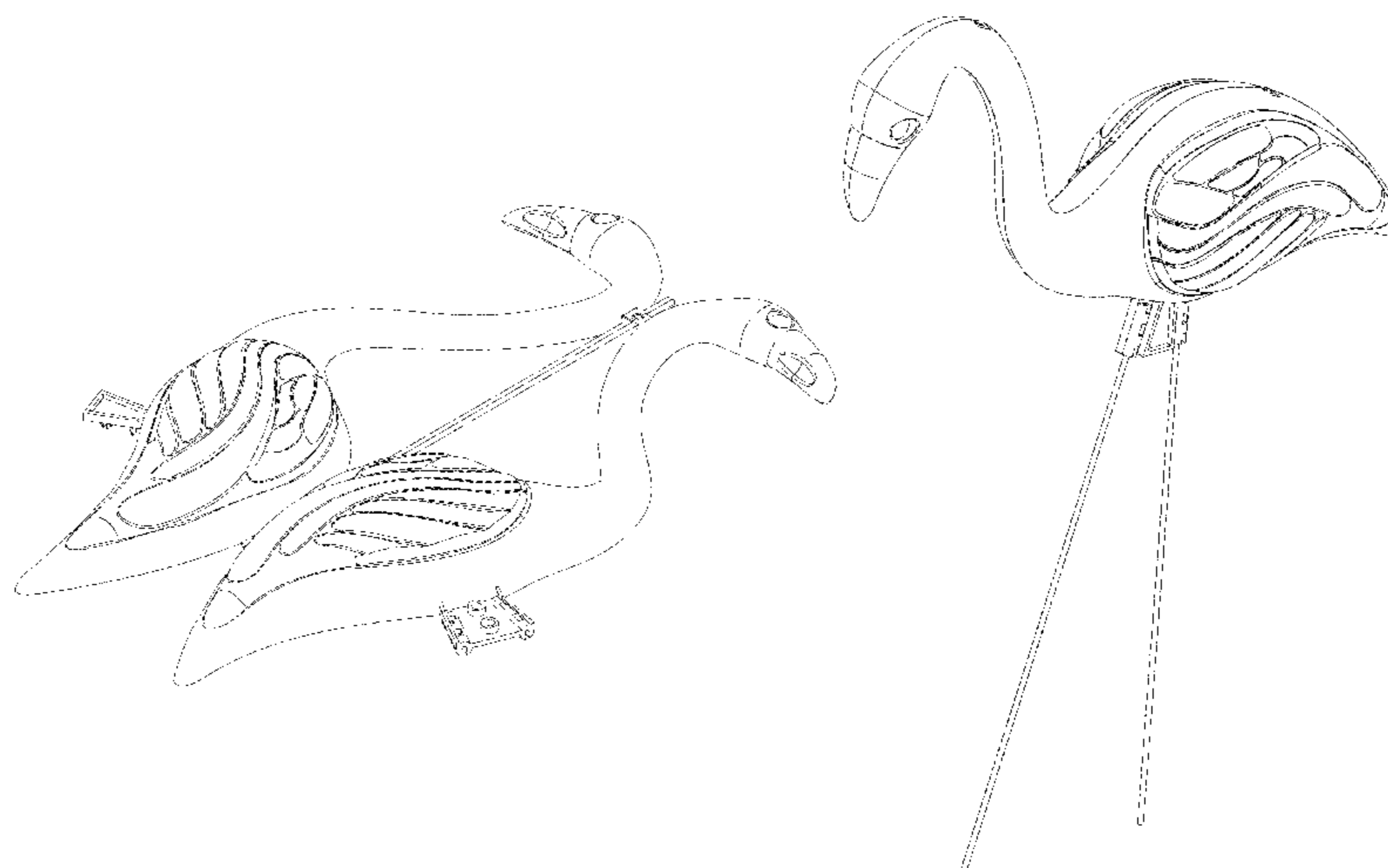

FIG. 21 is a rear side elevation view of the flamingo lawn ornament of FIG. 17;
FIG. 22 is a left side elevation view of the flamingo lawn ornament of FIG. 17;
FIG. 23 is a bottom view of the flamingo lawn ornament of FIG. 17;
FIG. 24 a rear perspective view of the flamingo lawn ornament of FIG. 17;
FIG. 25 is a front perspective view of the flamingo lawn ornament of FIG. 17, but shown with leg supports in a position of use;
FIG. 26 is a top plan view of the flamingo lawn ornament of FIG. 25;
FIG. 27 is a right side elevation view of the flamingo lawn ornament of FIG. 25;
FIG. 28 is a front side elevation view of the flamingo lawn ornament of FIG. 25;
FIG. 29 is a rear side elevation view of the flamingo lawn ornament of FIG. 25;
FIG. 30 is a left side elevation view of the flamingo lawn ornament of FIG. 25;
FIG. 31 is a bottom view of the flamingo lawn ornament of FIG. 25; and,

FIG. 32 a rear perspective view of the flamingo lawn ornament of FIG. 25.

1 Claim, 26 Drawing Sheets

(58) **Field of Classification Search**

USPC D21/441-446, 450, 453, 458, 465, 467,
D21/576, 585, 592, 606-609, 658, 578,
D21/584, 590, 650; D10/54, 59

See application file for complete search history.

(56) **References Cited**

U.S. PATENT DOCUMENTS

D436,329	S	*	1/2001	Sheridan	D11/162
D436,555	S	*	1/2001	Sheridan	D11/162
D455,674	S	*	4/2002	Ancona	D11/162
D463,511	S	*	9/2002	Weiser	D21/585
D474,421	S	*	5/2003	Weiser	D11/162
D487,714	S	*	3/2004	Weiser	D11/149
D496,410	S	*	9/2004	Weiser	D11/162
D569,305	S	*	5/2008	Chism	D11/158
D786,734	S	*	5/2017	Weiser	D11/162

* cited by examiner

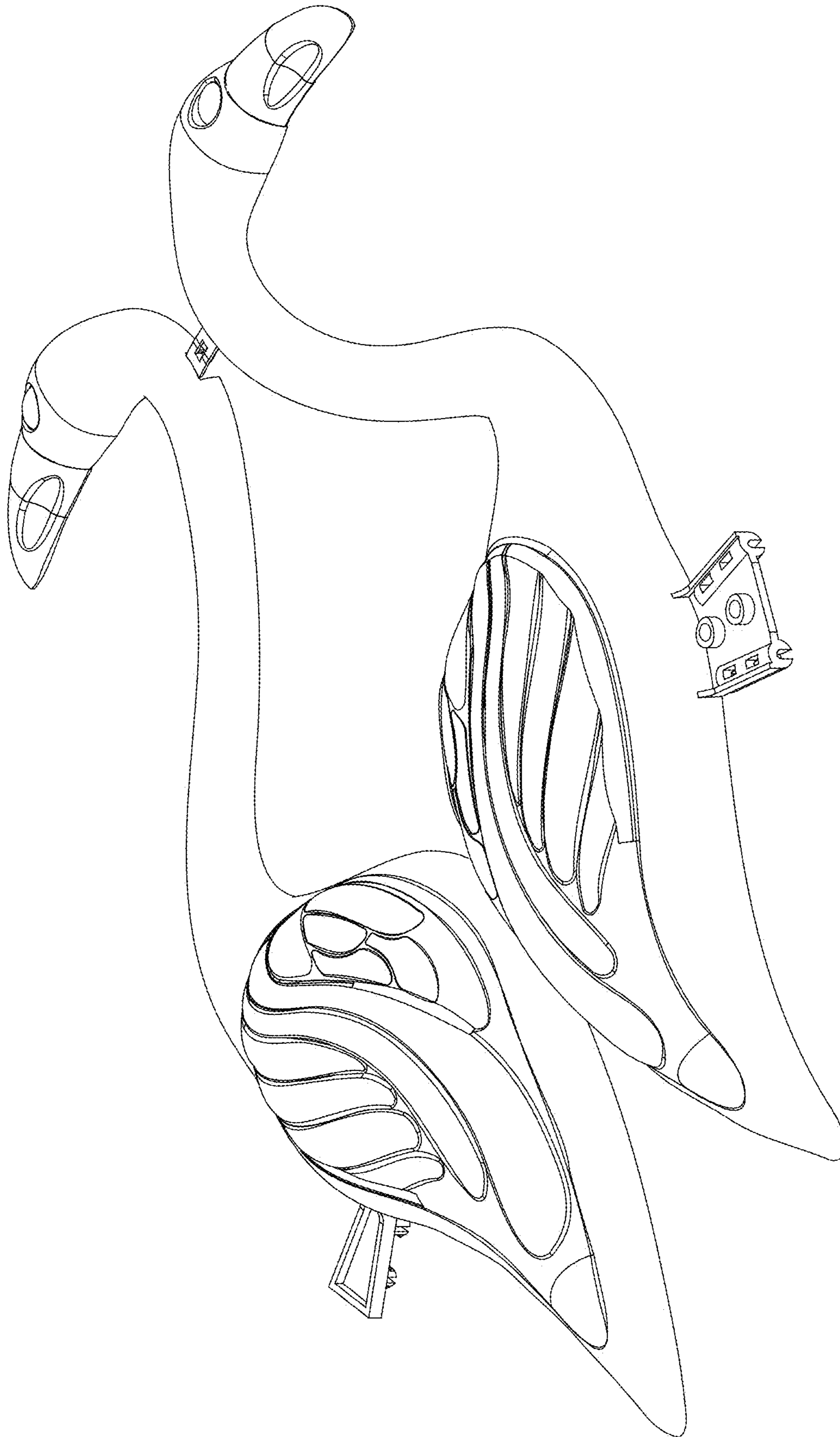

FIG. 1

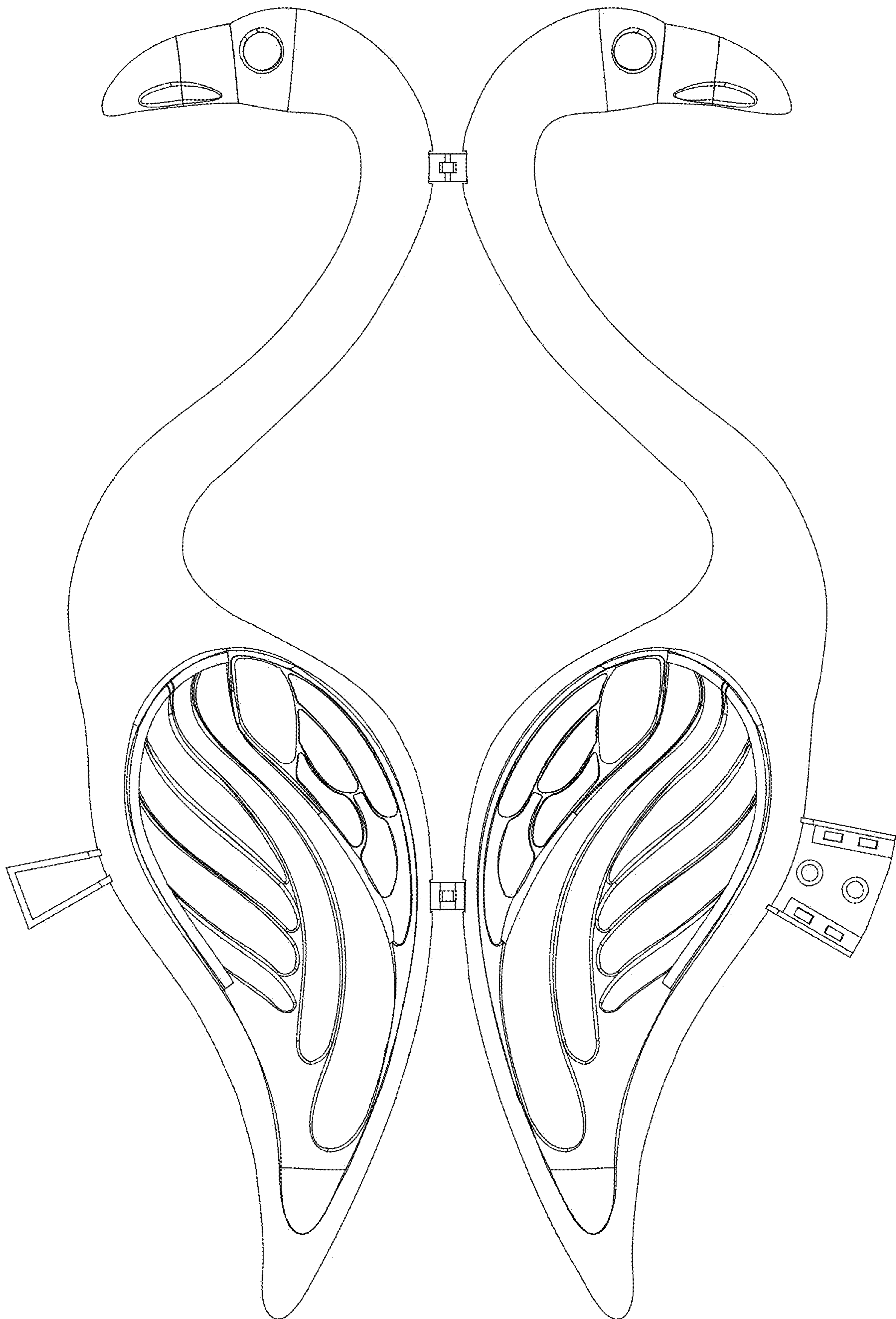

FIG. 2

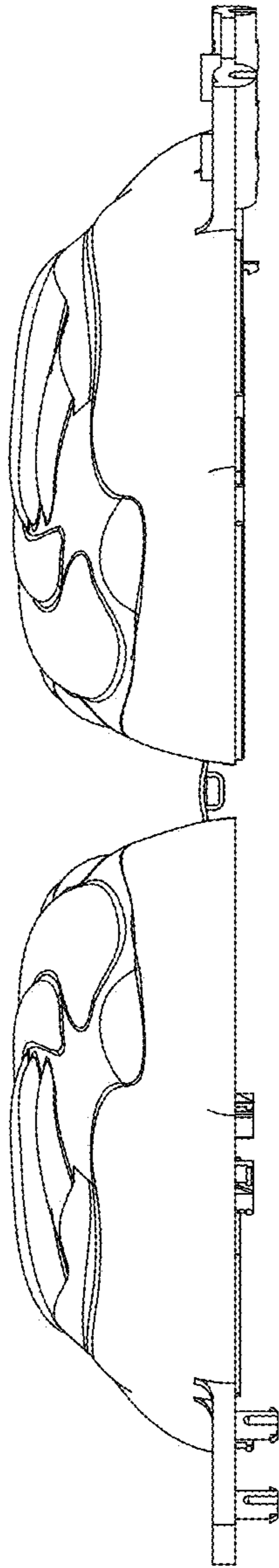

FIG. 3

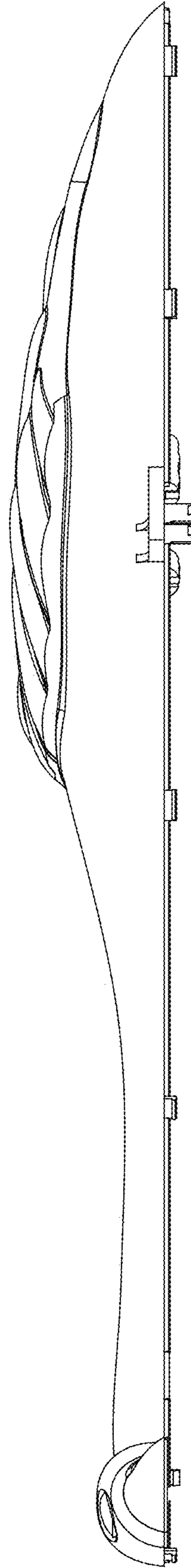

FIG. 4

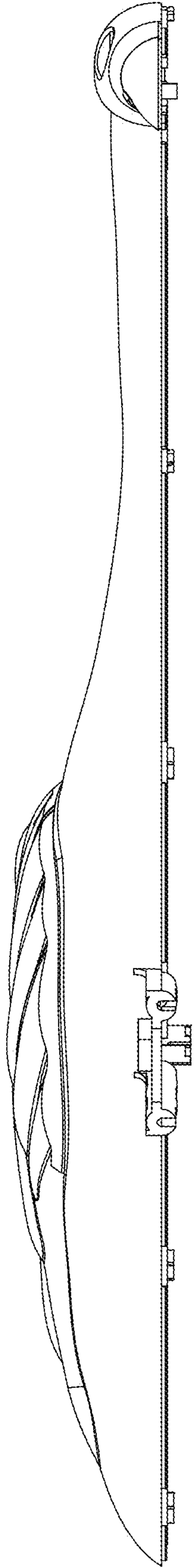

FIG. 5

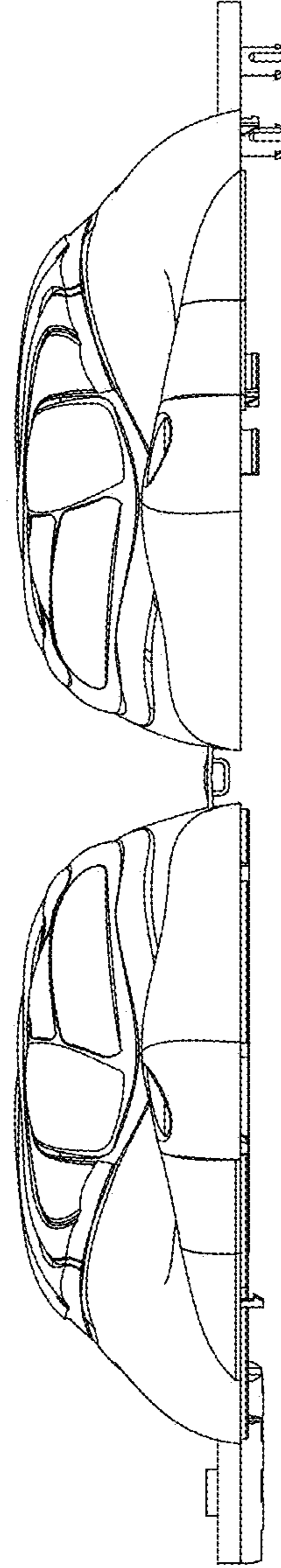

FIG. 6

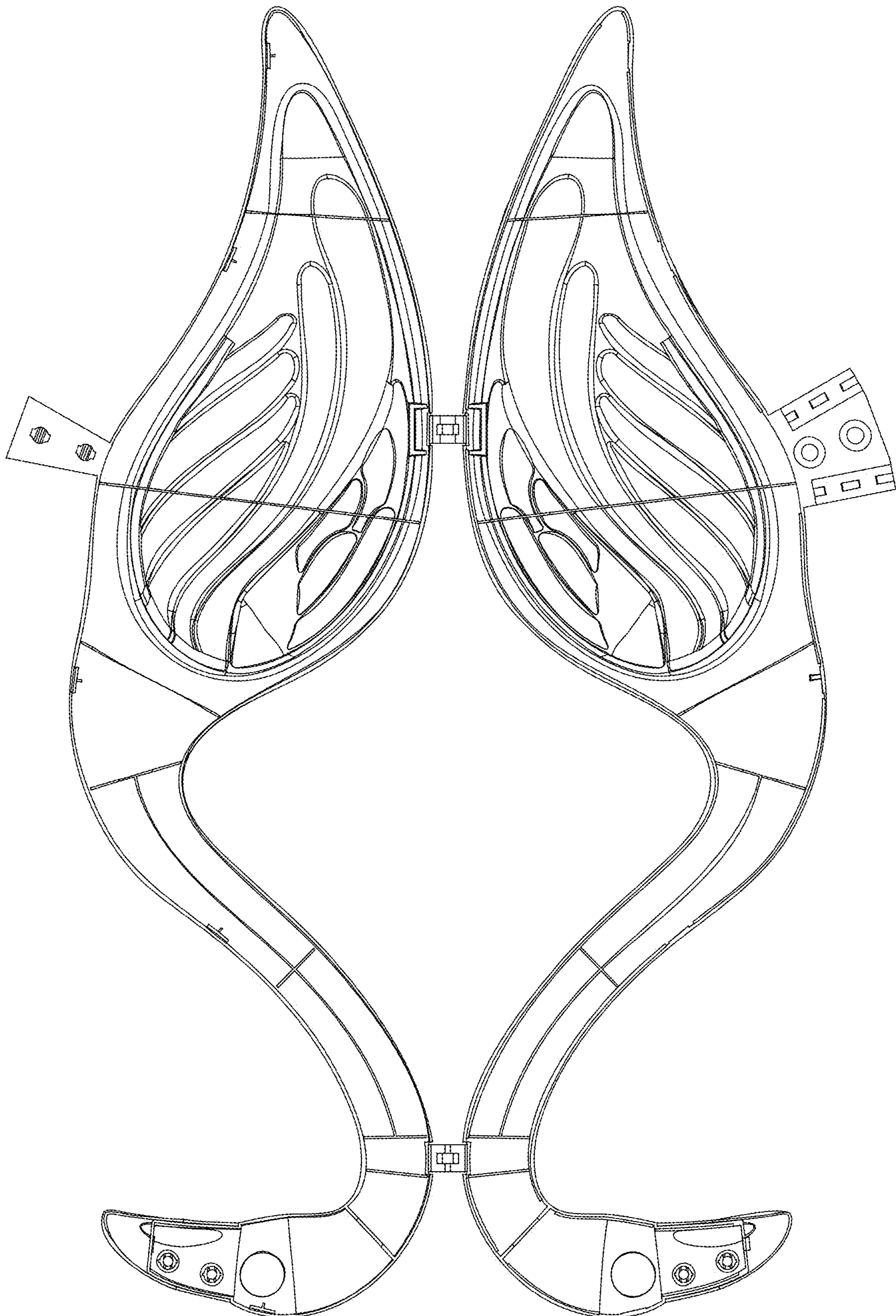

FIG. 7

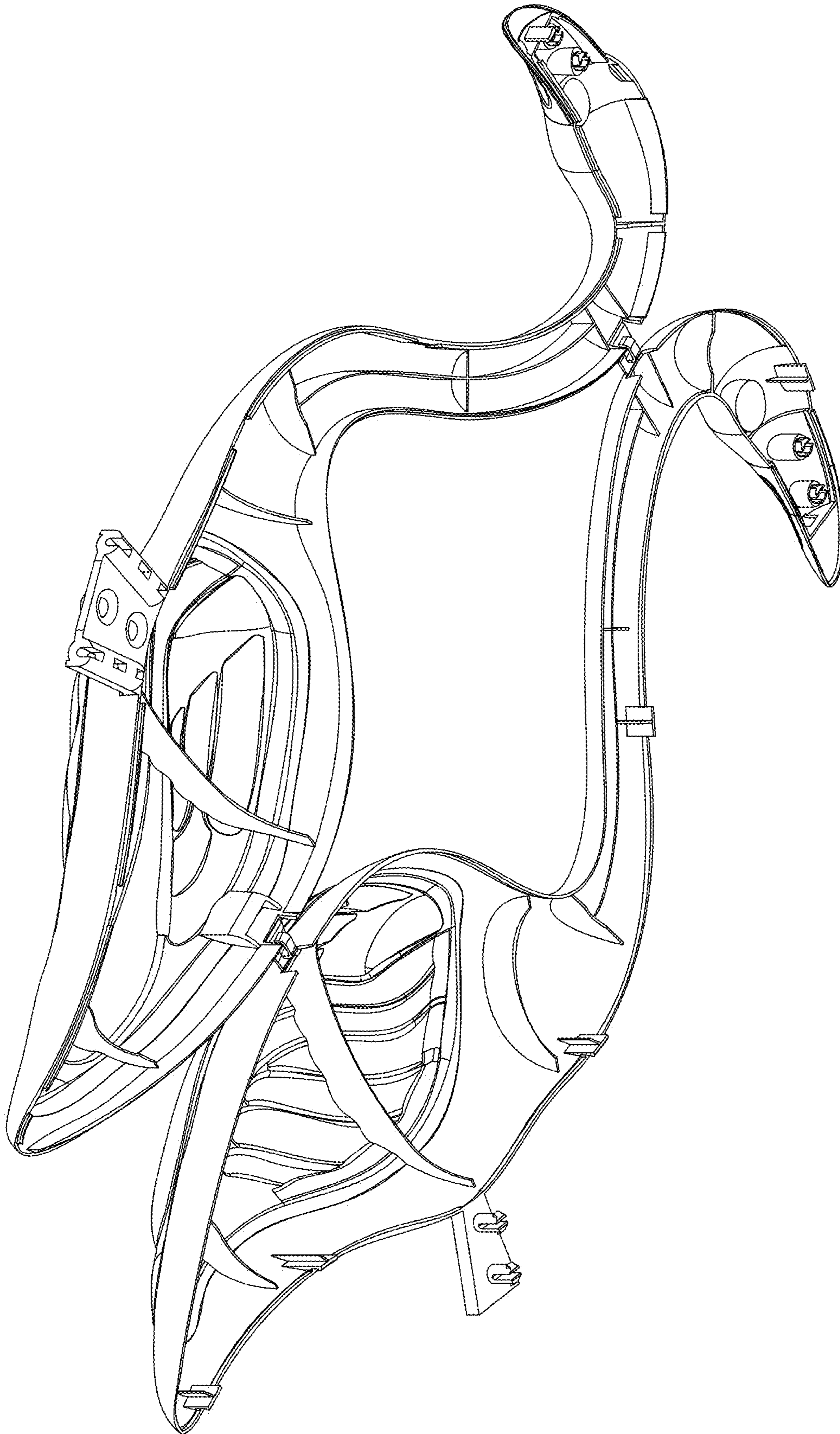

FIG. 8

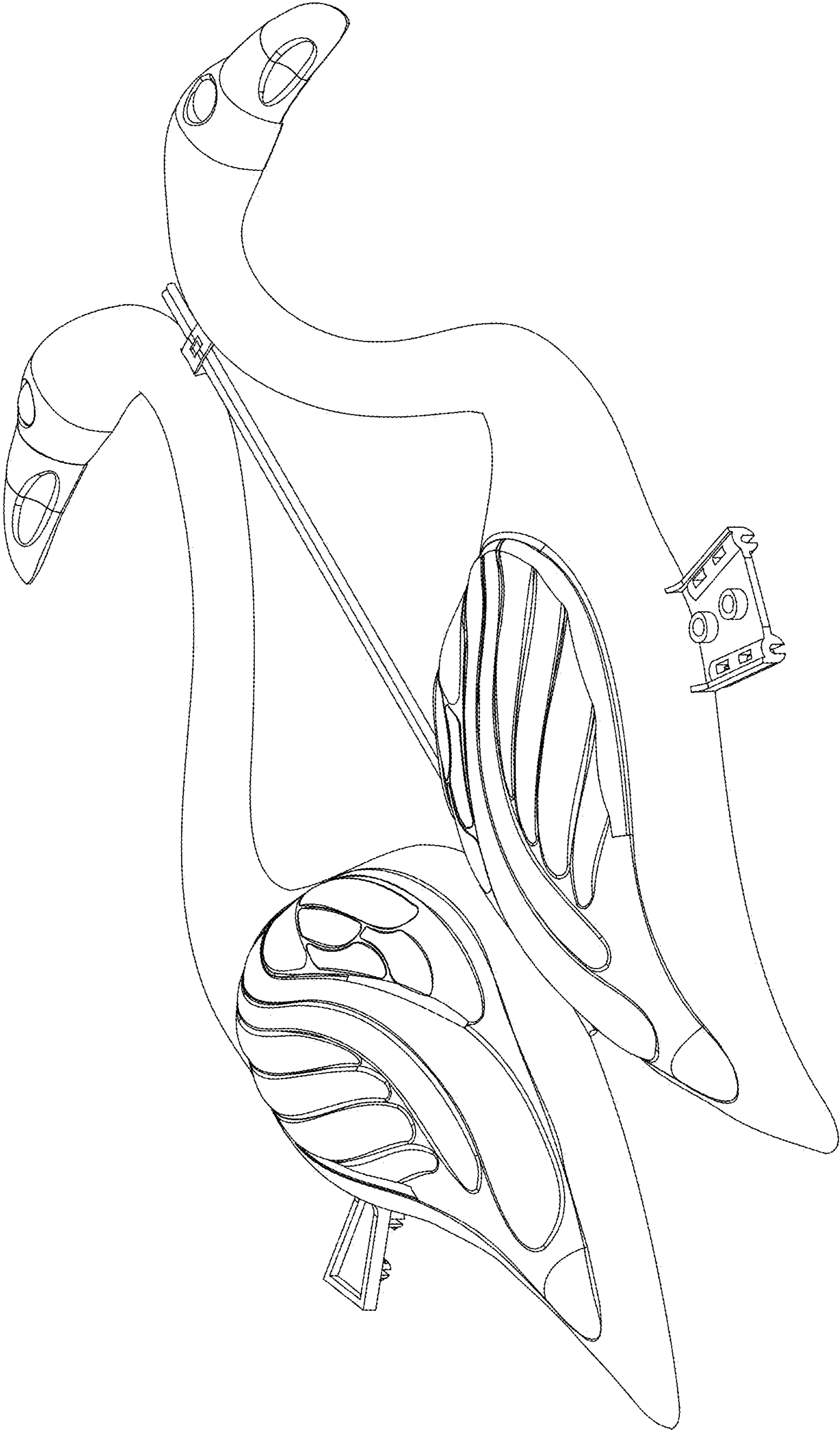

FIG. 9

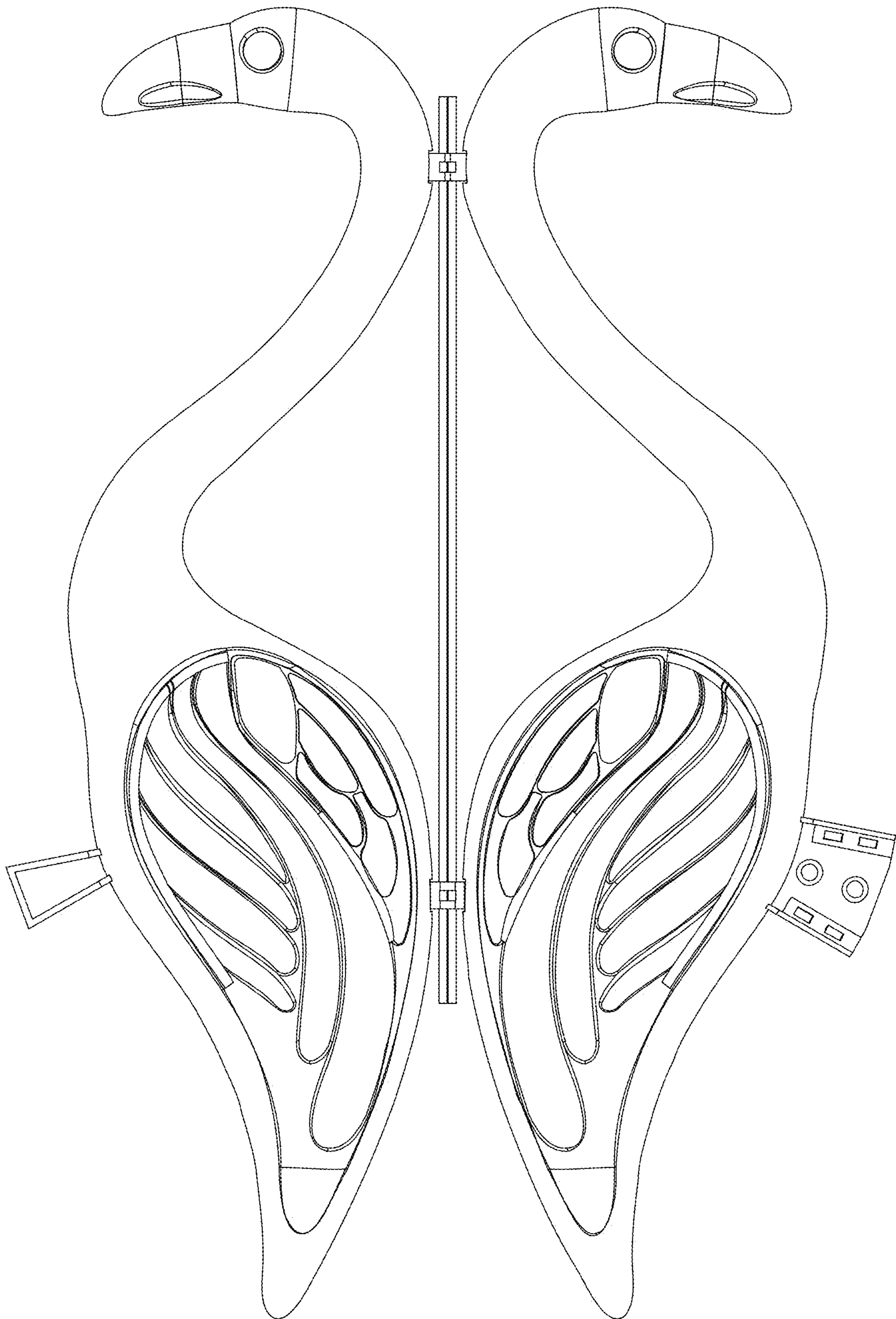

FIG. 10

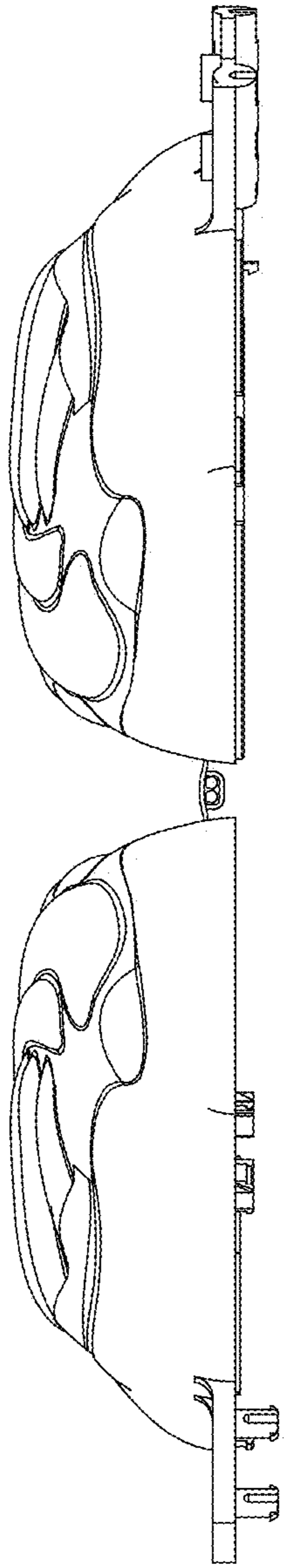

FIG. 11

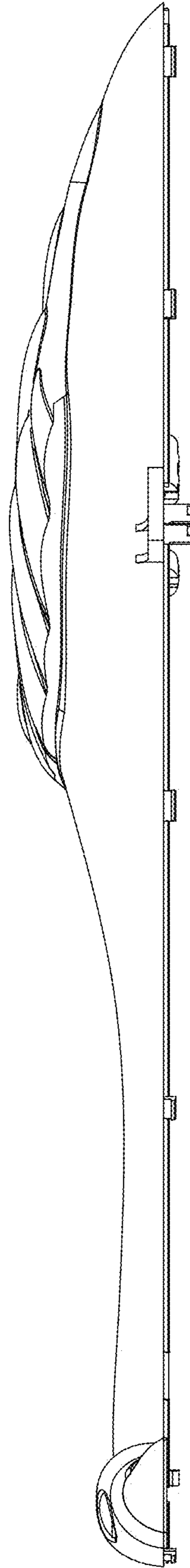

FIG. 12

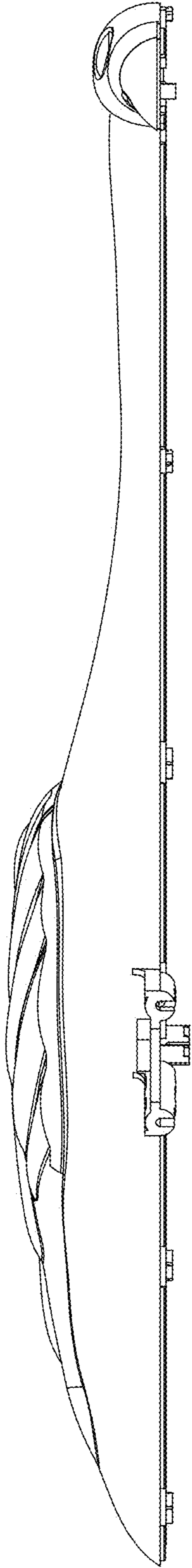

FIG. 13

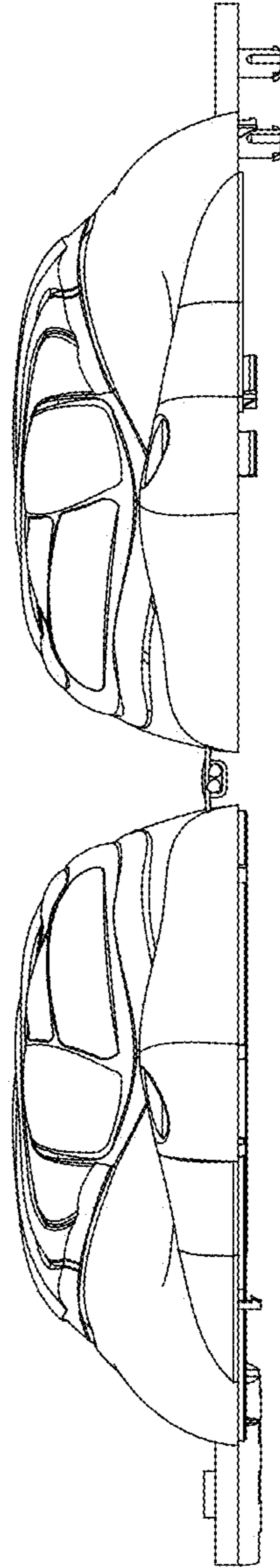

FIG. 14

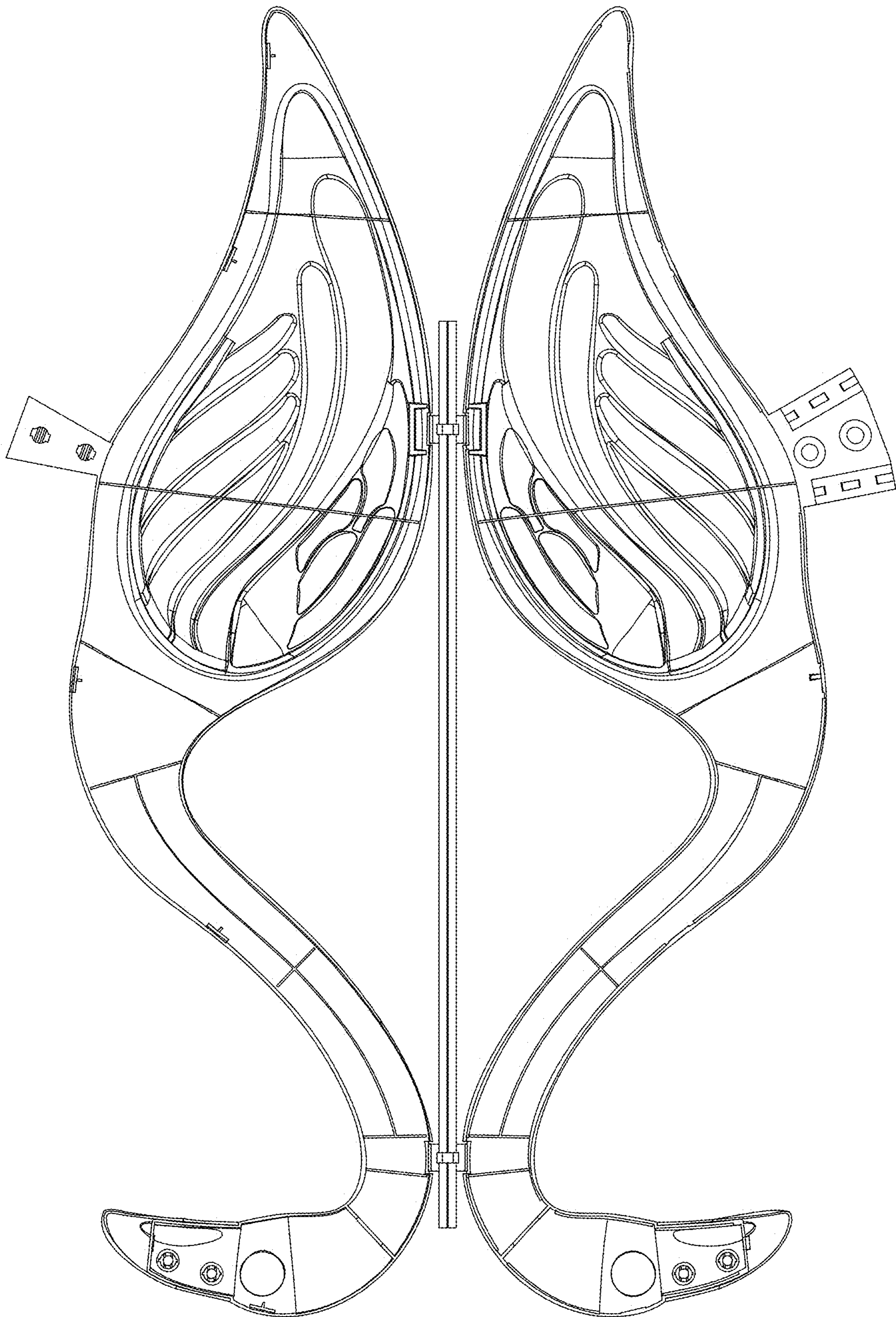

FIG. 15

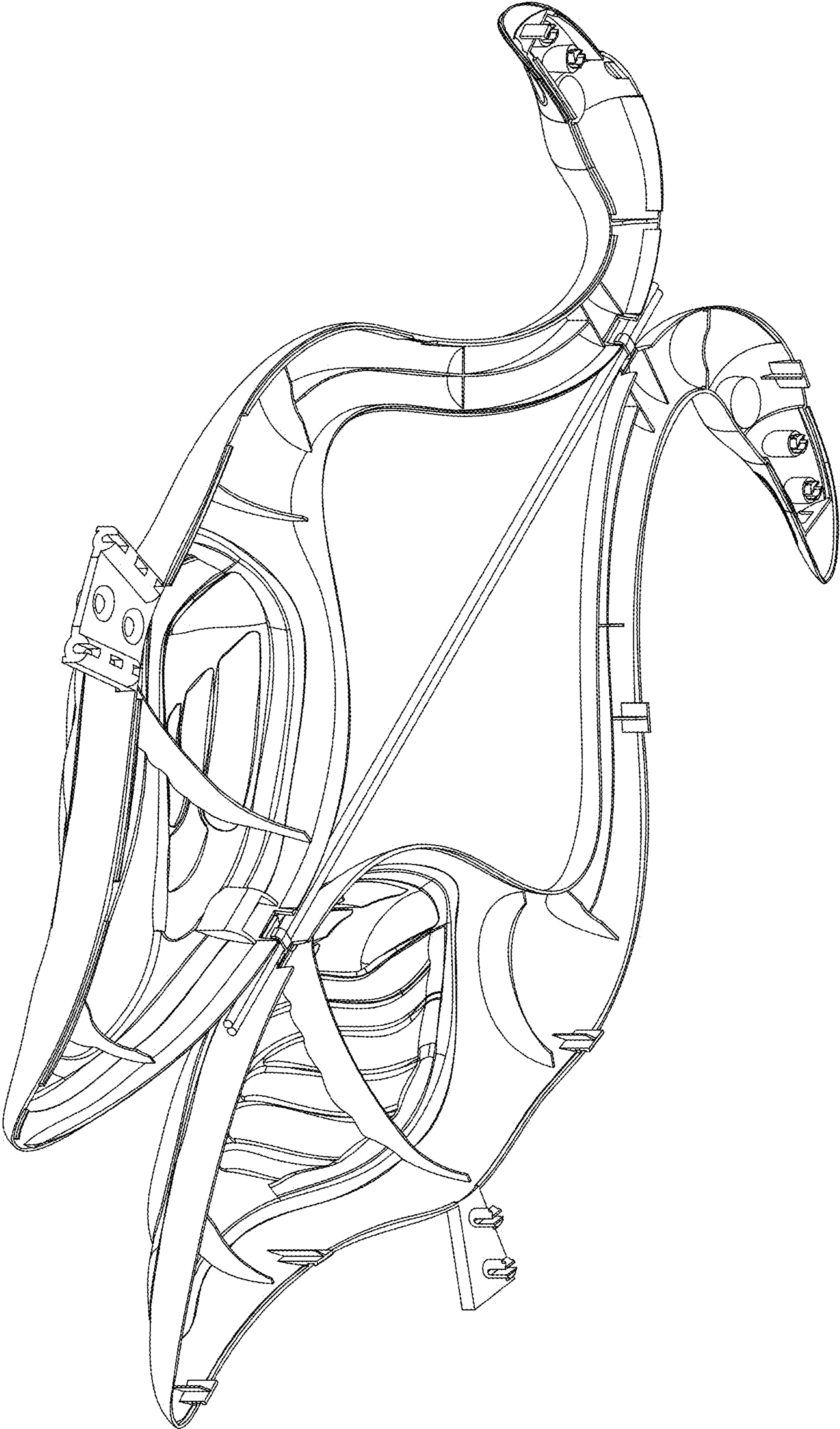

FIG. 16

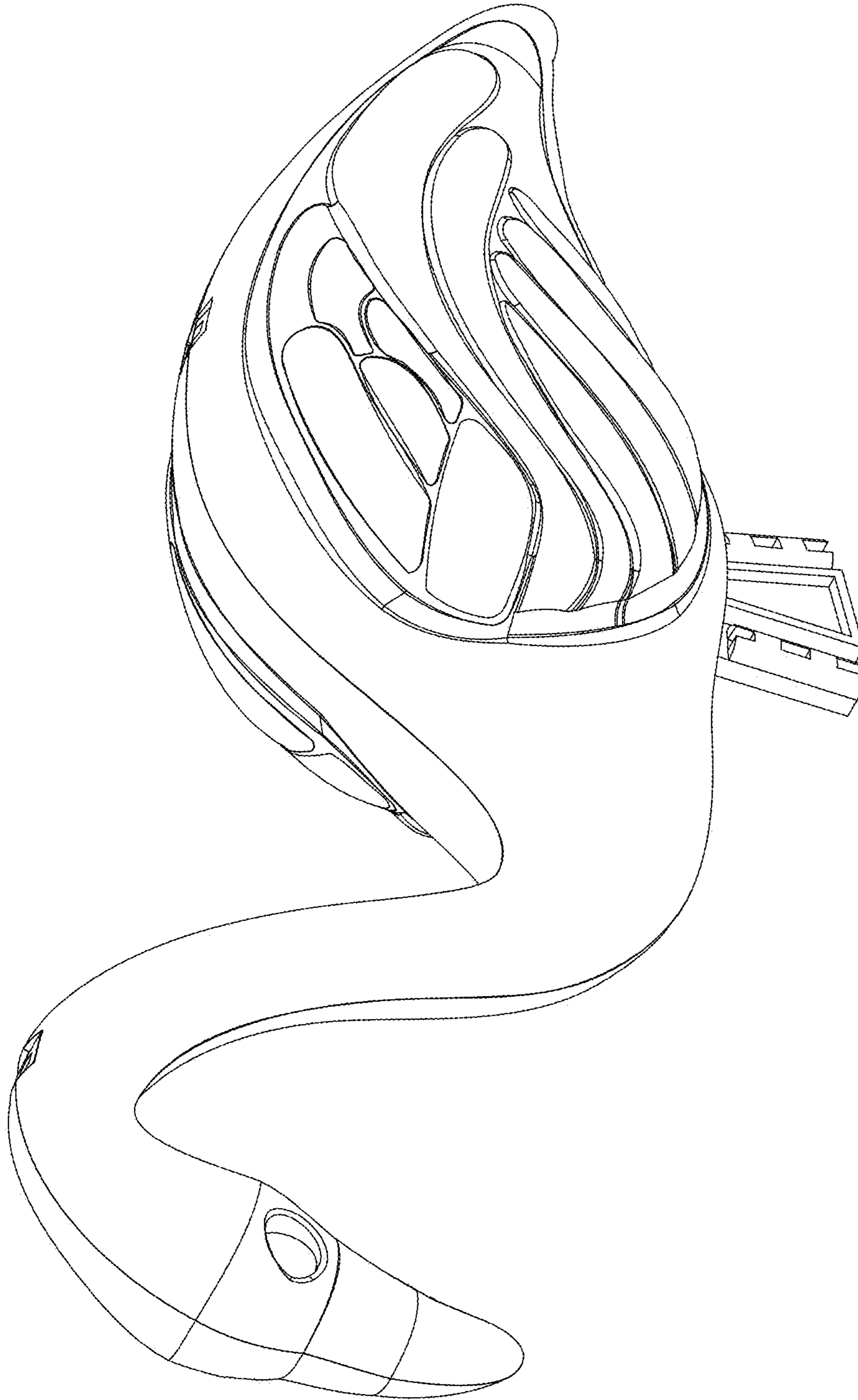

FIG. 17

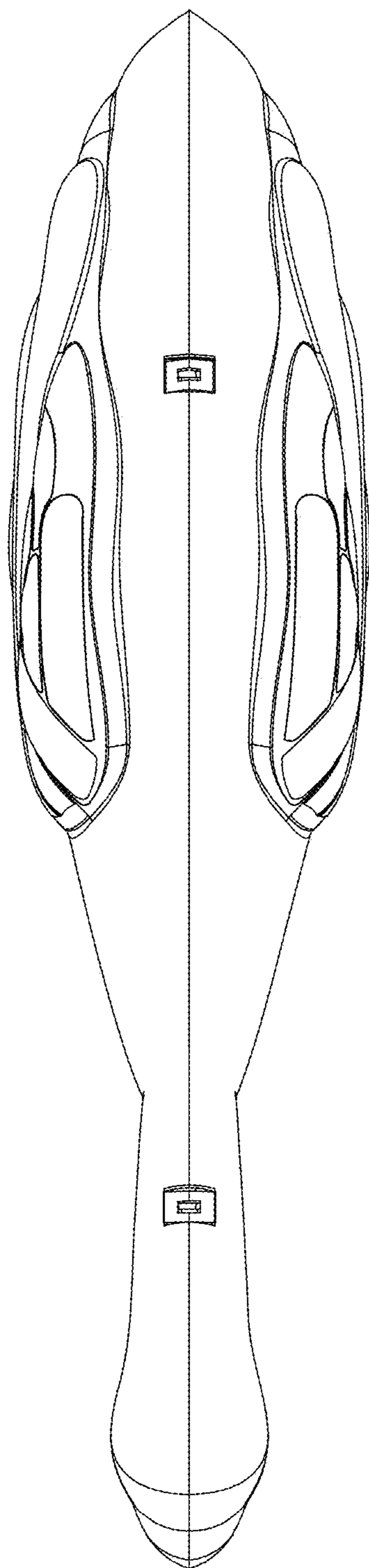

FIG. 18

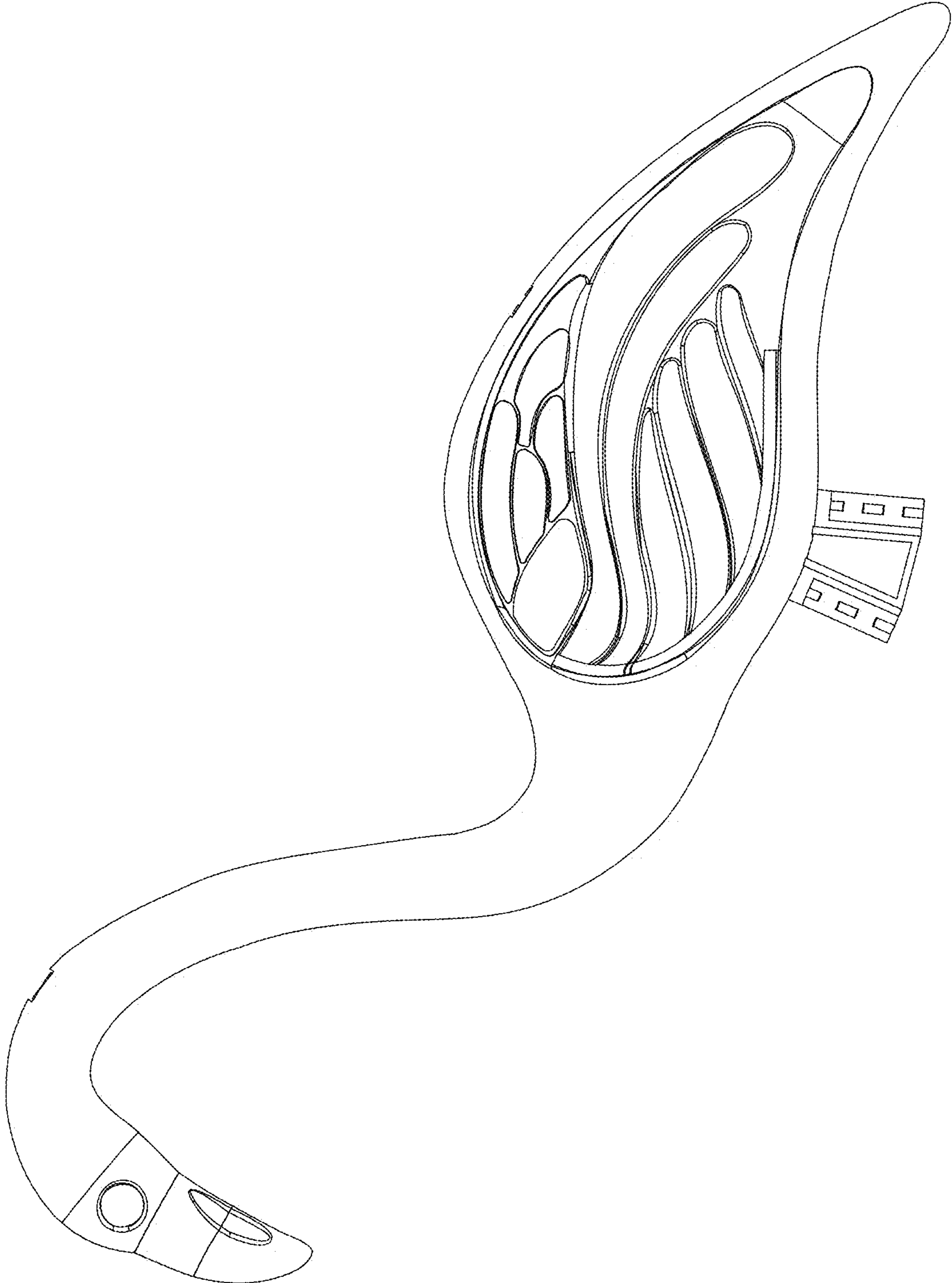

FIG. 19

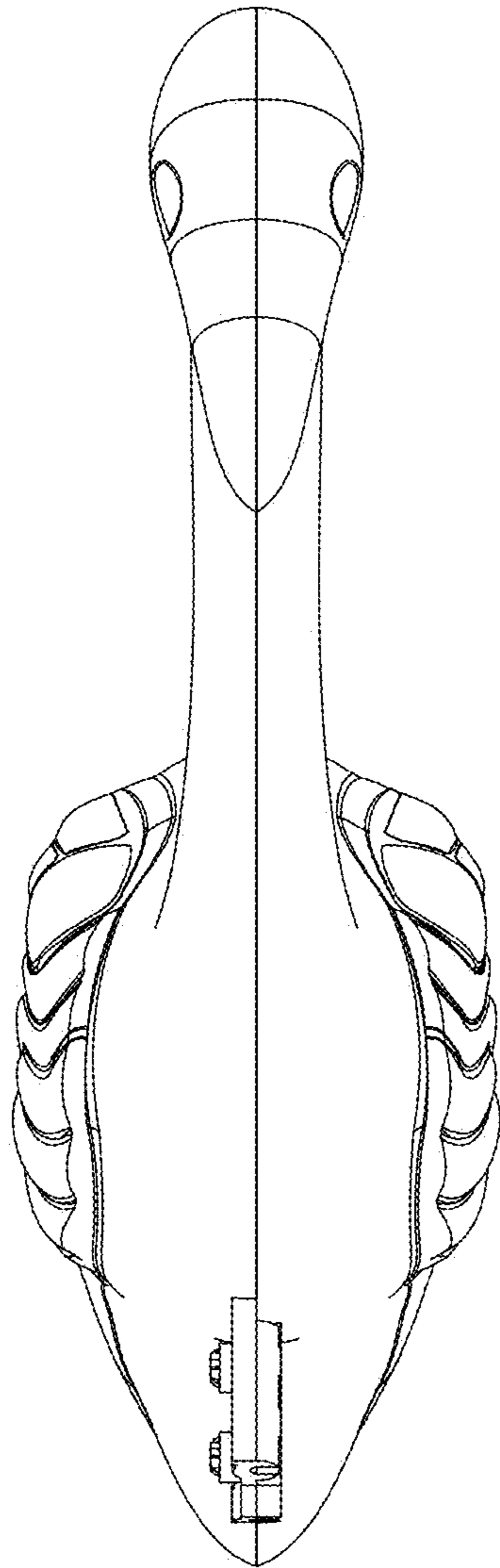

FIG. 20

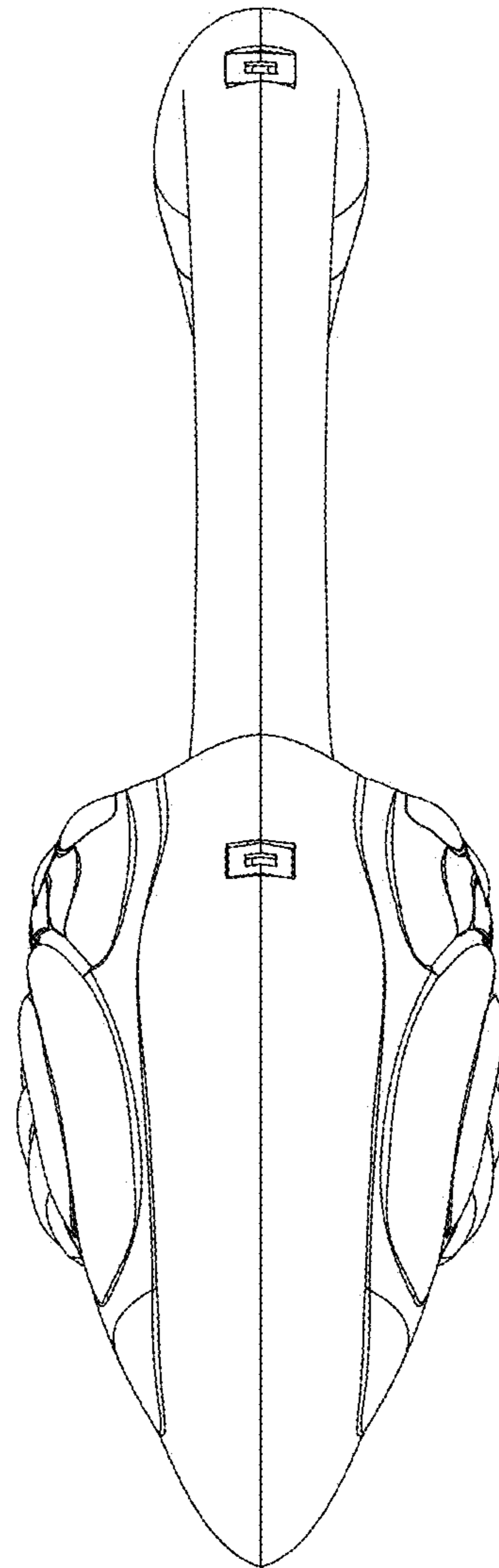

FIG. 21

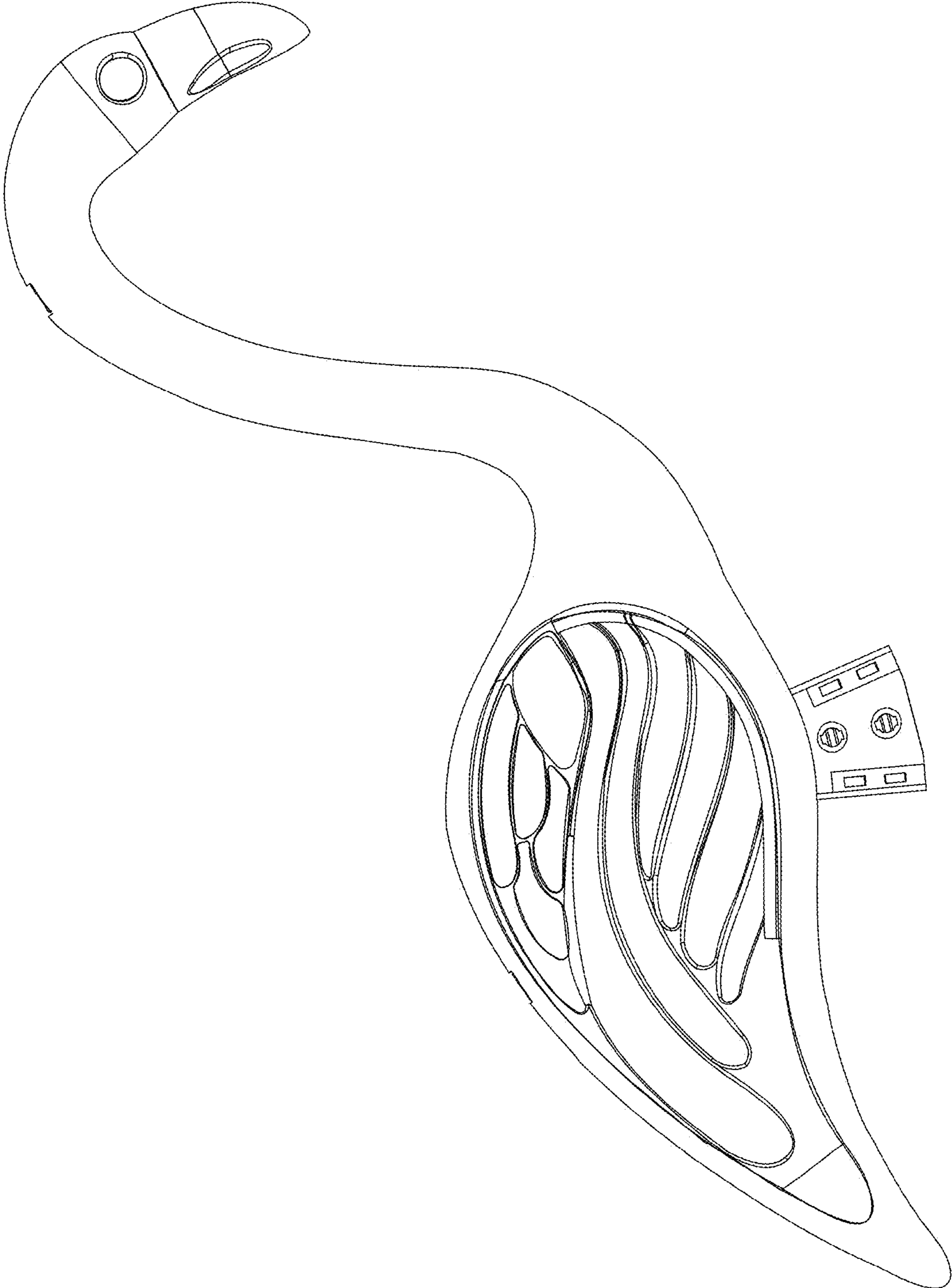

FIG. 22

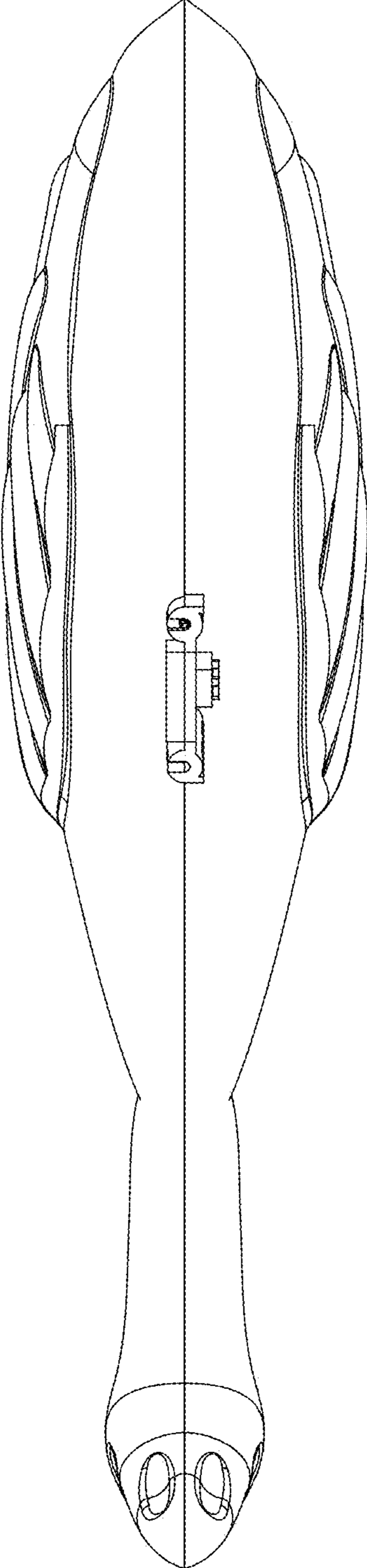

FIG. 23

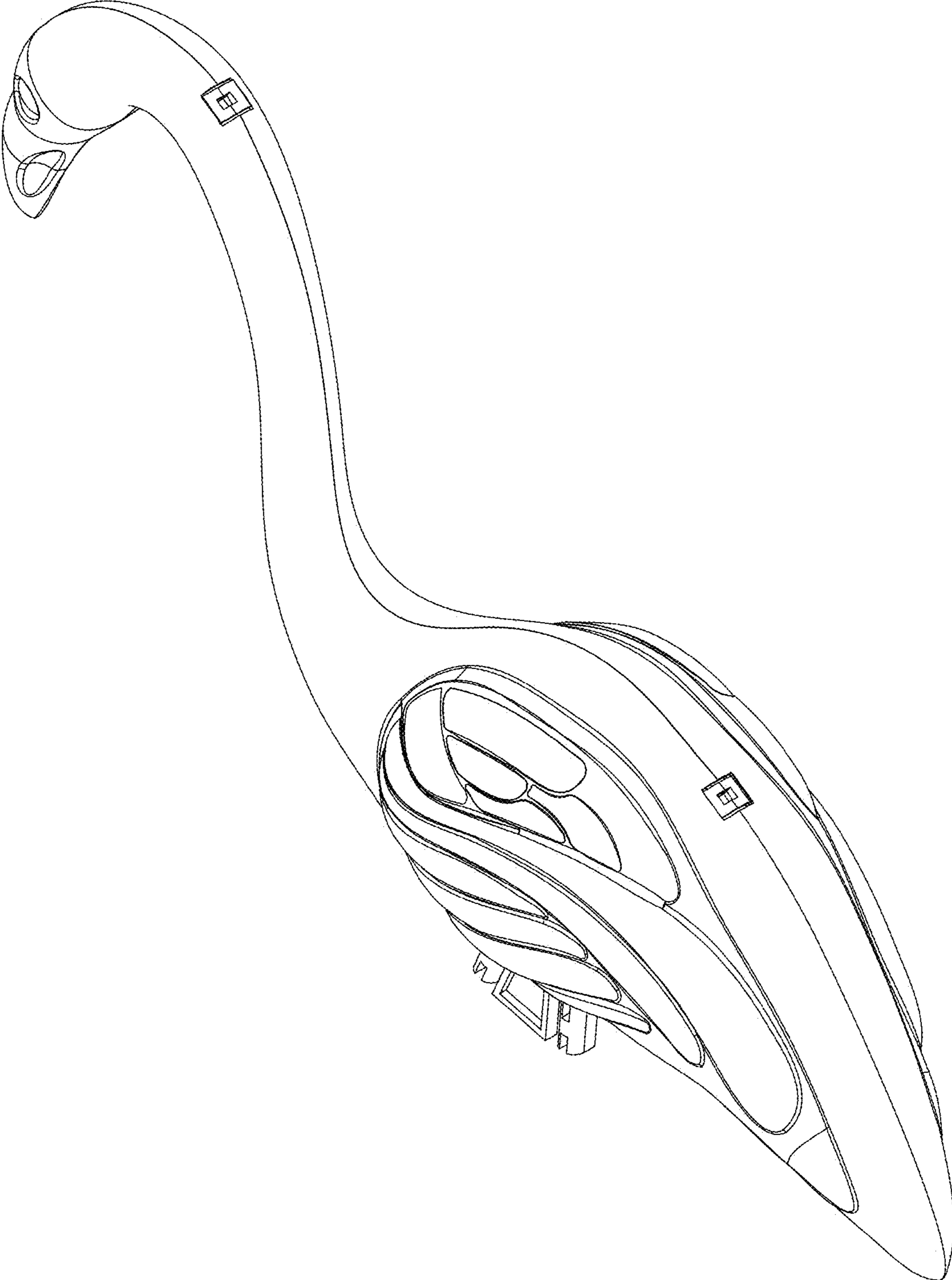

FIG. 24

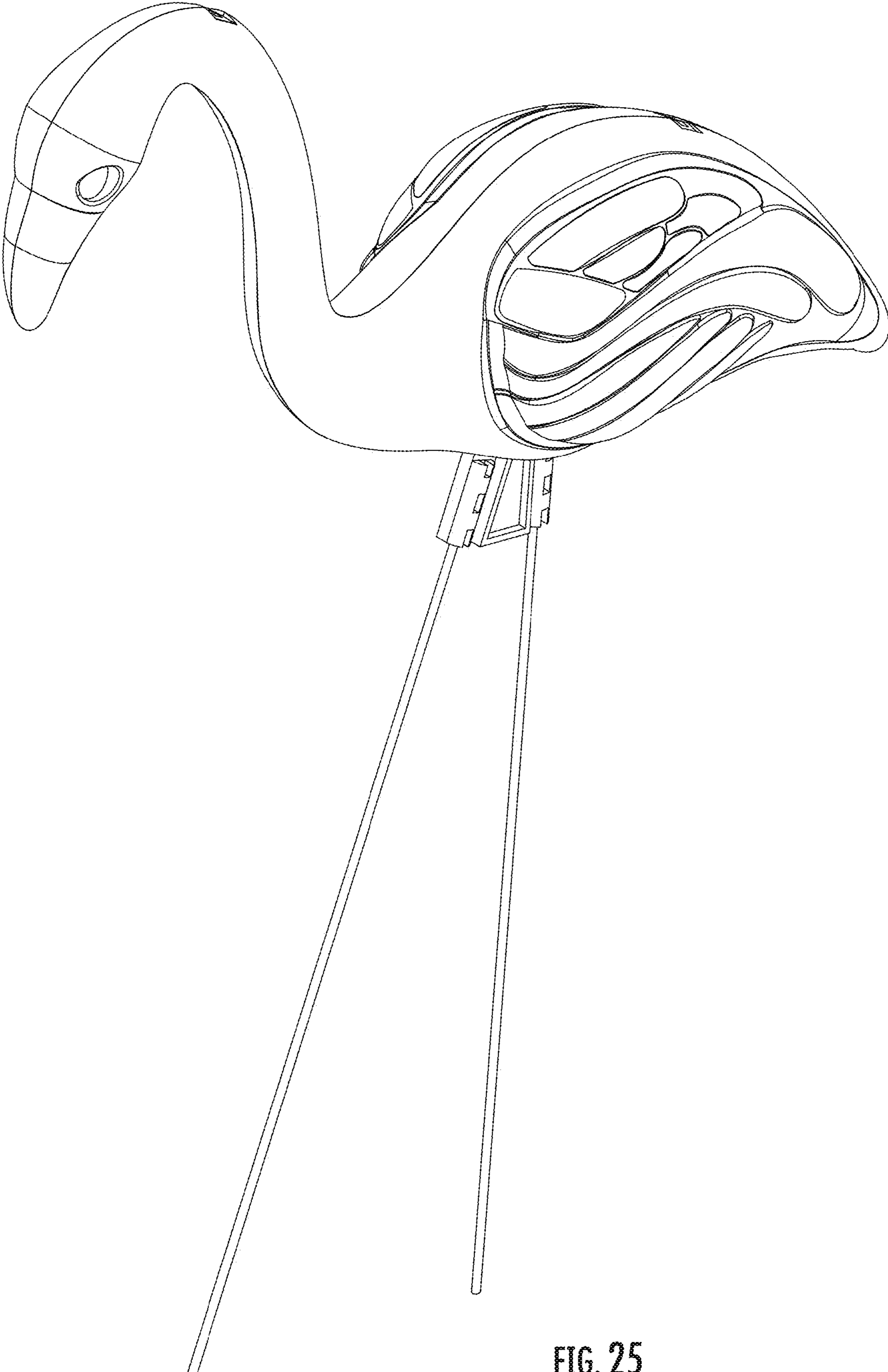

FIG. 25

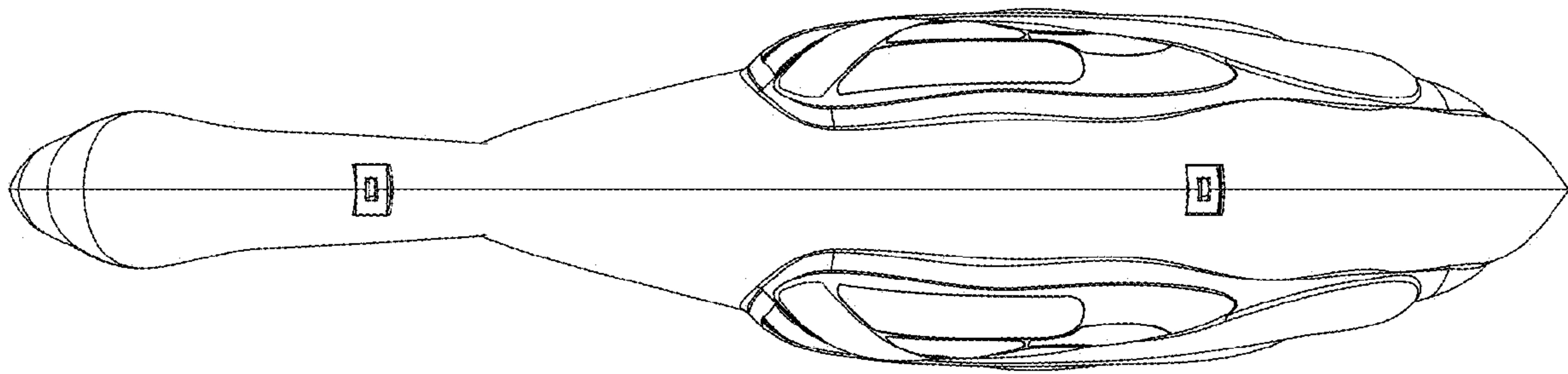

FIG. 26

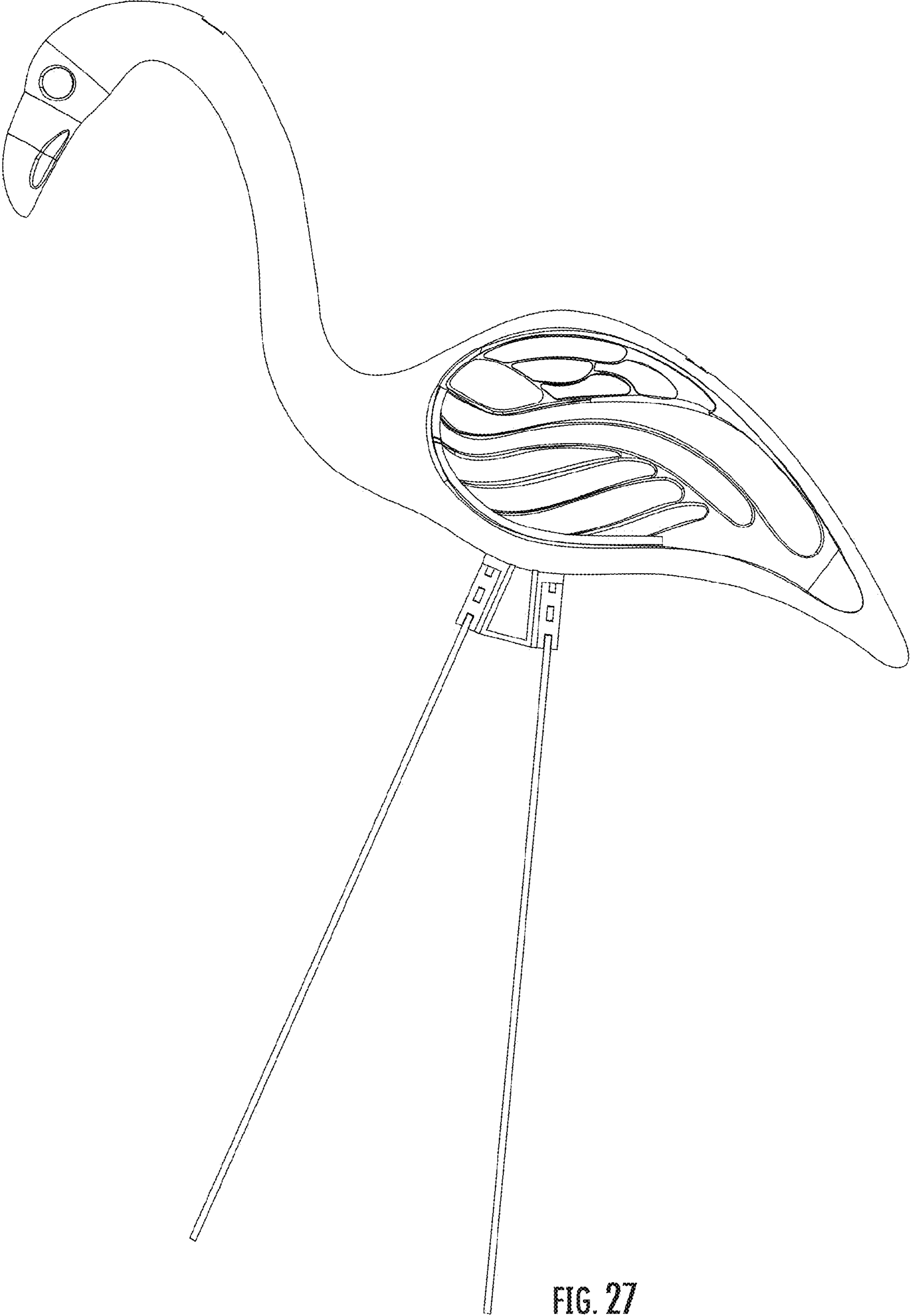

FIG. 27

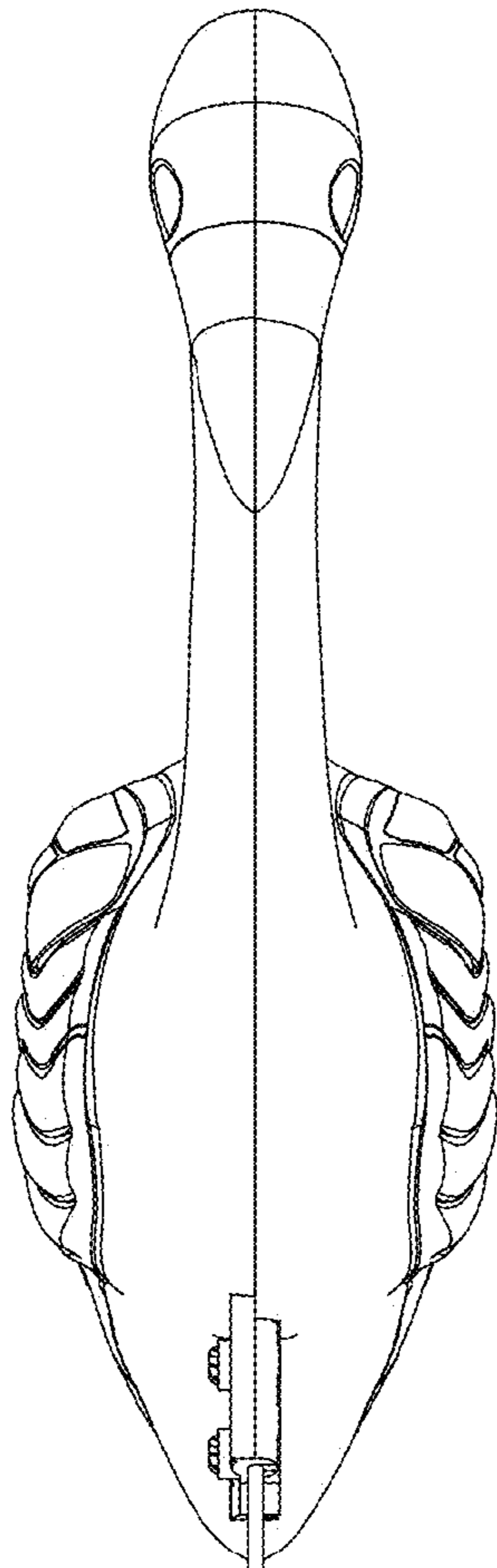

FIG. 28

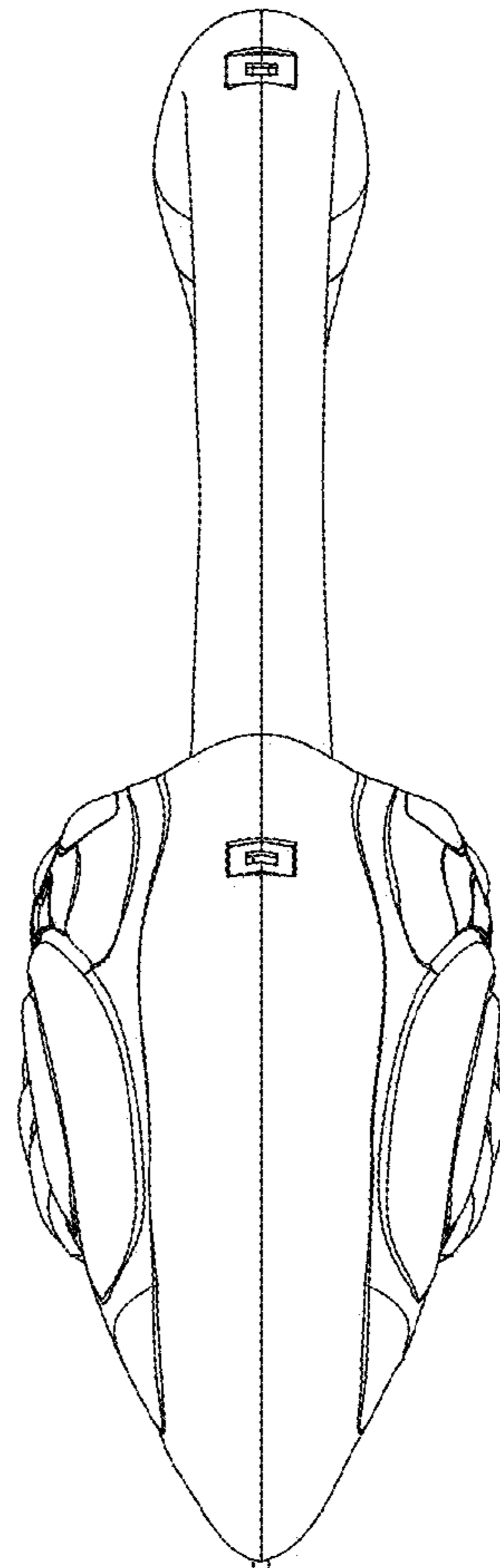

FIG. 29

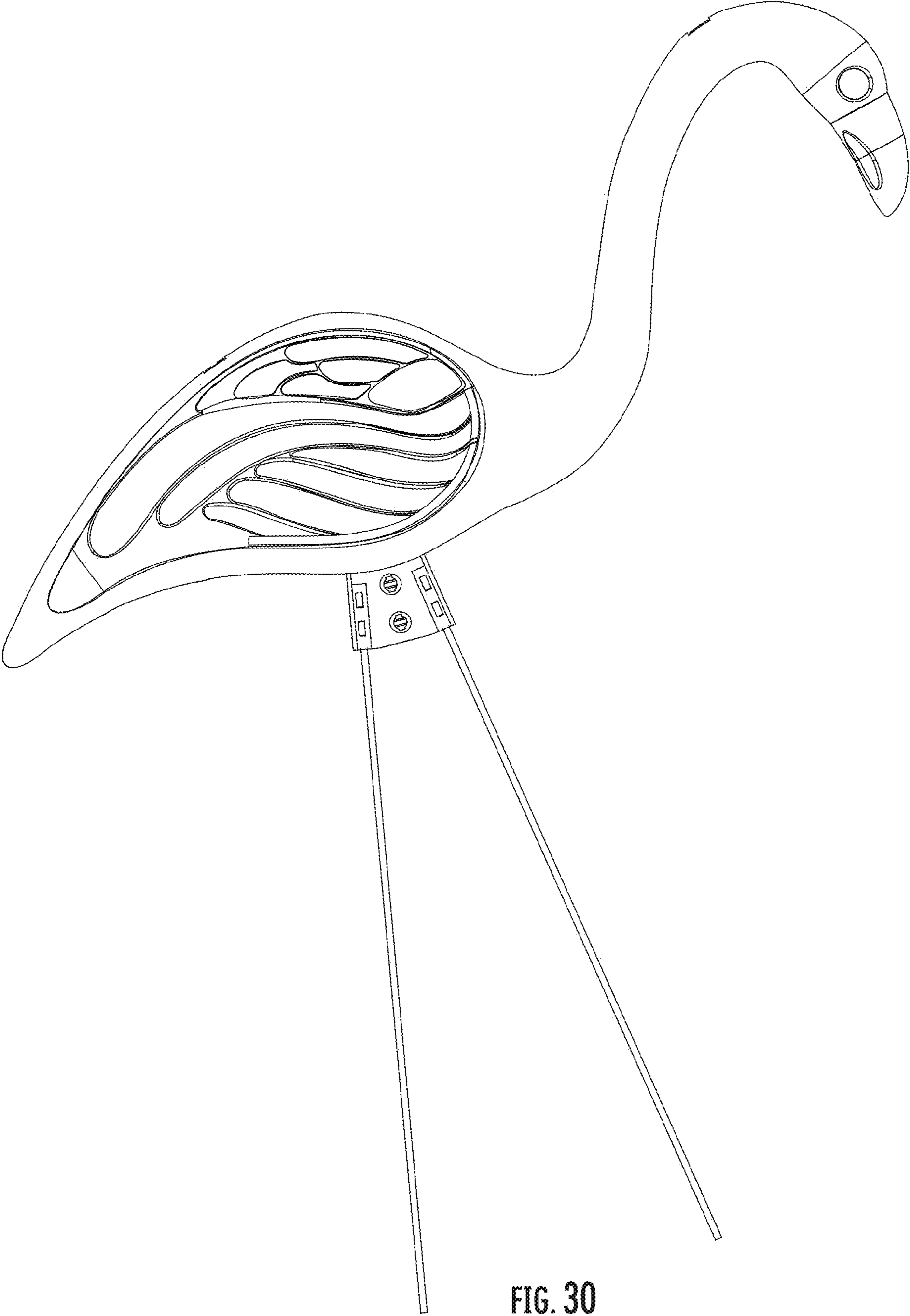

FIG. 30

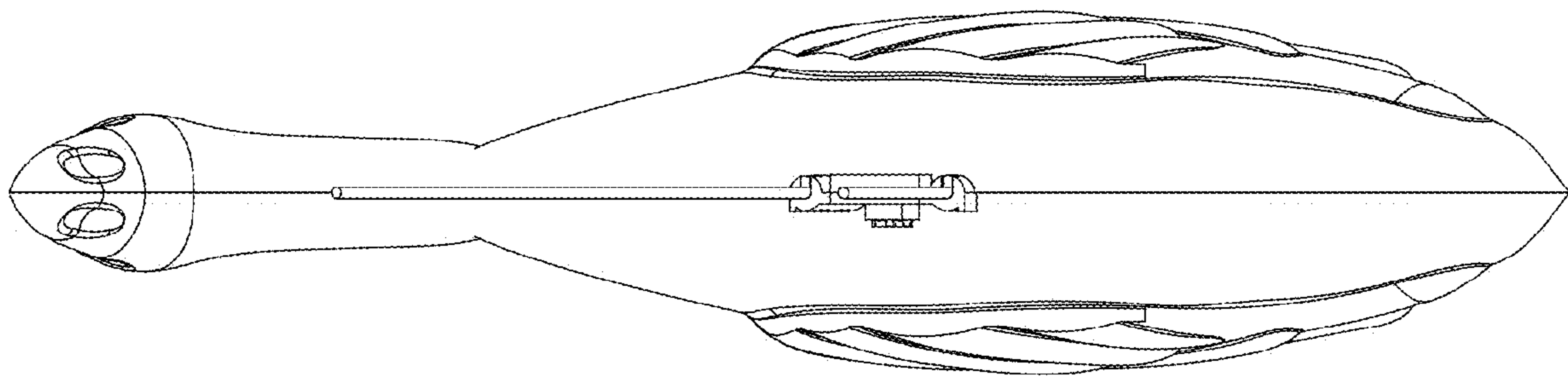

FIG. 31

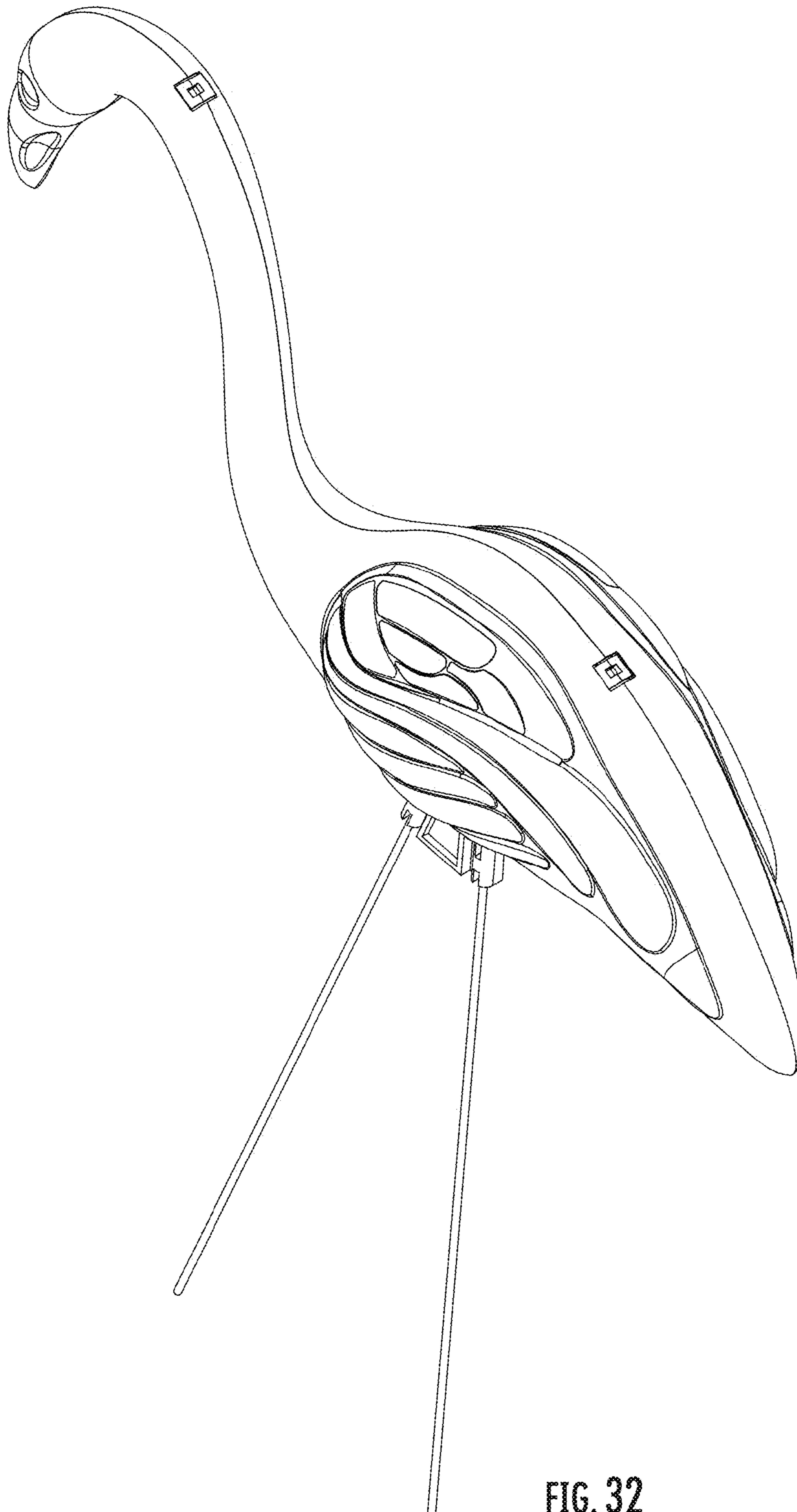

FIG. 32