



US00D962706S

(12) **United States Design Patent** (10) **Patent No.:** **US D962,706 S**
Smith et al. (45) **Date of Patent:** **** Sep. 6, 2022**

(54) **BEVERAGE CONTAINER**

(71) Applicant: **Pacific Market International, LLC**,
Seattle, WA (US)

(72) Inventors: **Ryan Michael Smith**, Seattle, WA
(US); **Matthew Kenneth Dolph**,
Seattle, WA (US)

(73) Assignee: **Pacific Market International, LLC**,
Seattle, WA (US)

(**) Term: **15 Years**

(21) Appl. No.: **29/751,155**

(22) Filed: **Sep. 18, 2020**

(51) **LOC (13) Cl.** **07-01**

(52) **U.S. Cl.**

USPC **D7/511; D7/523**

(58) **Field of Classification Search**

USPC D7/507, 509, 510, 511, 523, 533, 536,
D7/392.1, 396.1, 396.2, 608, 300.1, 598,
D7/600, 532, 900, 603, 316, 619.1;
D9/443, 446, 449, 561, 545; D3/202;
D29/125, 126; 220/713, 715

CPC B65D 1/40; B65D 21/086; B65D 21/02;
B65D 43/00; B65D 41/00; A47G 21/18;
A47G 19/22; A47G 19/2288; A47G
19/2205; A47G 23/16; A47G 19/2272;

(Continued)

(56) **References Cited**

U.S. PATENT DOCUMENTS

D57,567 S * 4/1921 Altenberg D7/608
1,575,870 A * 3/1926 Sehlbach A47G 19/2205
215/383

(Continued)

FOREIGN PATENT DOCUMENTS

CN 305748989 * 5/2020
CN 306643692 * 6/2021

(Continued)

OTHER PUBLICATIONS

Iceflow [online] URL: <https://www.stanley1913.com/products/the-iceflow-flip-straw-water-bottle-17-oz> (site visited: Jan. 25, 2022)
(Year: 2021).*

(Continued)

Primary Examiner — Jae Liang

Assistant Examiner — Tia Ruth-Renee Polidori

(74) *Attorney, Agent, or Firm* — George C. Rondeau, Jr.;
Davis Wright Tremaine LLP

(57) **CLAIM**

The ornamental design for a beverage container, as shown
and described.

DESCRIPTION

FIG. 1 is a top perspective view of a beverage container
showing our new design.

FIG. 2 is a bottom perspective view thereof.

FIG. 3 is a front elevational view thereof.

FIG. 4 is a left side elevational view thereof.

FIG. 5 is a right side elevational view thereof.

FIG. 6 is a rear elevational view thereof.

FIG. 7 is a top plan view thereof.

FIG. 8 is a bottom plan view thereof.

FIG. 9 is a top perspective view of a second embodiment
thereof.

FIG. 10 is a bottom perspective view thereof.

FIG. 11 is a front elevational view thereof.

FIG. 12 is a left side elevational view thereof.

FIG. 13 is a right side elevational view thereof.

FIG. 14 is a rear elevational view thereof.

FIG. 15 is a top plan view thereof; and,

FIG. 16 is a bottom plan view thereof.

The broken lines depict portions of the beverage container
that form no part of the claimed design.

1 Claim, 14 Drawing Sheets

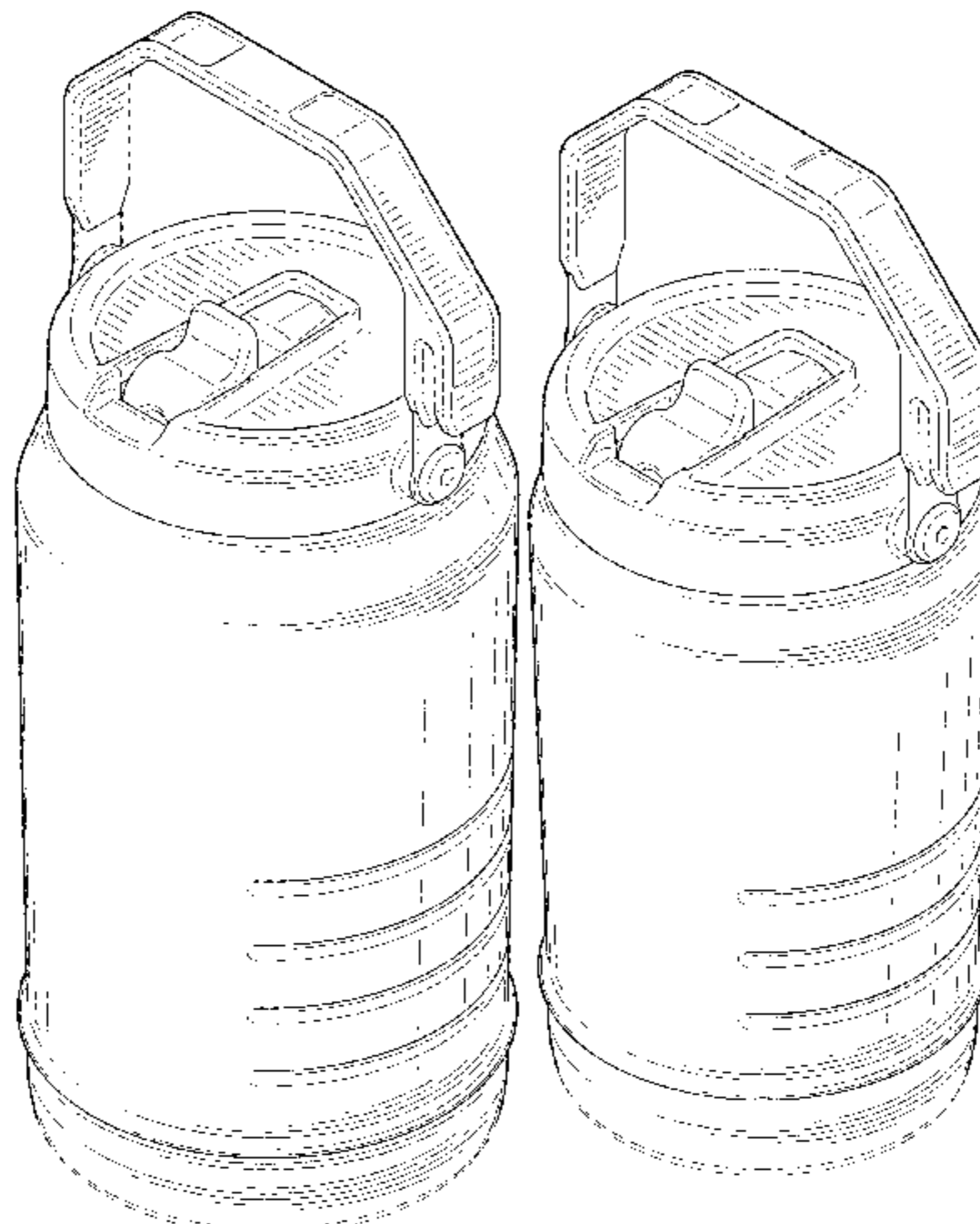

(58) **Field of Classification Search**

CPC A45F 2003/205; A47J 41/0055; A47J
41/0022; A47J 41/00; A47J 41/0077;
A47J 41/0088; A47J 41/02; Y10S
220/903

See application file for complete search history.

(56) **References Cited**

U.S. PATENT DOCUMENTS

D107,988 S * 1/1938 Hansen D7/523
D107,990 S * 1/1938 Hansen D7/532
D107,994 S * 1/1938 Hansen D7/532
D108,421 S * 2/1938 Brill D7/532
D120,134 S * 4/1940 Morrison D7/532
D244,502 S * 5/1977 Harbaugh D7/532
D404,306 S * 1/1999 Steinke D9/557
D410,821 S * 6/1999 Huang D7/608
D411,716 S * 6/1999 Besser D7/608
6,065,624 A * 5/2000 Steinke B65D 1/0276
220/675
D451,807 S * 12/2001 Goettner D9/502
D453,003 S * 1/2002 Rashid D9/557
D457,435 S * 5/2002 Rashid D9/502
6,510,967 B1 * 1/2003 DeSimone B65D 83/206
222/402.1
D479,669 S * 9/2003 Norris D7/532
D480,916 S * 10/2003 Norris D7/532
D481,317 S * 10/2003 Corker D9/557
D518,335 S * 4/2006 Naft A47G 19/2266
D7/320
D526,827 S * 8/2006 Allen D7/320
D653,082 S * 1/2012 George D7/510
D659,474 S * 5/2012 Wahl D7/510
D660,082 S * 5/2012 Wahl D7/510
D669,737 S * 10/2012 Nemeth D7/532
D707,492 S * 6/2014 George D7/510
D718,980 S * 12/2014 Lapsker D7/532
D734,096 S * 7/2015 George D7/523
D808,722 S * 1/2018 Hill D7/510
D809,344 S * 2/2018 Guthrie D7/511
D809,347 S * 2/2018 Silsby D7/608
D817,093 S * 5/2018 Silsby D7/510
D817,094 S * 5/2018 Silsby D7/510
D821,135 S * 6/2018 Rane D7/391
D821,151 S * 6/2018 Lapsker D7/511
D828,097 S * 9/2018 Silsby D7/523
D857,462 S * 8/2019 Silsby D7/608
D862,985 S * 10/2019 Backs D7/511
D880,941 S * 4/2020 Silsby D7/510
D895,367 S * 9/2020 Hamilton D7/523
D895,370 S * 9/2020 Hamilton D7/536
D896,574 S * 9/2020 Wang D7/392.1
D897,760 S * 10/2020 Feng D7/392.1
D903,403 S * 12/2020 Ames D7/392
D903,421 S * 12/2020 Wahl D7/532
D904,109 S * 12/2020 Yao D7/392.1
D912,466 S * 3/2021 Silsby D7/510
D914,454 S * 3/2021 Silsby D7/510
D915,821 S * 4/2021 Ludolph D7/396.2
D917,968 S * 5/2021 Silsby D7/510
D923,410 S * 6/2021 Hamilton D7/523
D924,626 S * 7/2021 Wang D7/392.1
D929,183 S * 8/2021 Wahl D7/511

D929,184 S * 8/2021 Wahl D7/511
D930,427 S * 9/2021 Ayres D7/392.1
D935,265 S * 11/2021 Chen D7/392.1
D935,836 S * 11/2021 Wang D7/392.1
D935,837 S * 11/2021 Wang D7/392.1
D938,778 S * 12/2021 Ge D9/450
D938,784 S * 12/2021 Silsby D7/608
D939,280 S * 12/2021 Vierck D7/510
D939,887 S * 1/2022 Hao D7/392.1
D939,888 S * 1/2022 Wang D7/392.1
D940,501 S * 1/2022 Burga D7/392.1
D941,091 S * 1/2022 Delgado Carmona D7/510
D946,977 S * 3/2022 Wahl D7/624.2
D946,978 S * 3/2022 Wahl D7/629
D947,611 S * 4/2022 Lown D7/510
D948,293 S * 4/2022 Wahl D7/608
2015/0173539 A1 * 6/2015 Mason B65D 47/063
220/707
2016/0318693 A1 * 11/2016 Hein B65D 81/3841
2017/0273484 A1 * 9/2017 Spivey B65D 47/0833
2021/0002041 A1 * 1/2021 Starner B65D 47/32

FOREIGN PATENT DOCUMENTS

CN 306668283 * 7/2021
GB 6094166 * 7/2020
GB 6094173 * 7/2020
JP D1642982 * 10/2019
JP D1704600 * 2/2022
JP D1704654 * 2/2022
JP D1705302 * 2/2022
JP D1705358 * 2/2022
JP D1708183 * 2/2022
JP D1713899 * 4/2022
JP D1713915 * 4/2022
JP D1713946 * 4/2022
JP D1713948 * 4/2022
KR 301030549.0000 * 11/2019
KR 301115395.0000 * 6/2021
KR 3011144250001 * 6/2021
KR 3011232540002 * 8/2021

OTHER PUBLICATIONS

Thermos [online] URL: <https://www.walgreens.com/store/c/thermos-kids-hard-plastic-hydration-bottle-w/-straw-and-silicone-sleeve-assortment-12-oz./ID=300410776-product> (site visited: Jan. 25, 2022) (Year: 2022).*

Wellness [online] URL: <https://www.sears.com/wellness-insulated-double-wall-water-bottles-w-handle/p-A048354172> (site visited: Jan. 25, 2022) (Year: 2022).*

Kula [online] URL: <https://www.amazon.ca/gp/product/B01N75RB1K> (site visited: Mar. 31, 2022) (Year: 2016).*

Docooler [online] URL: <https://www.amazon.com/Docooler-Portable-Ultralight-Camping-Outdoor/dp/B07GXVD9VV> (site visited: Mar. 31, 2022) (Year: 2018).*

Stanley [online] URL: <https://www.amazon.ca/Stanley-Stainless-Insulated-Reusable-Leakproof/dp/B08RXSMRNB> (site visited: Mar. 31, 2022) (Year: 2021).*

MISC Wellness [online] URL: <https://www.amazon.com/MISC-Wellness-Insulated-Bottle-Handle/dp/B08F37WFTL> (site visited: May 11, 2022) (Year: 2022).*

* cited by examiner

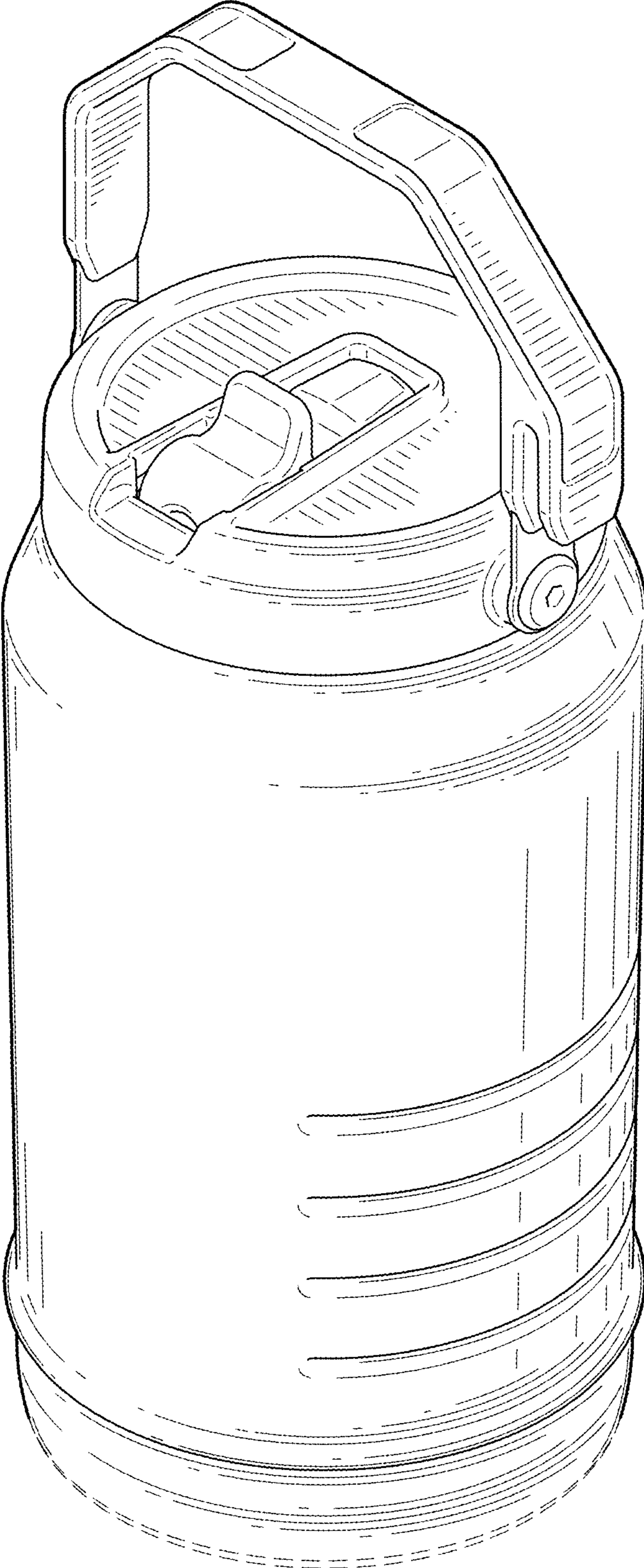

FIG. 1

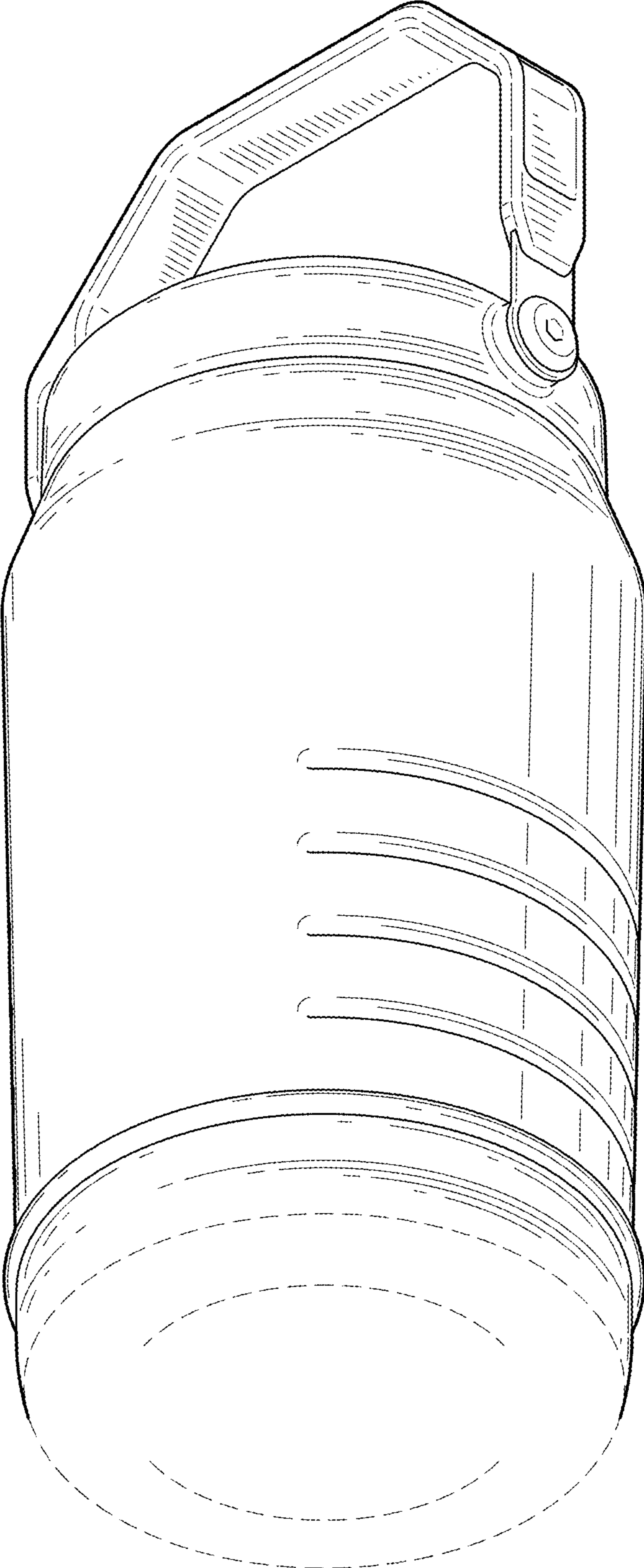

FIG. 2

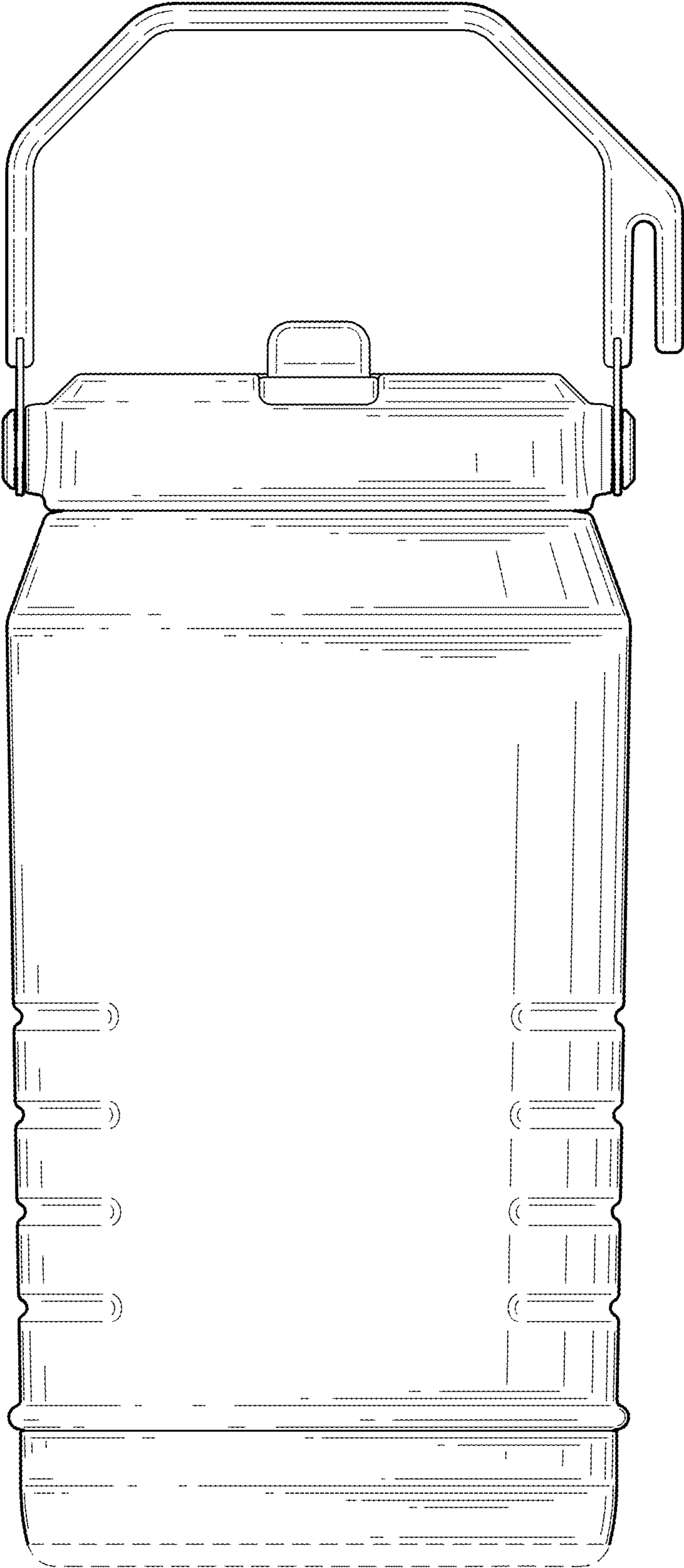

FIG. 3

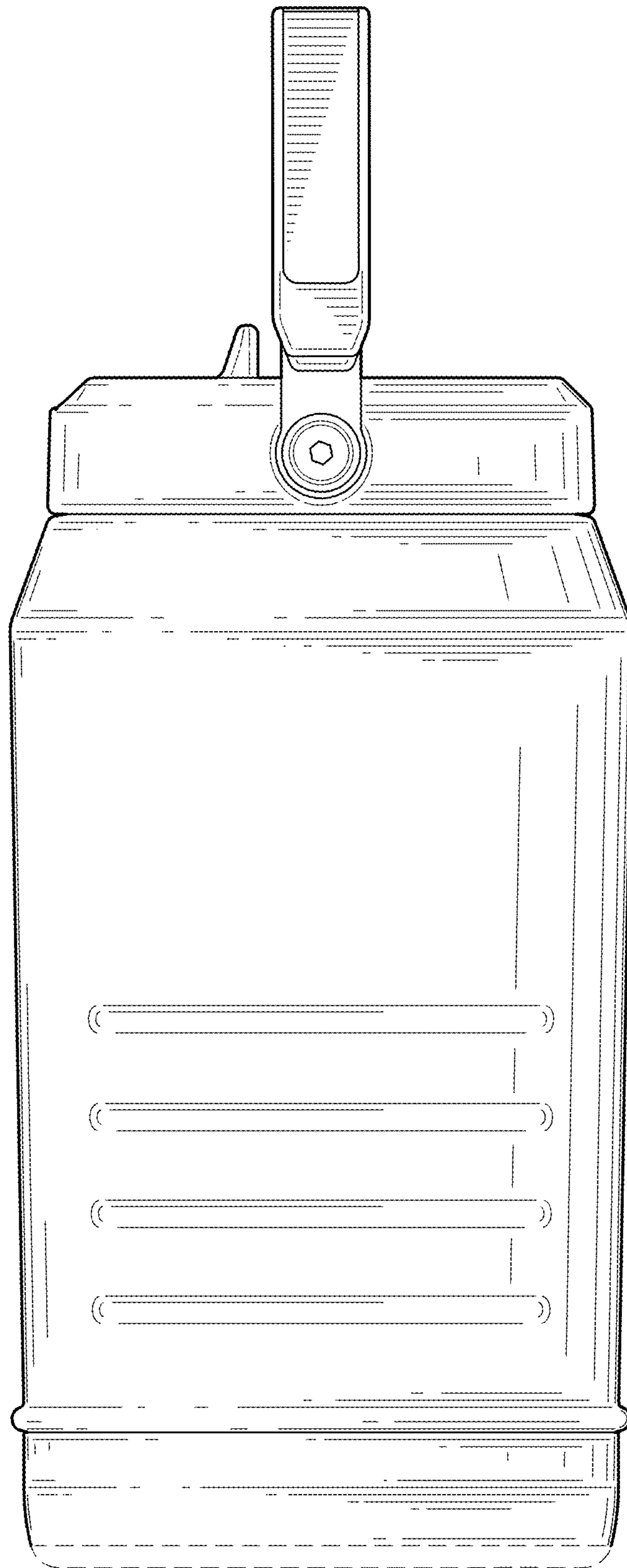

FIG. 4

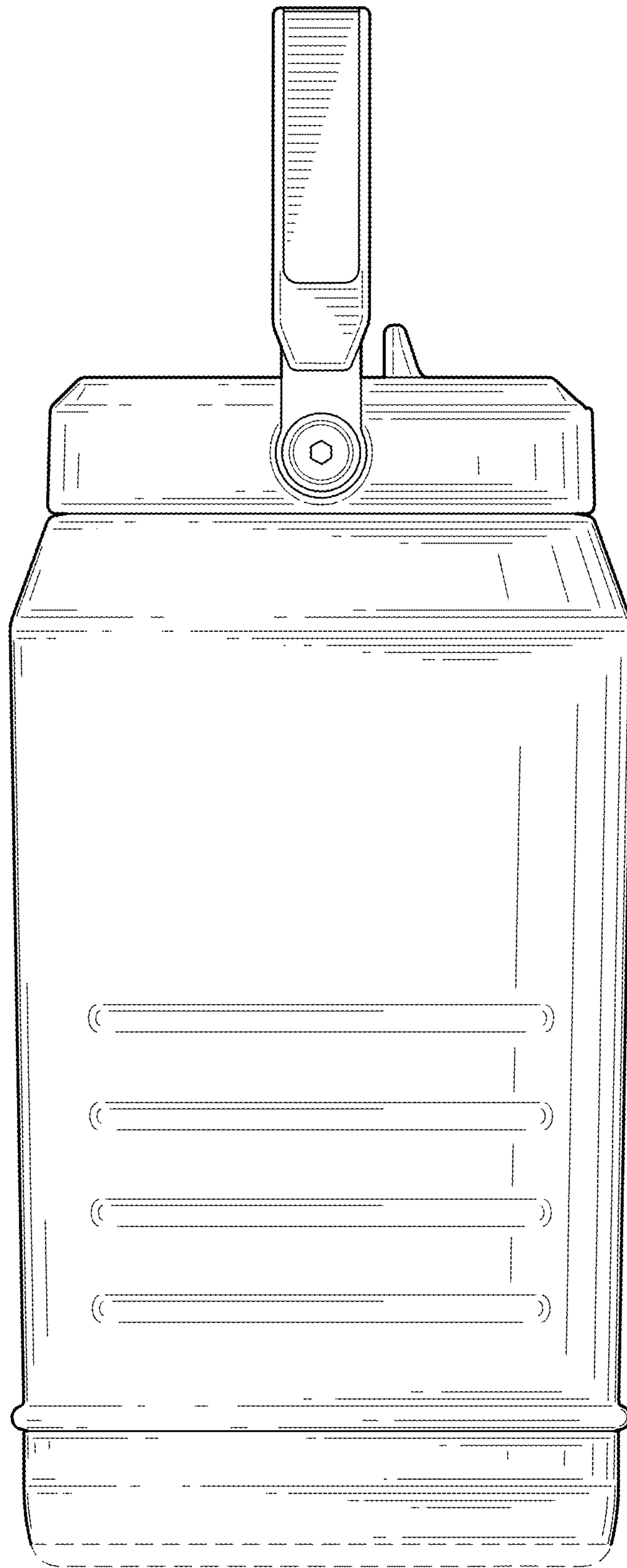

FIG. 5

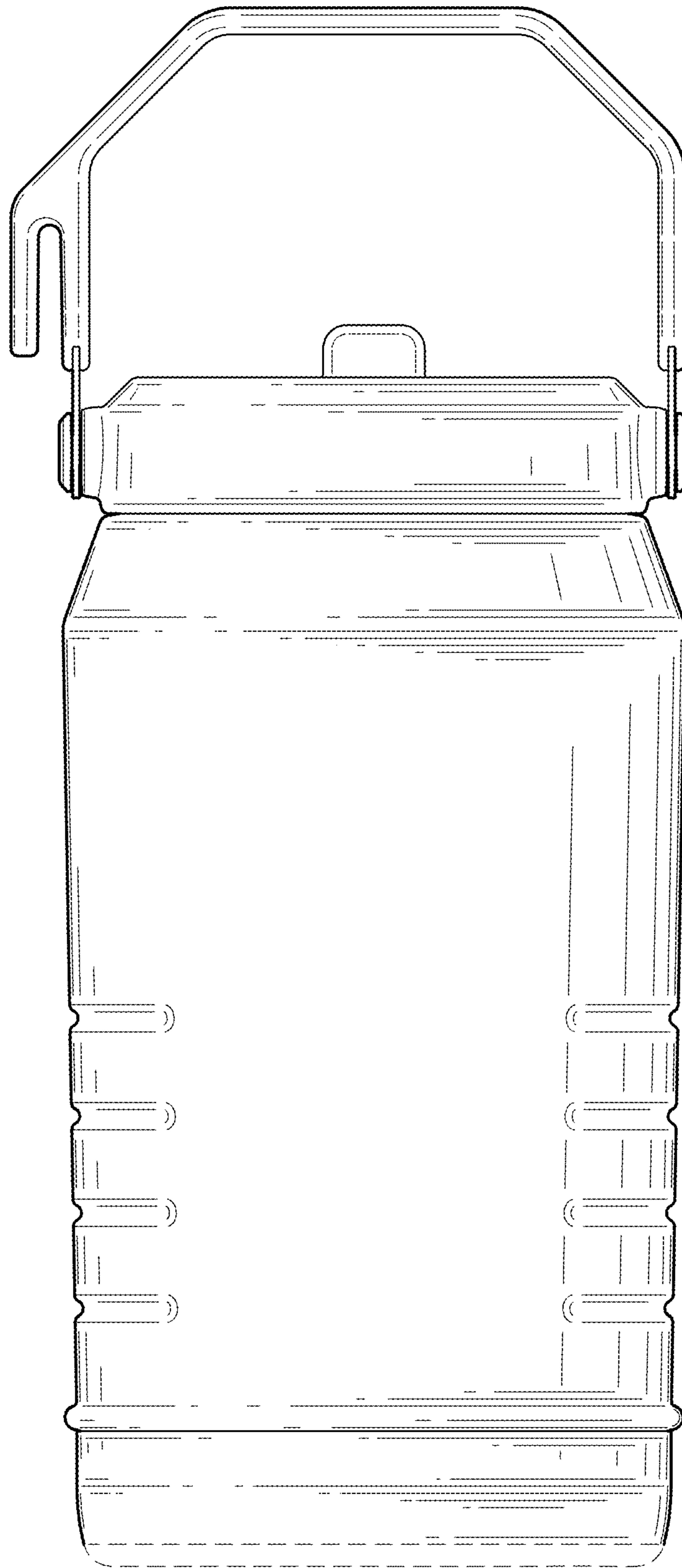

FIG. 6

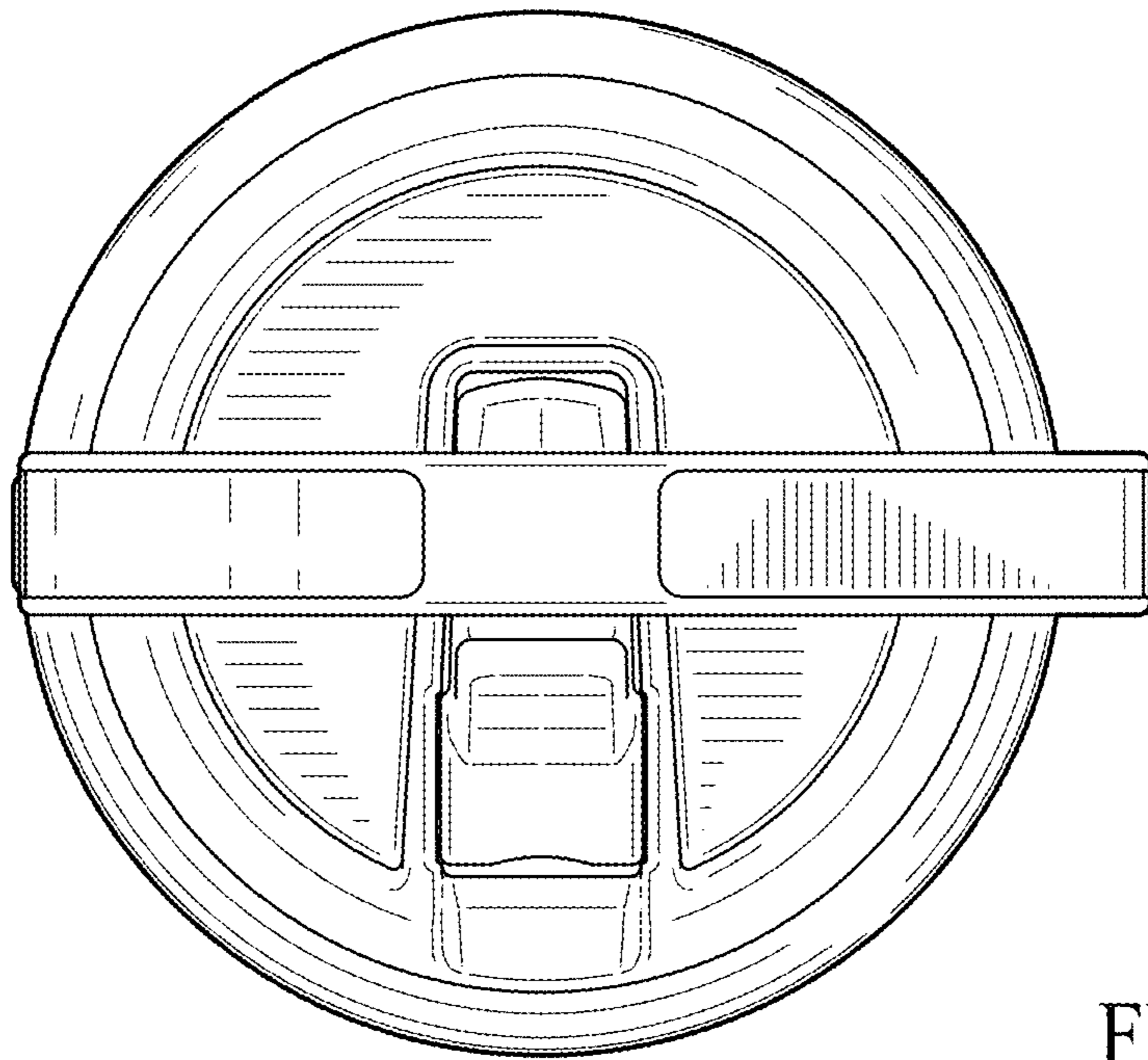

FIG. 7

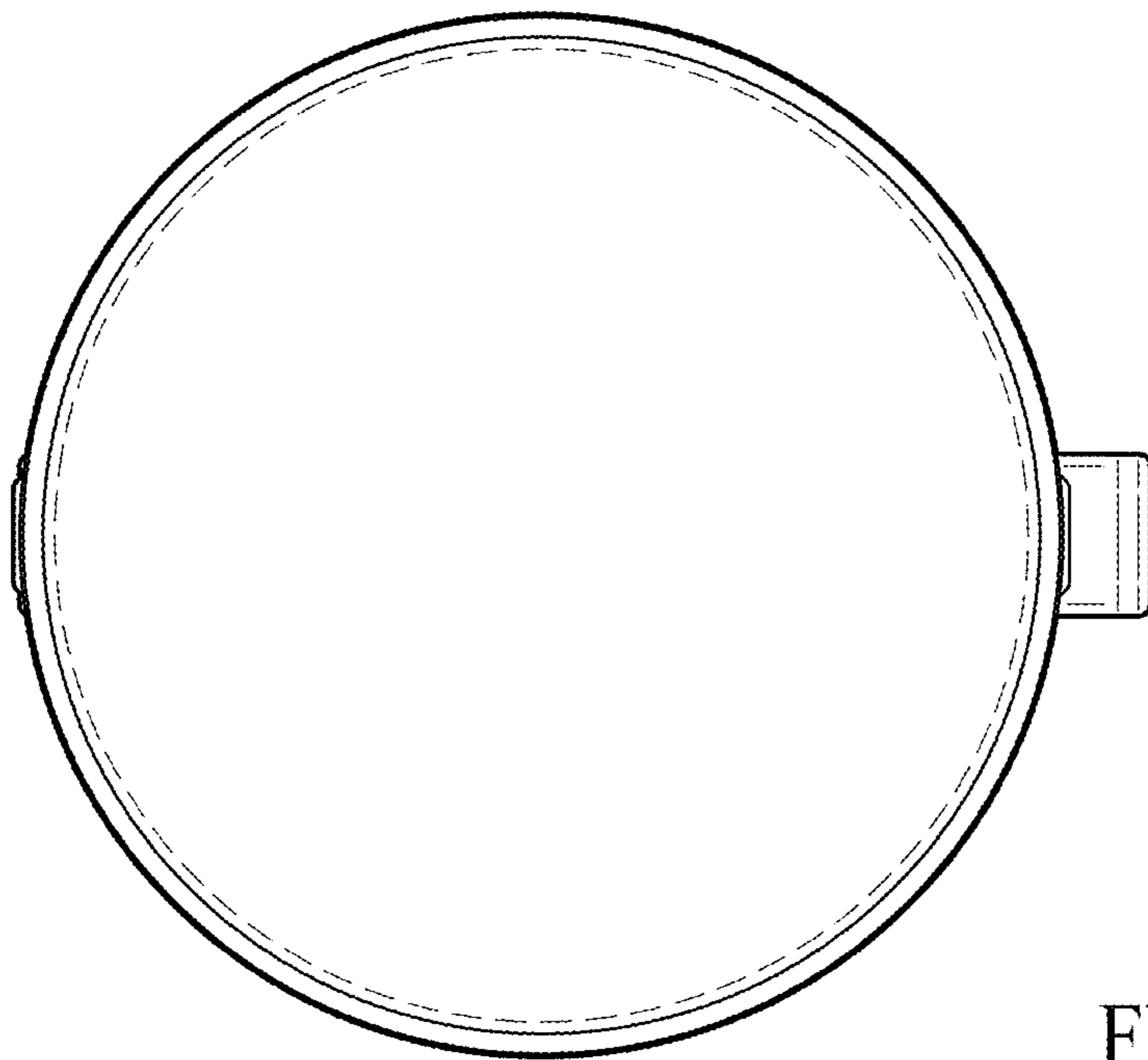

FIG. 8

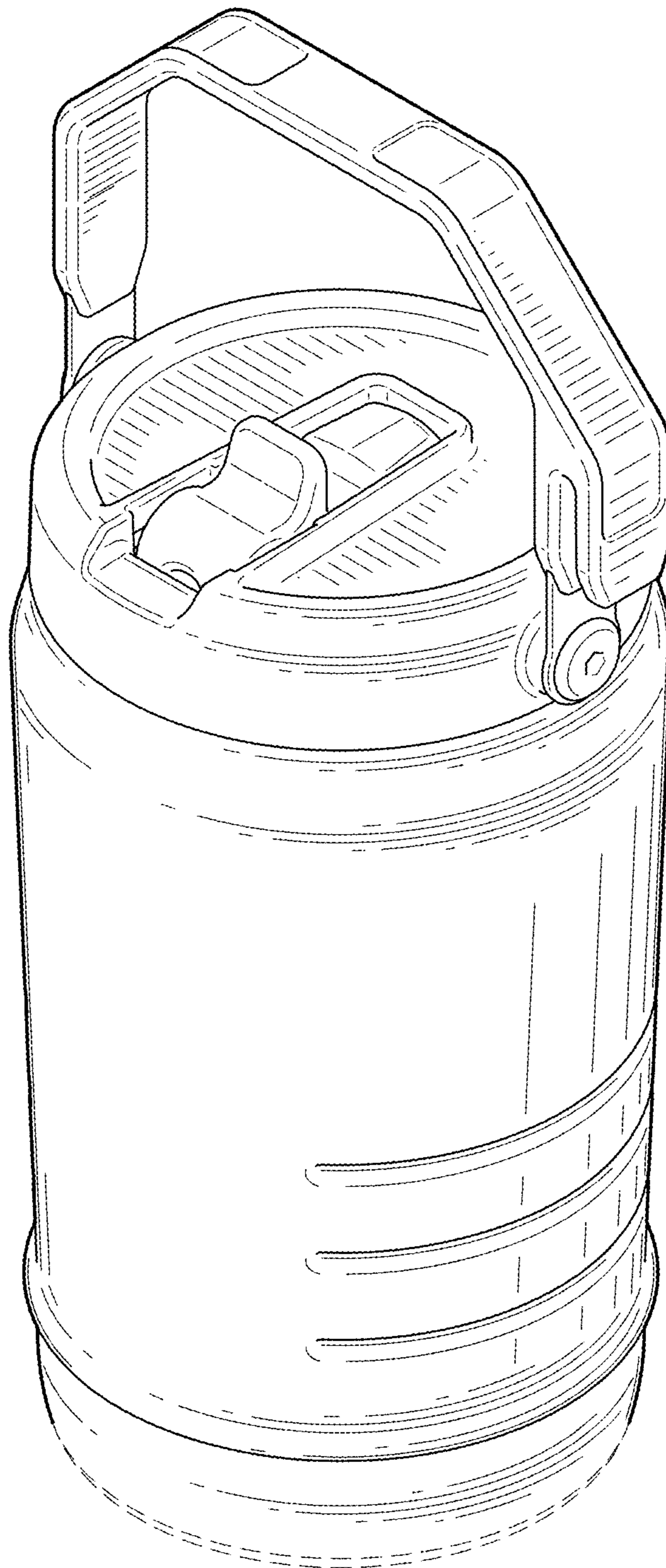

FIG. 9

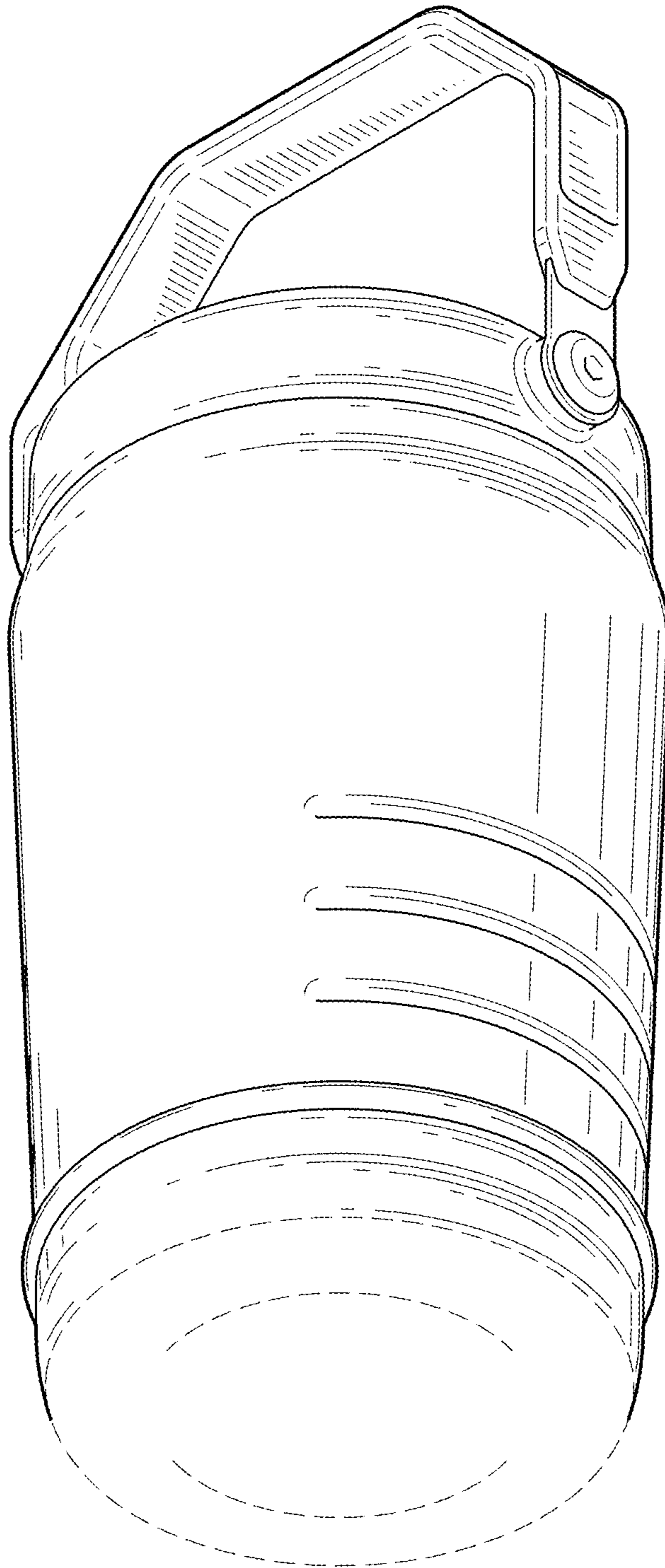

FIG. 10

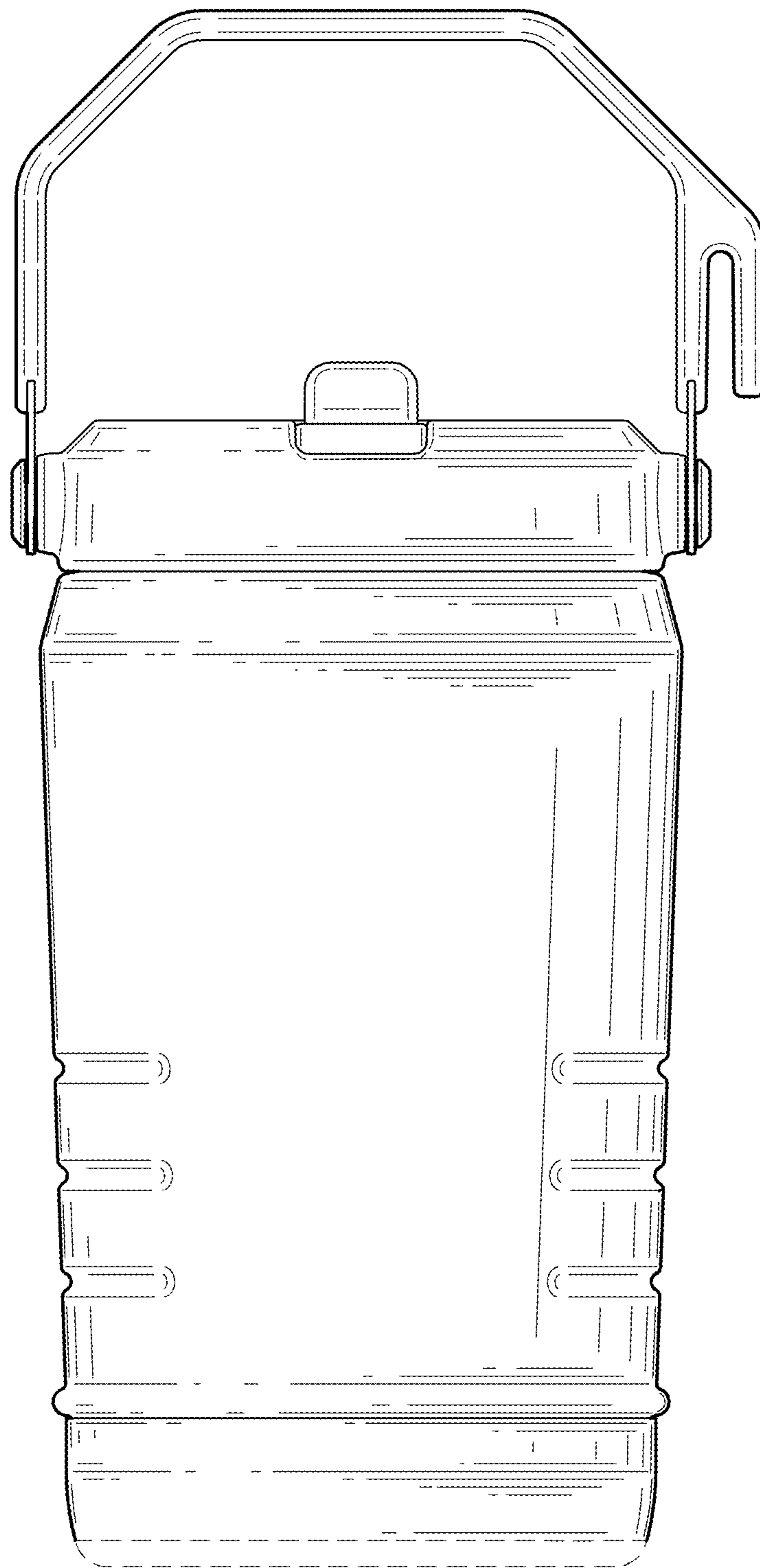

FIG. 11

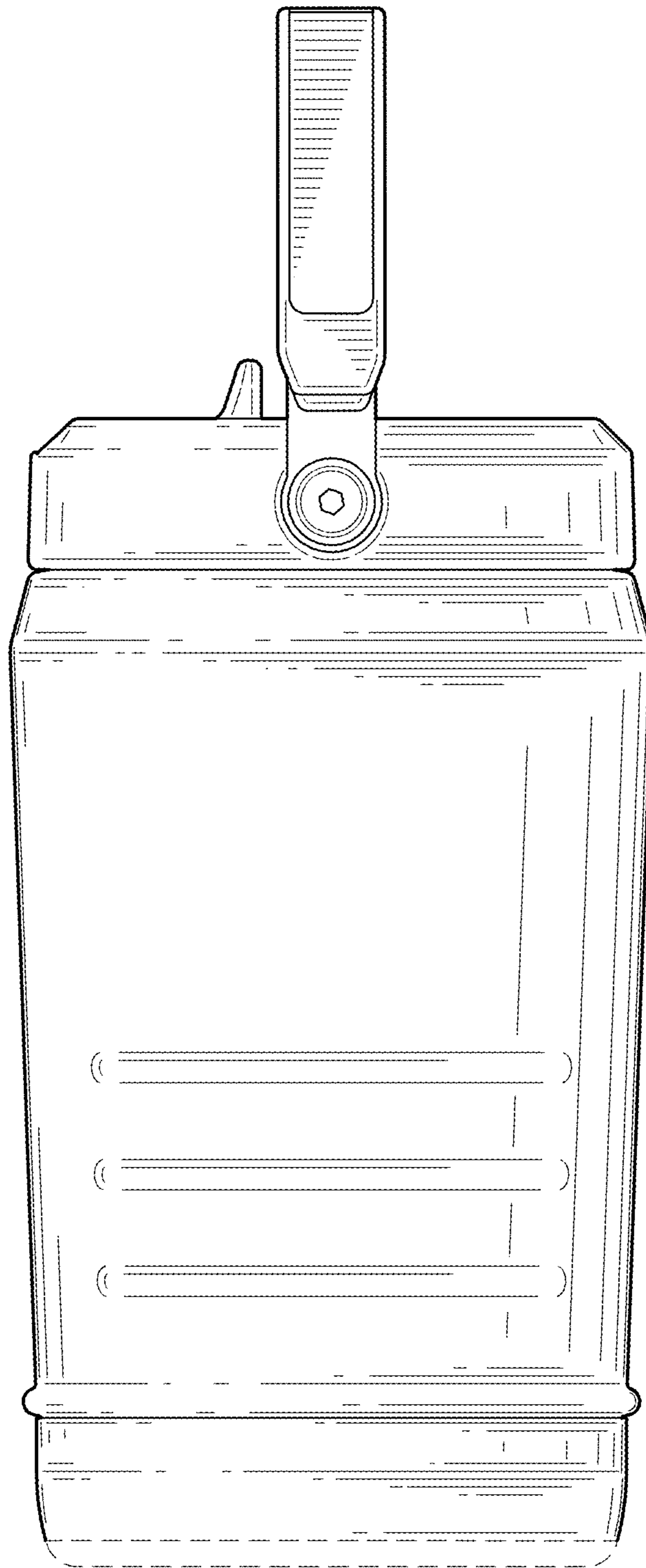

FIG. 12

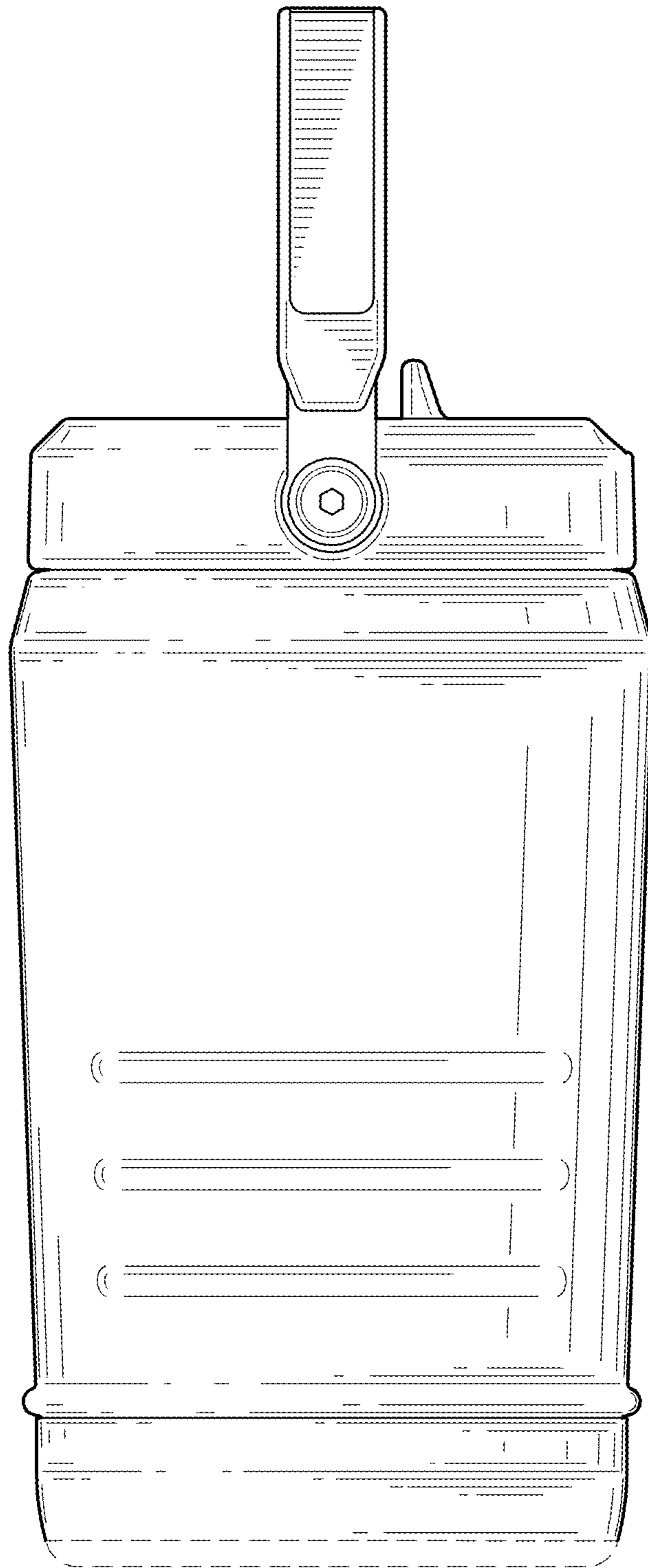

FIG. 13

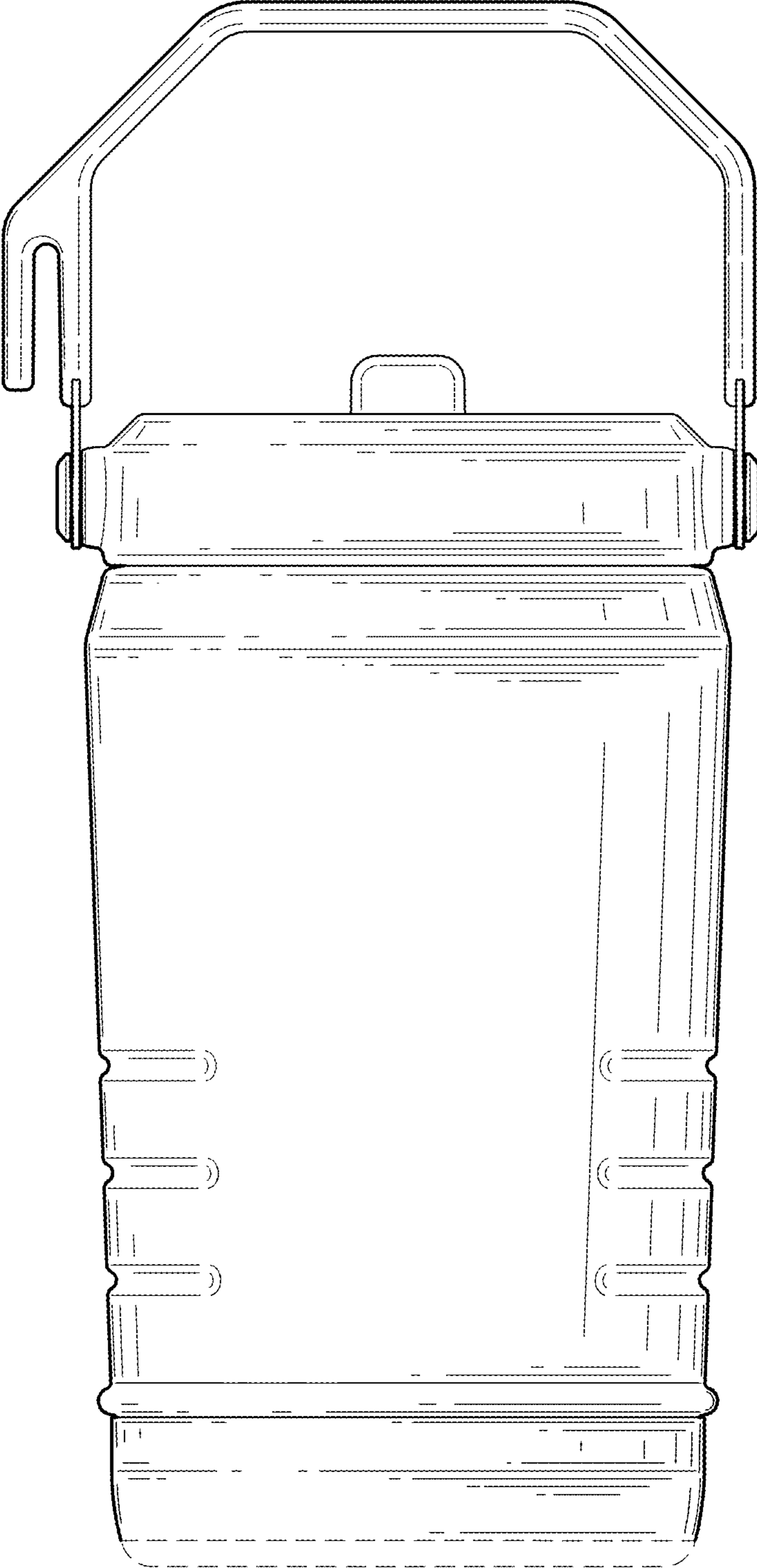

FIG. 14

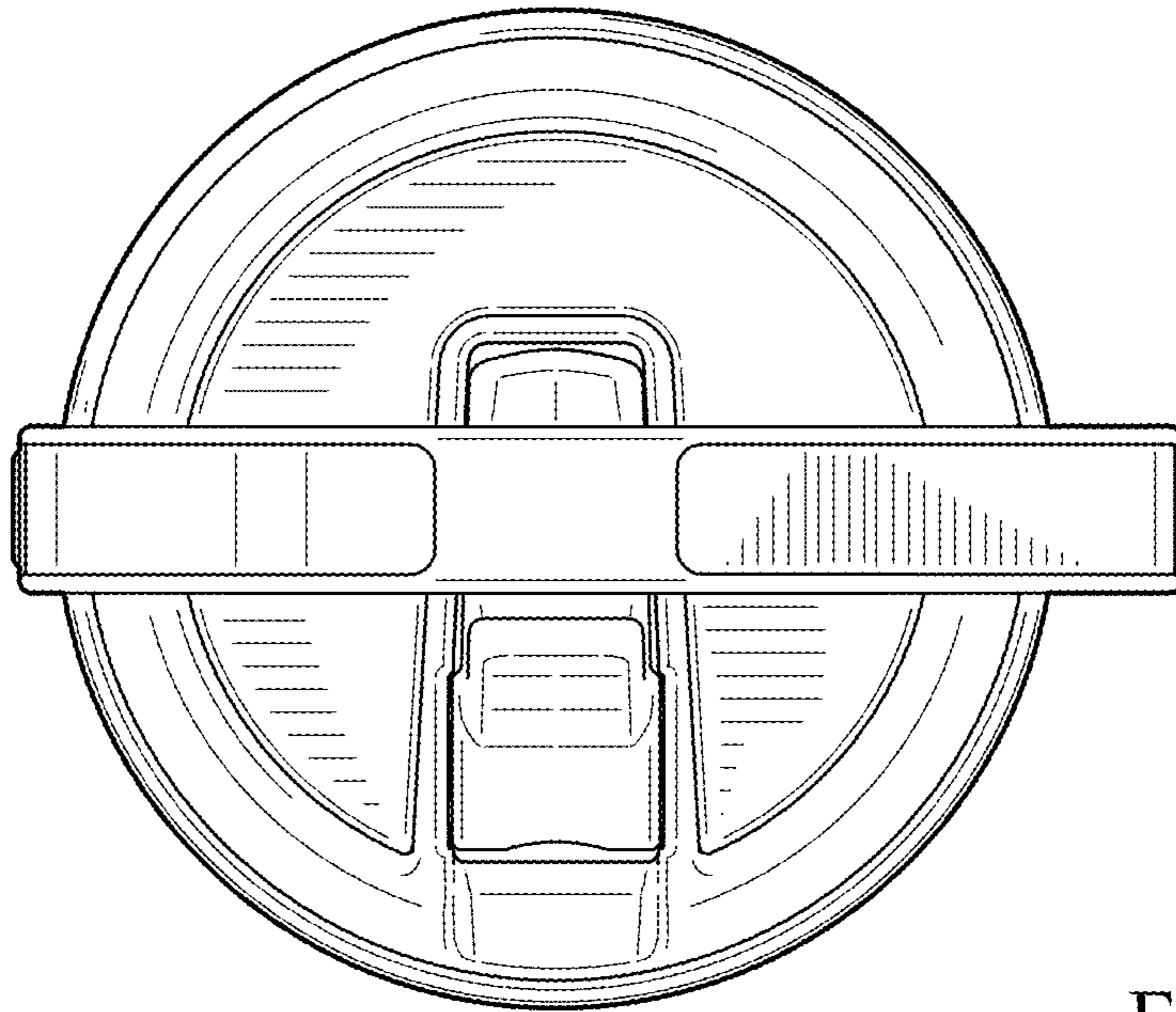

FIG. 15

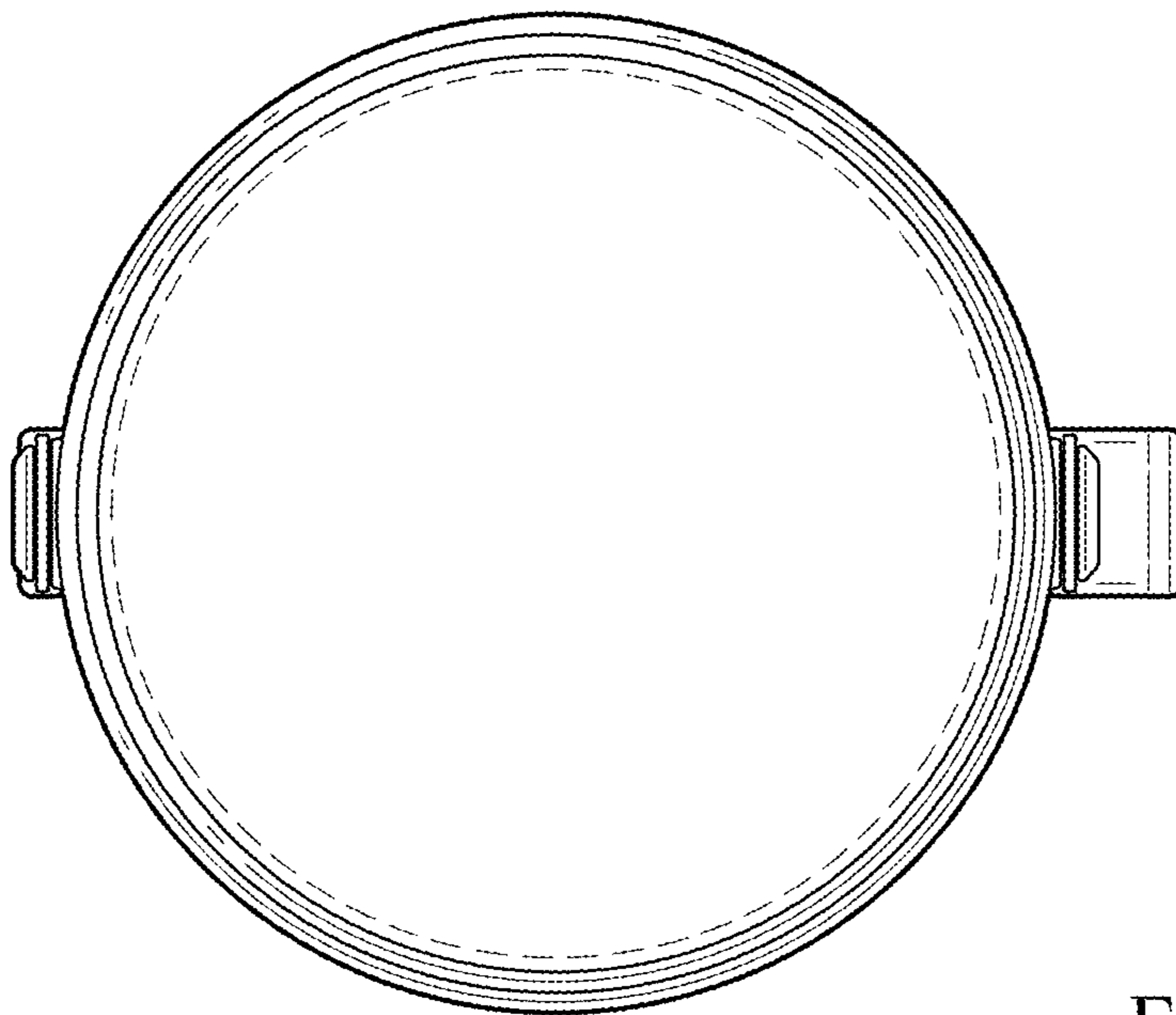

FIG. 16