



US00D962685S

(12) **United States Design Patent** (10) **Patent No.:** **US D962,685 S**
Parikh (45) **Date of Patent:** **** *Sep. 6, 2022**

(54) **TABLE**
(71) Applicant: **Williams-Sonoma, Inc.**, San Francisco, CA (US)
(72) Inventor: **Andrea Parikh**, Brooklyn, NY (US)
(73) Assignee: **Williams-Sonoma, Inc.**, San Francisco, CA (US)

(*) Notice: This patent is subject to a terminal disclaimer.

(**) Term: **15 Years**

(21) Appl. No.: **29/745,308**

(22) Filed: **Aug. 5, 2020**

(51) **LOC (13) Cl.** **06-03**

(52) **U.S. Cl.**
USPC **D6/691.5**

(58) **Field of Classification Search**
USPC D6/686, 690, 691, 691.3, 656.17, 691.1, D6/691.5, 691.6
CPC .. A47B 3/00; A47B 3/002; A47B 3/08; A47B 3/0812; A47B 3/0818; A47B 3/0912; A47B 2003/006; A47B 2003/0821; A47B 7/00; A47B 13/00; A47B 13/02; A47B 13/04; A47B 13/06; A47B 13/08; A47B 21/00; A47B 2200/0001; A47B 2200/0011; A47B 2200/002; A47B 2200/0035; A47B 2200/005; A47B 13/10; A47B 13/12; A47B 17/00; A47B 17/003; A47B 17/06; A47B 21/0314; A47B 2021/0307; A47B 2021/0321; A47B 2021/0335; A47B 2200/0003; A47B 2200/0004; A47B 47/0058; A47B 11/00; A47B 3/06; A47B 7/0091; A47B 7/0025; A47B 7/0058; A47B 7/0008

See application file for complete search history.

(56) **References Cited**

U.S. PATENT DOCUMENTS

D99,565 S * 5/1936 Talbert D6/656.16
D113,215 S * 2/1939 Birkmeyer D6/691.5

2,943,898 A * 7/1960 Knuth F16B 12/52
108/156
D225,950 S * 1/1973 Kienel D6/691.5
D225,951 S * 1/1973 Kienel D6/691.5
D247,080 S * 1/1978 Robinson D6/690

(Continued)

FOREIGN PATENT DOCUMENTS

CN 304069169 * 9/2016
KR 300319957 * 3/2003

OTHER PUBLICATIONS

Live Edge Walnut Table by Loewen Design Studios, first available: Jun. 4, 2021. Etsy.com [online], [site visited Nov. 26, 2021], Internet URL: <https://www.etsy.com/listing/708453894/live-edge-walnut-table-with-walnut-panel> (Year: 2021).*

(Continued)

Primary Examiner — Steven J Czyz
Assistant Examiner — Hillary Catherine Shepard
(74) *Attorney, Agent, or Firm* — Cook Alex Ltd.

(57) **CLAIM**

The ornamental design for a table, as shown and described.

DESCRIPTION

FIG. 1 is a perspective view of a table;
FIG. 2 is a front elevational view thereof;
FIG. 3 is a rear elevational view thereof;
FIG. 4 is a left side elevational view thereof, the opposite side of which is a mirror image;
FIG. 5 is a top plan view thereof; and,
FIG. 6 is a bottom plan view thereof.
The broken lines depicts portions of the article that form no part of the claimed design.

1 Claim, 5 Drawing Sheets

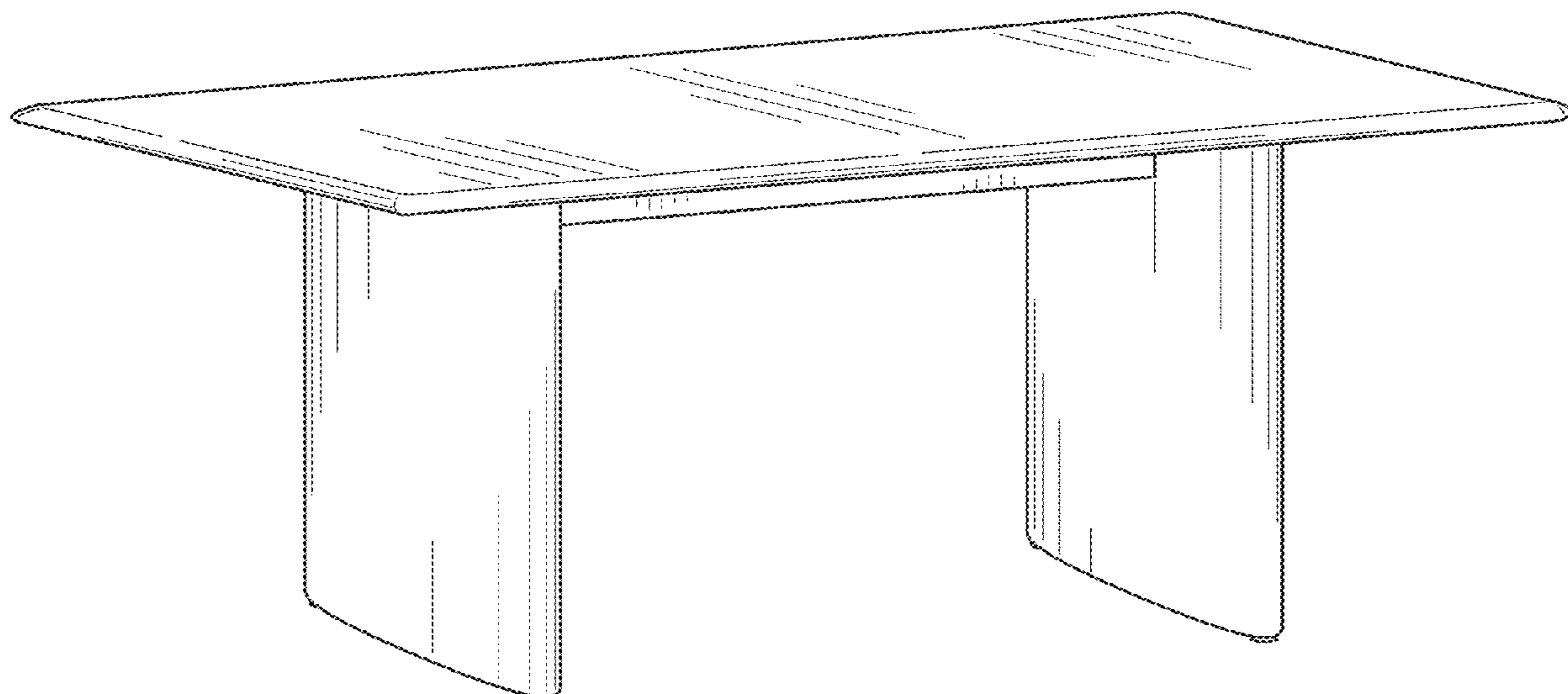

(56)

References Cited

U.S. PATENT DOCUMENTS

D249,216 S * 9/1978 Blaser D6/708
 D270,411 S * 9/1983 DeGregori D6/691.5
 D308,615 S * 6/1990 Hubert D6/691.1
 D347,945 S * 6/1994 Walters-Leiter D6/353
 D362,140 S * 9/1995 Pedersen D6/691.5
 D386,631 S * 11/1997 Meier D6/656.1
 D415,360 S * 10/1999 Lewis D6/349
 D456,643 S * 5/2002 Harner D6/691.5
 D466,337 S * 12/2002 Feng D6/689
 D505,282 S * 5/2005 Miyakawa D6/691.8
 D553,394 S * 10/2007 Geraghty D6/692
 D583,577 S * 12/2008 Wicha D6/349
 D604,063 S * 11/2009 Oshinomi D6/656.16
 8,096,244 B1 * 1/2012 Bockheim A47B 87/002
 108/64
 D668,893 S * 10/2012 Lehman-Smith D6/708
 D693,610 S * 11/2013 Denby D6/690
 D711,171 S * 8/2014 Brielmaier D6/675
 D727,644 S * 4/2015 Sorel D6/349
 D733,465 S * 7/2015 Parisi D6/656
 D765,450 S * 9/2016 Biddle D6/691
 D781,086 S * 3/2017 Velez D6/691
 D794,982 S 8/2017 Palma
 D817,036 S 5/2018 Palma
 D833,182 S * 11/2018 Yamamoto D6/656.17
 D833,785 S * 11/2018 Baylar D6/691.4
 D853,161 S 7/2019 Parikh
 D880,879 S * 4/2020 Kirn D6/349
 D882,996 S 5/2020 Hale
 D884,400 S * 5/2020 Chen D6/705

D888,444 S * 6/2020 Kimmel D6/349
 D926,504 S * 8/2021 Van Faasen D6/691
 D948,901 S * 4/2022 Velez D6/691.5

OTHER PUBLICATIONS

Coco Table by Bielefelder Werkstaetten, first available: unknown. Architonic.com [online], [site visited Nov. 26, 2021], Internet URL: <https://www.architonic.com/en/product/bielefelder-werkstaetten-coco-table/20061164> (Year: 2021).*

Natural Wood Dining Table by Leanne Ford, first available: unknown. crateandbarrel.com [online], [site visited Nov. 26, 2021], Internet URL: <https://www.crateandbarrel.com/van-natural-wood-dining-table-by-leanne-ford/s501526> (Year: 2021).*

Solid Wood Dining Table by Studio McGee, first available: Jul. 30, 2021. Target.com [online], [site visited Nov. 26, 2021], Internet URL: <https://www.target.com/p/bell-canyon-solid-wood-dining-table-threshold-designed-with-studio-mcgee/-/A-82117639> (Year: 2021).*

Reclaimed Elm Dining Table by Blue Hand Home, first available: Unknown. Bluehandhome.com [online], [site visited Nov. 26, 2021], Internet URL: <https://www.bluehandhome.com/products/reclaimed-elm-2-leg-plank-table-84> (Year: 2021).*

Anton Dining Table by West Elm, first available: Sep. 15, 2019. Instagram.com [online], [site visited Dec. 3, 2021], Internet URL: https://www.instagram.com/p/B2c2SOLjVO2/?utm_medium=copy_link (Year: 2019) (Year: 2019).*

Anton Dining Table by West Elm, first available: Oct. 22, 2019. Instagram.com [online], [site visited Dec. 3, 2021], Internet URL: https://www.instagram.com/p/B2c2SOLjVO2/?utm_medium=copy_link (Year: 2019) (Year: 2019).*

* cited by examiner

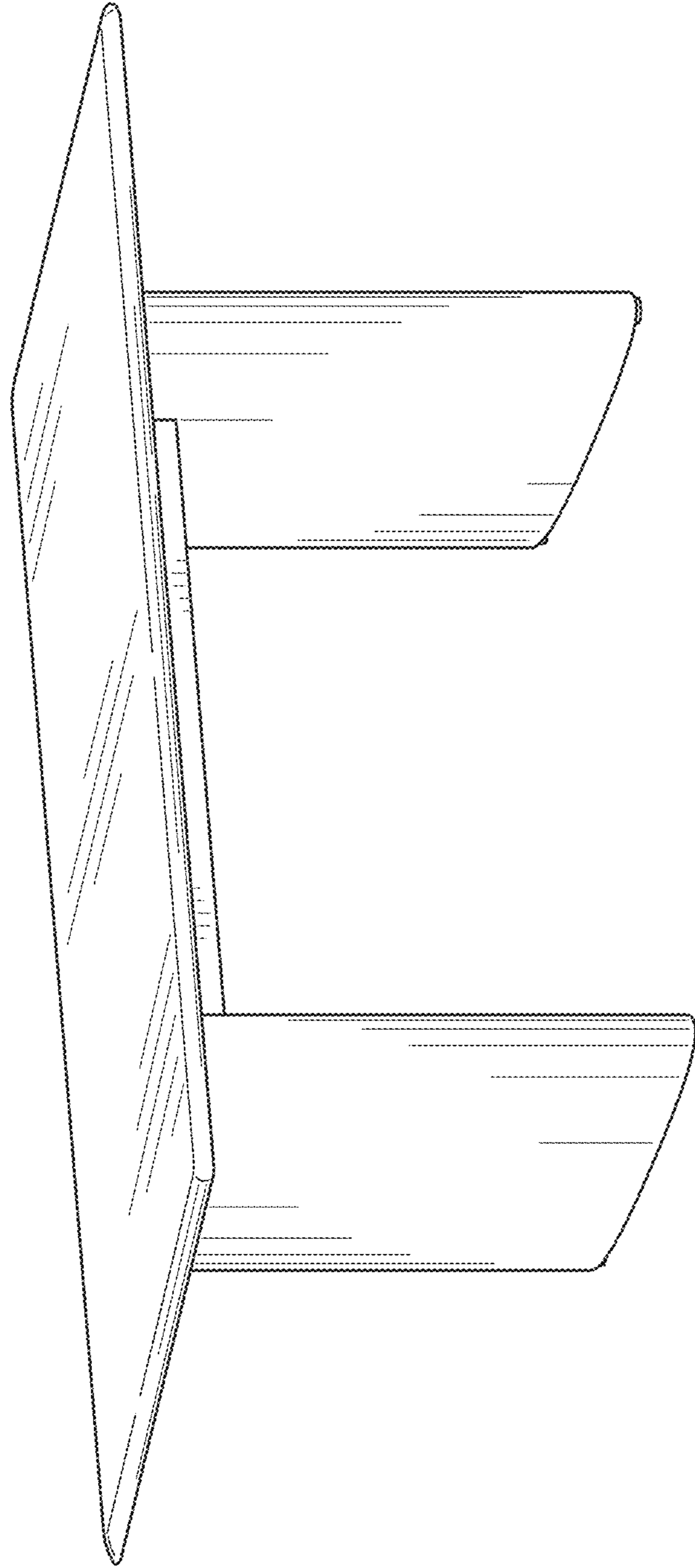

FIG. 1

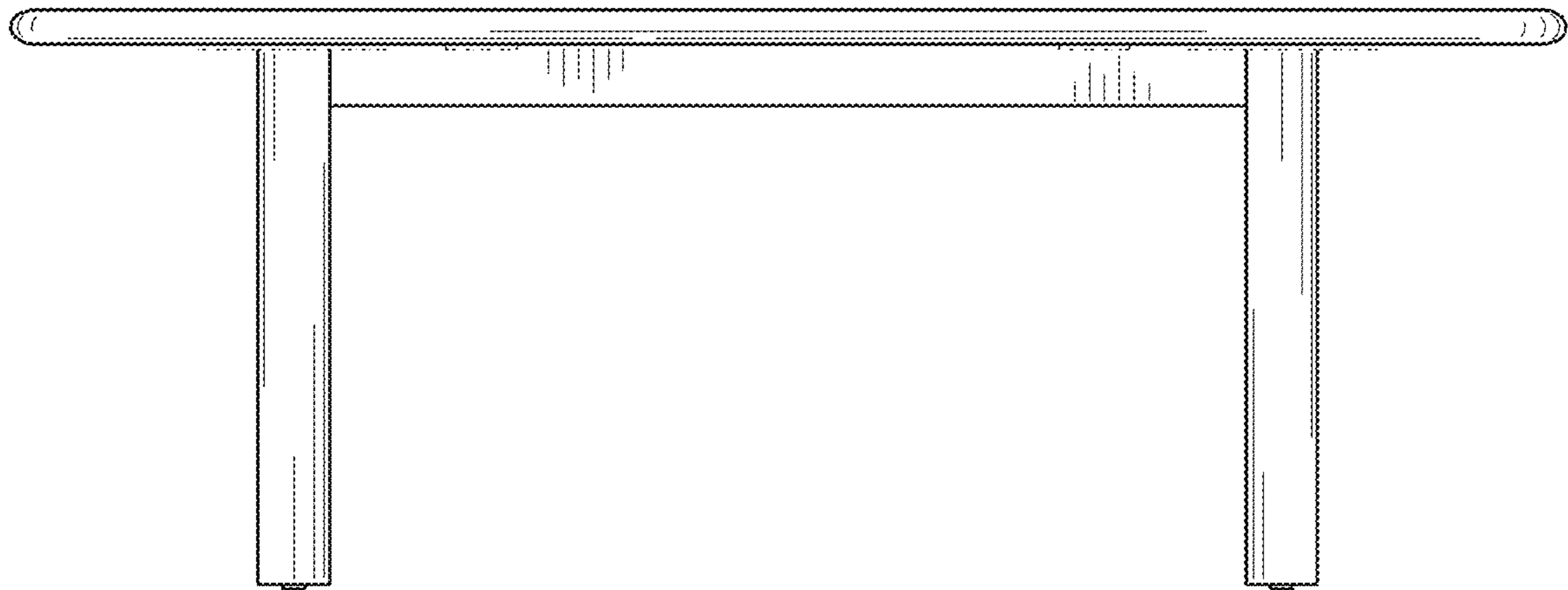

FIG. 2

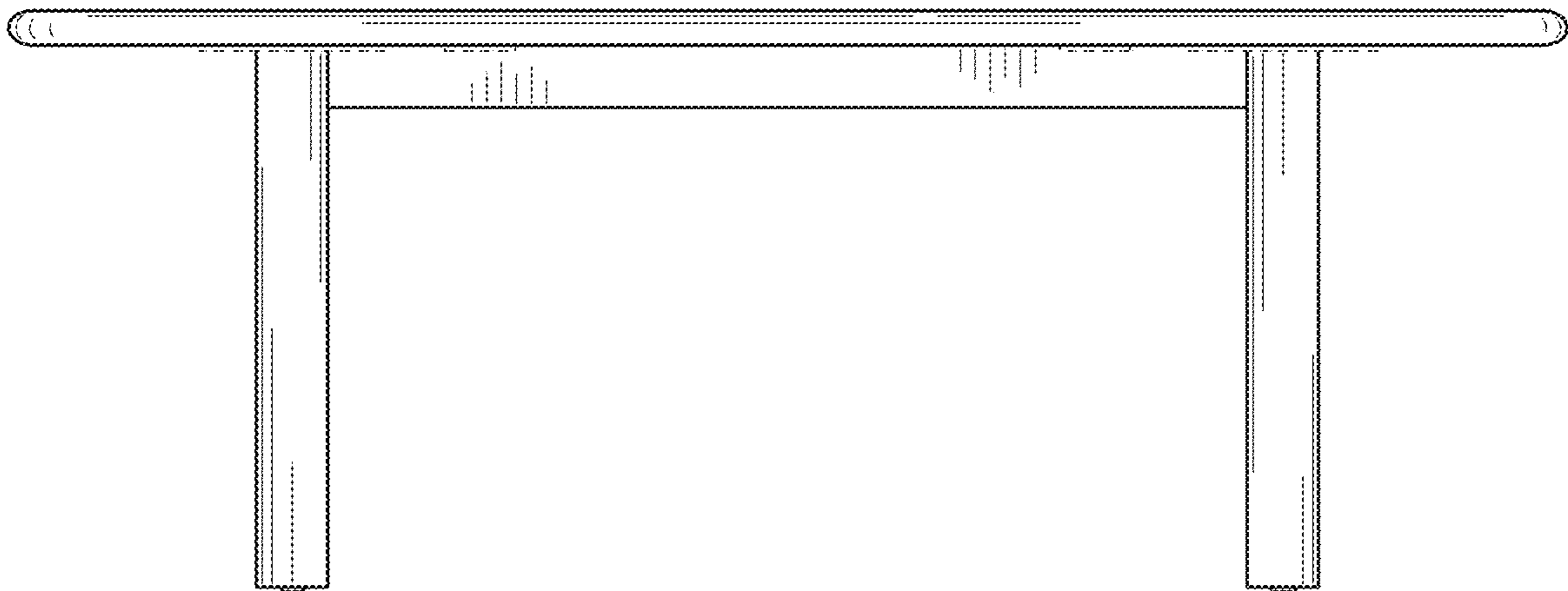

FIG. 3

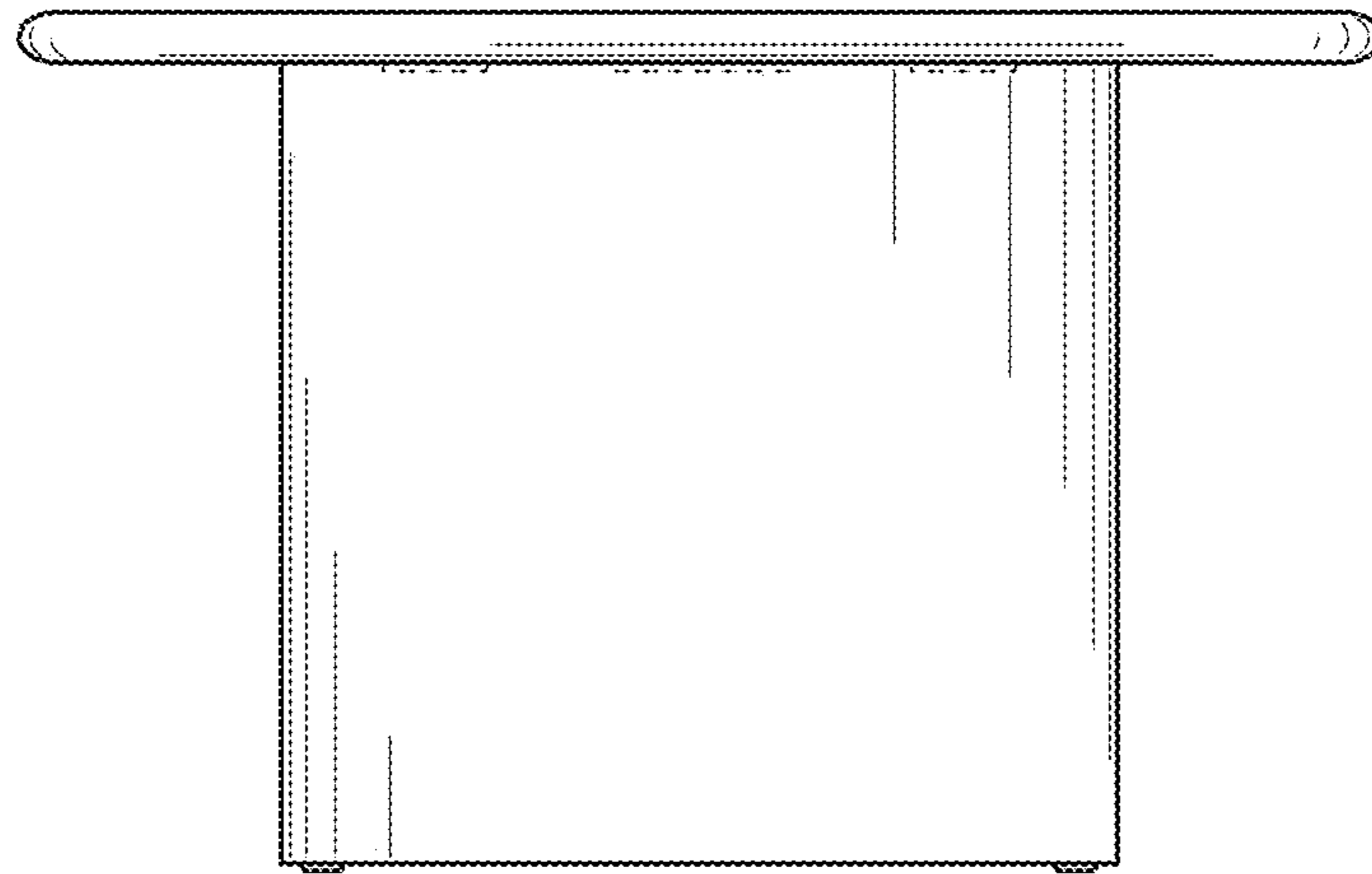

FIG. 4

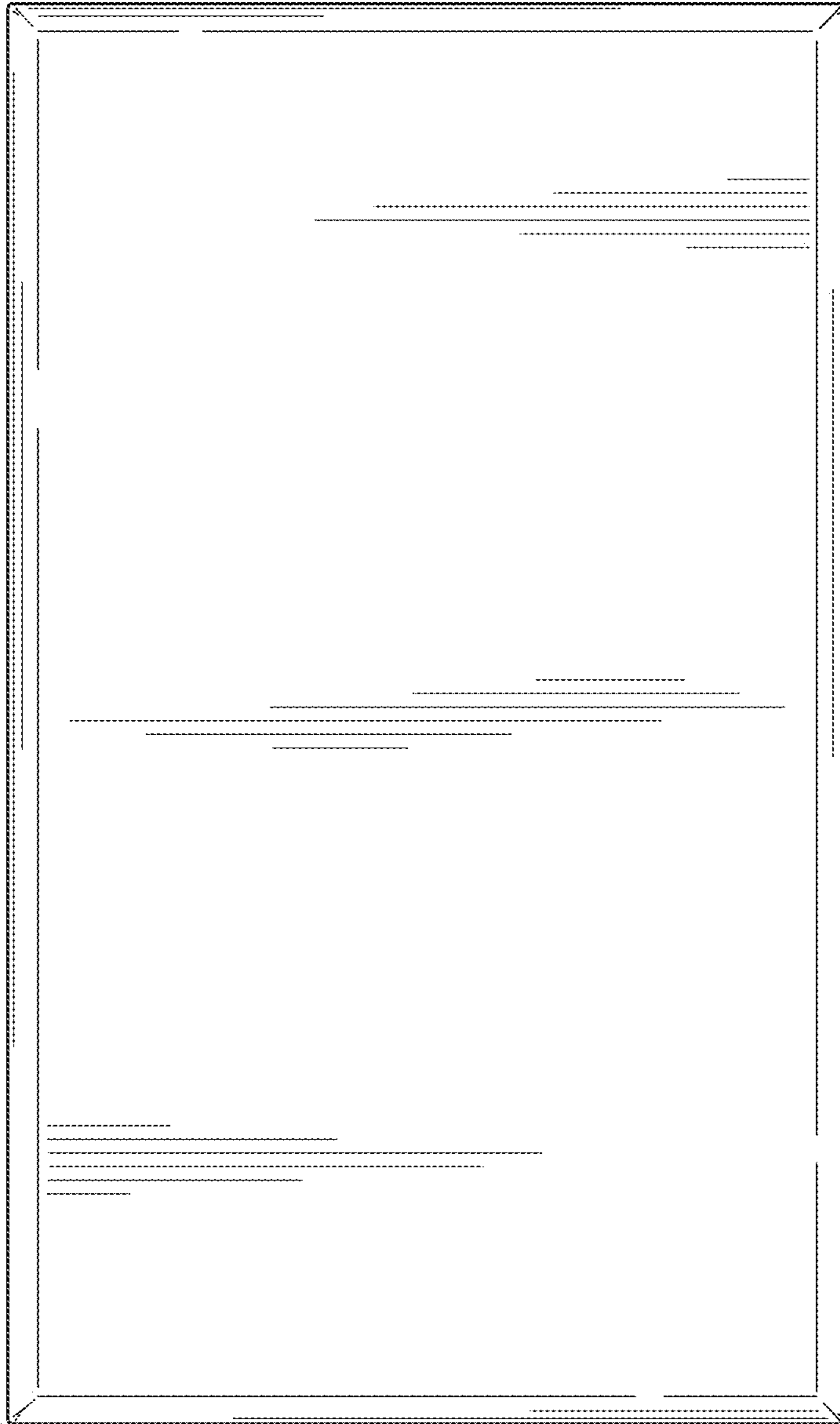

FIG. 5

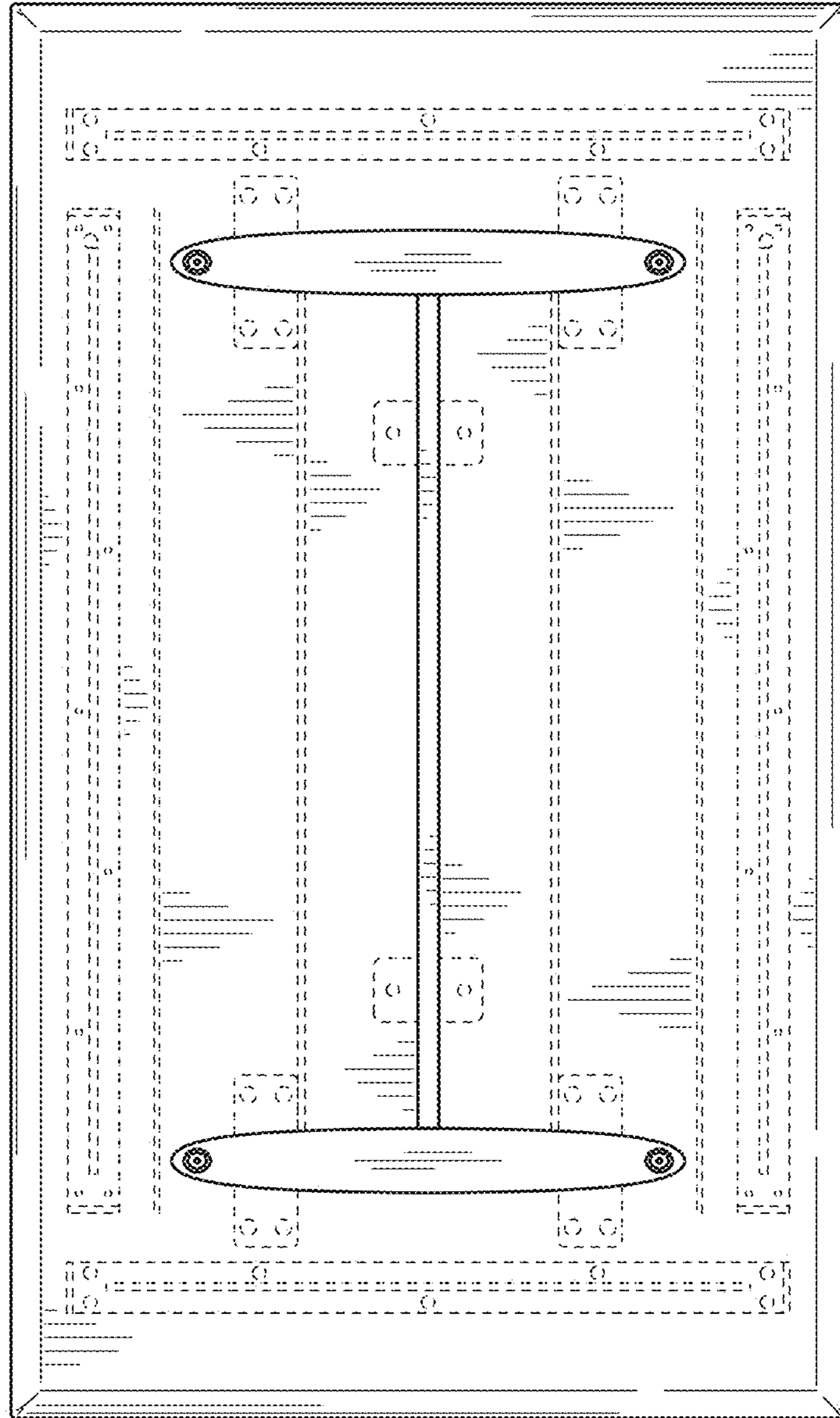

FIG. 6