

US00D962648S

(12) **United States Design Patent** (10) **Patent No.:** **US D962,648 S**
Ladwig et al. (45) **Date of Patent:** **** Sep. 6, 2022**

(54) **ORAL IRRIGATOR HANDLE**

(71) Applicant: **WATER PIK, INC.**, Fort Collins, CO (US)

(72) Inventors: **Jeff Ladwig**, Seattle, WA (US);
Zebrick Roach, Seattle, WA (US)

(73) Assignee: **WATER PIK, INC.**, Fort Collins, CO (US)

(**) Term: **15 Years**

(21) Appl. No.: **29/744,441**

(22) Filed: **Jul. 29, 2020**

(51) **LOC (13) Cl.** **04-02**

(52) **U.S. Cl.**
USPC **D4/100**

(58) **Field of Classification Search**
USPC D4/100, 101, 102, 103, 104, 107, 109,
D4/110, 111, 113, 127, 128, 129
CPC A46B 9/04; A46B 2200/1066; A46B
2200/1073; A46B 13/023; A46B 5/0095;
A61C 17/16; A61C 17/222
See application file for complete search history.

D825,741 S 8/2018 Massie et al.
D840,022 S 2/2019 Porter et al.
D844,997 S 4/2019 Au et al.
D845,636 S 4/2019 Porter et al.
10,258,442 B2 4/2019 Snyder et al.
D870,268 S 12/2019 Massie et al.
D877,324 S 3/2020 Massie et al.
D880,688 S 4/2020 Kim
D881,584 S 4/2020 Porter et al.
D891,784 S * 8/2020 Okai D4/101
D912,802 S * 3/2021 Williams D24/111
D922,074 S * 6/2021 Okai D4/101
D947,366 S * 3/2022 Massie D24/111
2018/0168784 A1 6/2018 Wagner et al.
2018/0168785 A1 6/2018 Wagner et al.
2018/0263742 A1 9/2018 Taylor et al.

* cited by examiner

Primary Examiner — Cynthia Ramirez
Assistant Examiner — Tamara L Hahn
(74) *Attorney, Agent, or Firm* — Dorsey & Whitney LLP

(57) **CLAIM**

We claim the ornamental design for an oral irrigator handle, as shown and described.

DESCRIPTION

FIG. 1 is a front isometric view of an oral irrigator handle.
FIG. 2 is a rear isometric view thereof.
FIG. 3 is a front elevation view thereof.
FIG. 4 is a rear elevation view thereof.
FIG. 5 is a right side elevation view thereof.
FIG. 6 is a left side elevation view thereof.
FIG. 7 is a top plan view thereof; and,
FIG. 8 is a bottom plan view thereof.
The broken lines illustrate portions of the oral irrigator handle that form no part of the claimed design.

1 Claim, 4 Drawing Sheets

(56) **References Cited**
U.S. PATENT DOCUMENTS

D574,952 S 8/2008 Boyd et al.
8,808,209 B2 8/2014 Boyd et al.
D717,427 S 11/2014 Kim et al.
D754,330 S 4/2016 Kim et al.
D782,657 S 3/2017 Williams
D783,809 S 4/2017 Au et al.
D783,810 S 4/2017 Kim et al.
10,022,207 B2 7/2018 Taylor et al.

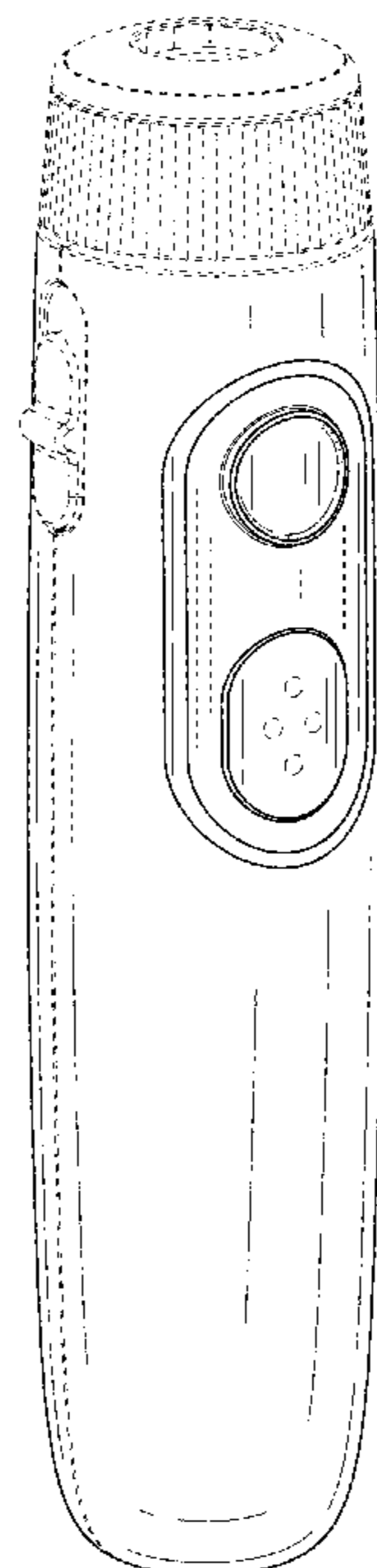

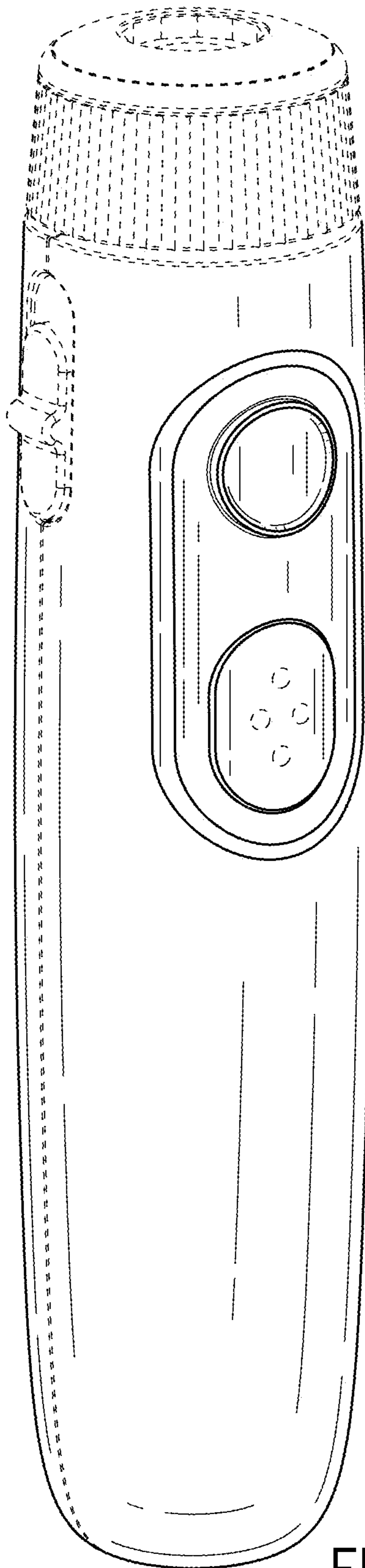

FIG. 1

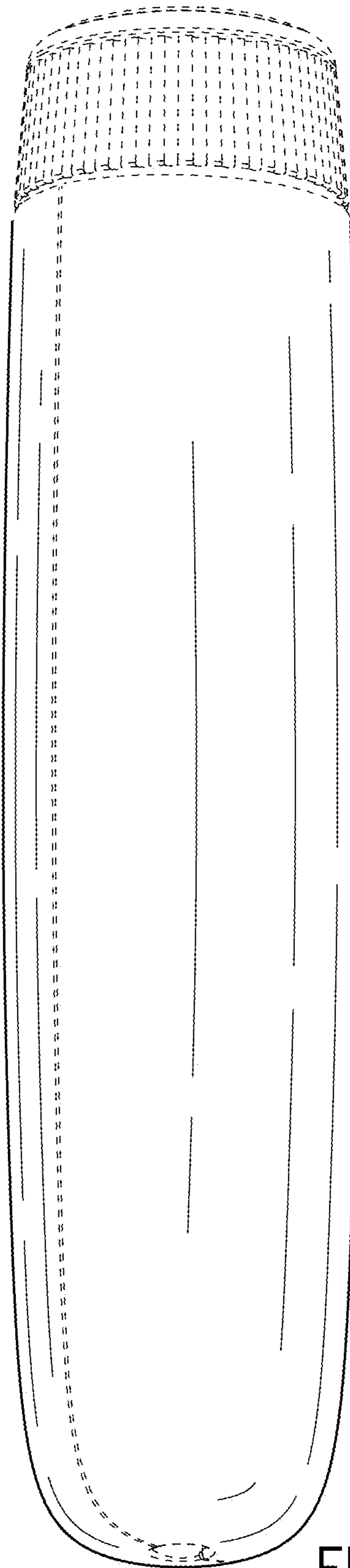

FIG. 2

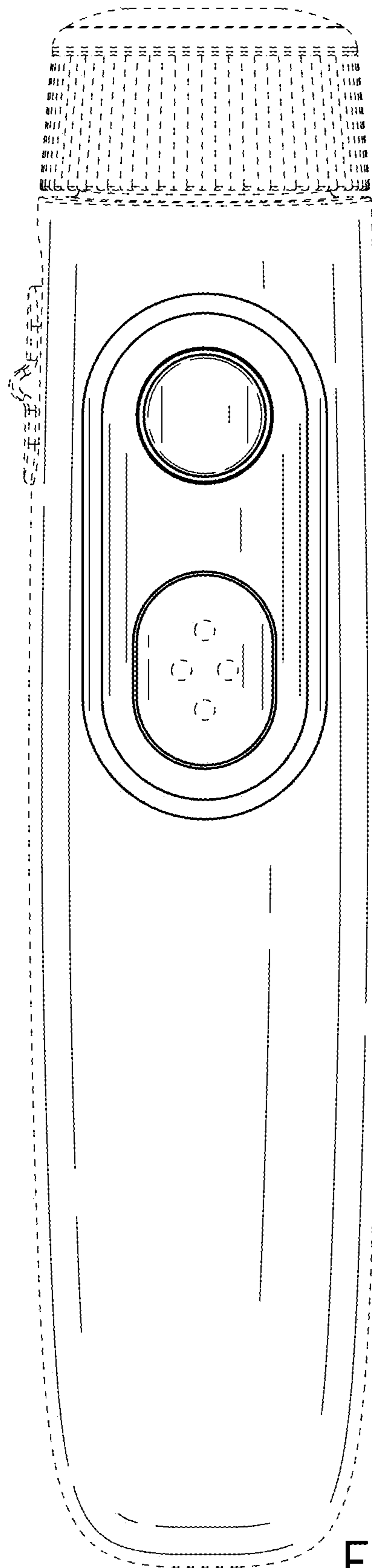

FIG. 3

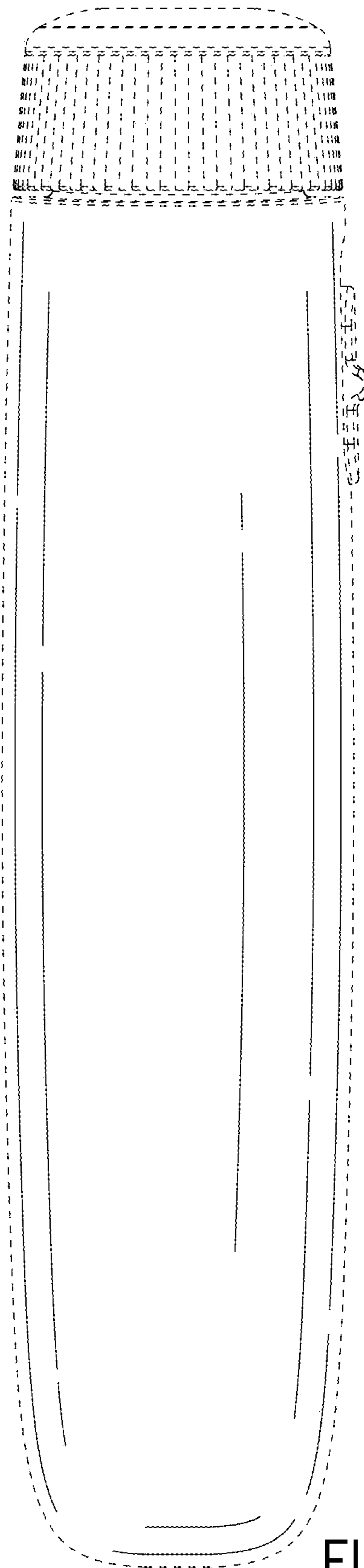

FIG. 4

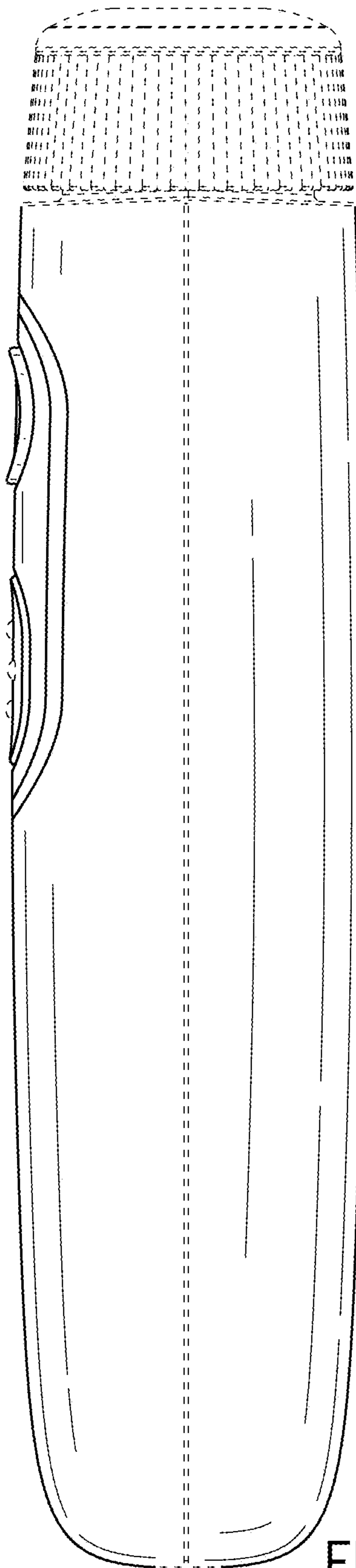

FIG. 5

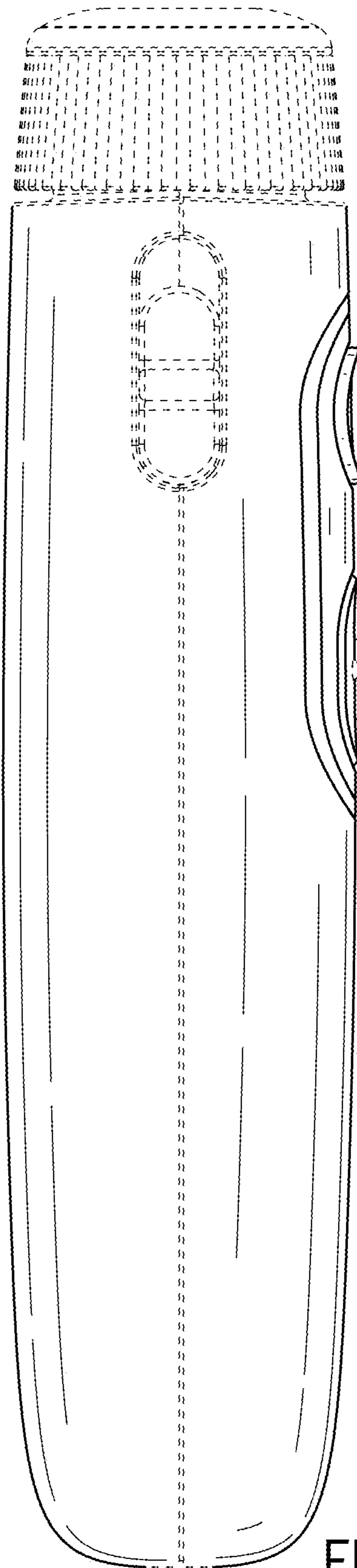

FIG. 6

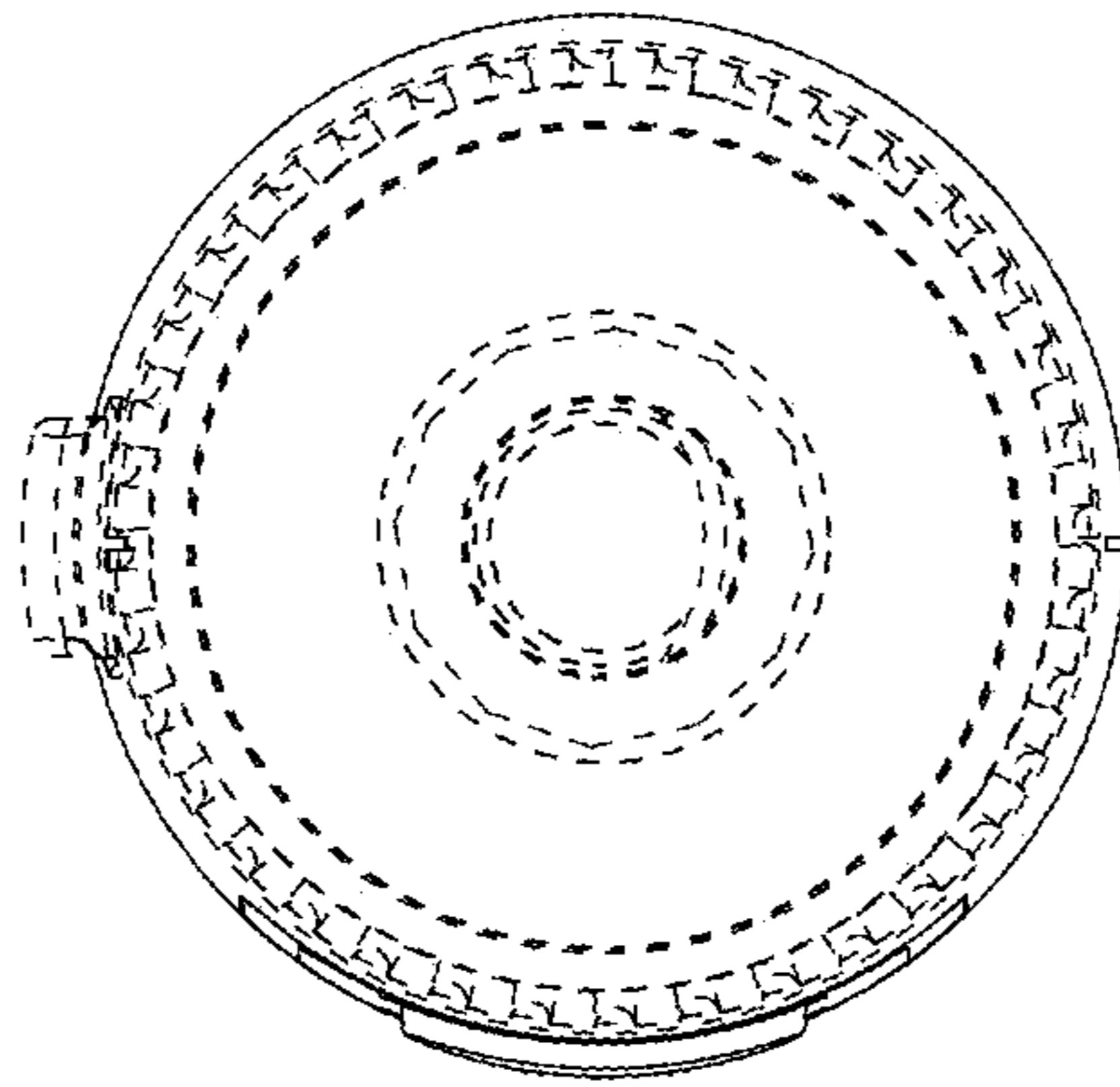

FIG. 7

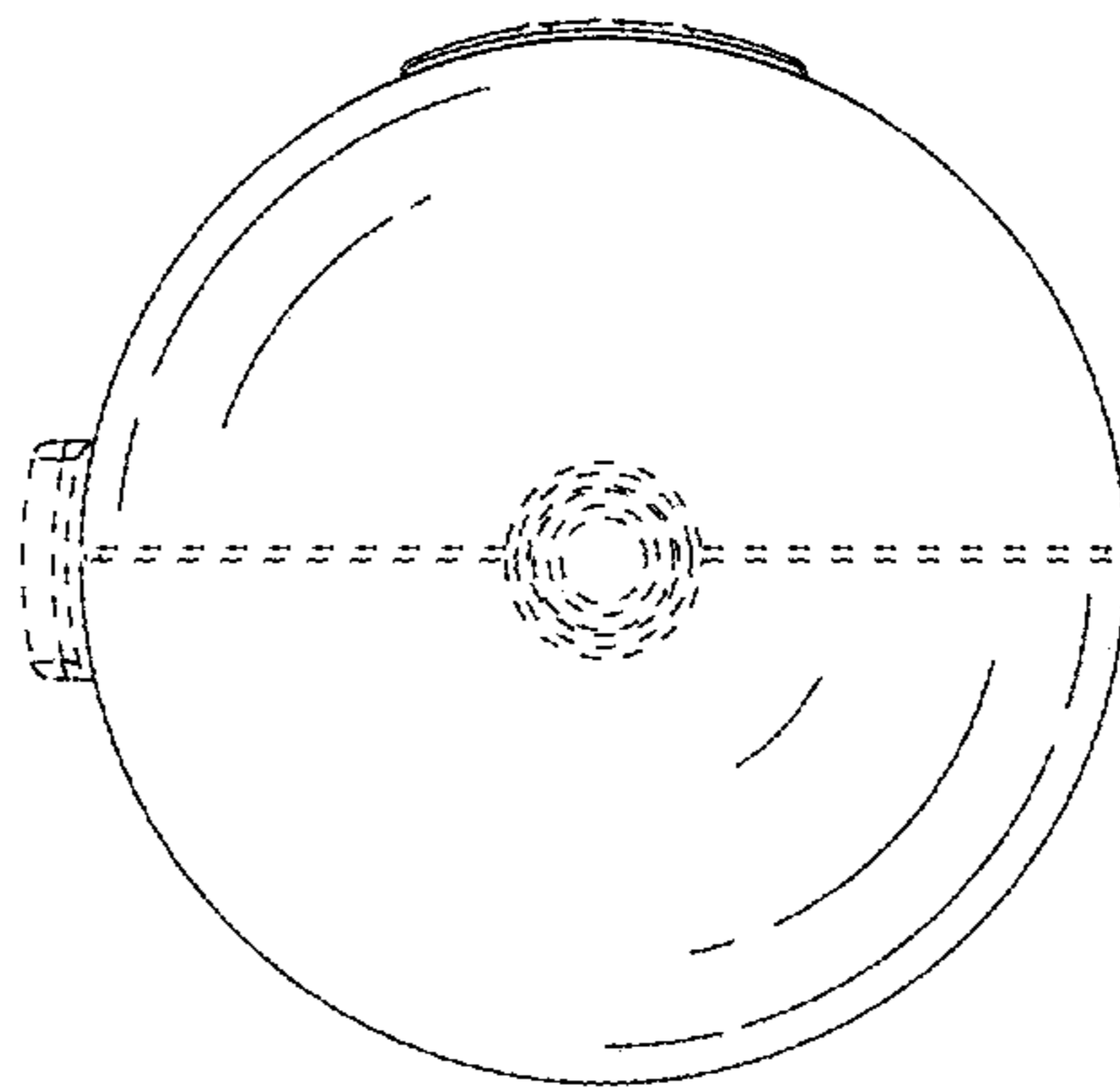

FIG. 8