



US00D962580S

(12) **United States Design Patent** (10) **Patent No.:** **US D962,580 S**
Thompson (45) **Date of Patent:** **** *Aug. 30, 2022**

(54) **COLLAPSIBLE GOLF TROLLEY**

(74) *Attorney, Agent, or Firm* — Haugen Law Firm PLLP

(71) Applicant: **Powakaddy International Limited,**
Sittingbourne (GB)

(57) **CLAIM**

The ornamental design for a collapsible golf trolley, as shown and described.

(72) Inventor: **Andrew Thompson,** Sittingbourne
(GB)

DESCRIPTION

(73) Assignee: **Powakaddy International Limited,**
Sittingbourne (GB)

FIG. 1 is a front upper right perspective view of the collapsible golf trolley of the present invention in an open condition;

(*) Notice: This patent is subject to a terminal disclaimer.

FIG. 2 is a front upper left perspective view of the collapsible golf trolley of the present invention in an open condition;

(**) Term: **15 Years**

FIG. 3 is a rear upper right perspective view of the collapsible golf trolley of the present invention in an open condition;

(21) Appl. No.: **29/732,190**

FIG. 4 is a rear upper left perspective view of the collapsible golf trolley of the present invention in an open condition;

(22) Filed: **Apr. 22, 2020**

FIG. 5 is a front elevational view of the collapsible golf trolley of the present invention in an open condition;

(51) **LOC (13) Cl.** **12-02**

(52) **U.S. Cl.**
USPC **D34/15**

FIG. 6 is a rear elevational view of the collapsible golf trolley of the present invention in an open condition;

(58) **Field of Classification Search**
USPC **D34/12-27**

FIG. 7 is a right side elevational view of the collapsible golf trolley of the present invention in an open condition;

(Continued)

FIG. 8 is a left side elevational view of the collapsible golf trolley of the present invention in an open condition;

(56) **References Cited**

U.S. PATENT DOCUMENTS

D638,601 S * 5/2011 Lin D34/15

D664,732 S * 7/2012 Liao D34/15

(Continued)

FIG. 9 is a top plan view of the collapsible golf trolley of the present invention in an open condition;

OTHER PUBLICATIONS

PowaCaddy CT6, announced Aug. 2020 [online], [site visited Feb. 16, 2021]. Available from internet, URL: <https://www.golfcaddieoutlet.com/products/powakaddy-ct6-gps-with-ebs-electric-trolley-free-shipping-accessories> (Year: 2020).*

(Continued)

FIG. 10 is a bottom plan view of the collapsible golf trolley of the present invention in an open condition;

FIG. 11 is a front upper right perspective view of the collapsible golf trolley of the present invention in a folded condition;

FIG. 12 is a front upper left perspective view of the collapsible golf trolley of the present invention in a folded condition;

FIG. 13 is a rear upper right perspective view of the collapsible golf trolley of the present invention in a folded condition;

FIG. 14 is a rear upper left perspective view of the collapsible golf trolley of the present invention in a folded condition;

(Continued)

Primary Examiner — Cynthia Ramirez

Assistant Examiner — Tamara L Hahn

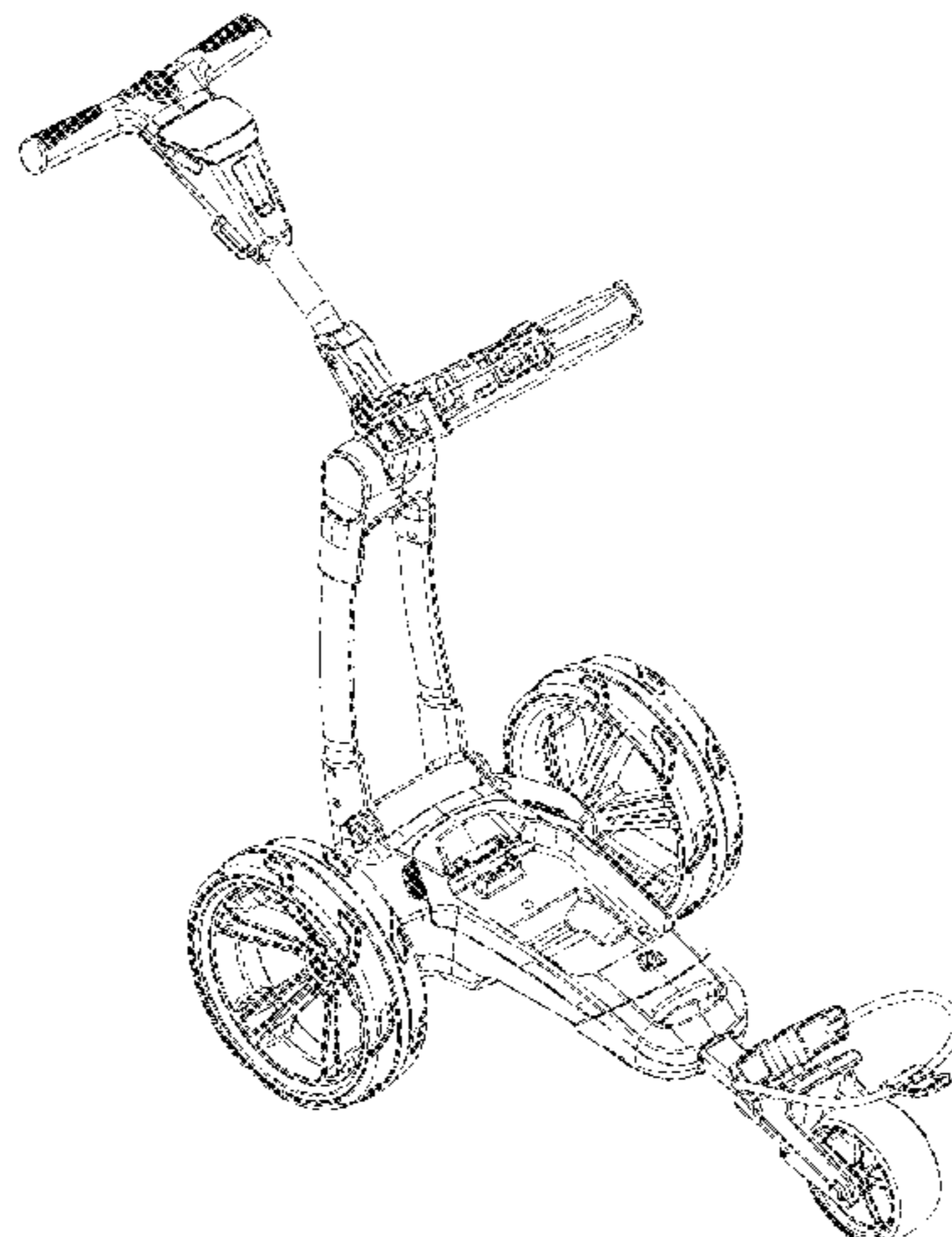

FIG. 15 is a front elevational view of the collapsible golf trolley of the present invention in a folded condition;
 FIG. 16 is a rear elevational view of the collapsible golf trolley of the present invention in a folded condition;
 FIG. 17 is a right side elevational view of the collapsible golf trolley of the present invention in a folded condition;
 FIG. 18 is a left side elevational view of the collapsible golf trolley of the present invention in a folded condition;
 FIG. 19 is a top plan view of the collapsible golf trolley of the present invention in a folded condition; and,
 FIG. 20 is a bottom plan view of the collapsible golf trolley of the present invention in a folded condition.

1 Claim, 20 Drawing Sheets

(58) Field of Classification Search

CPC .. B62B 3/02; B62B 3/12; B62B 7/068; B62B
 2202/404

See application file for complete search history.

(56) References Cited

U.S. PATENT DOCUMENTS

D703,411 S * 4/2014 Lin D34/15
 D786,523 S * 5/2017 Mitchell D34/15

D794,896 S * 8/2017 Liao D34/15
 D812,333 S * 3/2018 Gong D34/15
 D870,408 S * 12/2019 Thompson D34/15
 2009/0295130 A1* 12/2009 Liao B62B 3/12
 280/651
 2011/0175331 A1* 7/2011 Zhang B62B 3/12
 280/651
 2011/0181027 A1* 7/2011 Zhang B62B 3/02
 280/651
 2011/0285111 A1* 11/2011 Liao B62B 3/02
 280/651
 2012/0025481 A1* 2/2012 Wu B62B 3/02
 280/38
 2012/0261908 A1* 10/2012 Liao B62B 3/02
 280/651
 2014/0333049 A1* 11/2014 Wu A63B 55/60
 280/651

OTHER PUBLICATIONS

PowaCaddy FX5, announced Aug. 2020 [online], [site visited Feb. 16, 2021]. Available from internet, URL: <https://www.golfcaddieoutlet.com/products/powakaddy-fx5-electric-trolley-free-shipping-accessories?variant=31941289967679> (Year: 2020).*

* cited by examiner

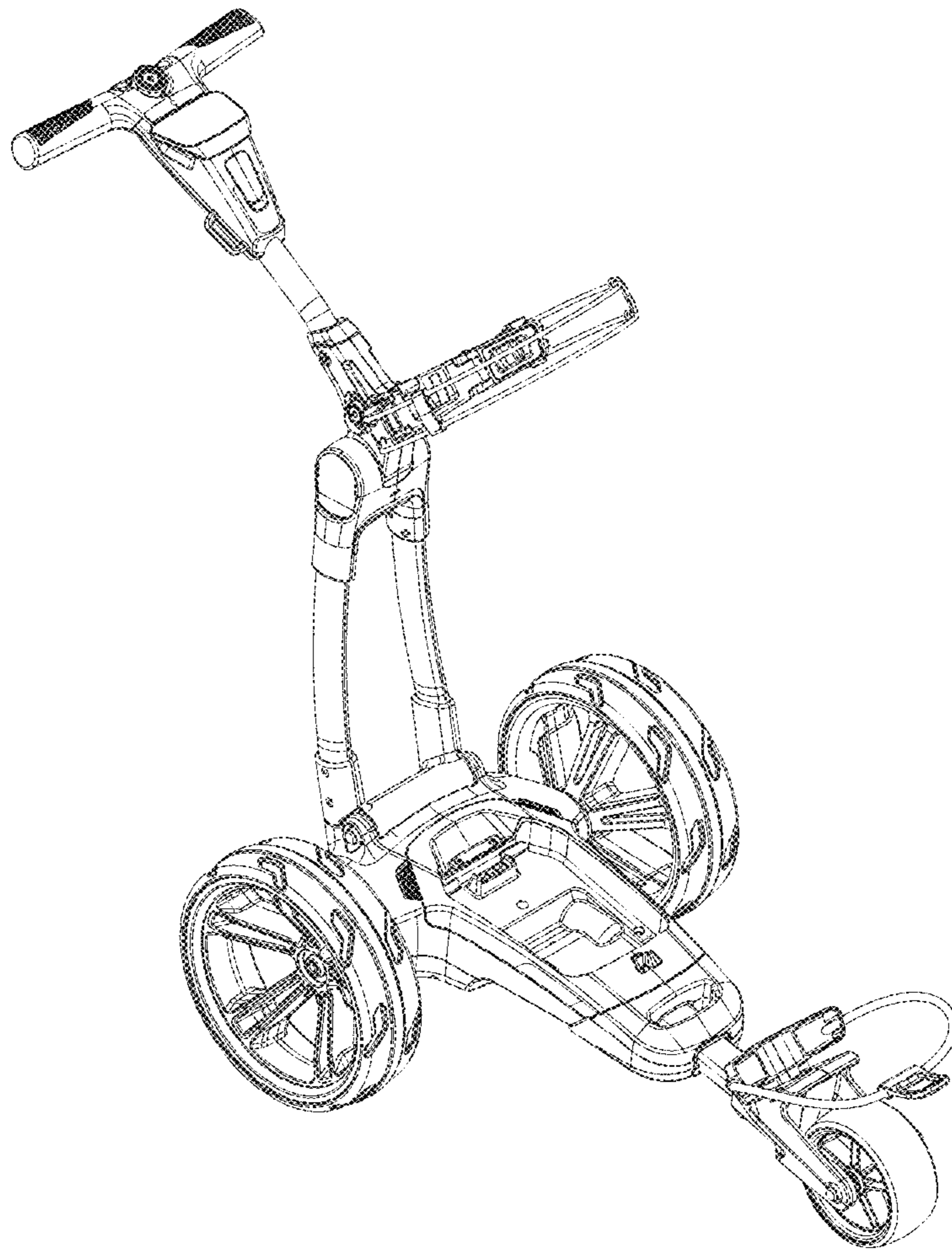

FIG. 1

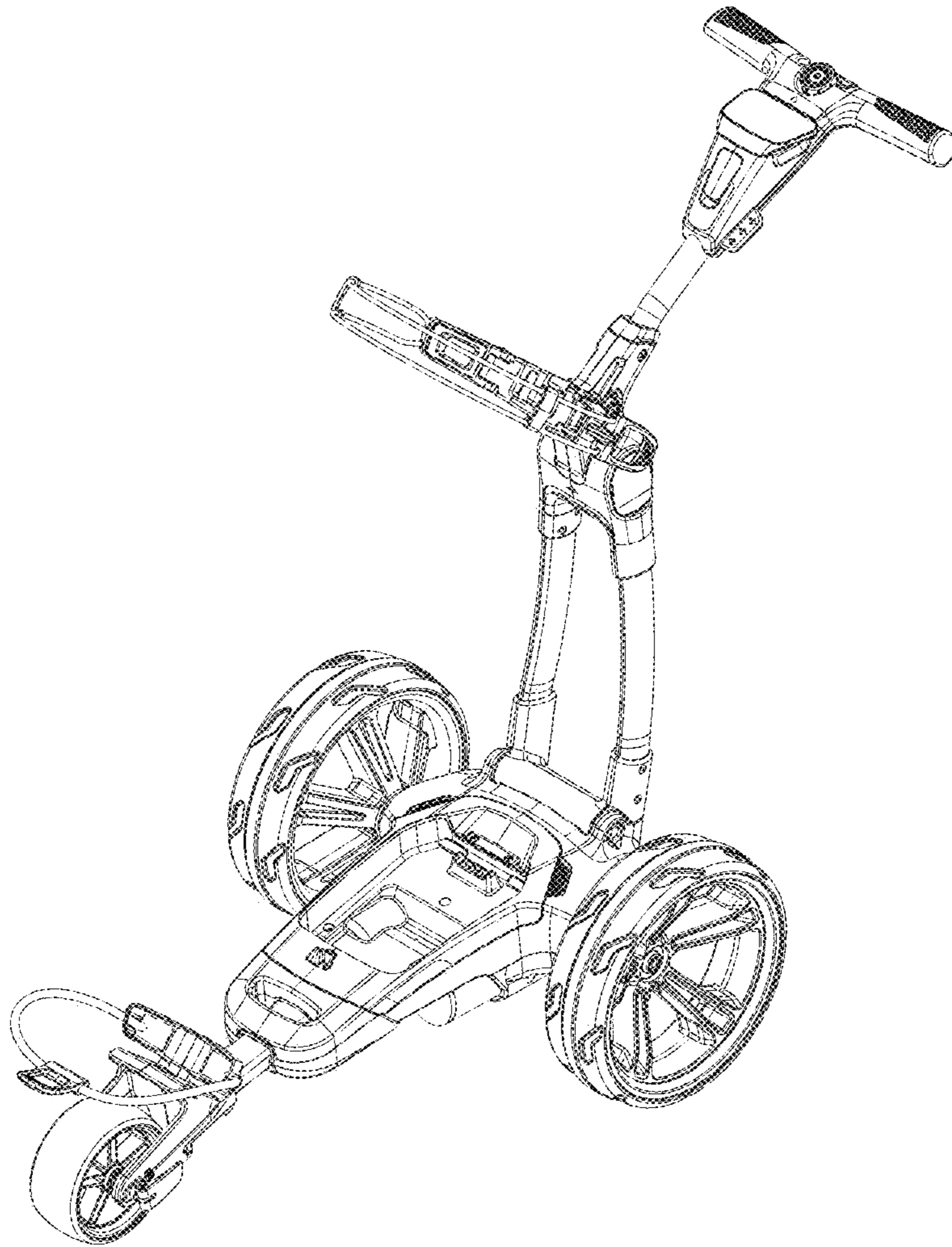

FIG. 2

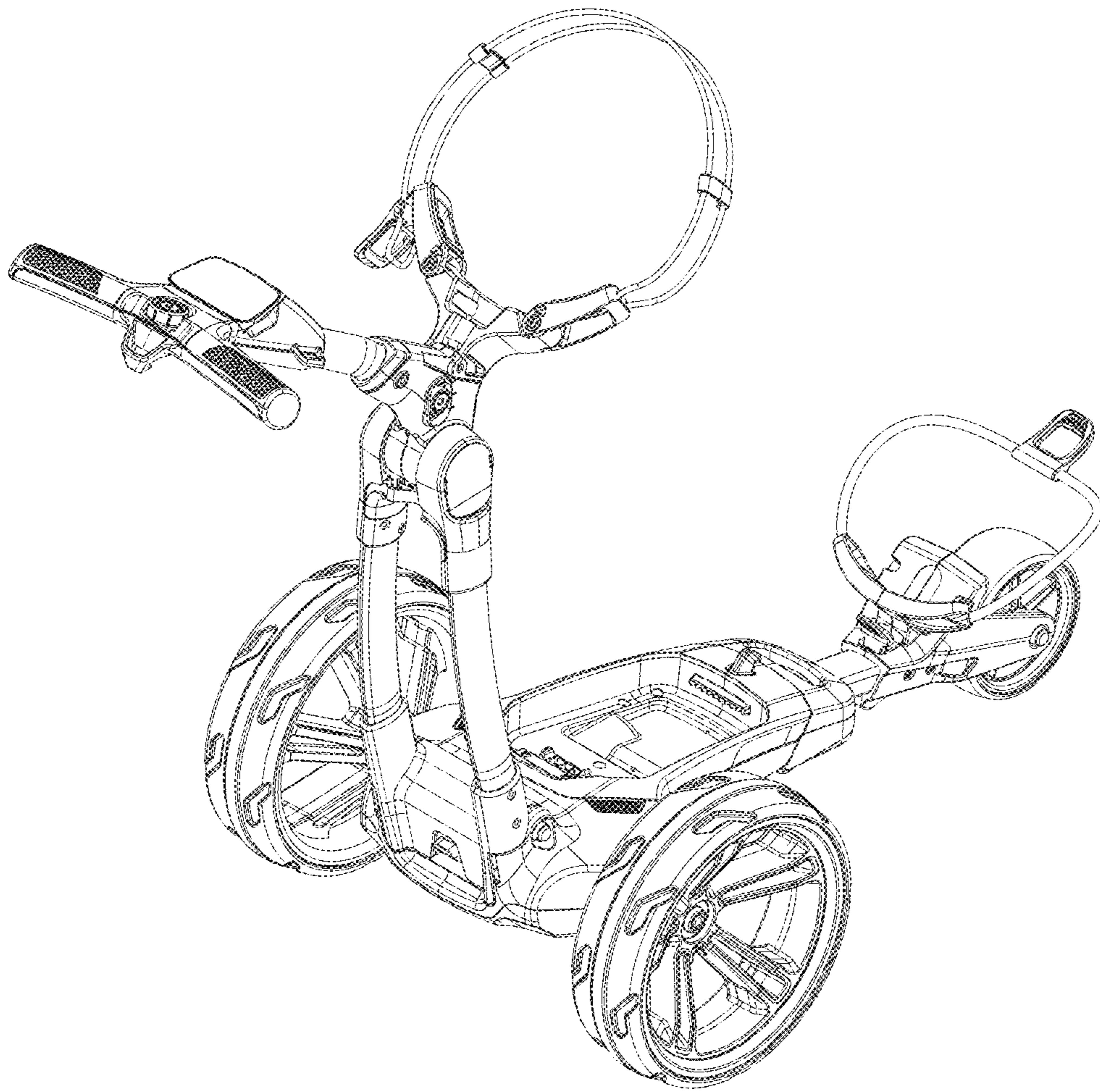

FIG. 3

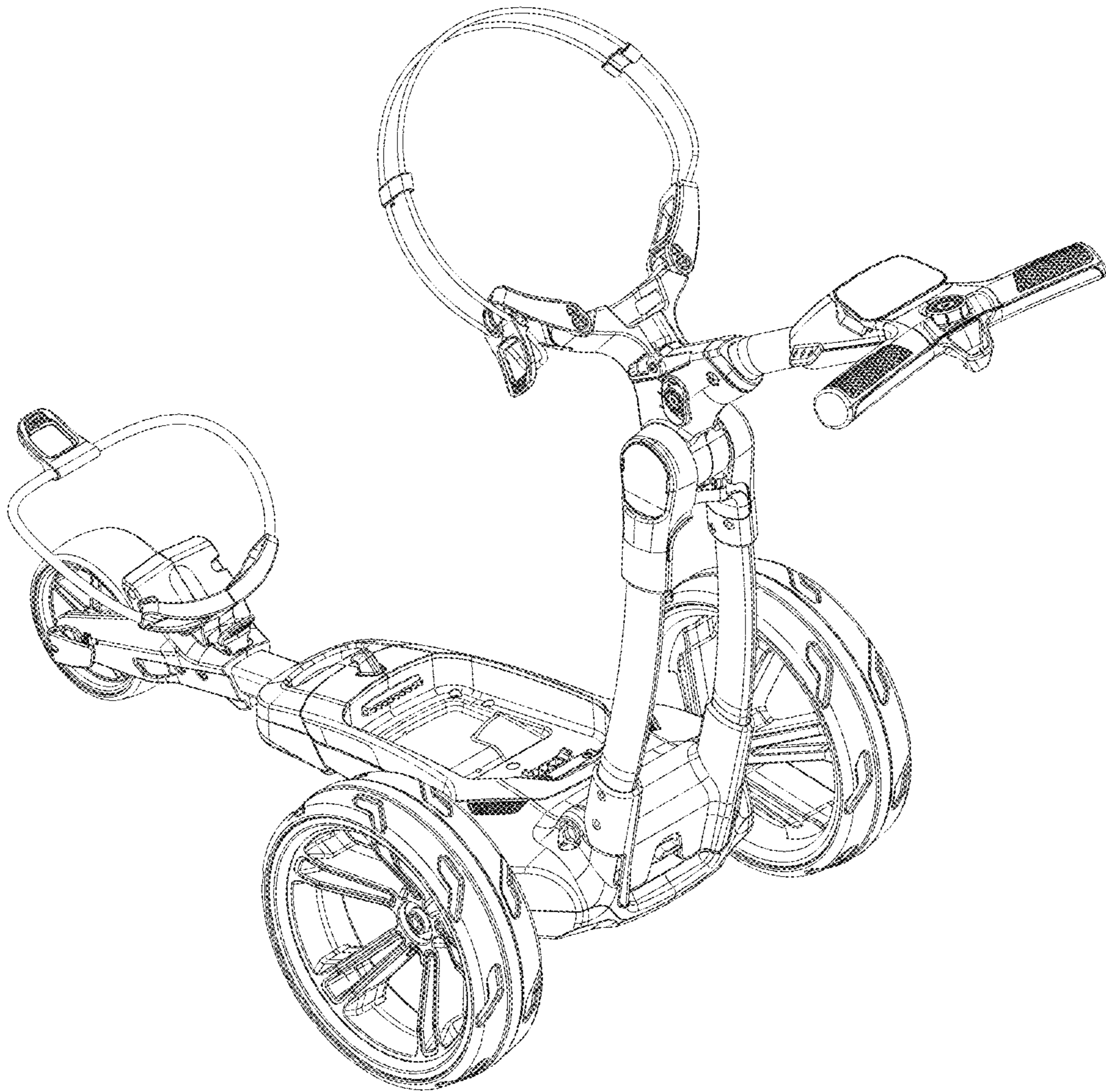

FIG. 4

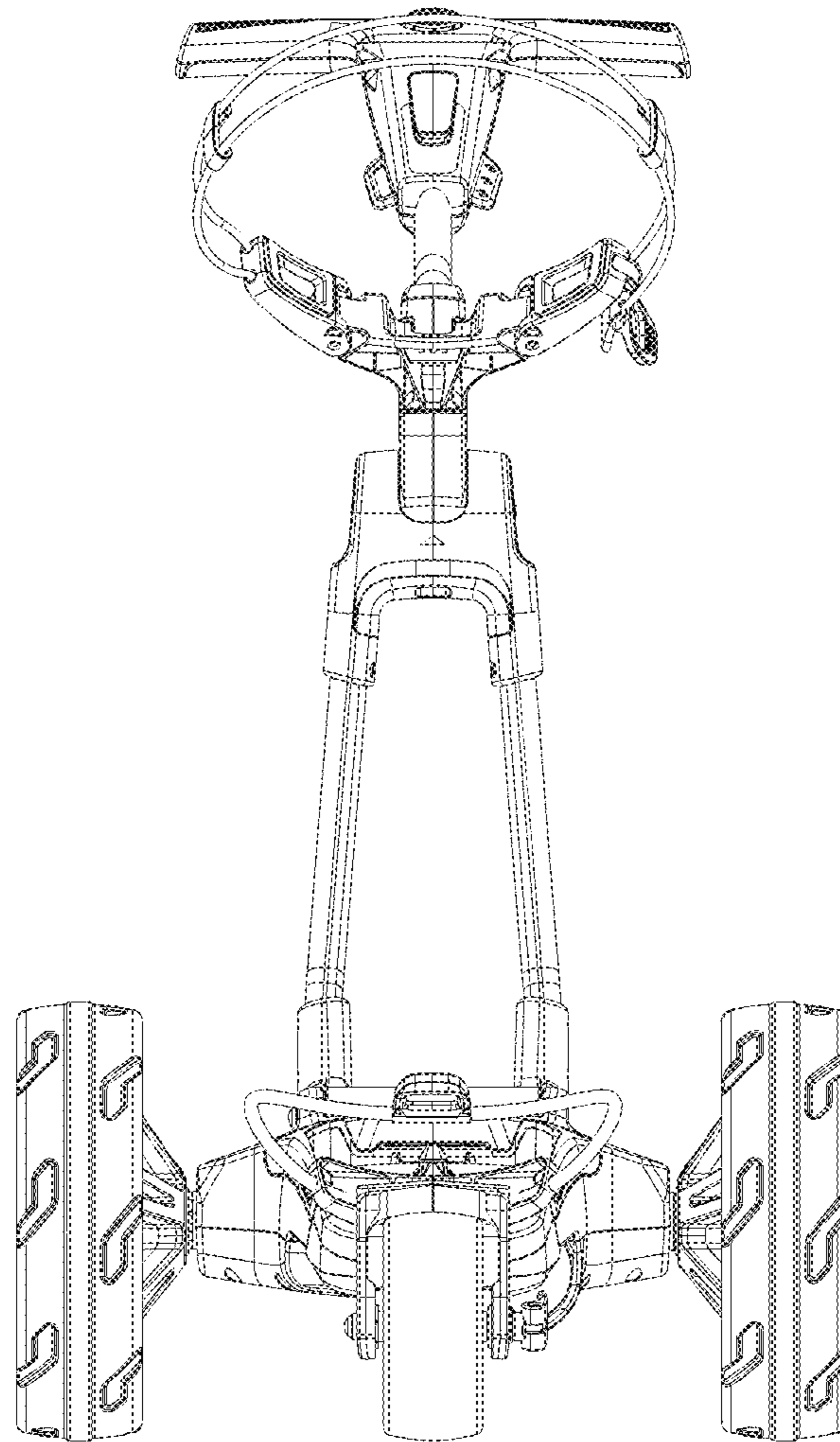

FIG. 5

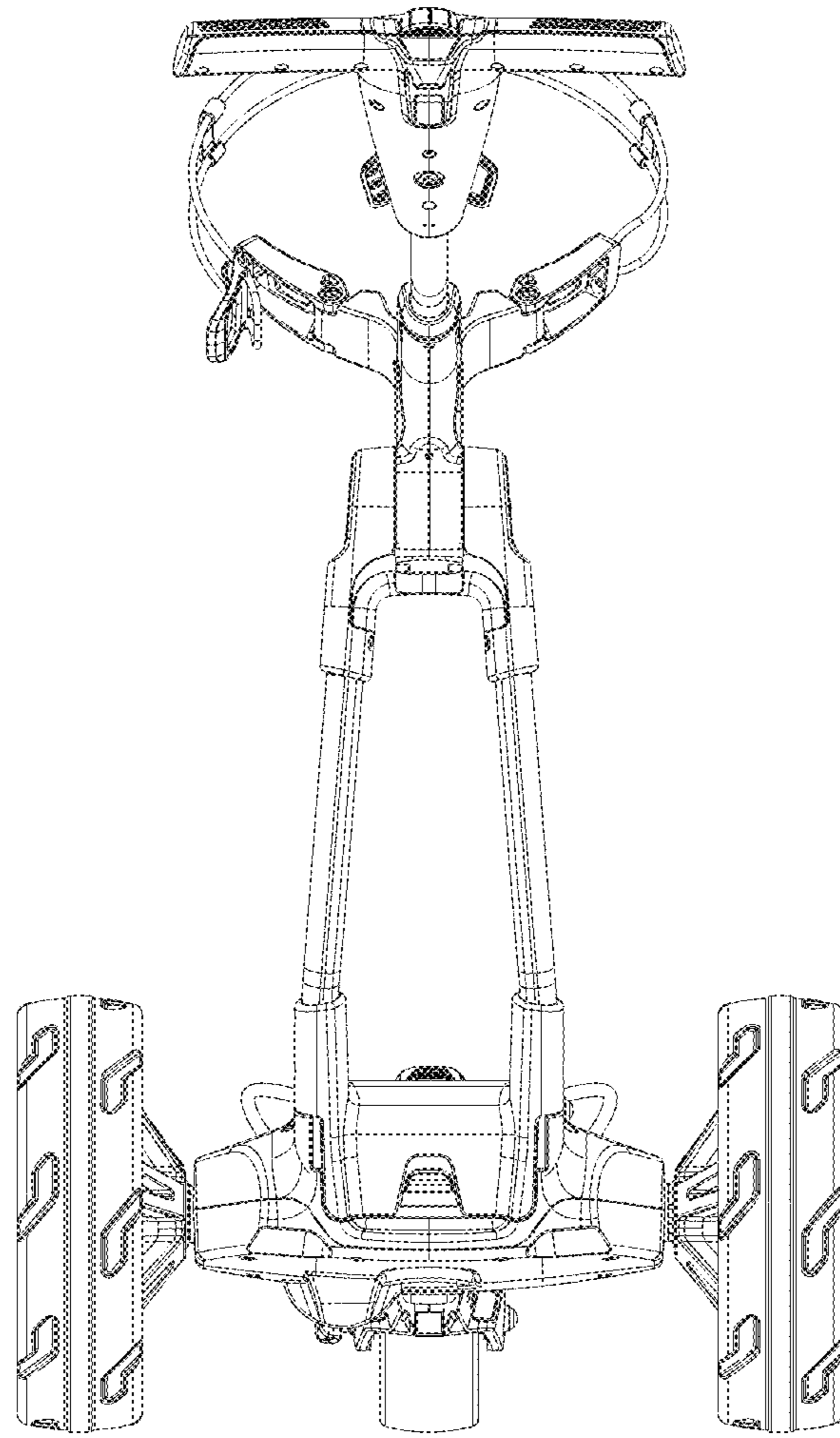

FIG. 6

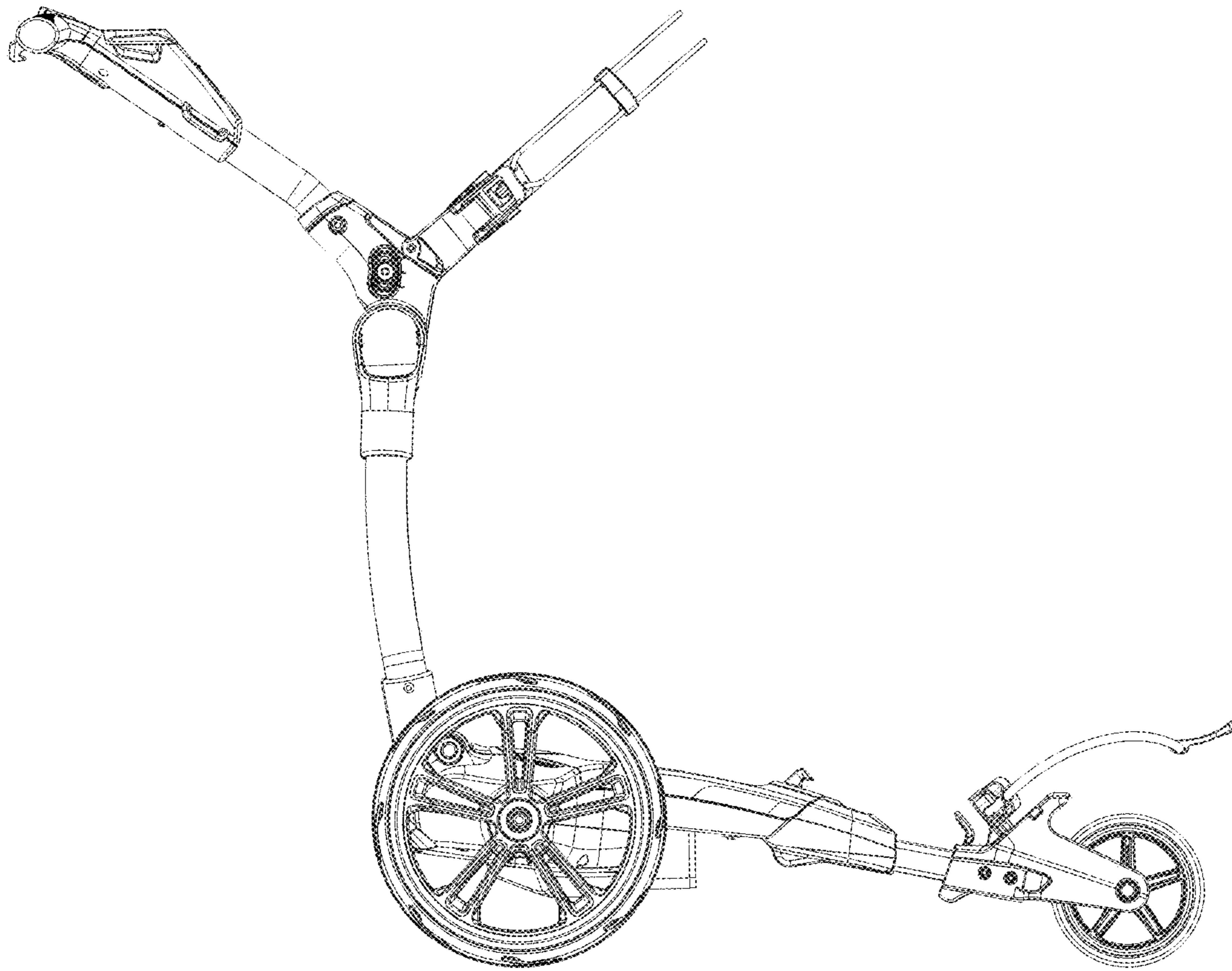

FIG. 7

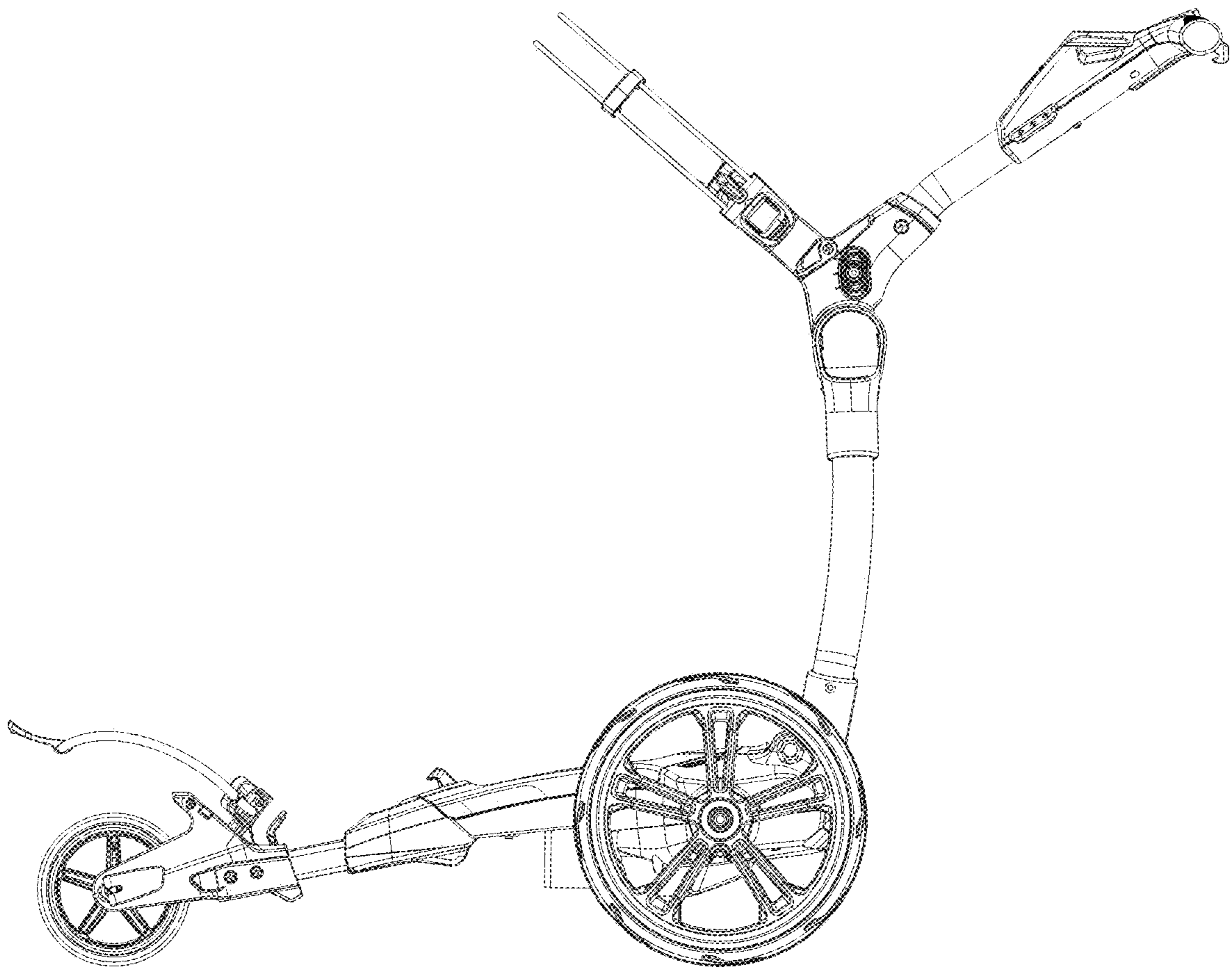

FIG. 8

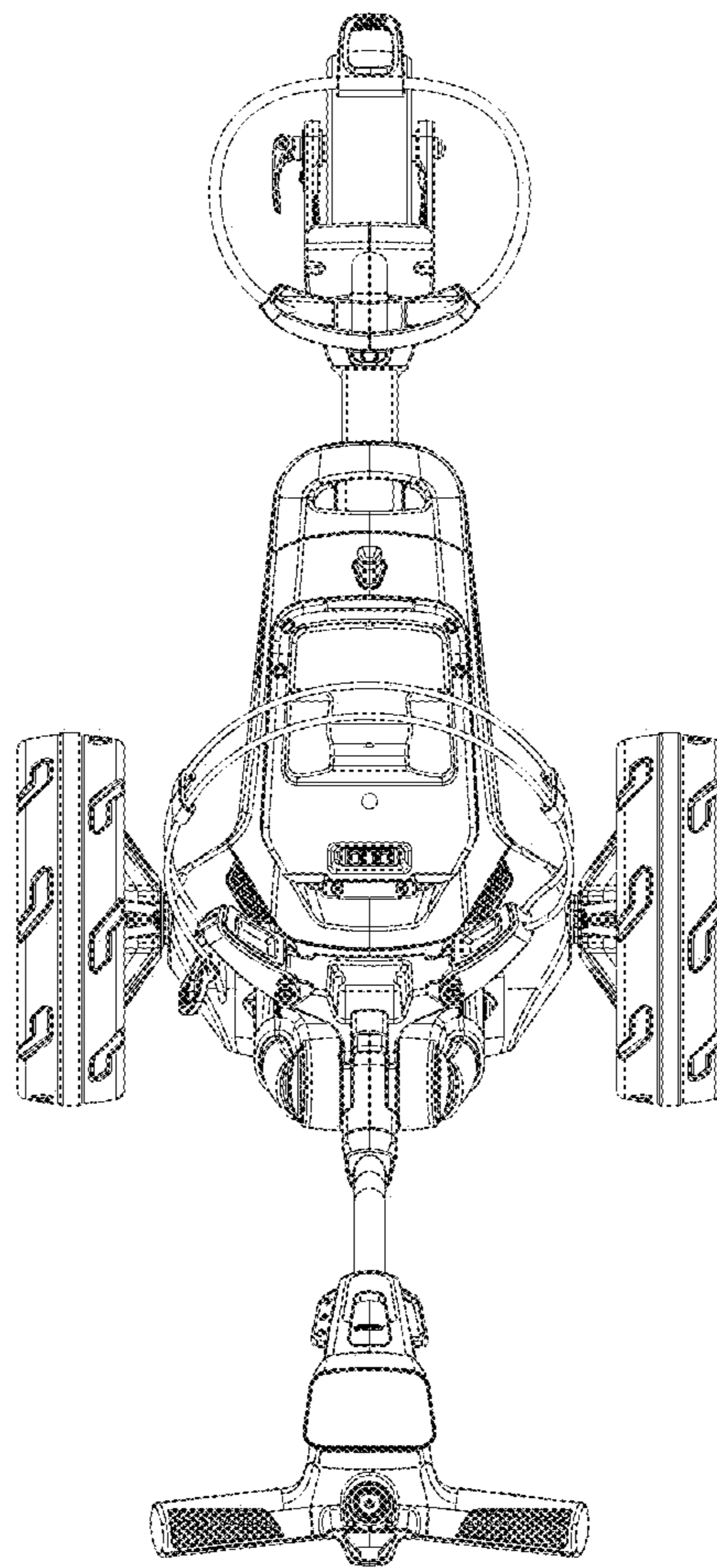

FIG. 9

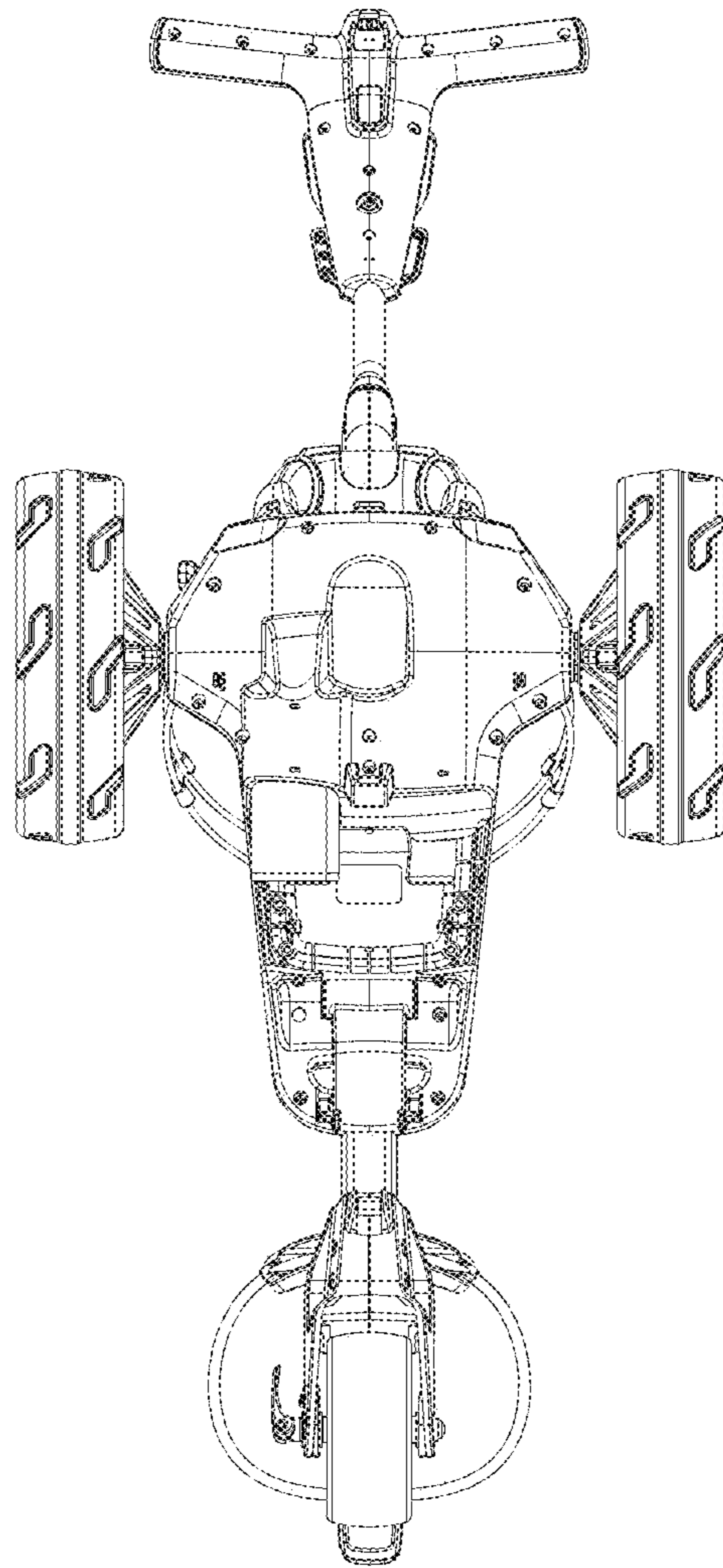

FIG. 10

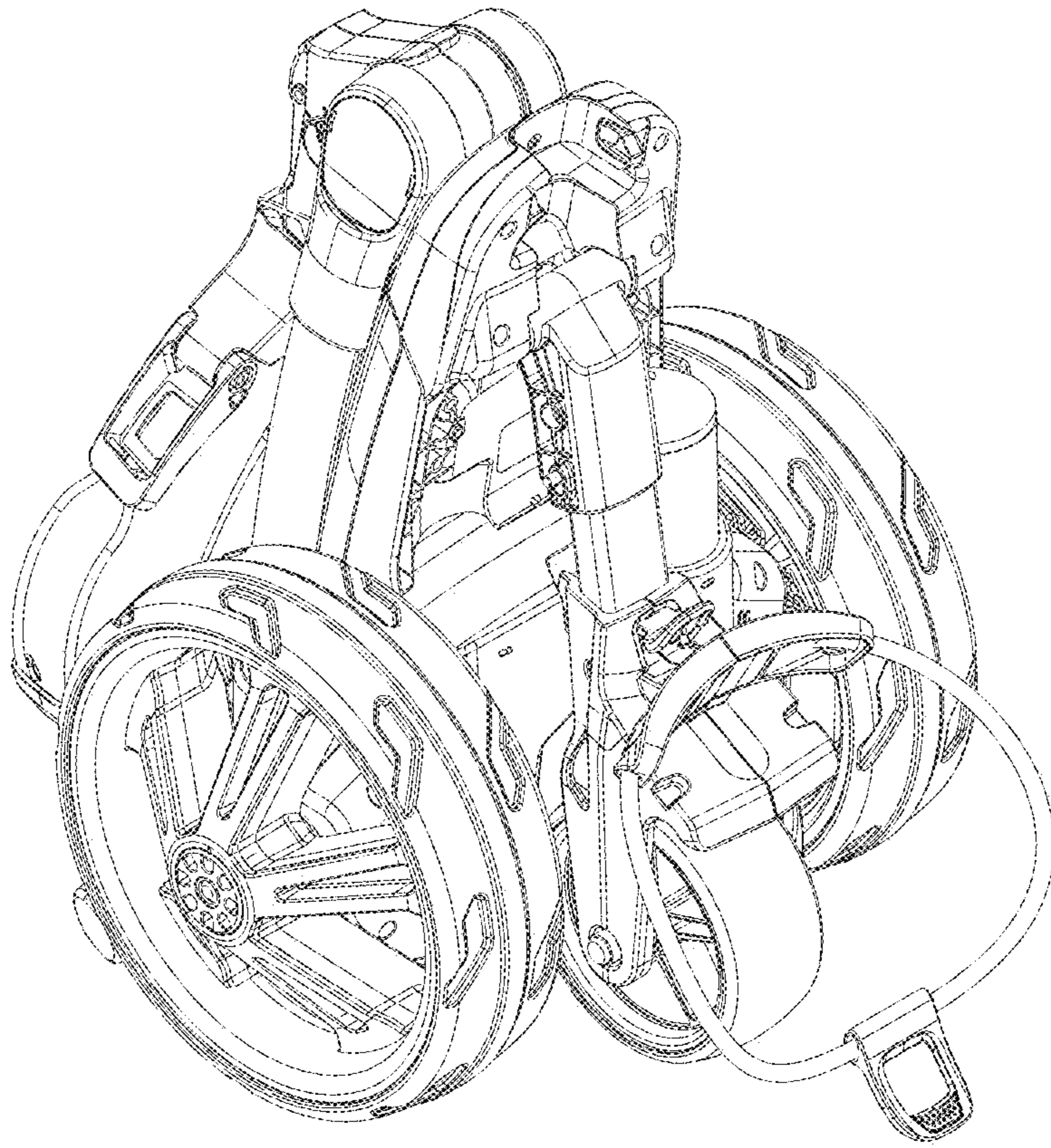

FIG. 11

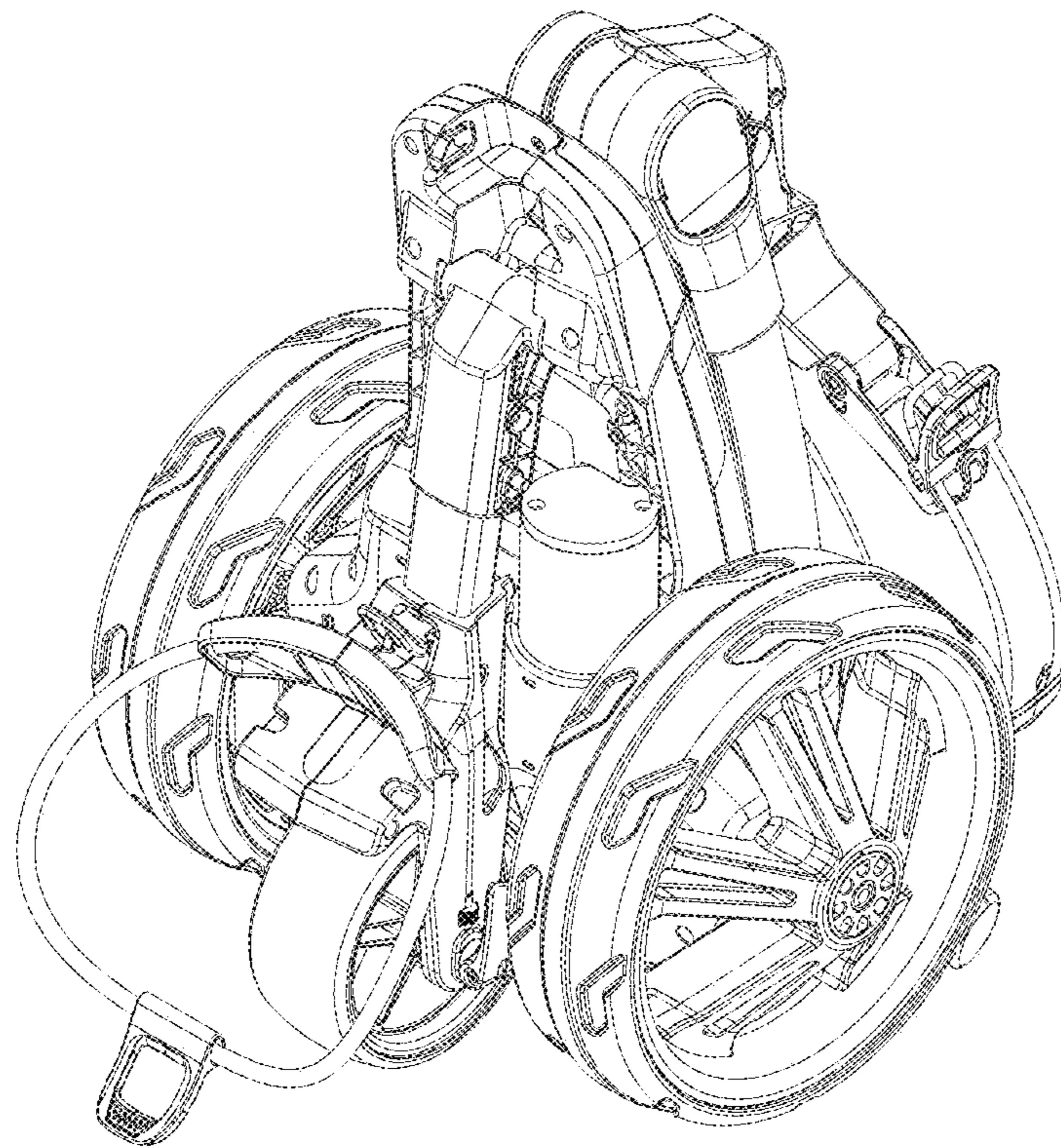

FIG. 12

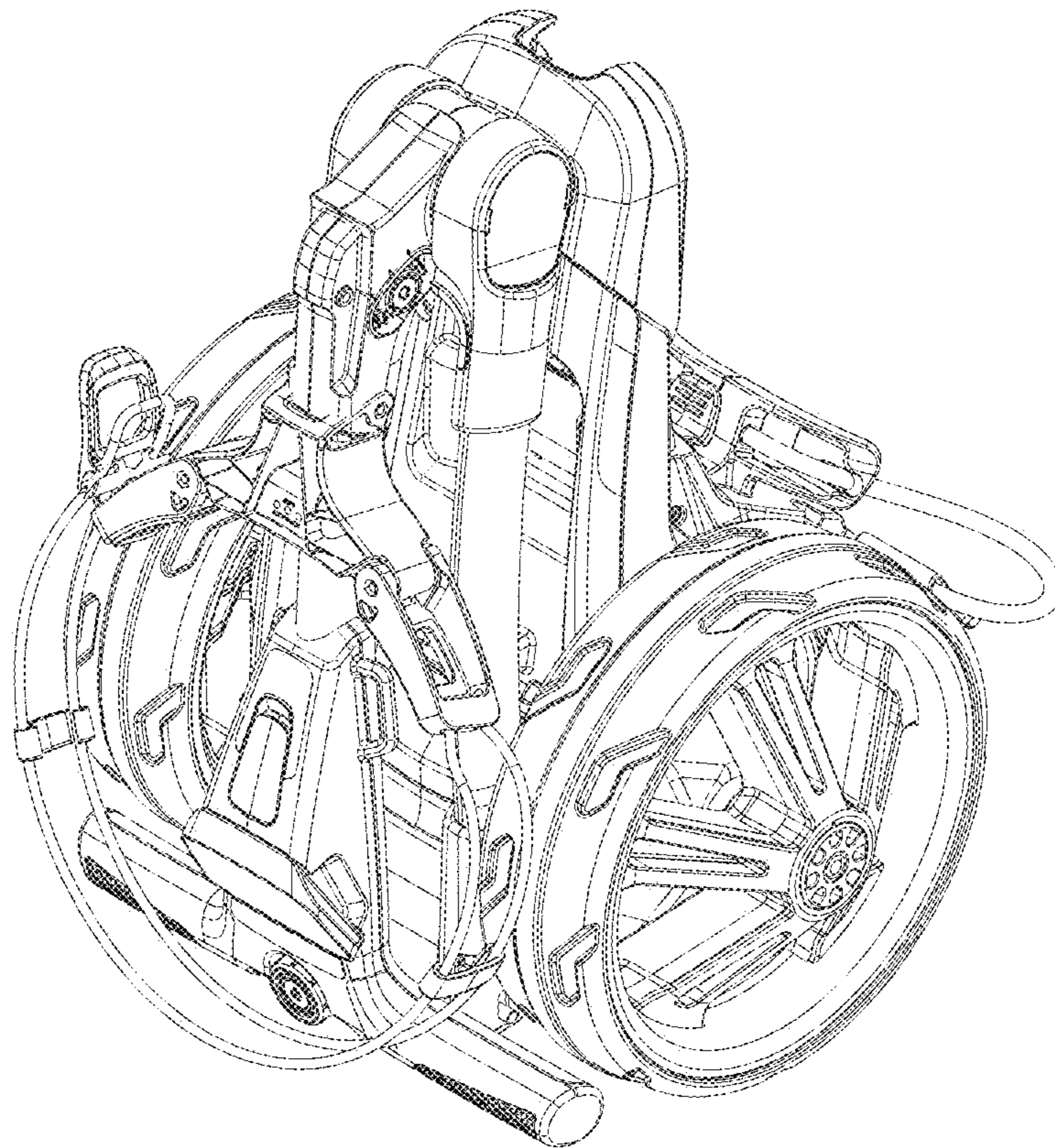

FIG. 13

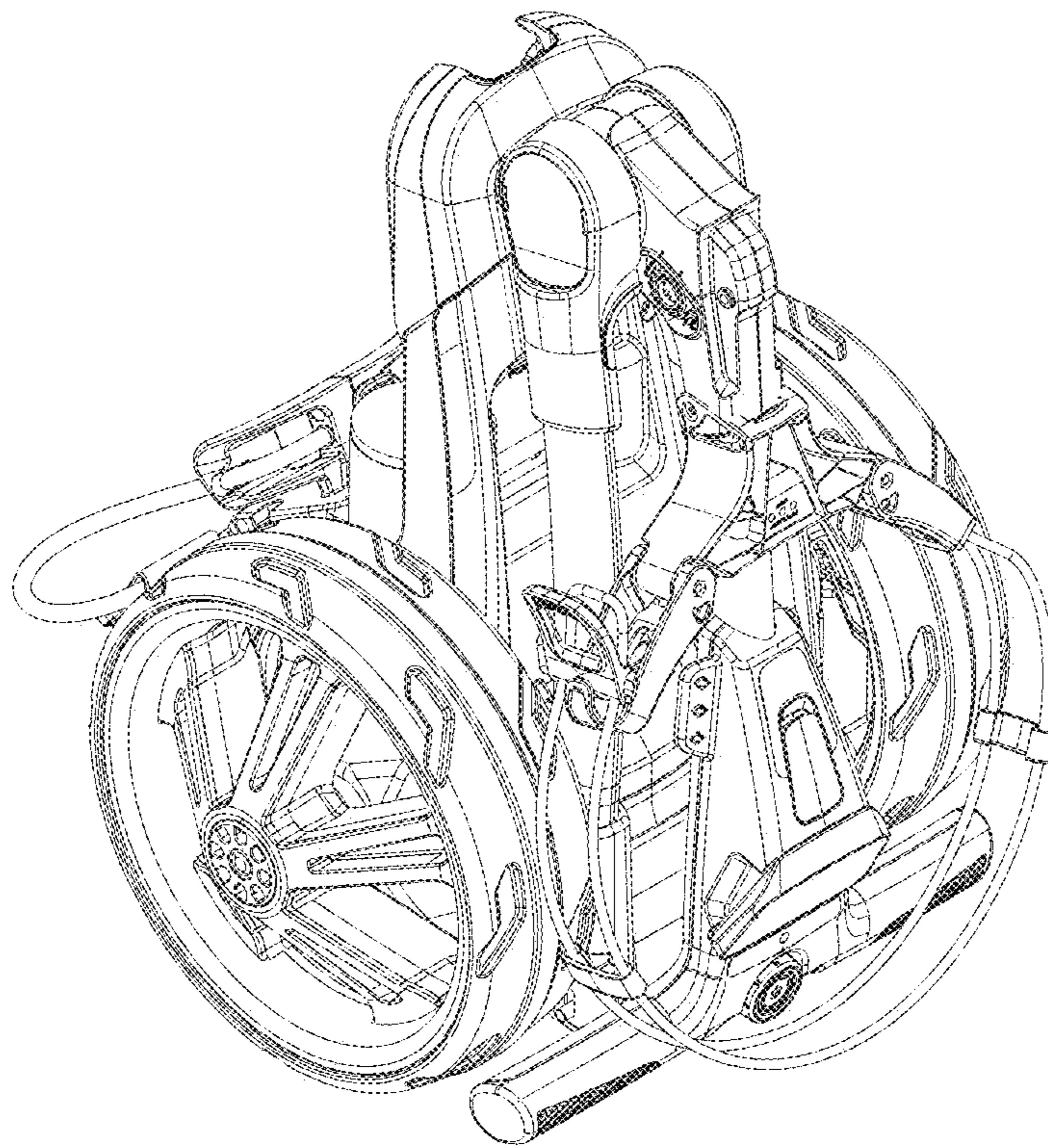

FIG. 14

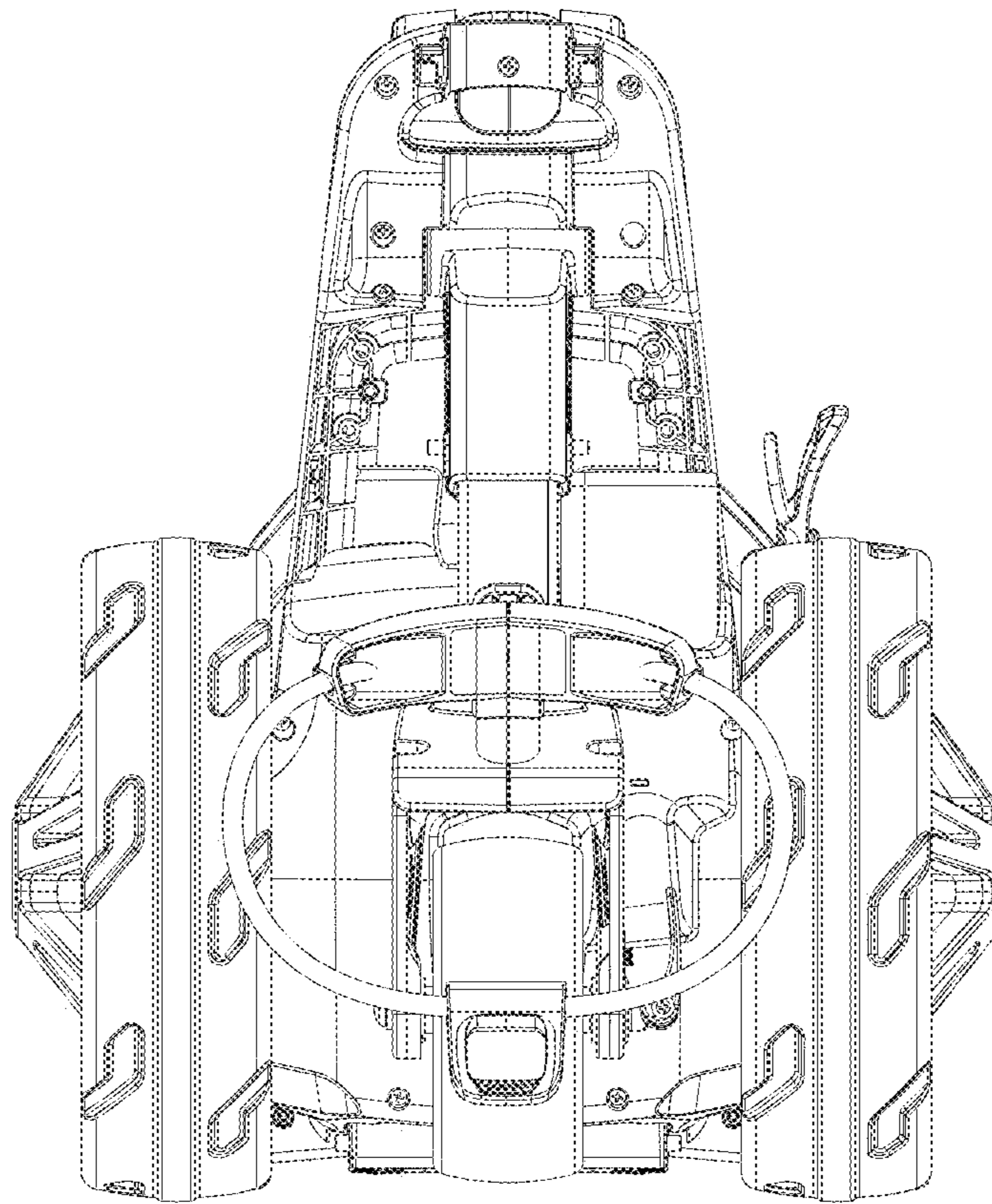

FIG. 15

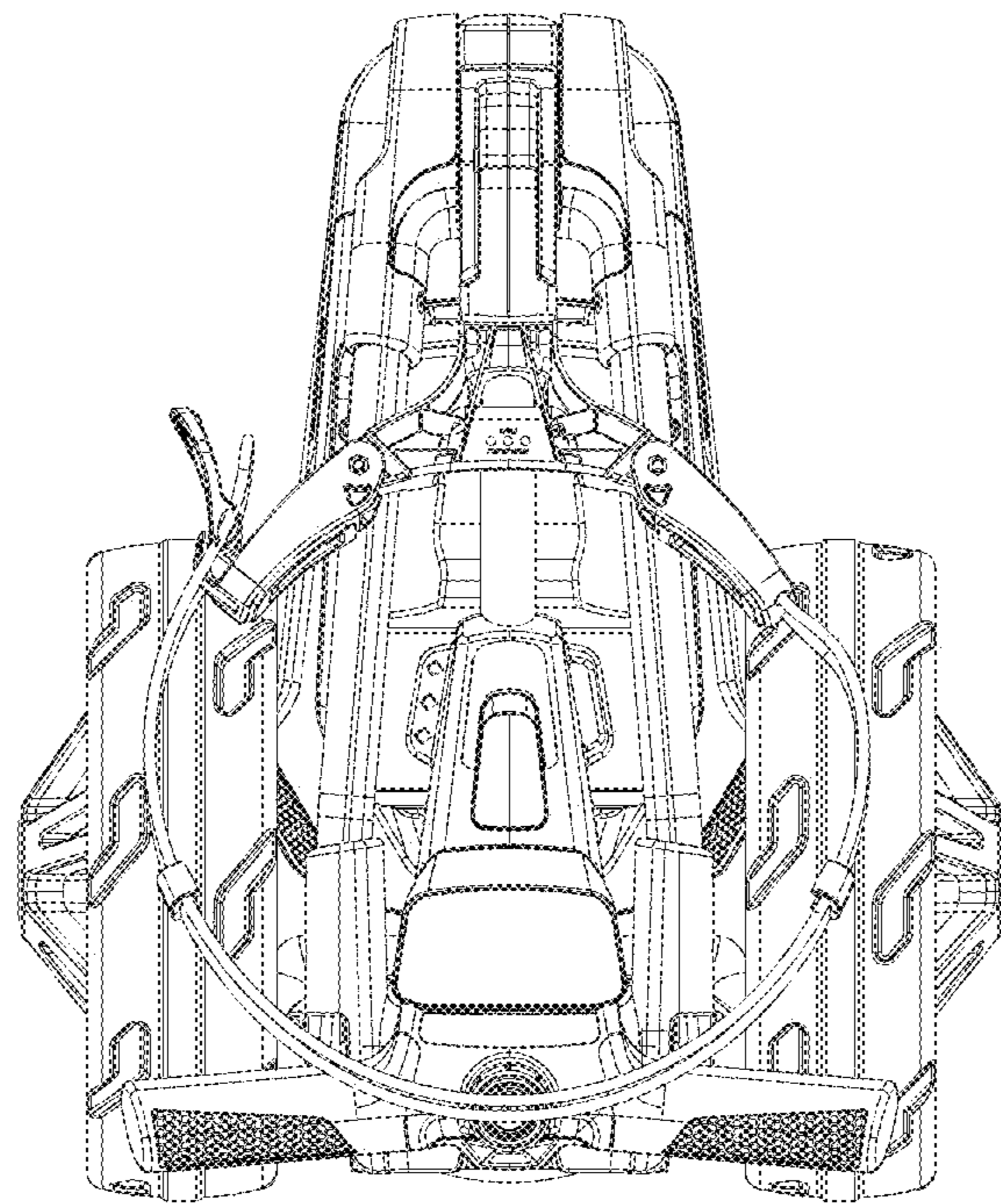

FIG. 16

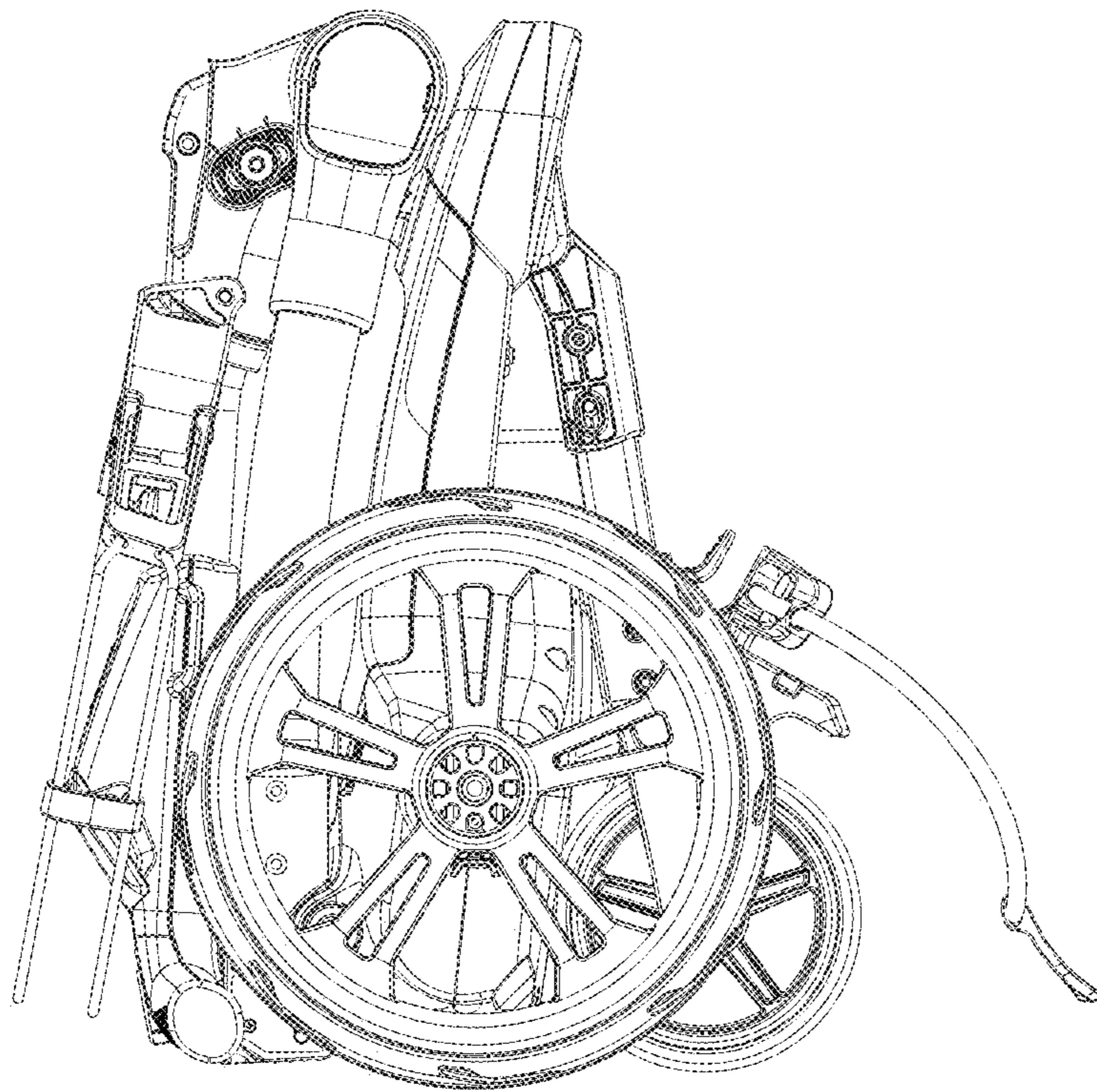

FIG. 17

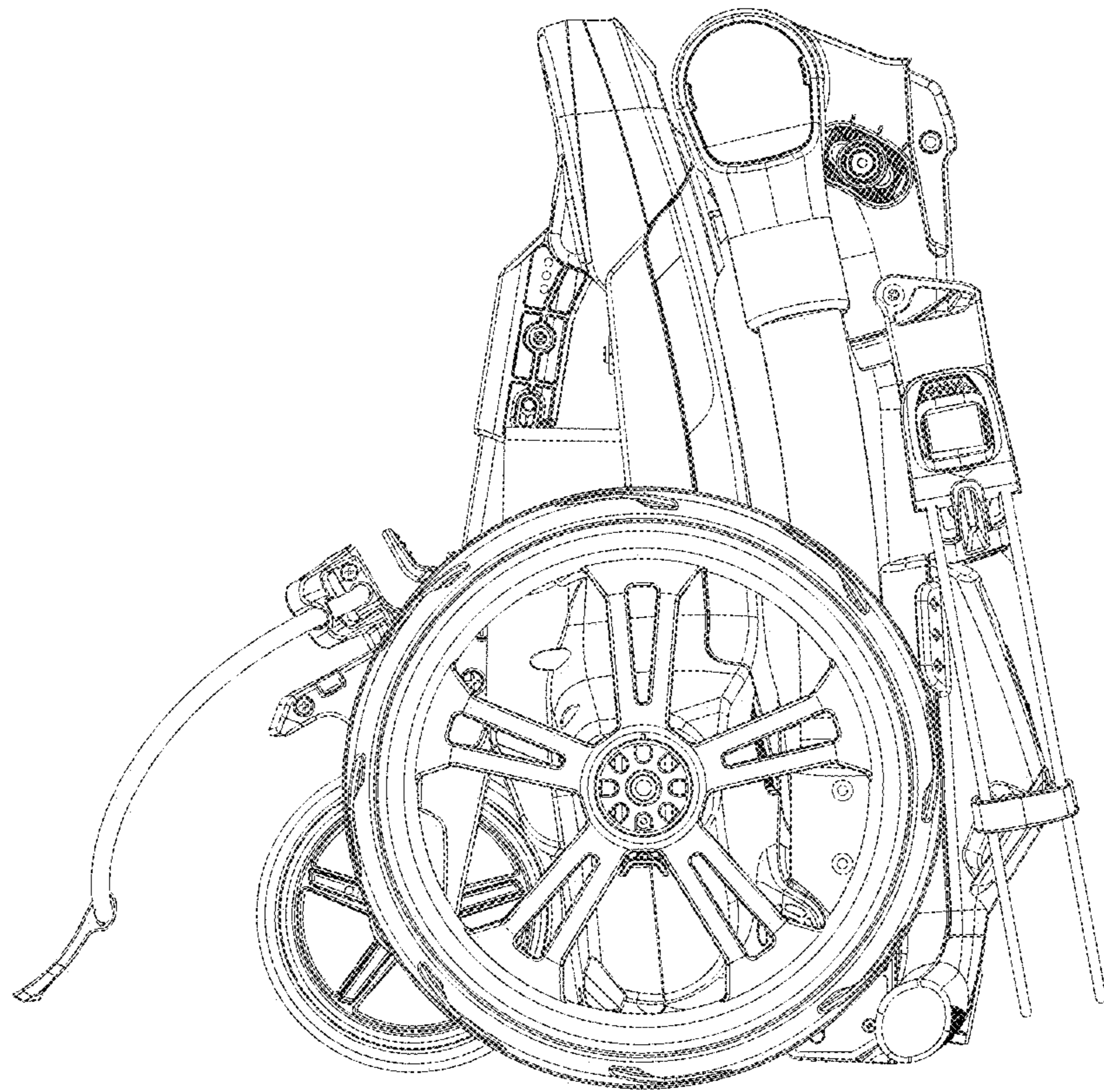

FIG. 18

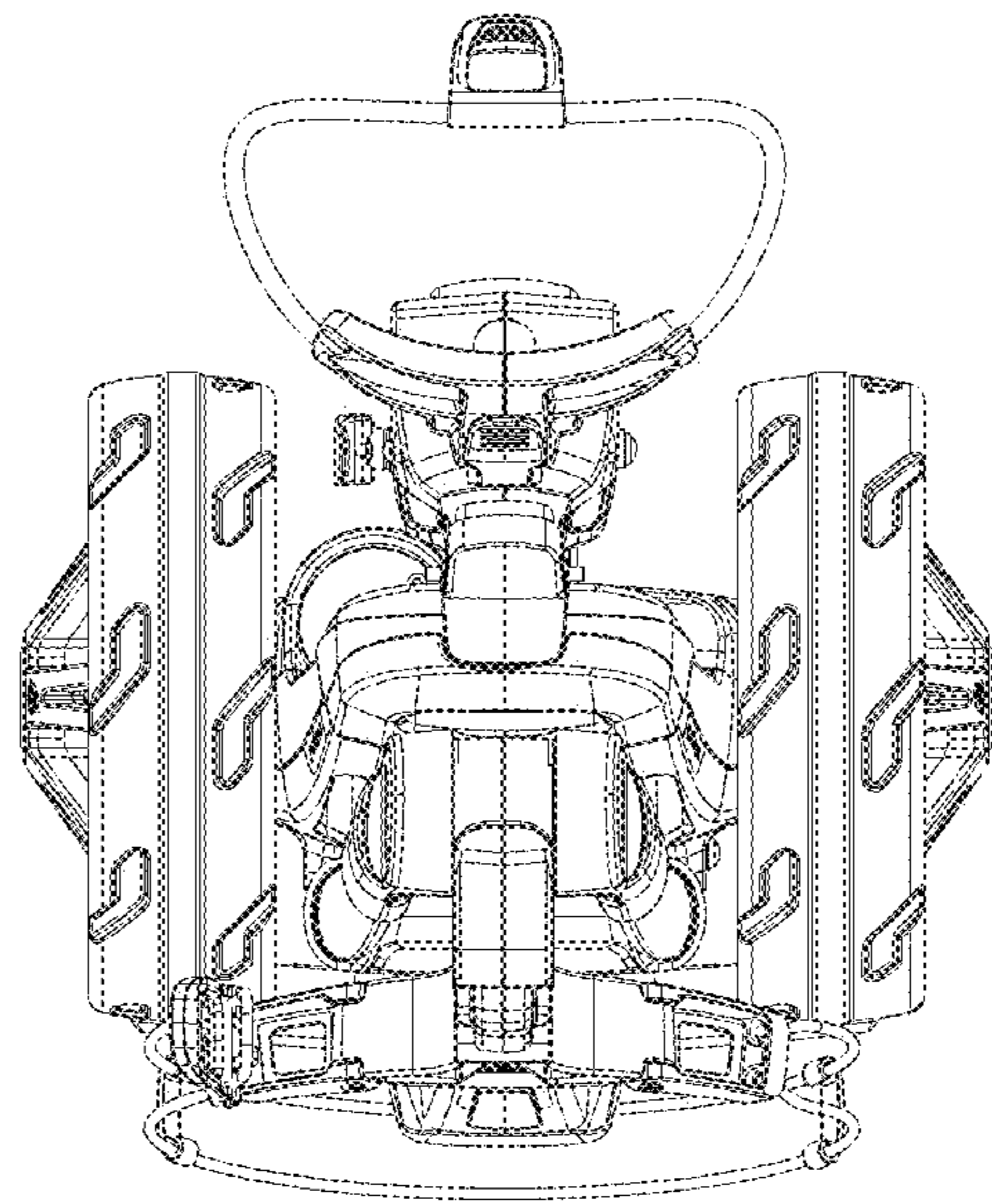

FIG. 19

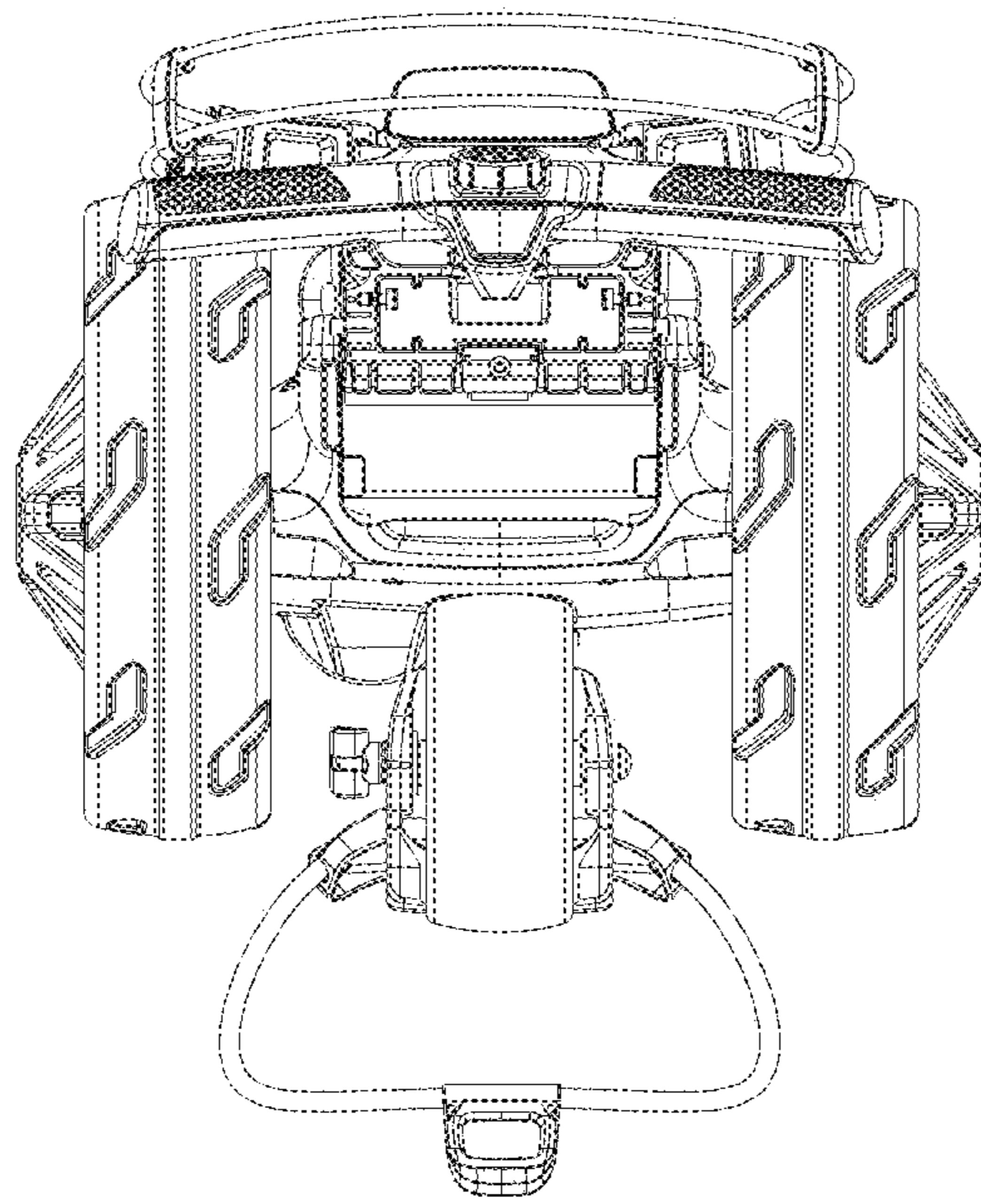

FIG. 20