

US00D962509S

(12) **United States Design Patent** (10) **Patent No.:** **US D962,509 S**
He (45) **Date of Patent:** **** Aug. 30, 2022**

(54) **VEHICLE HEADLIGHT**

(71) Applicant: **Arex Industries, Inc.**, Irwindale, CA
(US)

(72) Inventor: **Mizeng He**, TaiZhou (CN)

(**) Term: **15 Years**

(21) Appl. No.: **29/769,345**

(22) Filed: **Feb. 4, 2021**

(51) **LOC (13) Cl.** **26-06**

(52) **U.S. Cl.**
USPC **D26/28**

(58) **Field of Classification Search**
USPC D26/28-36, 139
CPC F21S 48/00; F21S 48/10; F21S 48/115;
F21S 48/225; F21S 48/1233; F21S
48/1266; F21S 48/1388; F21S 48/2268;
F21V 5/00; F21V 21/04; F21V 29/004;
B60Q 9/13; B60Q 9/135; B60Q 9/1375;
F21W 2102/17; F21W 2103/00; F21W
2103/35; F21W 2103/55; F21W 2107/13;
F21W 2107/17

See application file for complete search history.

(56) **References Cited**

U.S. PATENT DOCUMENTS

D783,189 S * 4/2017 Nishii D26/28
D787,726 S * 5/2017 Hong D26/28

D788,956 S * 6/2017 Hong D26/28
D792,622 S * 7/2017 Briscoe D26/28
D794,851 S * 8/2017 Youn D26/28
D794,853 S * 8/2017 Lai D26/28
D835,308 S * 12/2018 Metros D26/28

* cited by examiner

Primary Examiner — Marcus A Jackson

(74) *Attorney, Agent, or Firm* — Theodore S. Lee, Esq.

(57) **CLAIM**

the ornamental design for a vehicle headlight, as shown and described.

DESCRIPTION

FIG. 1 is a perspective view of a vehicle headlight according to the novel design;
FIG. 2 is left side view thereof;
FIG. 3 is a front view thereof;
FIG. 4 is a right side view thereof;
FIG. 5 is an alternative perspective view thereof; and,
FIG. 6 is a top view thereof.
The drawings and descriptions represent the right side embodiment. The claim is also for a mirror image of a left side embodiment that is not shown.

1 Claim, 6 Drawing Sheets

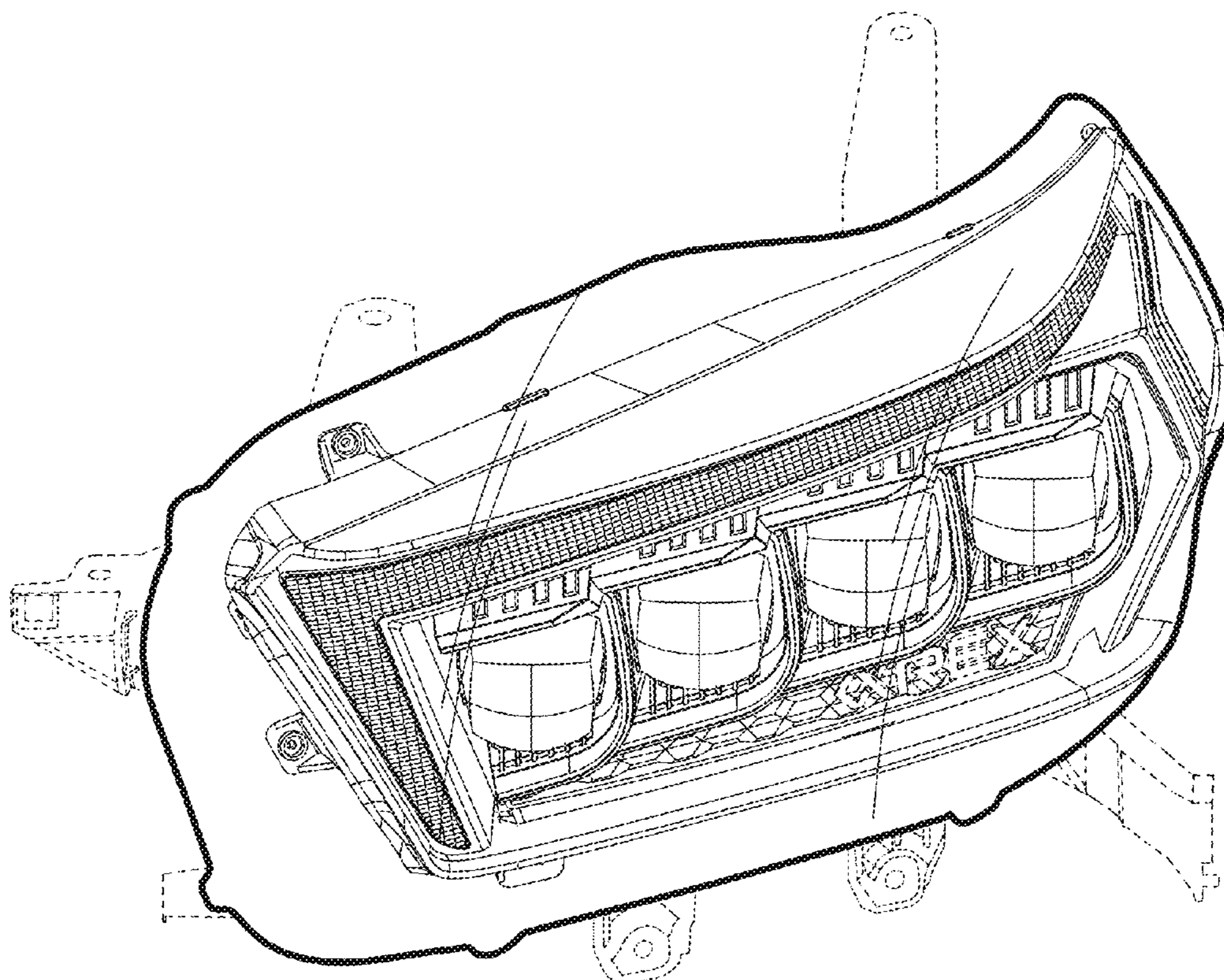

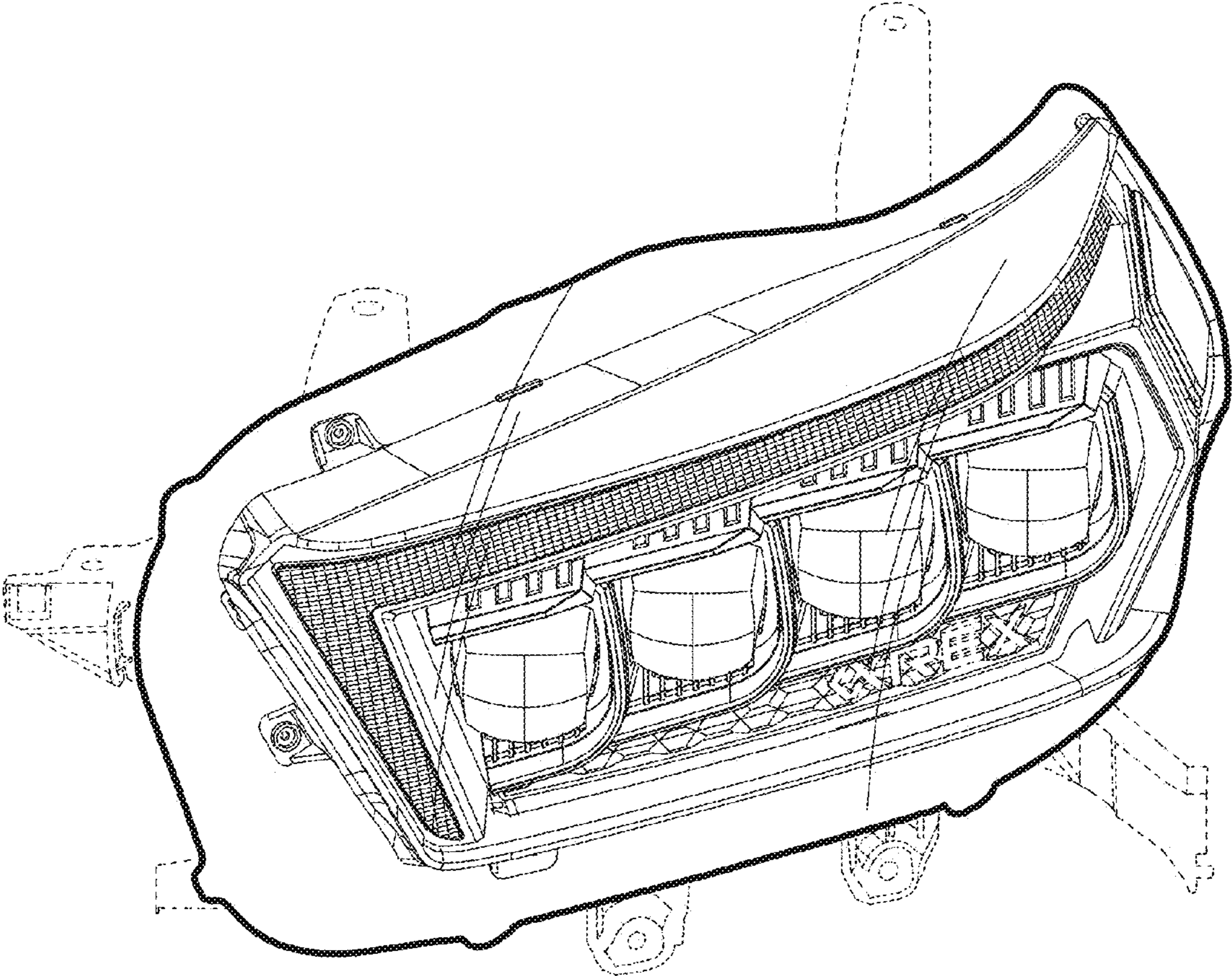

FIG. 1

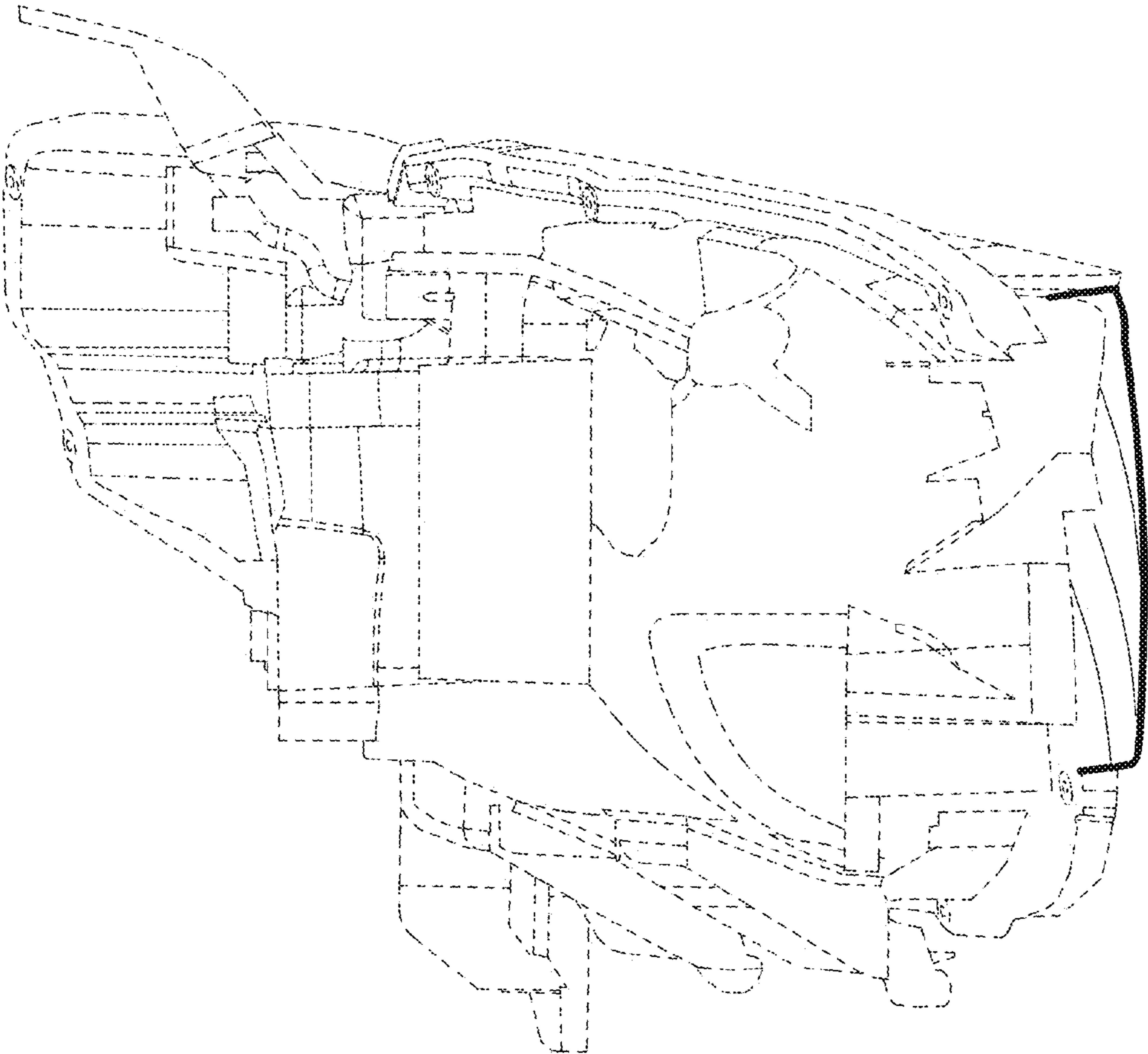

FIG. 2

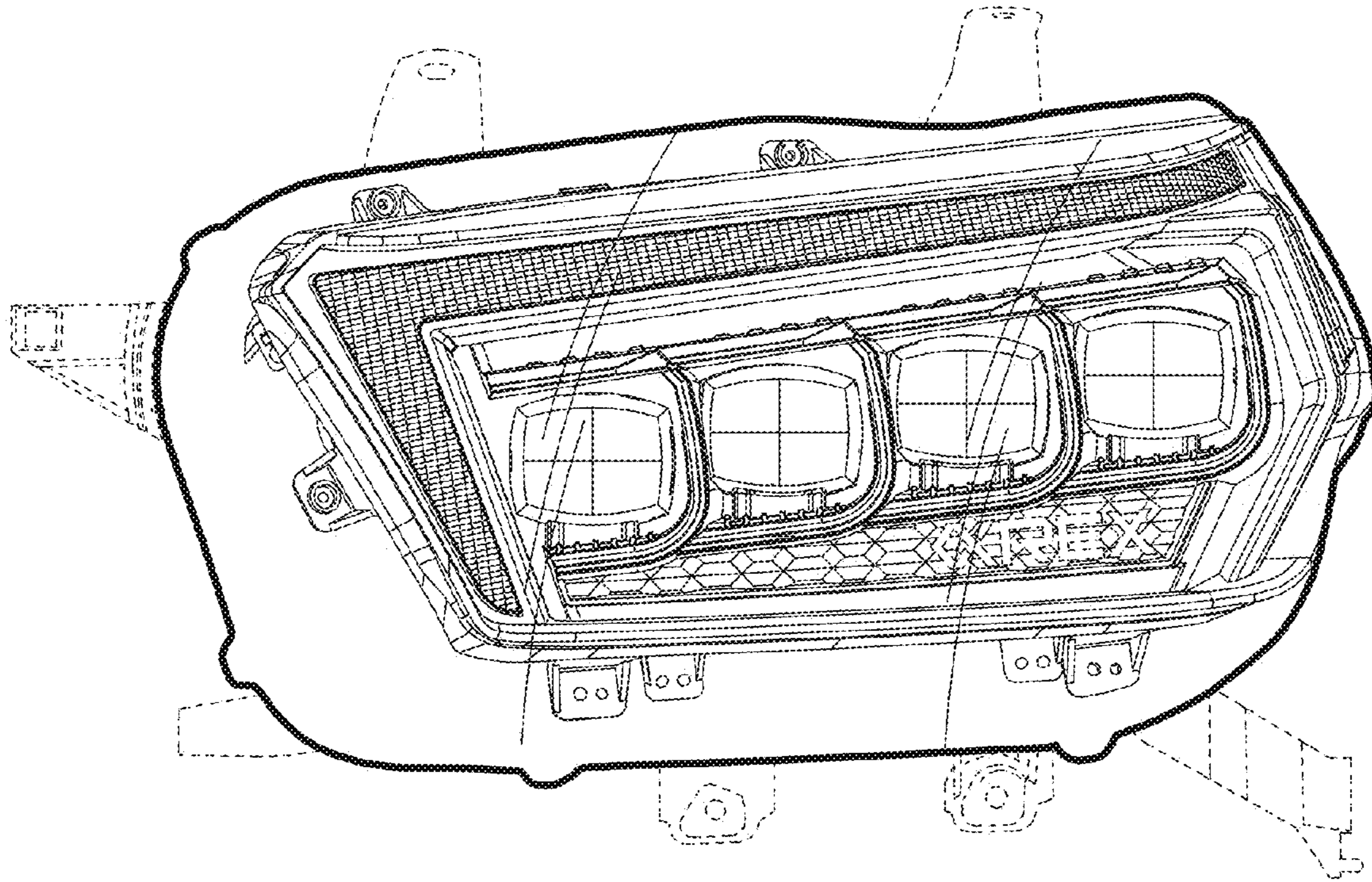

FIG. 3

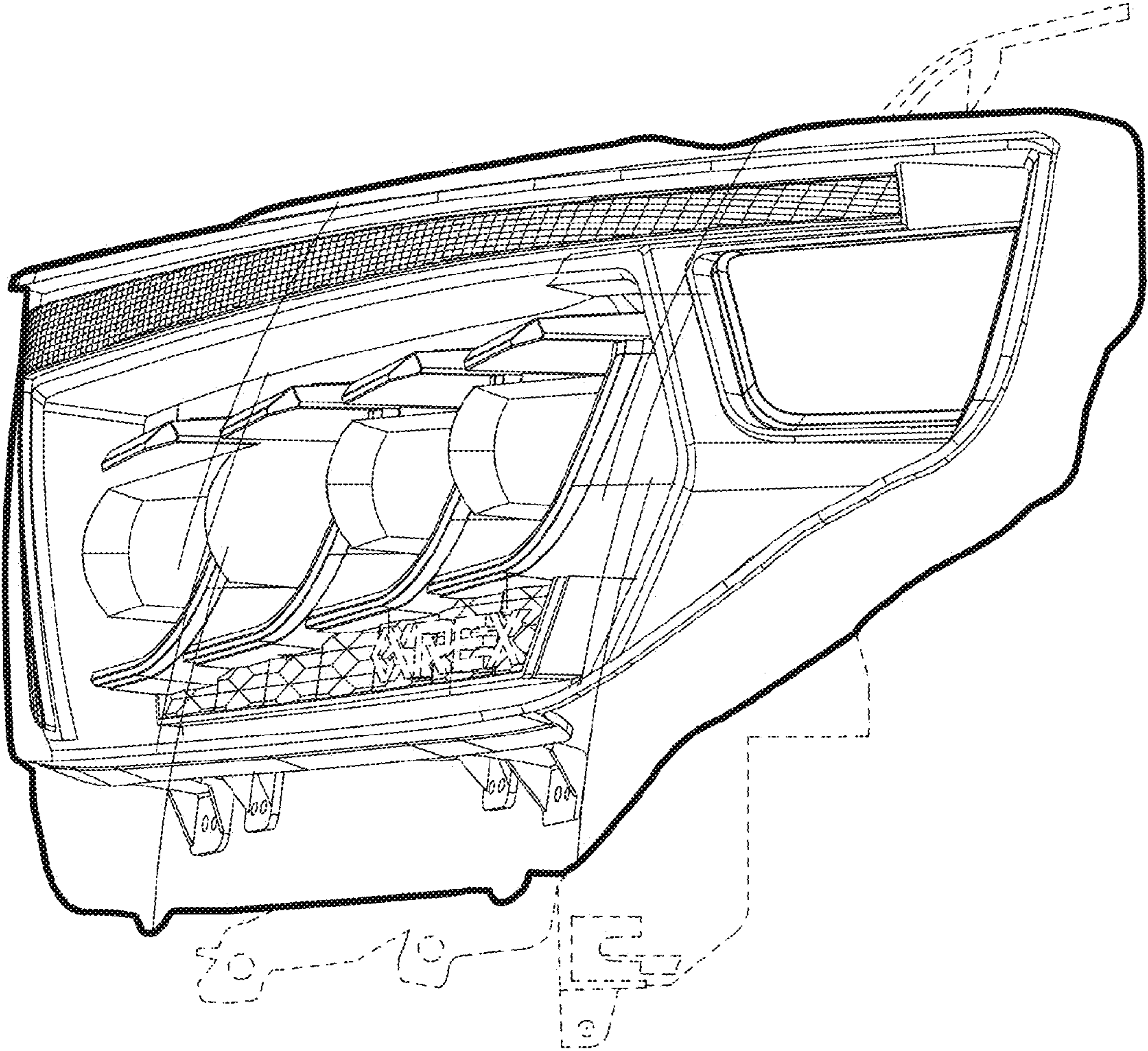

FIG. 4

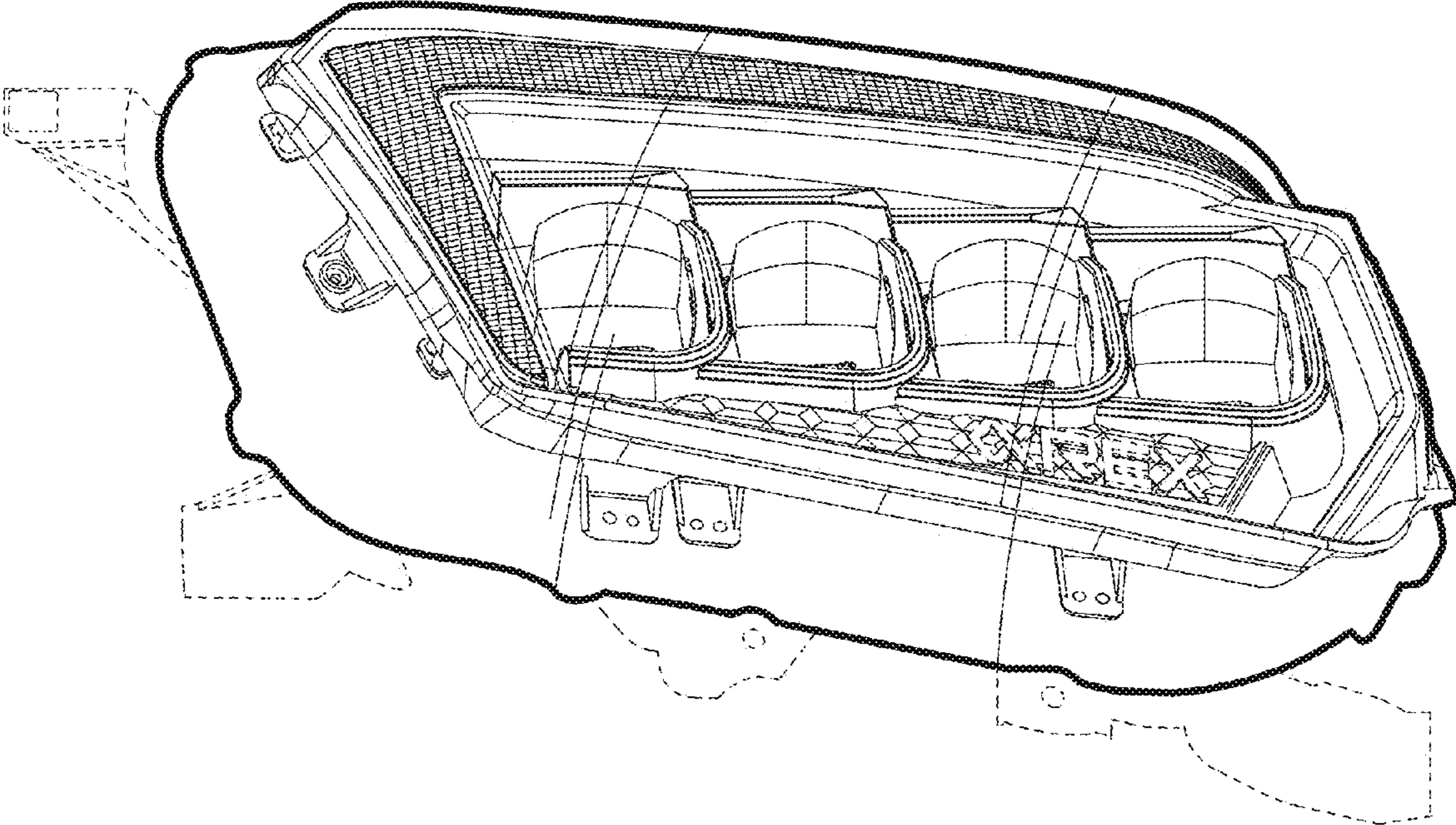

FIG. 5

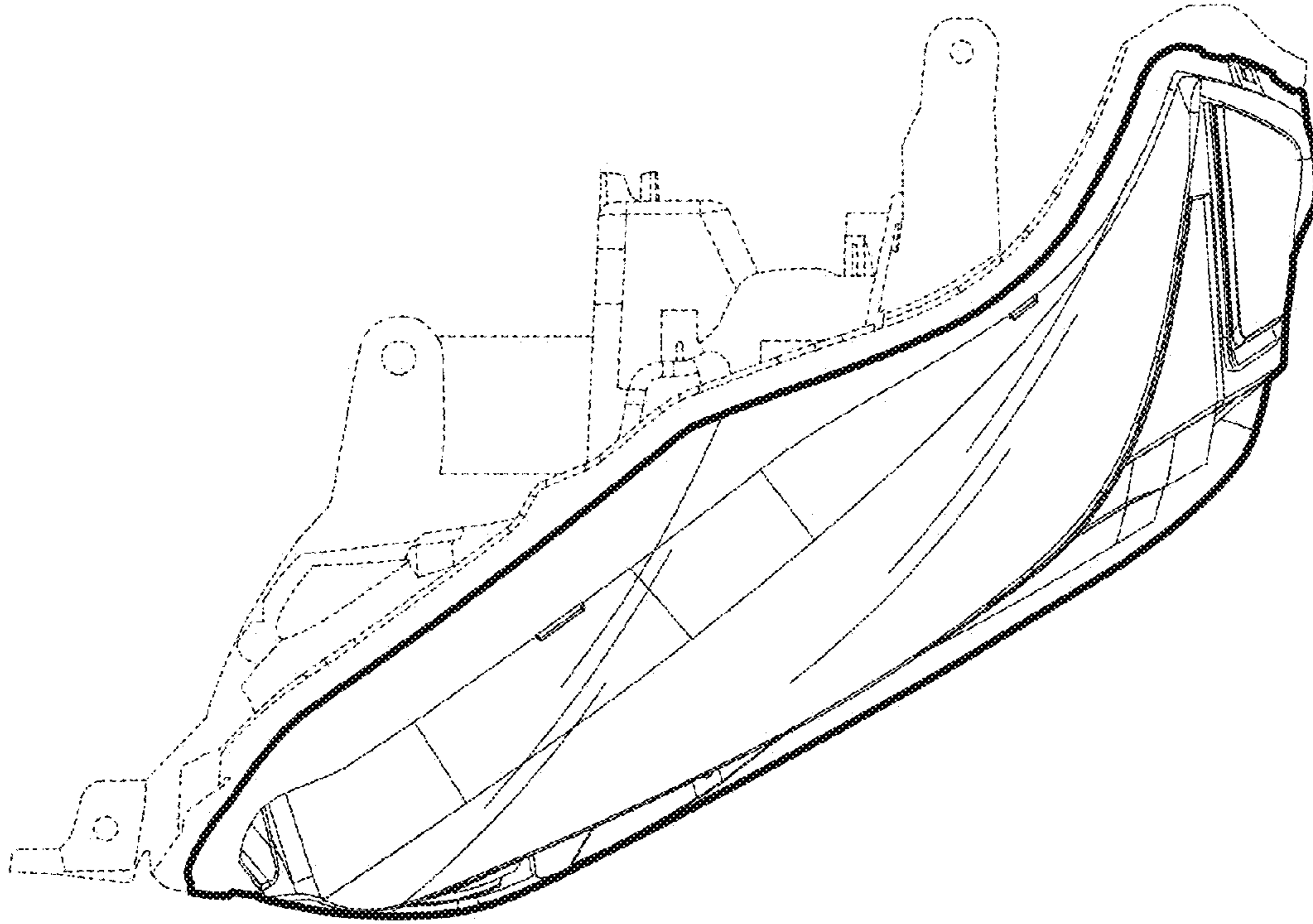

FIG. 6