



US00D962464S

(12) **United States Design Patent** (10) **Patent No.:** **US D962,464 S**  
**Kraus et al.** (45) **Date of Patent:** **\*\* Aug. 30, 2022**

(54) **COOLING PLATE**

(71) Applicant: **pfm medical ag**, Cologne (DE)

(72) Inventors: **Steffen Kraus**, Sandhausen (DE);  
**Erwin Schneider**, Nußloch (DE)

(73) Assignee: **PFM MEDICAL AG**, Cologne (DE)

(\*\*) Term: **15 Years**

(21) Appl. No.: **29/730,145**

(22) Filed: **Apr. 1, 2020**

(30) **Foreign Application Priority Data**

Oct. 7, 2019 (EM) ..... 6989182

(51) **LOC (13) Cl.** ..... **24-01**

(52) **U.S. Cl.**  
USPC ..... **D24/216**

(58) **Field of Classification Search**  
USPC ..... D24/107, 169, 186, 216, 219, 231, 232,  
D24/233; D10/81

(Continued)

(56) **References Cited**

**U.S. PATENT DOCUMENTS**

D326,921 S \* 6/1992 Holbl ..... D24/216  
D330,899 S \* 11/1992 Holbl ..... D24/216

(Continued)

**OTHER PUBLICATIONS**

Pfm Forceps EWF 600—The first wireless electronic forceps for the histologic lab is now available | pfm medical ag—Published Jan. 22, 2020. Retrived from website: [https://www.pfmmedical.com/press/press\\_releases/pfm\\_forceps\\_ewf\\_600\\_the\\_first\\_wireless\\_electronic\\_forceps\\_for\\_the\\_histologic\\_lab\\_is\\_now\\_available/inde.\\*](https://www.pfmmedical.com/press/press_releases/pfm_forceps_ewf_600_the_first_wireless_electronic_forceps_for_the_histologic_lab_is_now_available/inde.*)

*Primary Examiner* — Anhdao Doan

(74) *Attorney, Agent, or Firm* — Venable LLP; Keith G Haddaway

(57) **CLAIM**

The ornamental design for a cooling plate, as shown and described.

**DESCRIPTION**

The patent or application file contains at least on drawing executed in color. Copies of this patent or patent application with color drawing(s) will be provided by the office upon request and payment of the necessary fee.

FIG. 1 is a front view of a cooling plate according to a first embodiment of the present invention;

FIG. 2 is a right side view of a cooling plate according to the first embodiment of the present invention;

FIG. 3 is a back view of a cooling plate according to the first embodiment of the present invention;

FIG. 4 is a top view of a cooling plate according to the first embodiment of the present invention;

FIG. 5 is a bottom view of a cooling plate according to the first embodiment of the present invention;

FIG. 6 is an elevated front right side view of a cooling plate according to the first embodiment of the present invention;

FIG. 7 is an elevated back left side view of a cooling plate according to the first embodiment of the present invention;

FIG. 8 is a front view of a cooling plate according to a second embodiment of the present invention;

FIG. 9 is a right side view of a cooling plate according to the second embodiment of the present invention;

FIG. 10 is a back view of a cooling plate according to the second embodiment of the present invention;

FIG. 11 is a top view of a cooling plate according to the second embodiment of the present invention;

FIG. 12 is a bottom view of a cooling plate according to the second embodiment of the present invention;

FIG. 13 is an elevated front right side view of a cooling plate according to the second embodiment of the present invention; and,

(Continued)

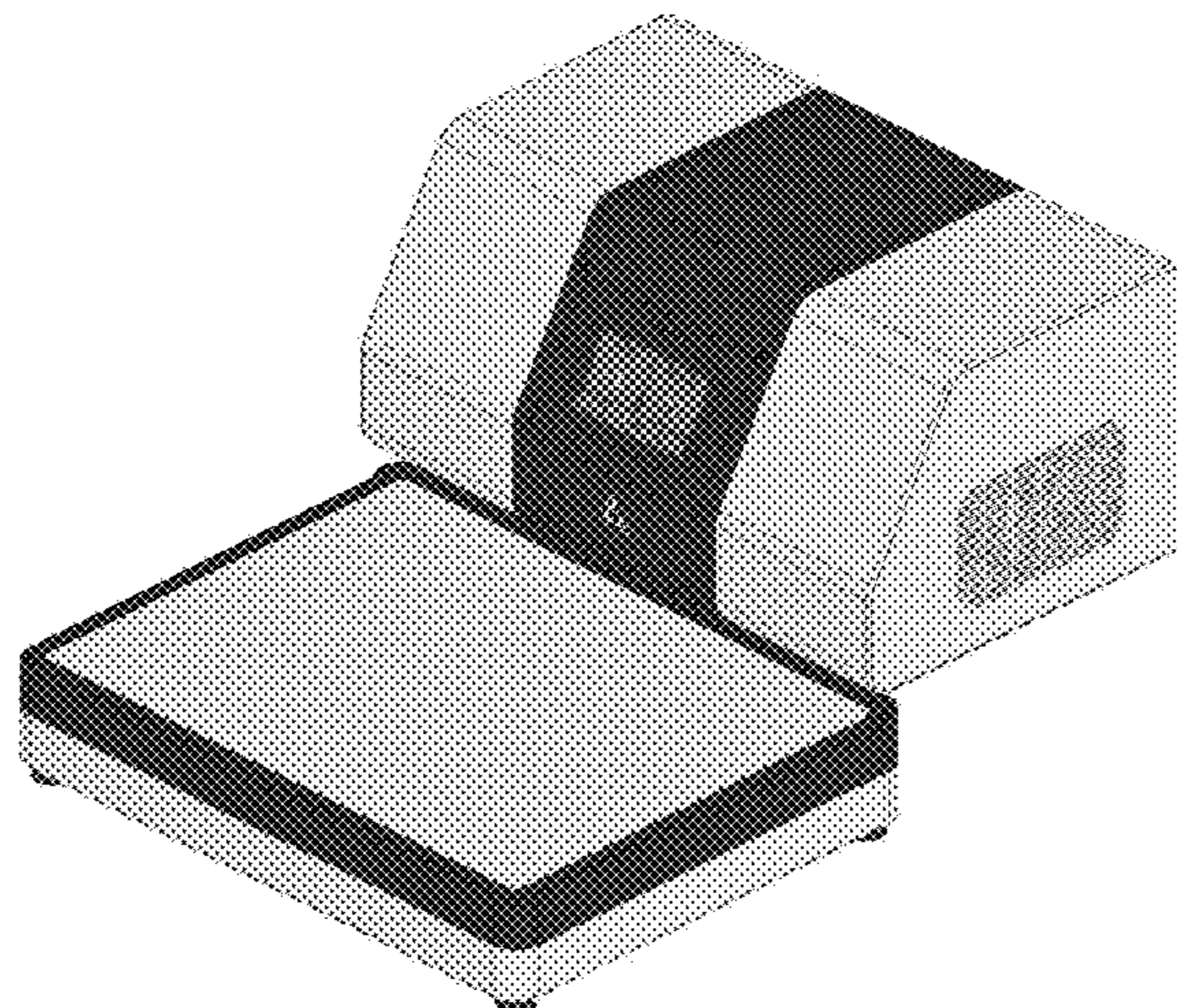

FIG. 14 is an elevated back left side view of a cooling plate according to the second embodiment of the present invention.

**1 Claim, 14 Drawing Sheets  
(7 of 14 Drawing Sheet(s) Filed in Color)**

**(58) Field of Classification Search**

CPC ..... G01N 1/06; G01N 1/31; G01N 1/061;  
G01N 2001/065; Y10T 83/202; Y10T  
436/11; Y10T 436/112499

See application file for complete search history.

**(56) References Cited**

U.S. PATENT DOCUMENTS

D761,439	S	*	7/2016	Ruiz Robles	.....	D24/232
D810,315	S	*	2/2018	Hoelbl	.....	D24/232
D810,316	S	*	2/2018	Hoelbl	.....	D24/232
D872,297	S	*	1/2020	Zhou	.....	D24/216
D903,894	S	*	12/2020	Zhou	.....	D24/216
D903,895	S	*	12/2020	Zhou	.....	D24/216
D917,066	S	*	4/2021	Esterberg	.....	D24/232
2004/0261597	A1	*	12/2004	Thiem	.....	G01N 1/06 83/703
2020/0200650	A1	*	6/2020	Fan	.....	G01N 1/06

\* cited by examiner



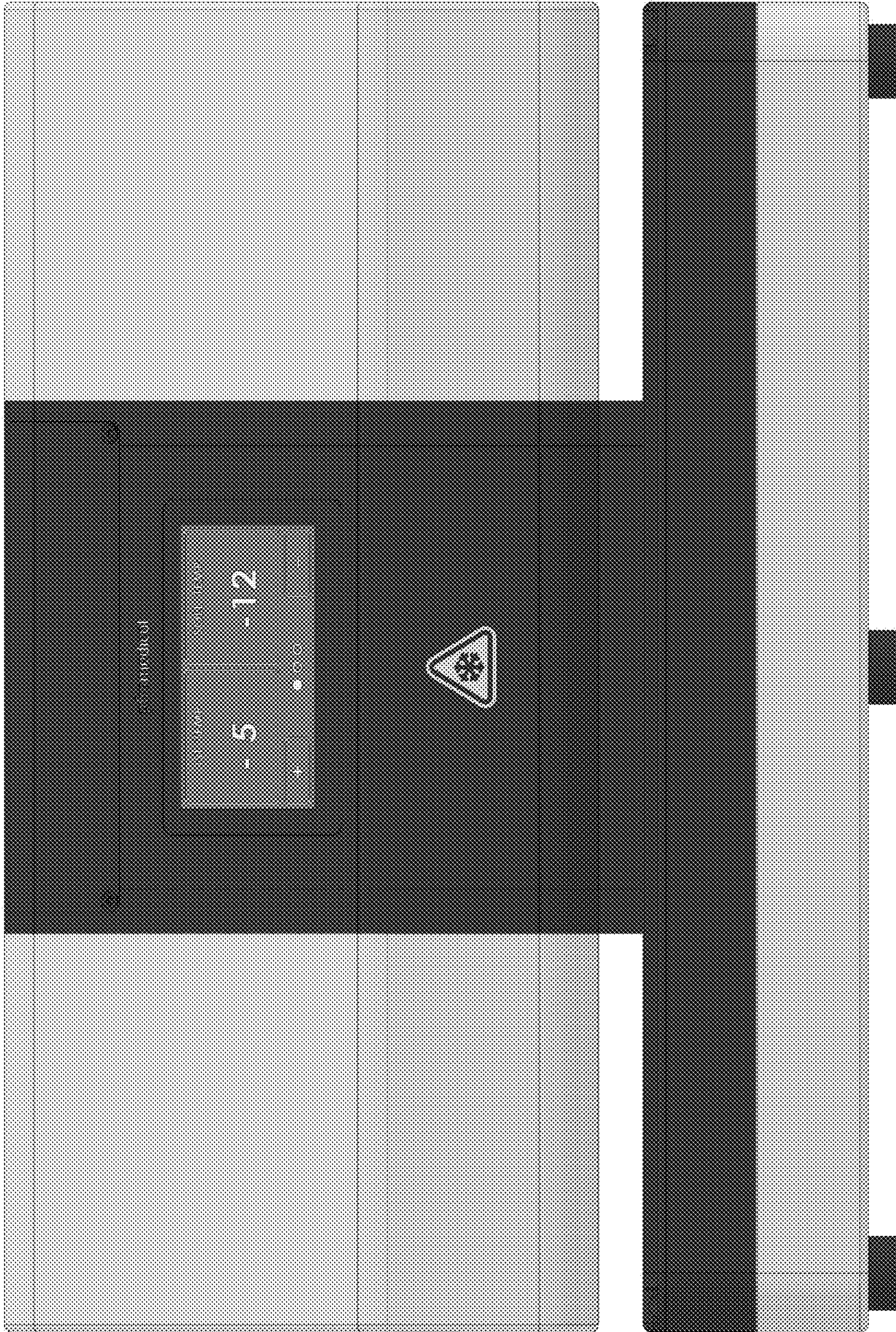

Figure 1



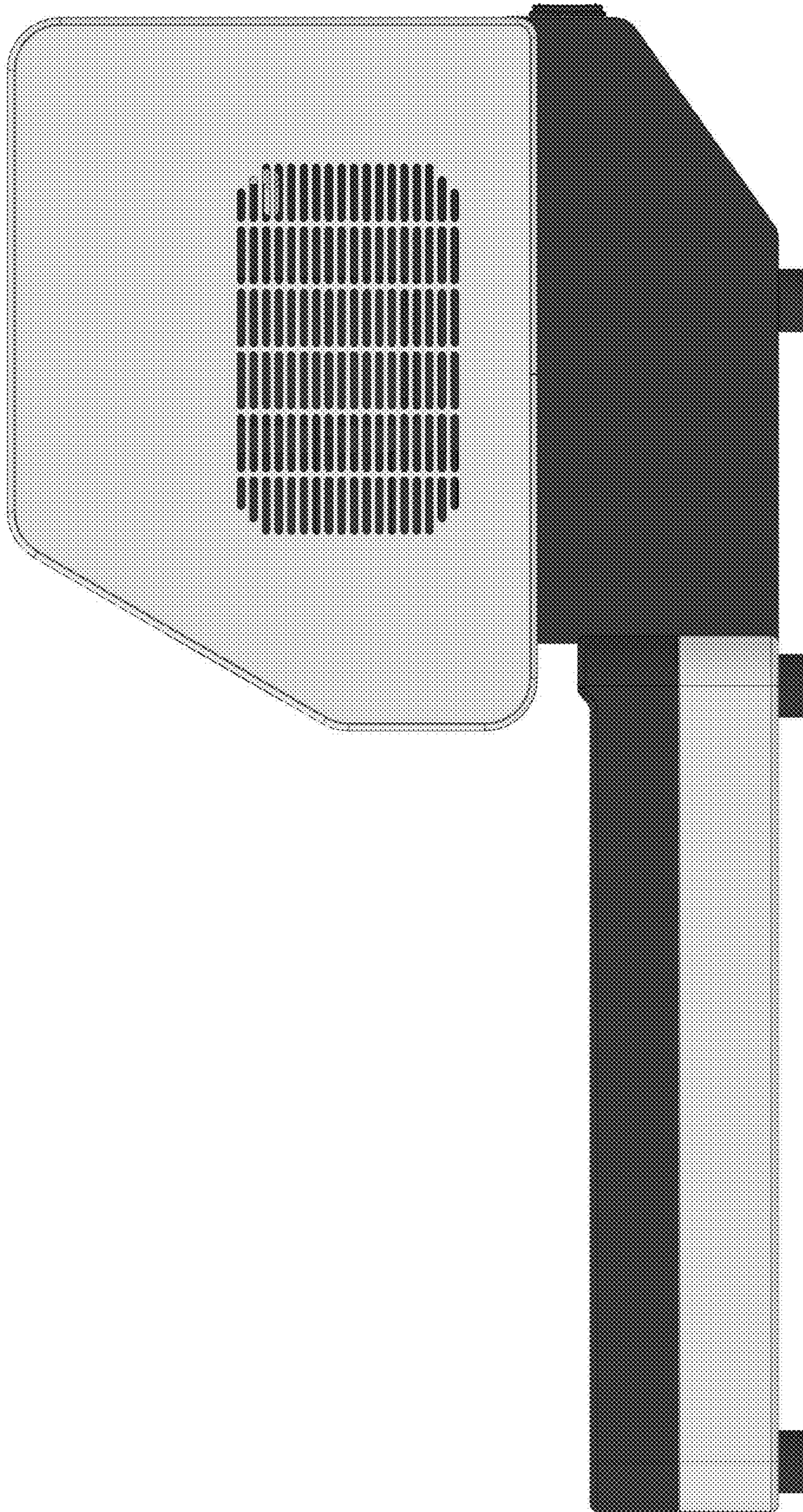

Figure 2







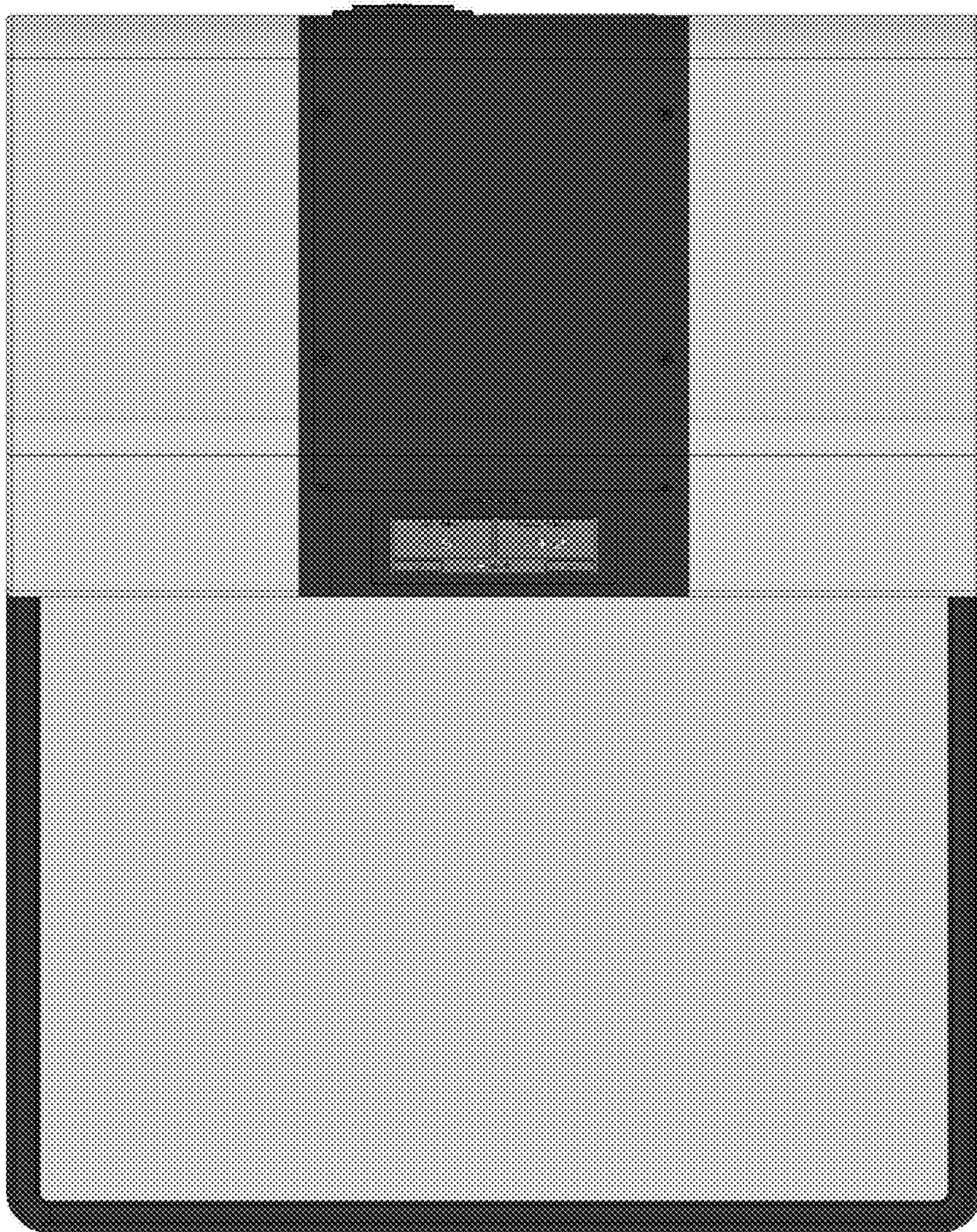

Figure 4



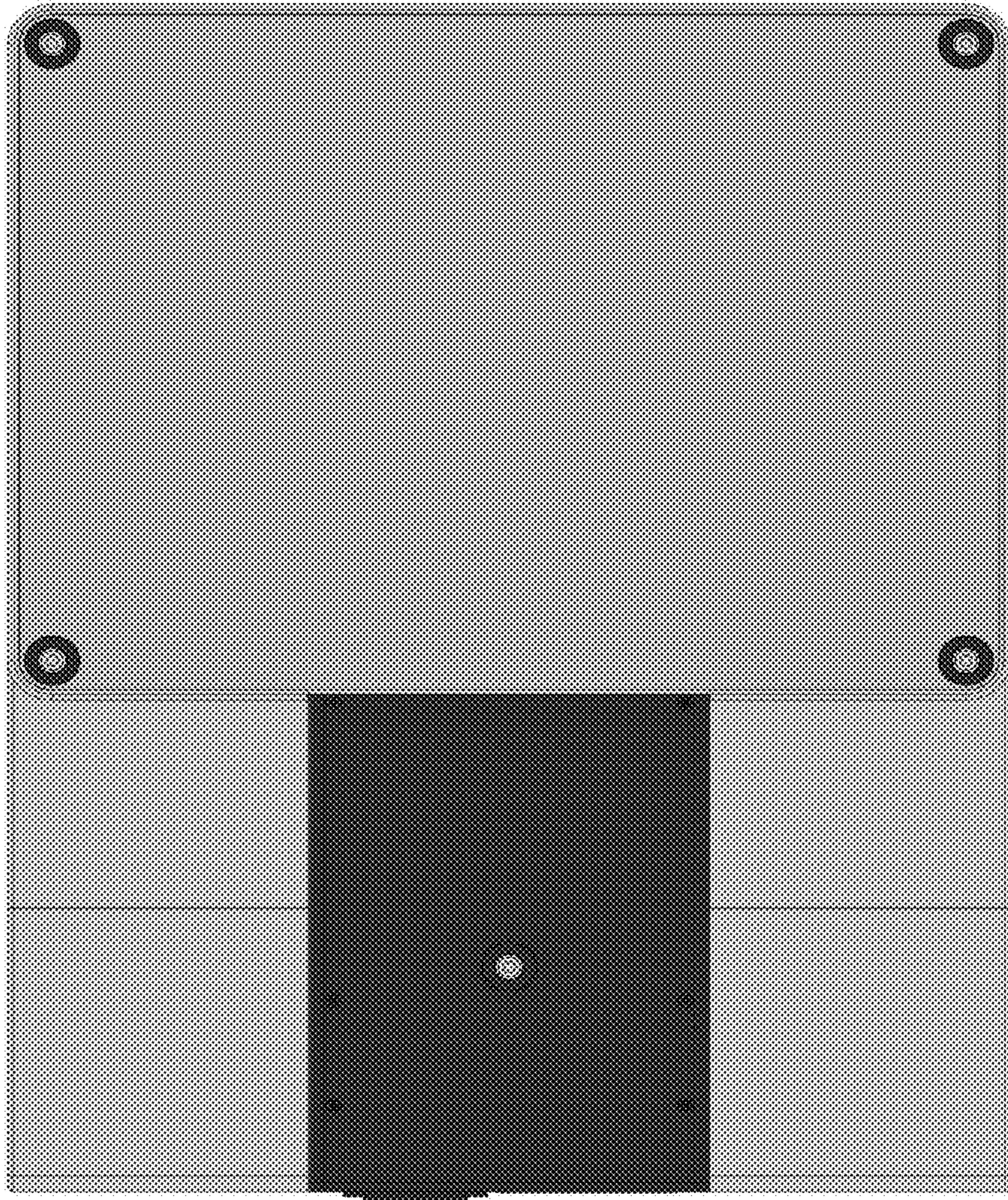

Figure 5



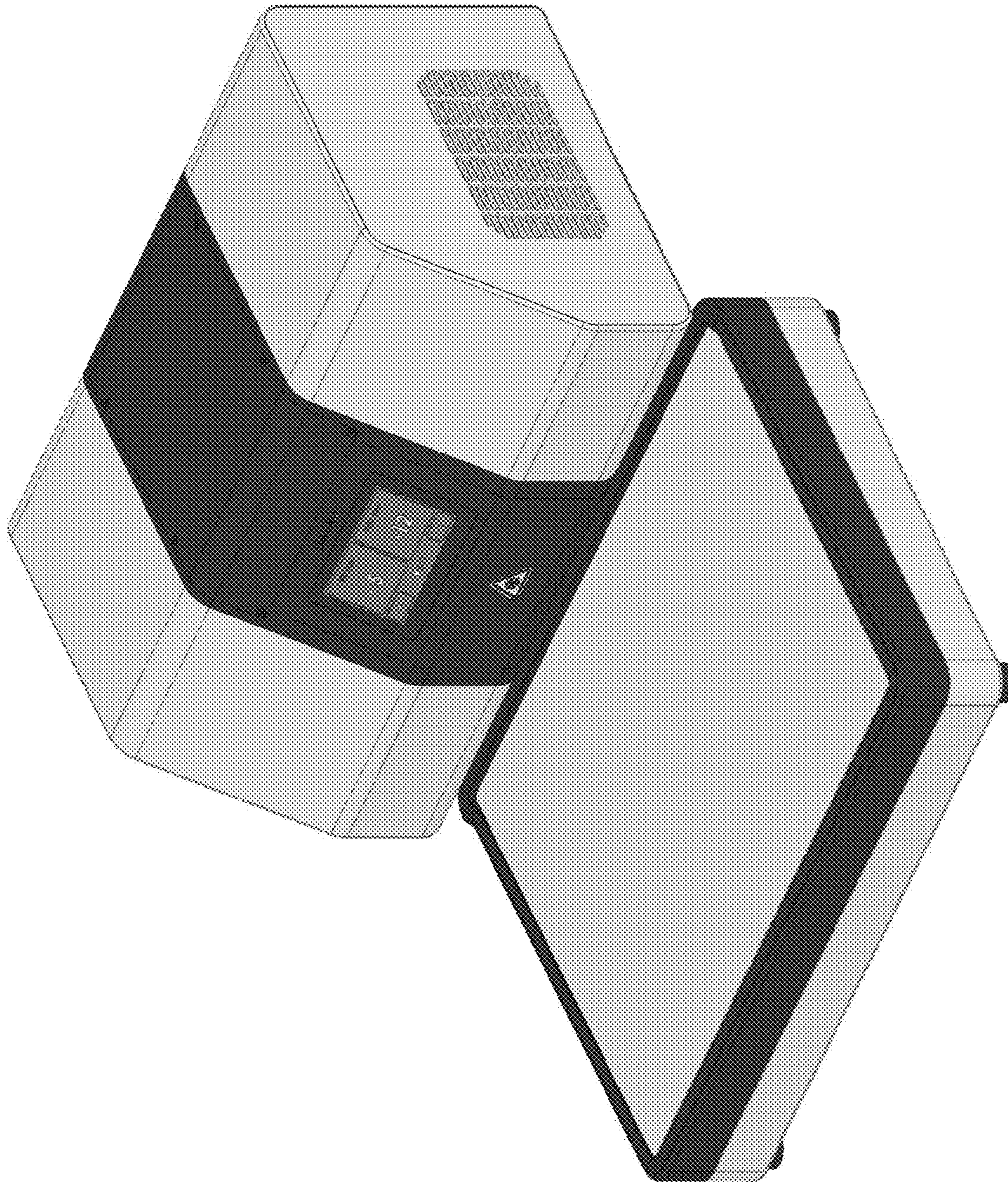

Figure 6



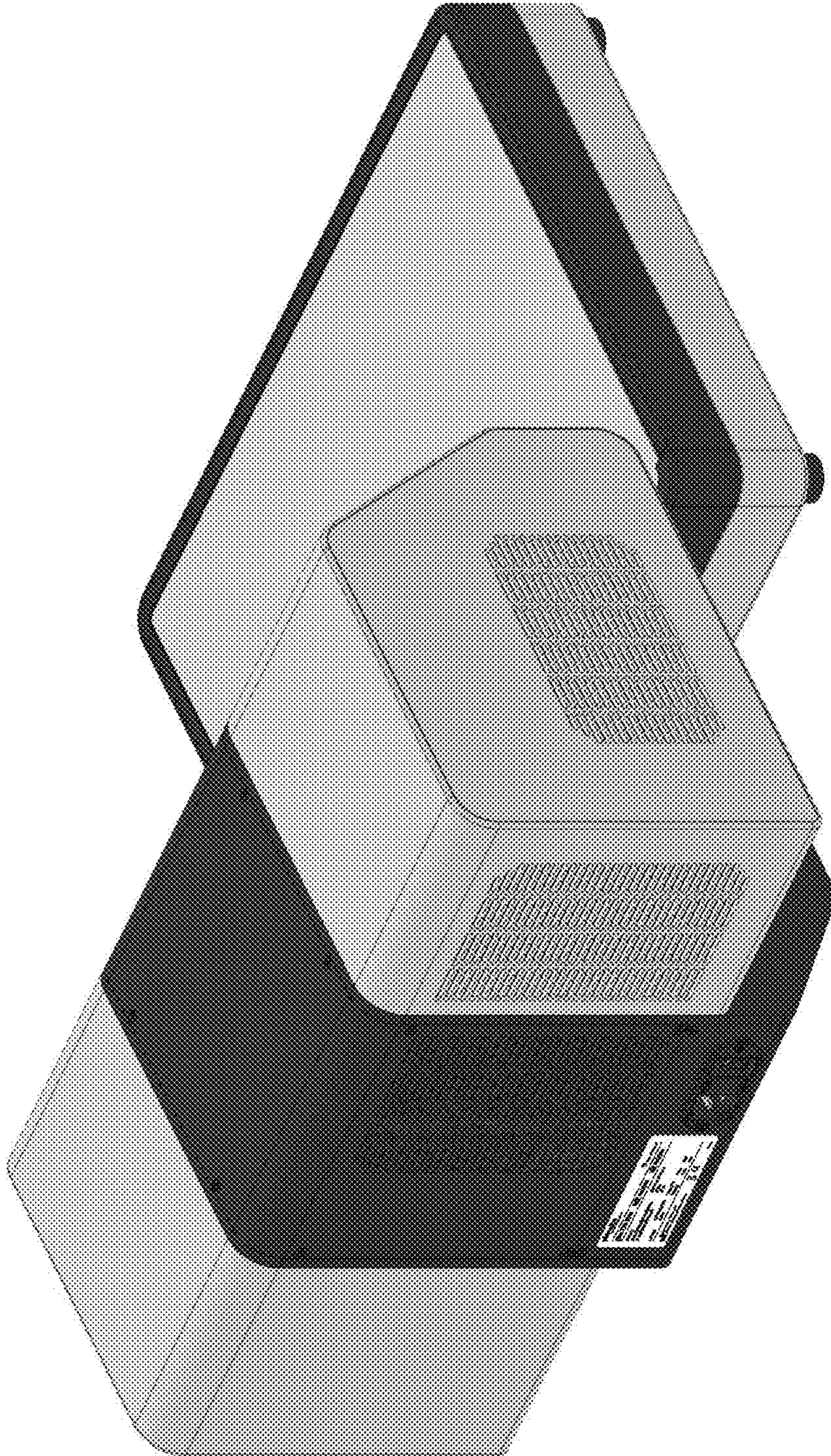

Figure 7



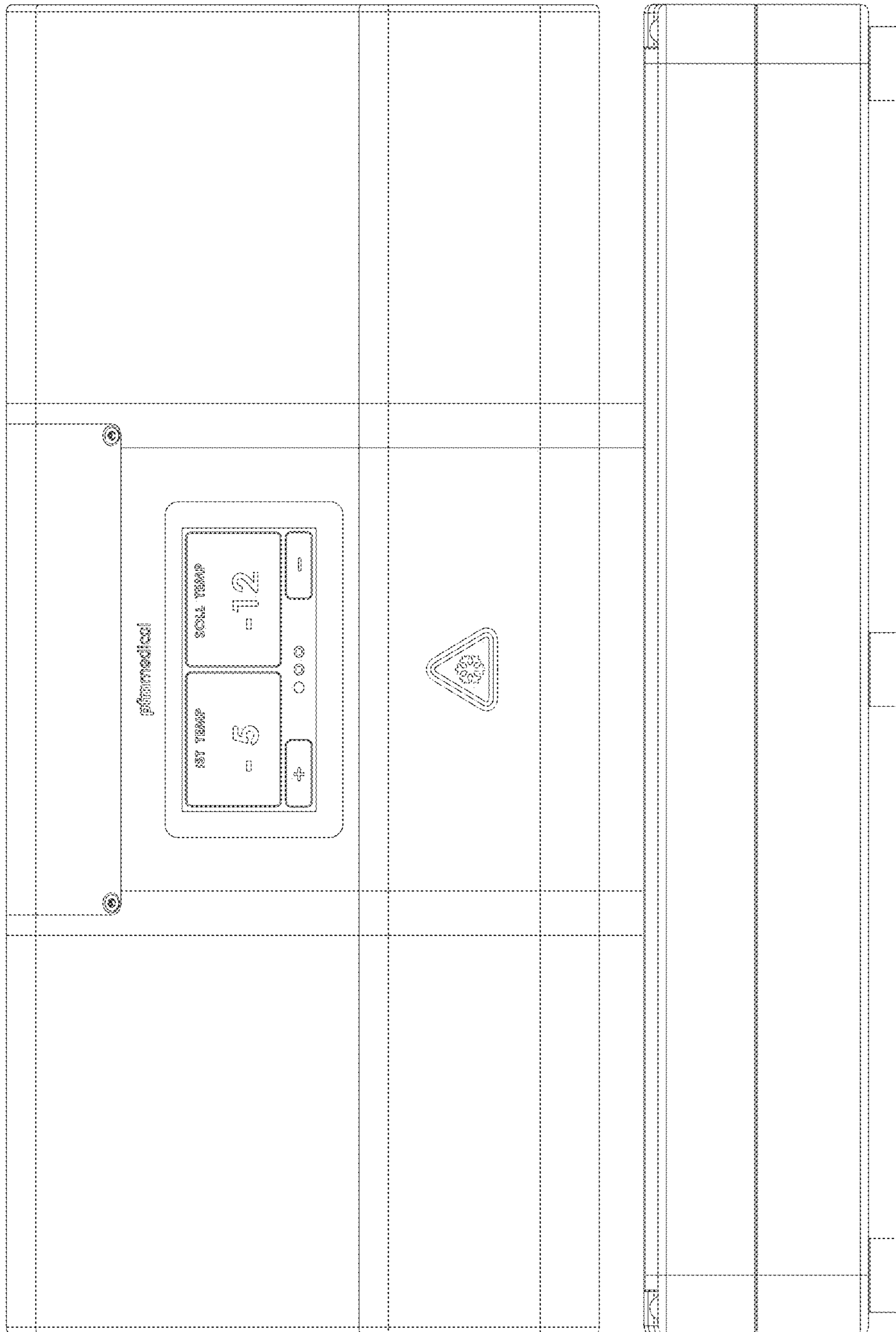

Figure 8



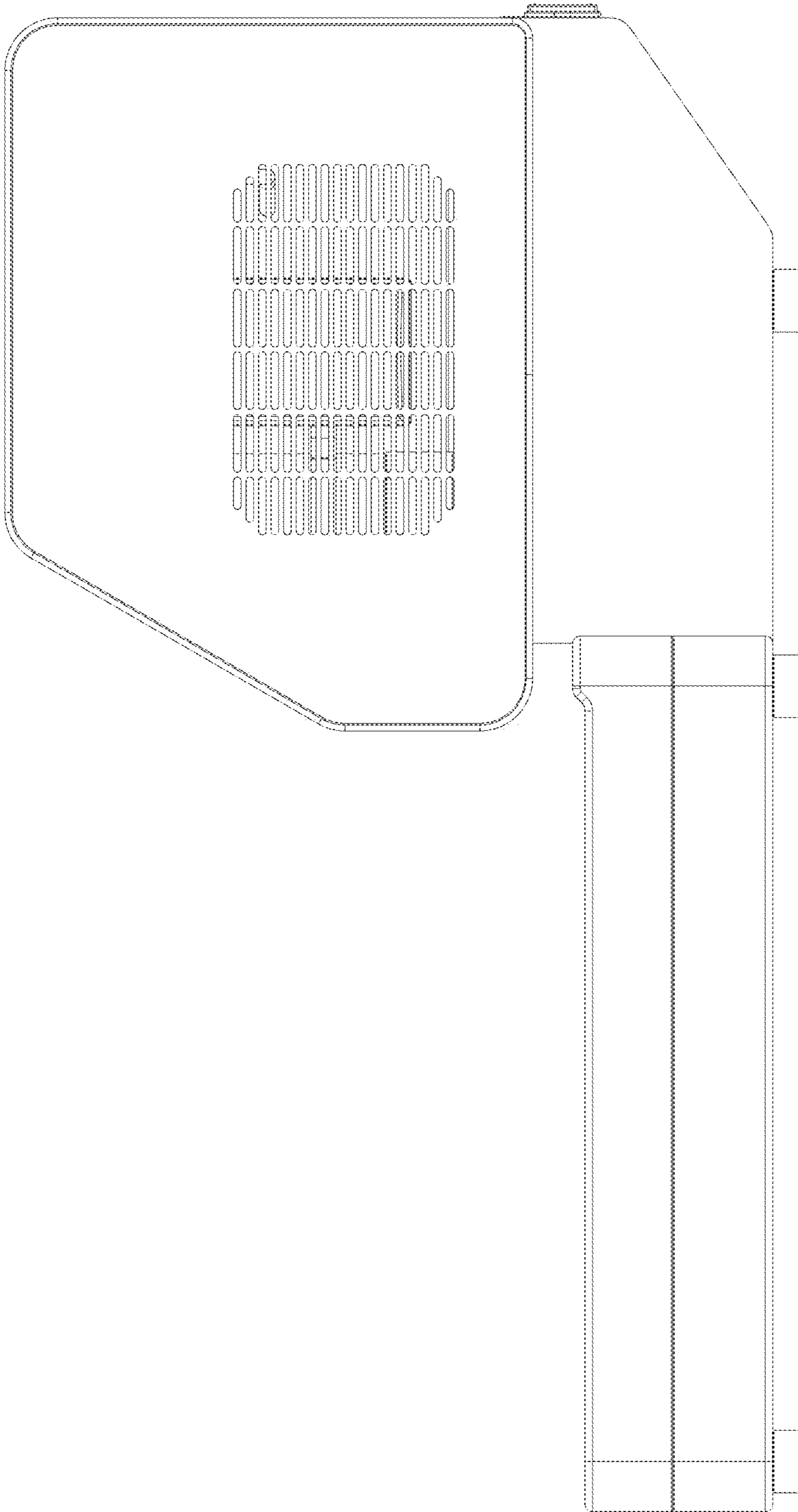

Figure 9







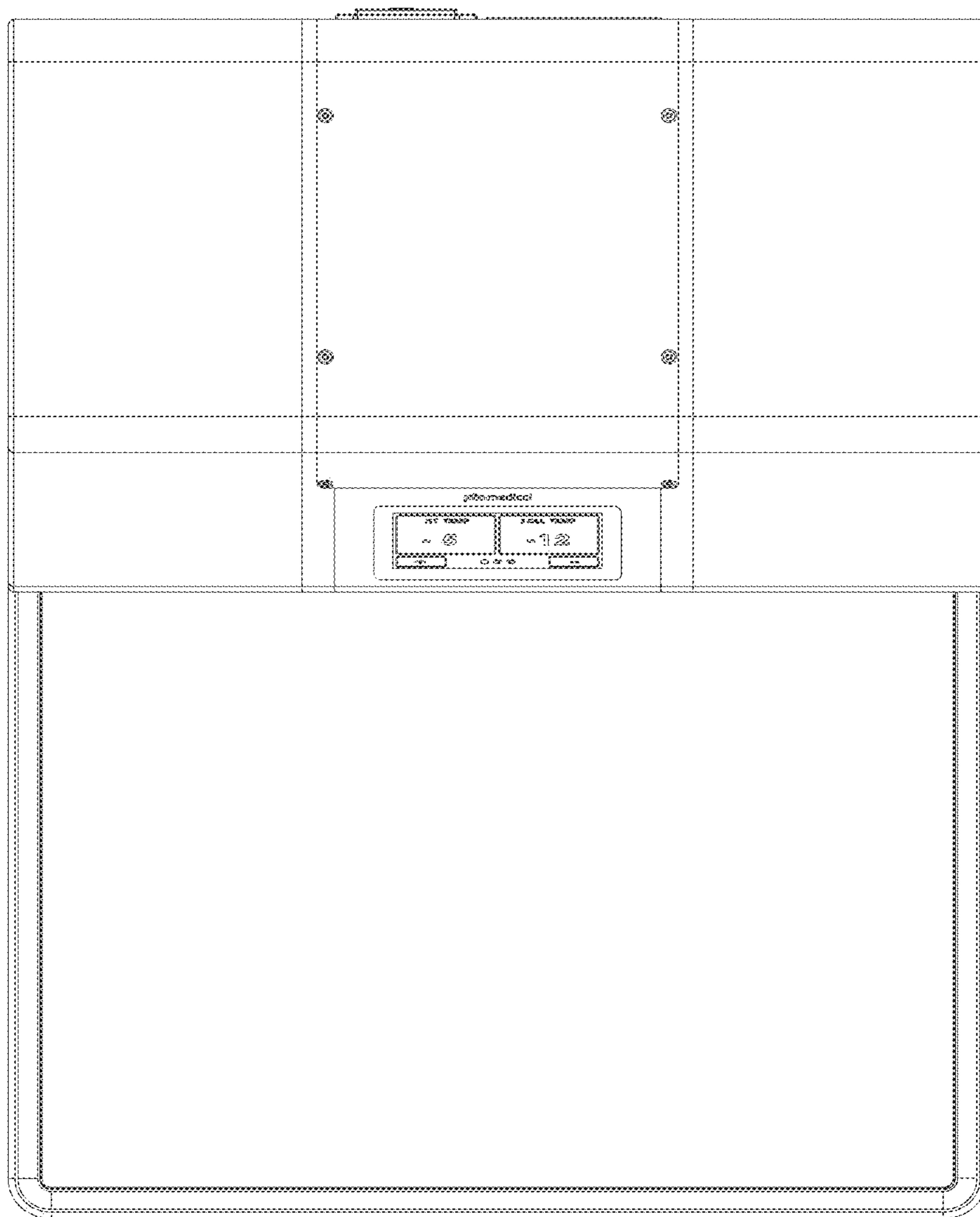

Figure 11



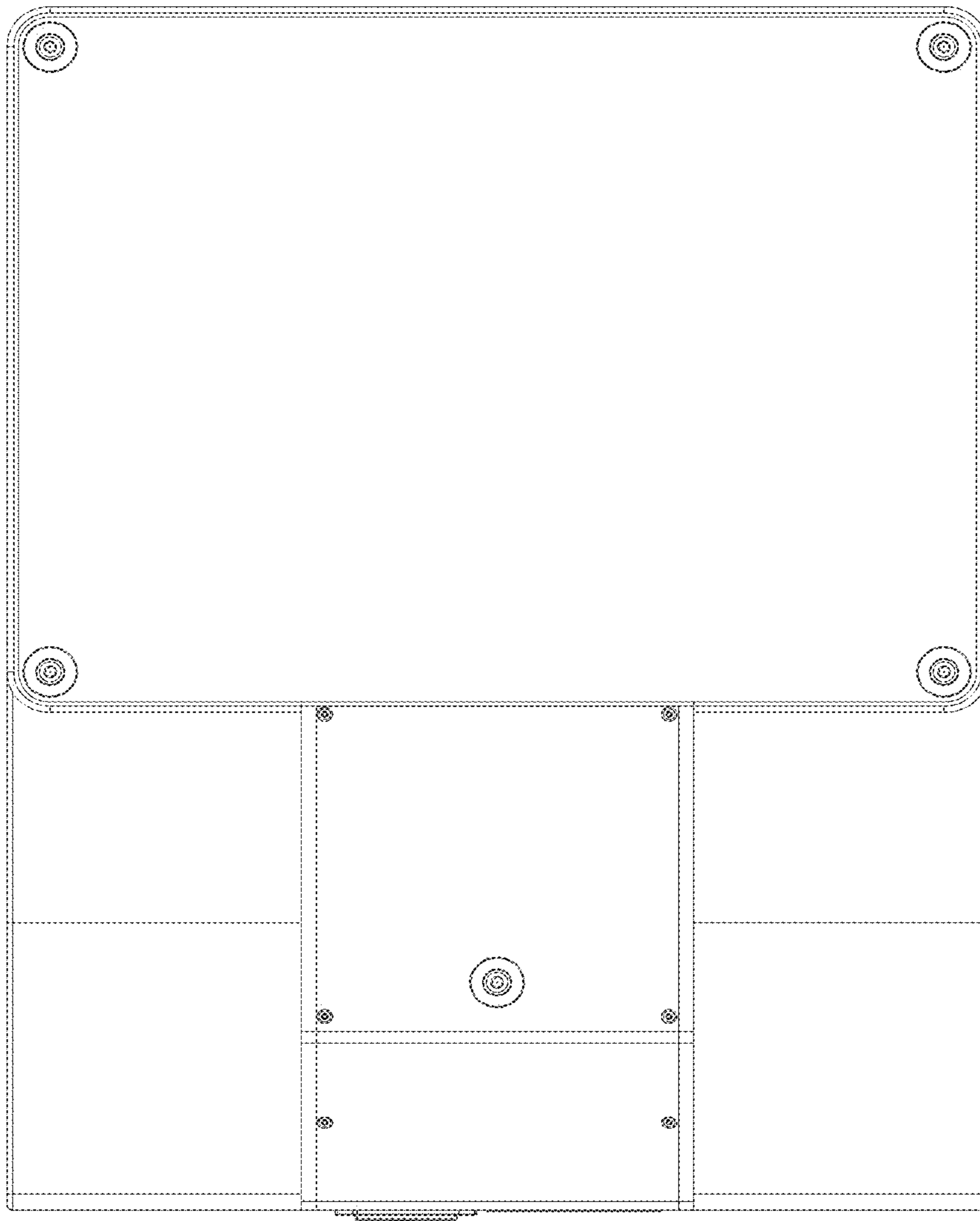

Figure 12



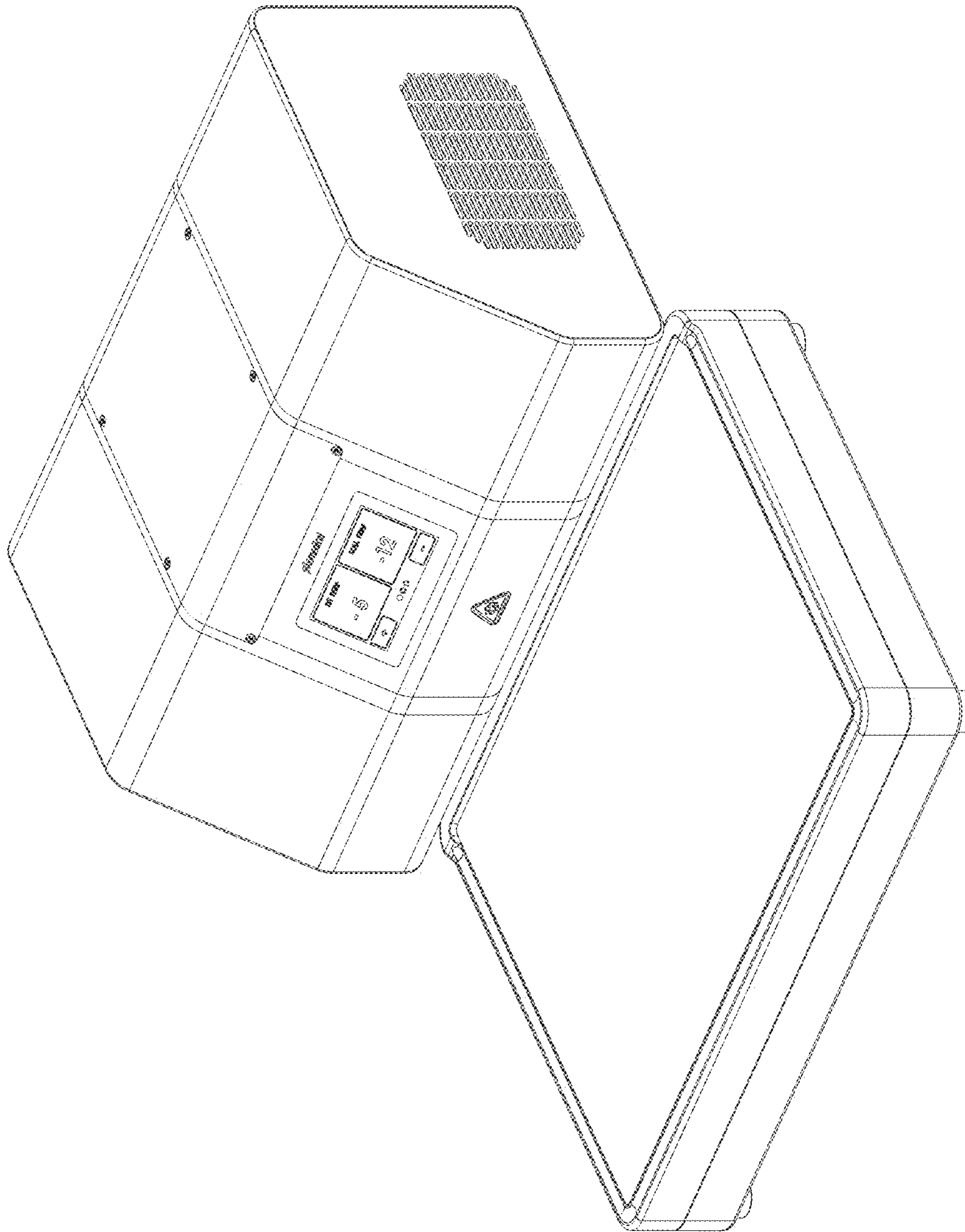

Figure 13



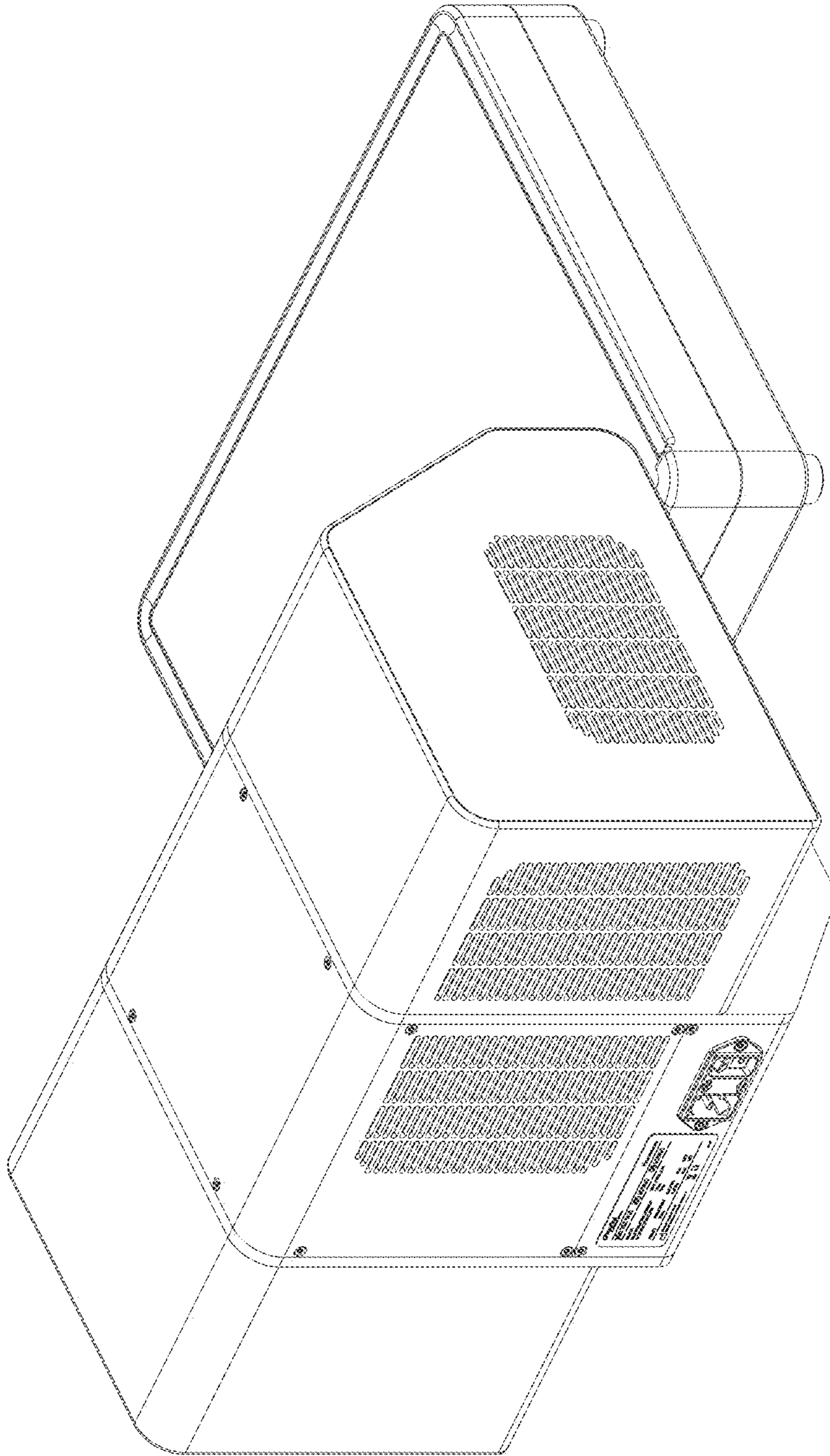

Figure 14