



US00D962409S

(12) **United States Design Patent** (10) **Patent No.:** **US D962,409 S**
Lee (45) **Date of Patent:** **** Aug. 30, 2022**

(54) **AIR PURIFIER**

D868,229 S * 11/2019 Chen D23/332
D869,543 S * 12/2019 Meraz D16/237
D930,135 S * 9/2021 Jung D23/364

(71) Applicant: **Bloomy Lotus Ltd**, Hong Kong (HK)

(72) Inventor: **Leander Lee**, Hong Kong (HK)

(73) Assignee: **Bloomy Lotus Ltd**, Hong Kong (HK)

(**) Term: **15 Years**

(21) Appl. No.: **29/757,151**

(22) Filed: **Nov. 3, 2020**

(30) **Foreign Application Priority Data**

May 8, 2020 (HK) 2016116.8

(51) **LOC (13) Cl.** **23-04**

(52) **U.S. Cl.**
USPC **D23/364**

(58) **Field of Classification Search**
USPC D23/332, 336, 356, 359, 364-366, 378,
D23/499; D14/204, 214, 240, 314, 496
CPC F24F 1/029; F24F 1/035; F24F 1/0287;
F24F 6/06; F24F 6/14; F24F 13/06; F24F
13/20; F24F 13/222; F24F 3/16; F24F
3/1405; A61L 9/03; A61L 9/22
See application file for complete search history.

(56) **References Cited**

U.S. PATENT DOCUMENTS

D326,730 S * 6/1992 Ciceri D26/85
D345,196 S * 3/1994 Kelly D23/366
D380,564 S * 7/1997 Yuen D26/85
D425,560 S * 5/2000 Yuen D10/2
D686,772 S * 7/2013 Waltz D26/118
D690,281 S * 9/2013 Carr D14/204
D690,679 S * 10/2013 Chang D14/204
D696,391 S * 12/2013 Sidell D23/366
D762,830 S * 8/2016 Lewis D23/332
D793,362 S * 8/2017 Fischer D14/214

FOREIGN PATENT DOCUMENTS

HK 1801430-0001 * 12/2018
HK 1914035-0001 * 11/2019

OTHER PUBLICATIONS

Portable Cell Phone UV Light Sanitizer Box, first available Oct. 19, 2020[online], [site visited May 4, 2022]. Available from internet, URL:<<https://www.amazon.com/Portable-Sanitizer-Wireless-Charging-Sterilizer/dp/B08LCW5WYL>> (Year: 2020).*

* cited by examiner

Primary Examiner — David G Muller
Assistant Examiner — Jamaal Rasheed

(57) **CLAIM**

The ornamental design for an air purifier, as shown and described.

DESCRIPTION

FIG. 1 is a front elevational view of an air purifier showing my new design;
FIG. 2 is a rear elevational view thereof;
FIG. 3 is a left side view thereof;
FIG. 4 is a right side view thereof;
FIG. 5 is a top plan view thereof;
FIG. 6 is a bottom plan view thereof;
FIG. 7 is a top, front and right side perspective view thereof;
and,
FIG. 8 is a bottom, rear and right side perspective view thereof.
The broken lines in the drawings illustrate portions of the air purifier which form no part of the claimed design.

1 Claim, 8 Drawing Sheets

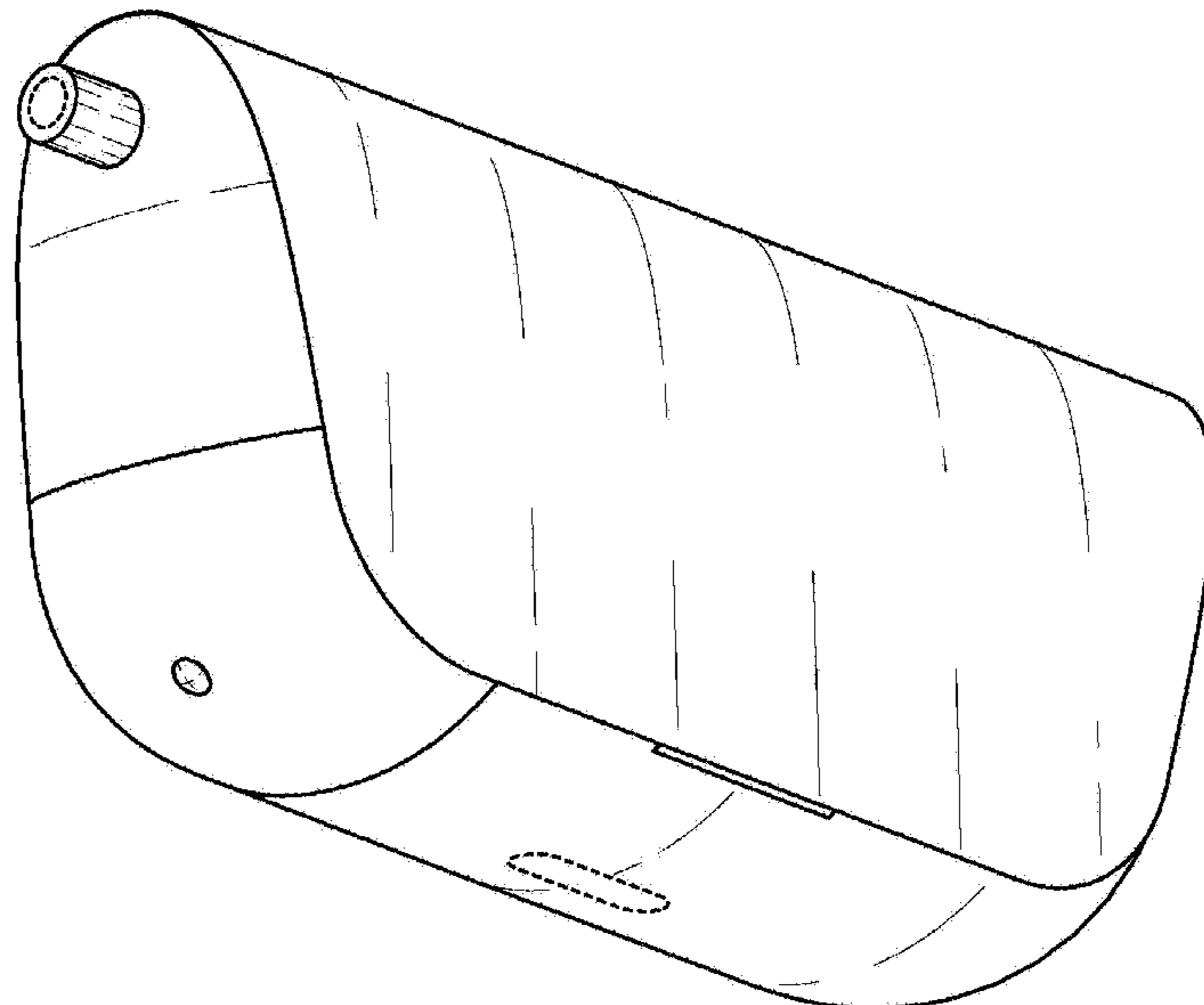

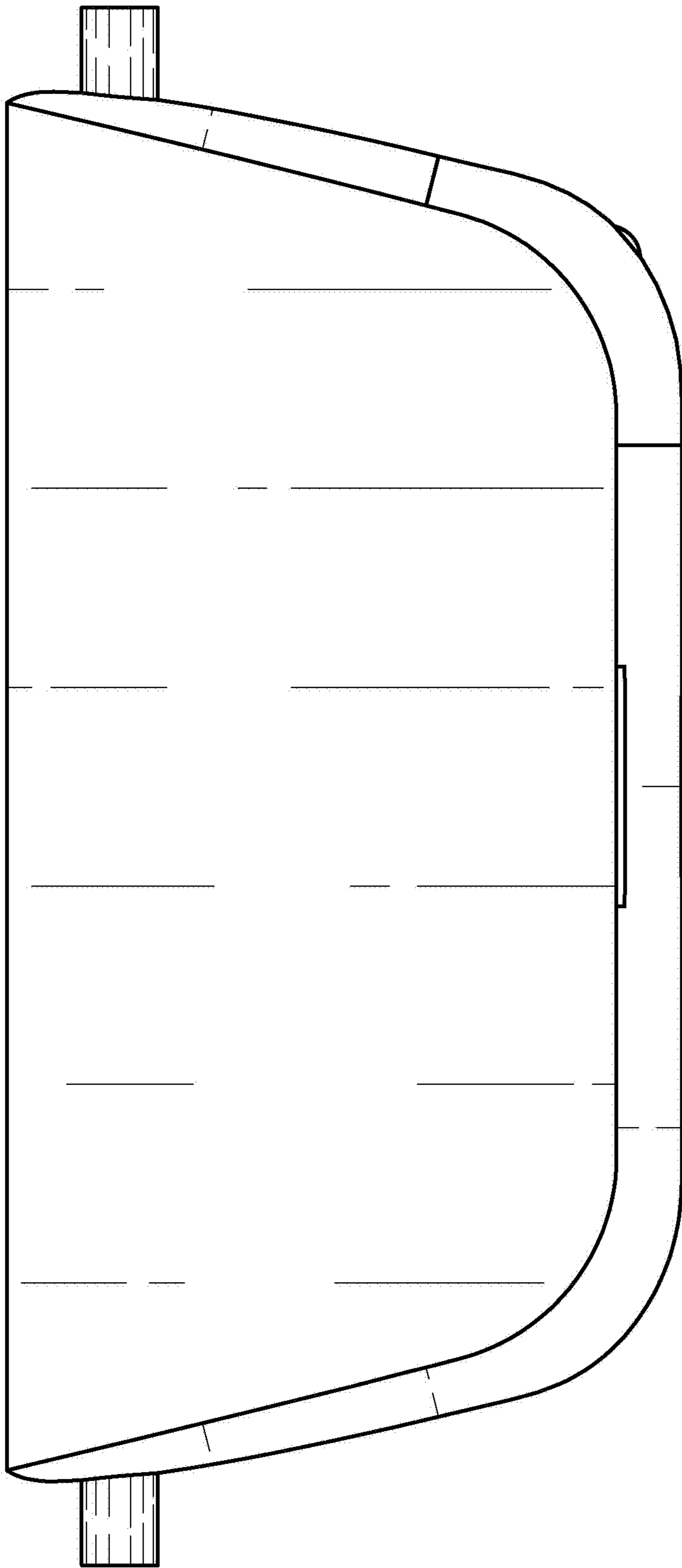

Fig. 1

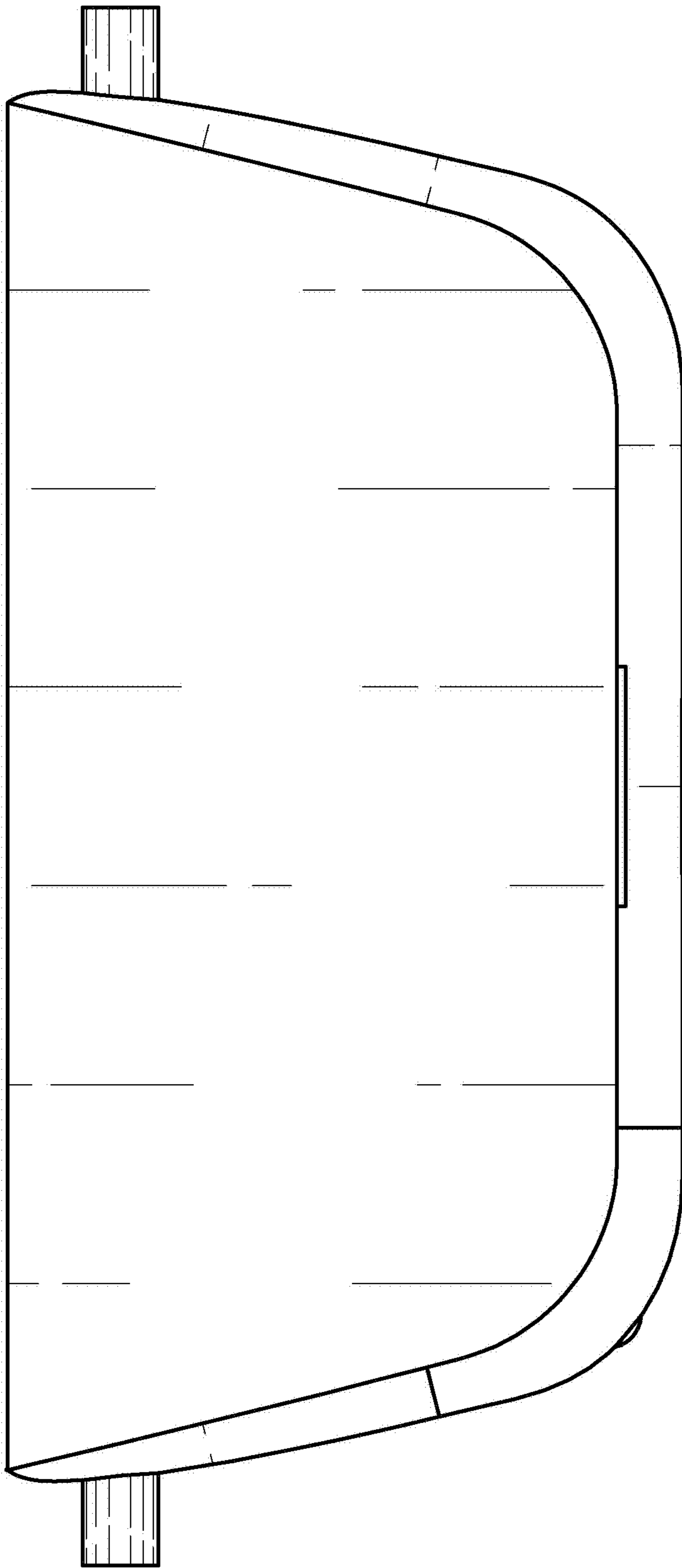

Fig. 2

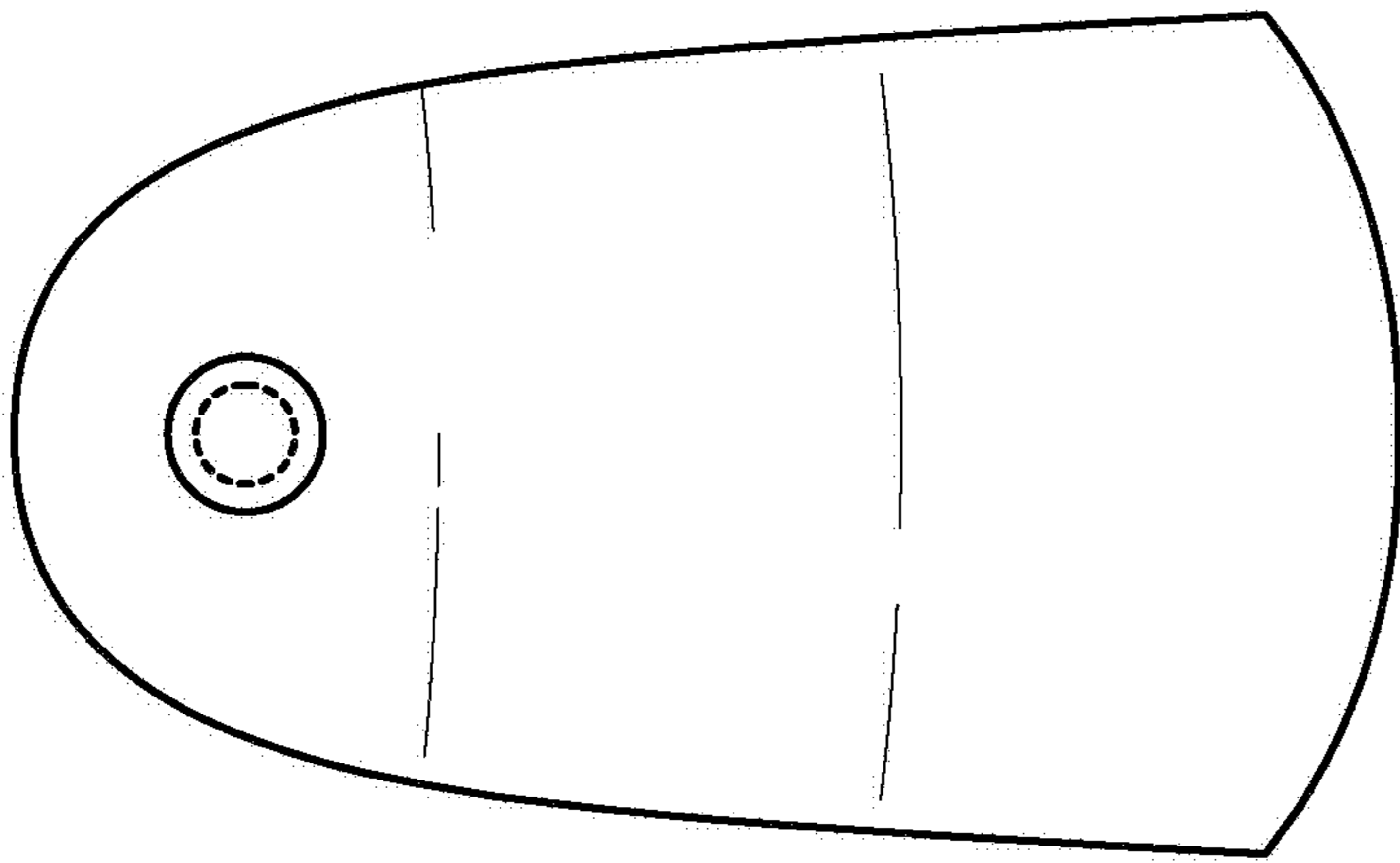

Fig. 3

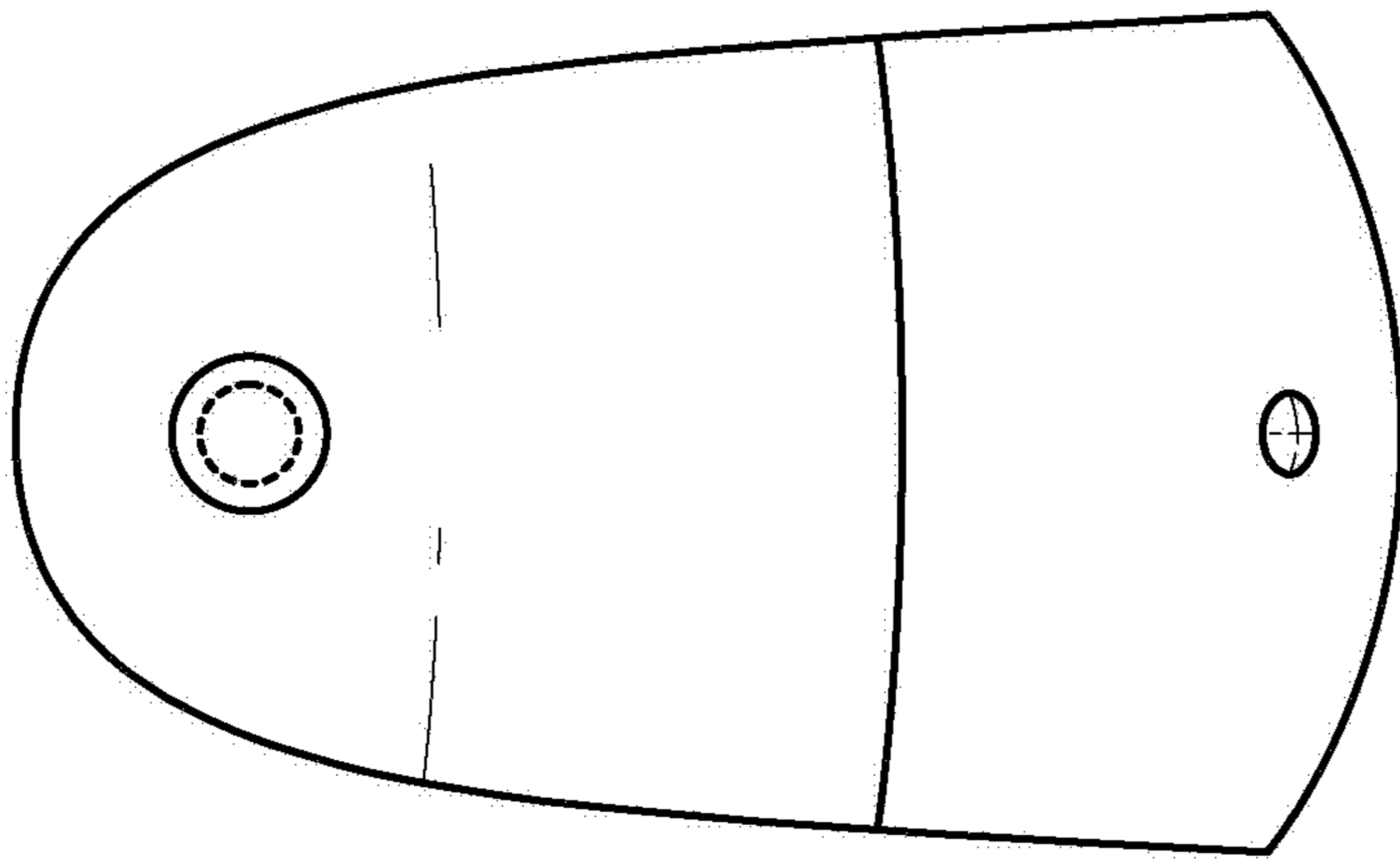

Fig. 4

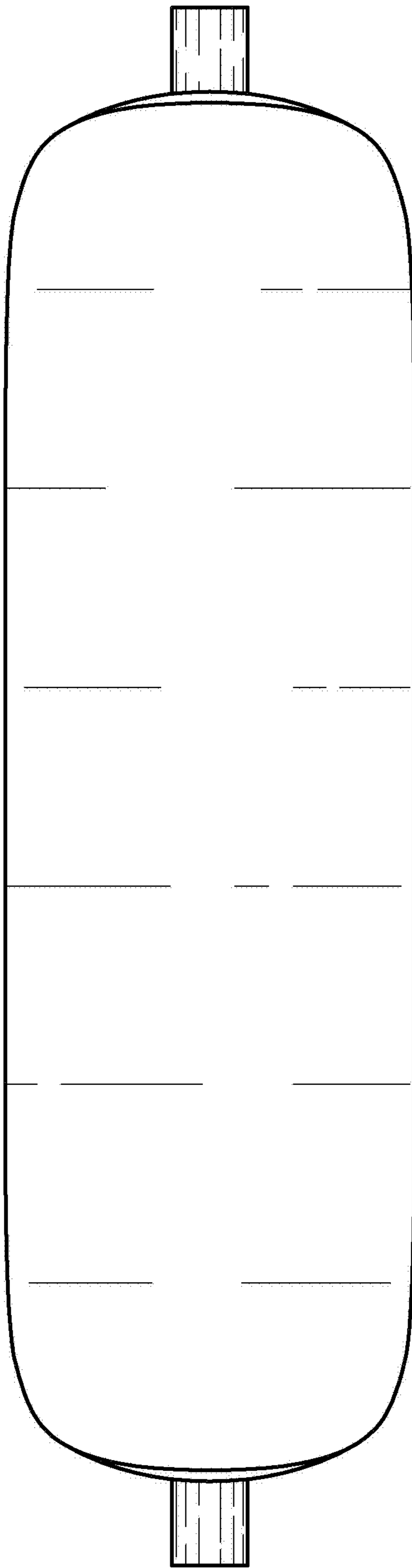

Fig. 5

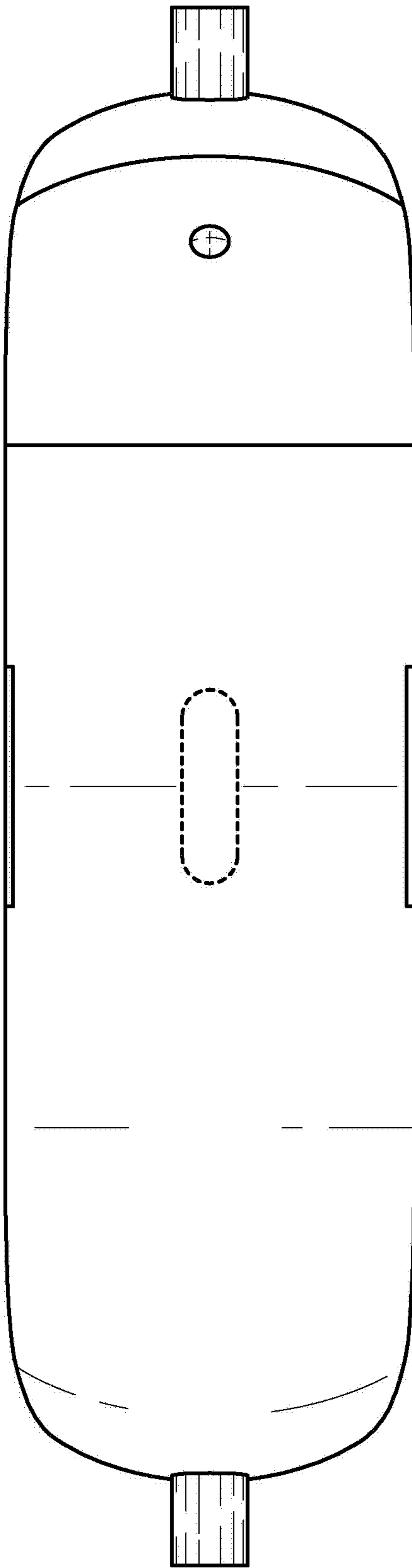

Fig. 6

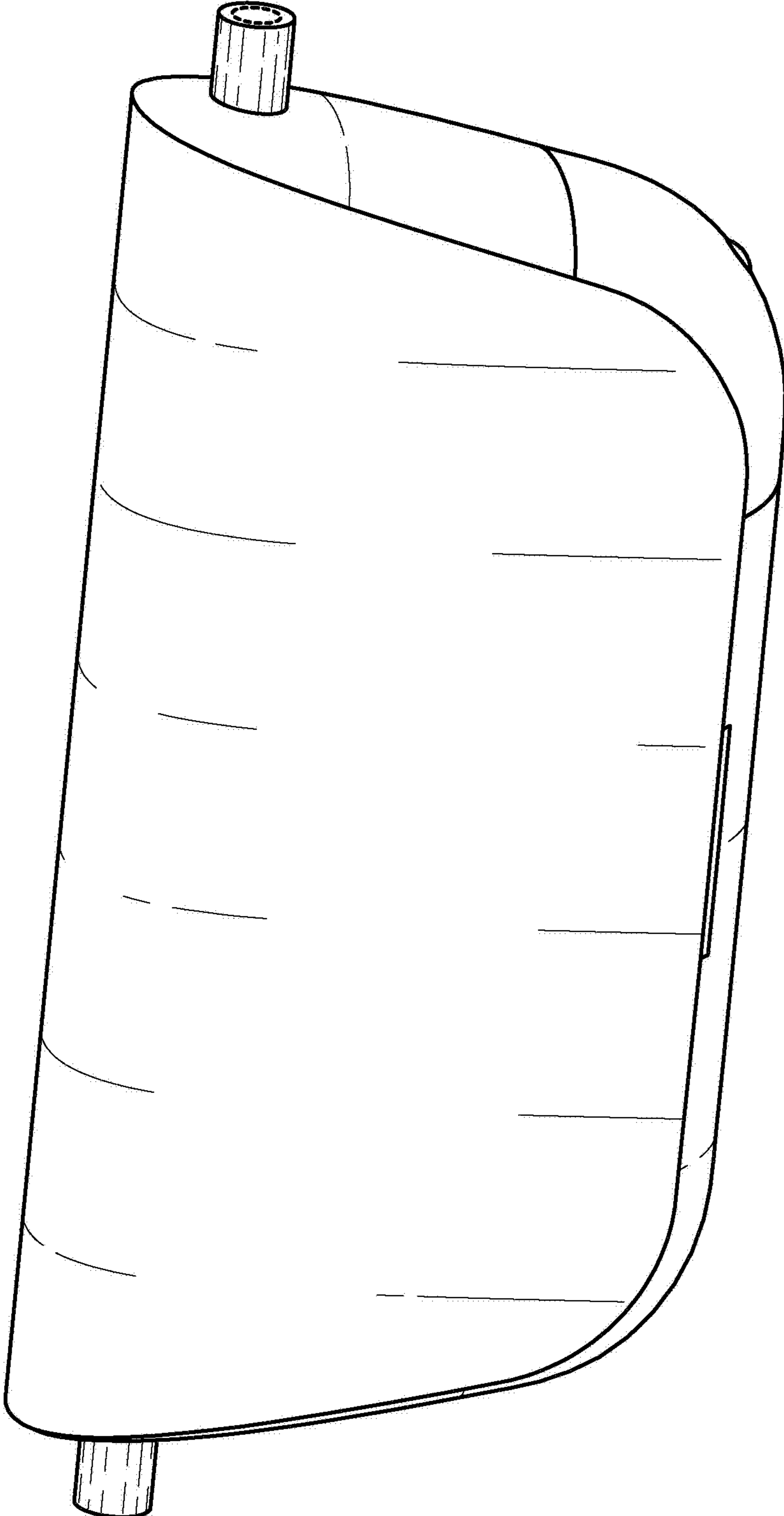

Fig. 7

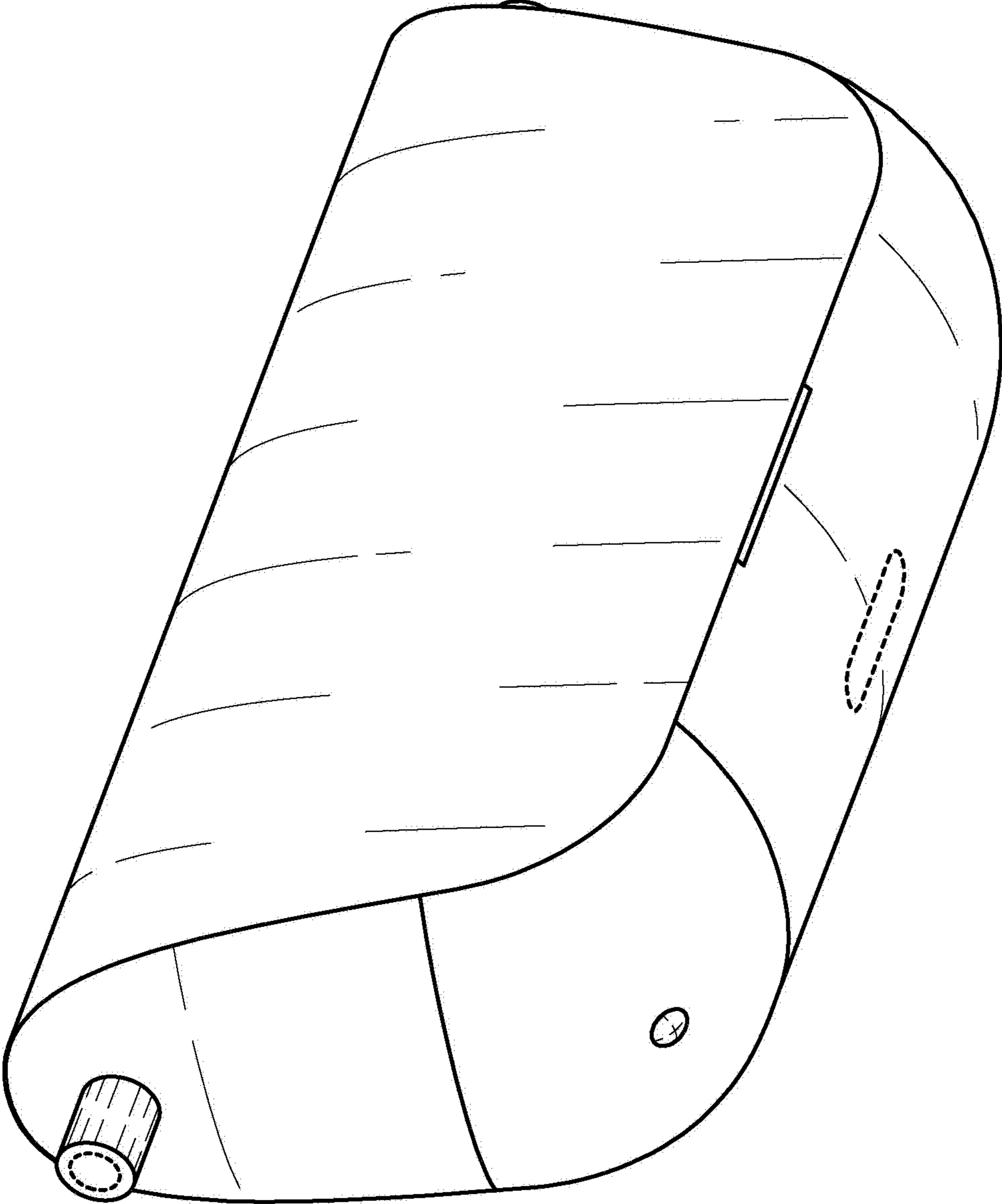

Fig. 8