



US00D962407S

(12) **United States Design Patent** (10) **Patent No.:** **US D962,407 S**
Choi et al. (45) **Date of Patent:** **** Aug. 30, 2022**

(54) **AIR PURIFIER**

(71) Applicant: **Samsung Electronics Co., Ltd.**,
Suwon-si (KR)

(72) Inventors: **Minkyung Choi**, Suwon-si (KR);
Cheolyeon Jo, Suwon-si (KR); **Taehan Kim**,
Suwon-si (KR)

(73) Assignee: **Samsung Electronics Co., Ltd.**,
Suwon-si (KR)

(**) Term: **15 Years**

(21) Appl. No.: **29/750,903**

(22) Filed: **Sep. 17, 2020**

(30) **Foreign Application Priority Data**

Mar. 26, 2020 (KR) 30-2020-0013580

(51) **LOC (13) Cl.** **23-04**

(52) **U.S. Cl.**
USPC **D23/364**

(58) **Field of Classification Search**
 USPC D23/332, 336, 356, 359, 364–366, 378,
D23/499; D14/204, 214, 240, 314, 496
 CPC F24F 1/029; F24F 1/035; F24F 1/0287;
F24F 6/06; F24F 6/14; F24F 13/06; F24F
13/20; F24F 13/222; F24F 3/16; F24F
3/1405; A61L 9/03

See application file for complete search history.

(56) **References Cited**

U.S. PATENT DOCUMENTS

D329,085 S * 9/1992 Lewis D23/365
 D402,361 S * 12/1998 Nepsund D23/355
 D609,701 S * 2/2010 Hou D14/240
 D620,953 S * 8/2010 Andre D14/203.3
 D640,646 S * 6/2011 Wu D14/125
 D649,236 S * 11/2011 Bilko D23/366
 D657,033 S * 4/2012 Chouji D23/351

(Continued)

FOREIGN PATENT DOCUMENTS

CN 2013303622671 12/2013
 CN 302824005 * 5/2014

(Continued)

OTHER PUBLICATIONS

Portable Charger, first available Dec. 5, 2019[online], [site visited
 2022]. Available from internet, URL:< <https://www.amazon.ca/dp/B081SPFH53>> (Year: 2019).*

(Continued)

Primary Examiner — David G Muller

Assistant Examiner — Jamaal Rasheed

(74) *Attorney, Agent, or Firm* — NSIP Law

(57) **CLAIM**

We claim the ornamental design for an air purifier, as shown and described.

DESCRIPTION

FIG. 1 is a front perspective view of an air purifier showing our new design;
 FIG. 2 is a front view thereof;
 FIG. 3 is a rear view thereof;
 FIG. 4 is a left-side view thereof;
 FIG. 5 is a right-side view thereof;
 FIG. 6 is a top view thereof;
 FIG. 7 is a bottom view thereof;
 FIG. 8 is a rear perspective view thereof; and,
 FIG. 9 is an enlarged view of the encircled portion in FIG. 1.

The broken lines in the figures depict portions of the air purifier which form no part of the claimed design.
 The dot-dash broken lines encircling portions of the claimed design that are illustrated in enlargements form no part of the claimed design.

1 Claim, 9 Drawing Sheets

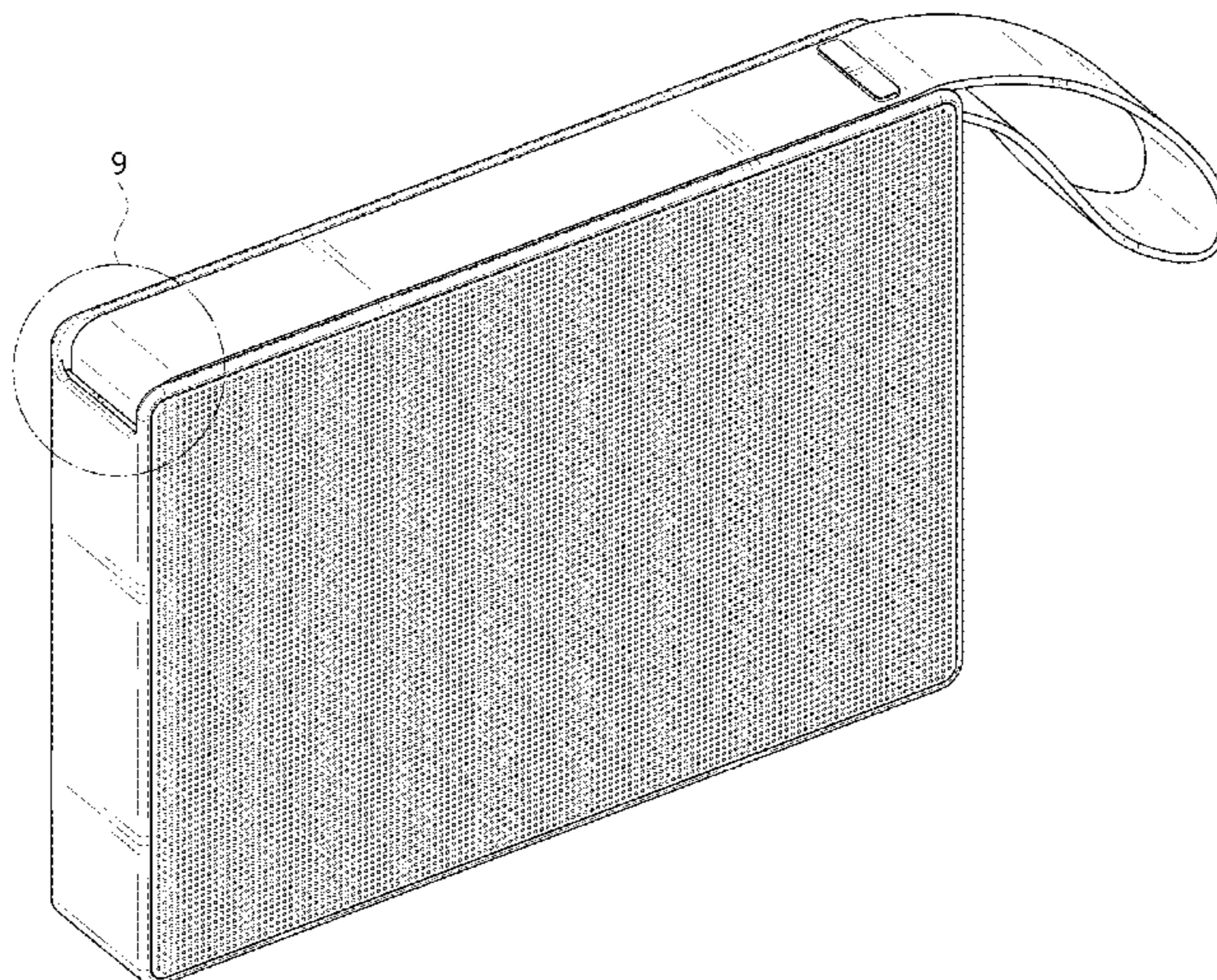

(56)

References Cited

U.S. PATENT DOCUMENTS

D705,782 S * 5/2014 McParland D14/435
 D726,295 S * 4/2015 Kim D23/351
 D727,274 S * 4/2015 Park D14/125
 D728,467 S * 5/2015 Hasbrook D13/103
 D733,278 S * 6/2015 Newlin D23/366
 D734,445 S * 7/2015 Huang D23/364
 D777,725 S * 1/2017 Peng D14/367
 D877,118 S * 3/2020 Wang D14/210
 D890,317 S * 7/2020 Riley D23/366
 D901,661 S * 11/2020 Riegelsberger D23/364
 D914,864 S * 3/2021 Roblin D23/365
 D916,487 S * 4/2021 Zheng D6/518
 D923,005 S * 6/2021 Bi D14/348
 D928,299 S * 8/2021 Chen D23/364
 D935,454 S * 11/2021 Bi D14/348
 D948,490 S * 4/2022 Harley D14/240

FOREIGN PATENT DOCUMENTS

CN 2013306194721 6/2014
 CN 302875468 * 7/2014
 CN 303161018 * 4/2015

CN 303844374 * 9/2016
 CN 2017306417107 5/2018
 KR 30-2011-0001744 4/2012
 KR 30-2015-0066169 7/2016
 KR 30-2017-0012924 12/2017

OTHER PUBLICATIONS

Seagate Portable 5TB External Hard Drive, first available Aug. 6, 2019[online], [site visited Apr. 29, 2022]. Available from internet, URL: < <https://www.amazon.com/dp/B07VS8QCXC?th=1>> (Year: 2019).*

Toshiba Canvio Basics 1TB Portable External Hard Drive, first available Jan. 23, 2018[online], [site visited May 3, 2022]. Available from internet, URL:< <https://www.amazon.com/Toshiba-HDTB410XK3AA-Canvio-Portable-External/dp/B079D359S6?th=1>> (Year: 2018).*

Allergybuyersclub. “QuietPure Mobile by Aerus Portable Air Purifier” [2016] www.youtube.com May 31, 2016 <https://www.youtube.com/watch?v=5qo6ywmHUNk&feature=emb_logo>.

LG Electronics Press Release. “Launched portable air purifier ‘FuryCare Mini’” [2019] www.live.lge.co.kr Mar. 20, 2019 <https://live.lge.co.kr/lg_puricare_mini_0320/>.

* cited by examiner

FIG. 1

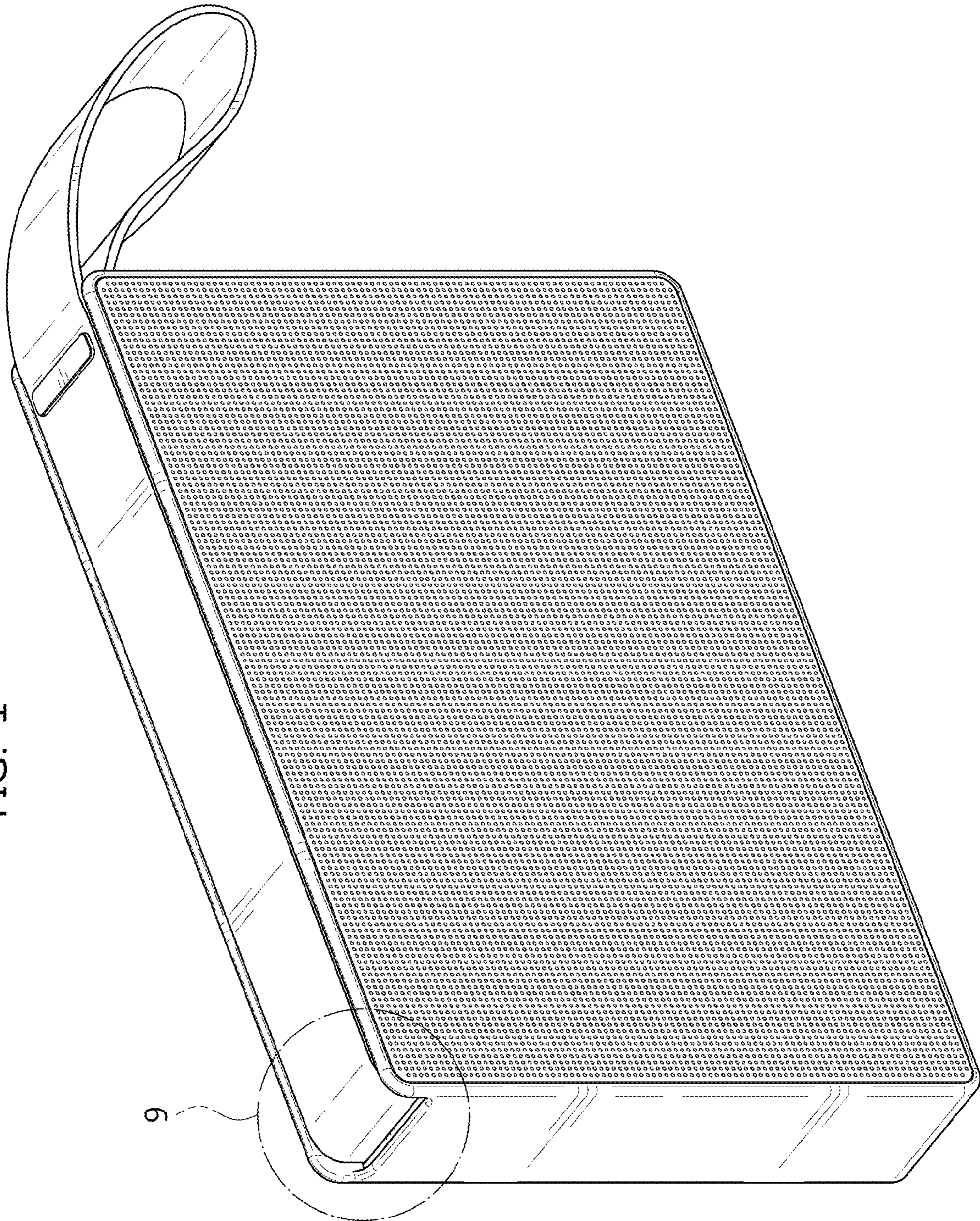

FIG. 2

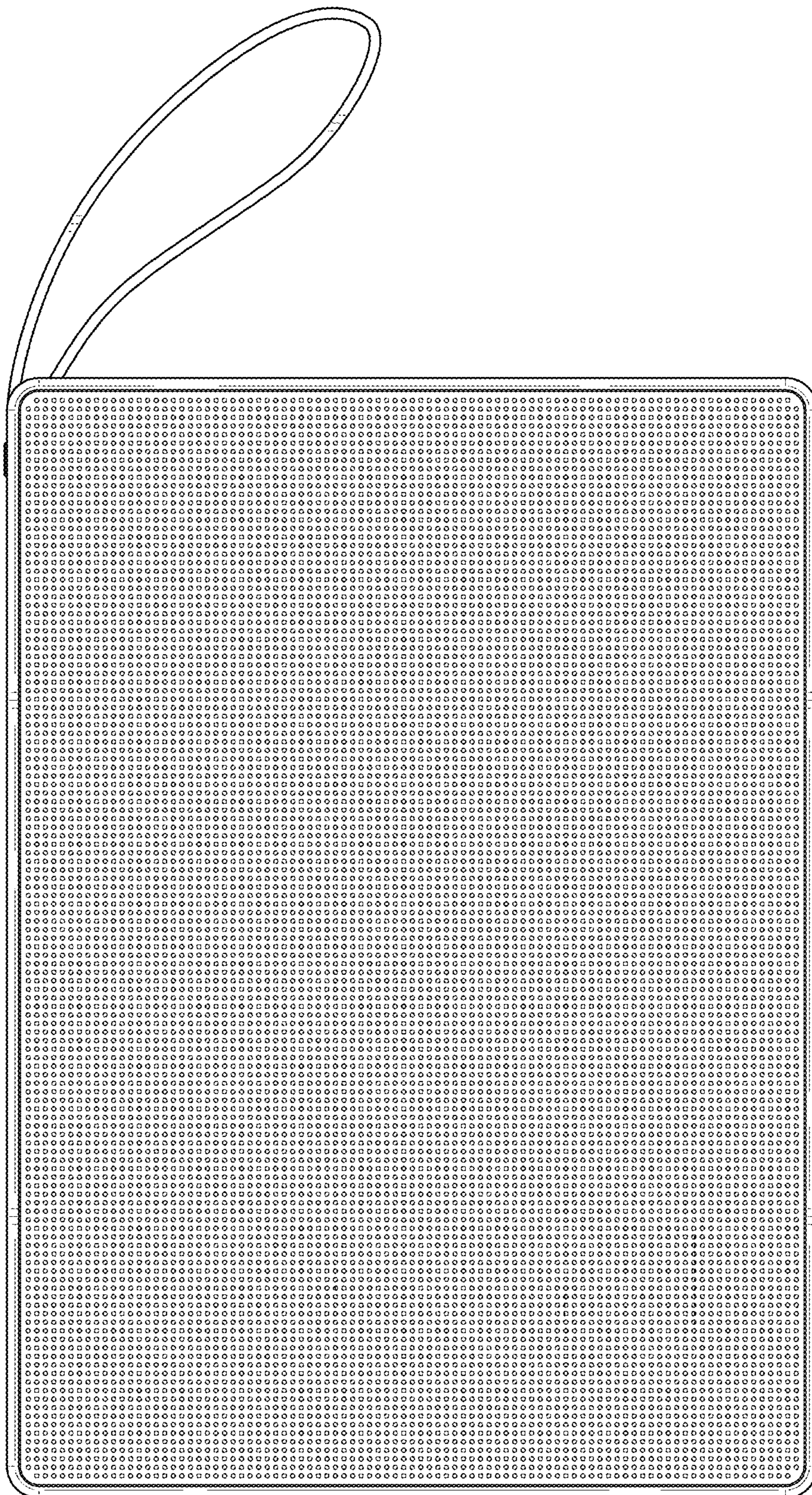

FIG. 3

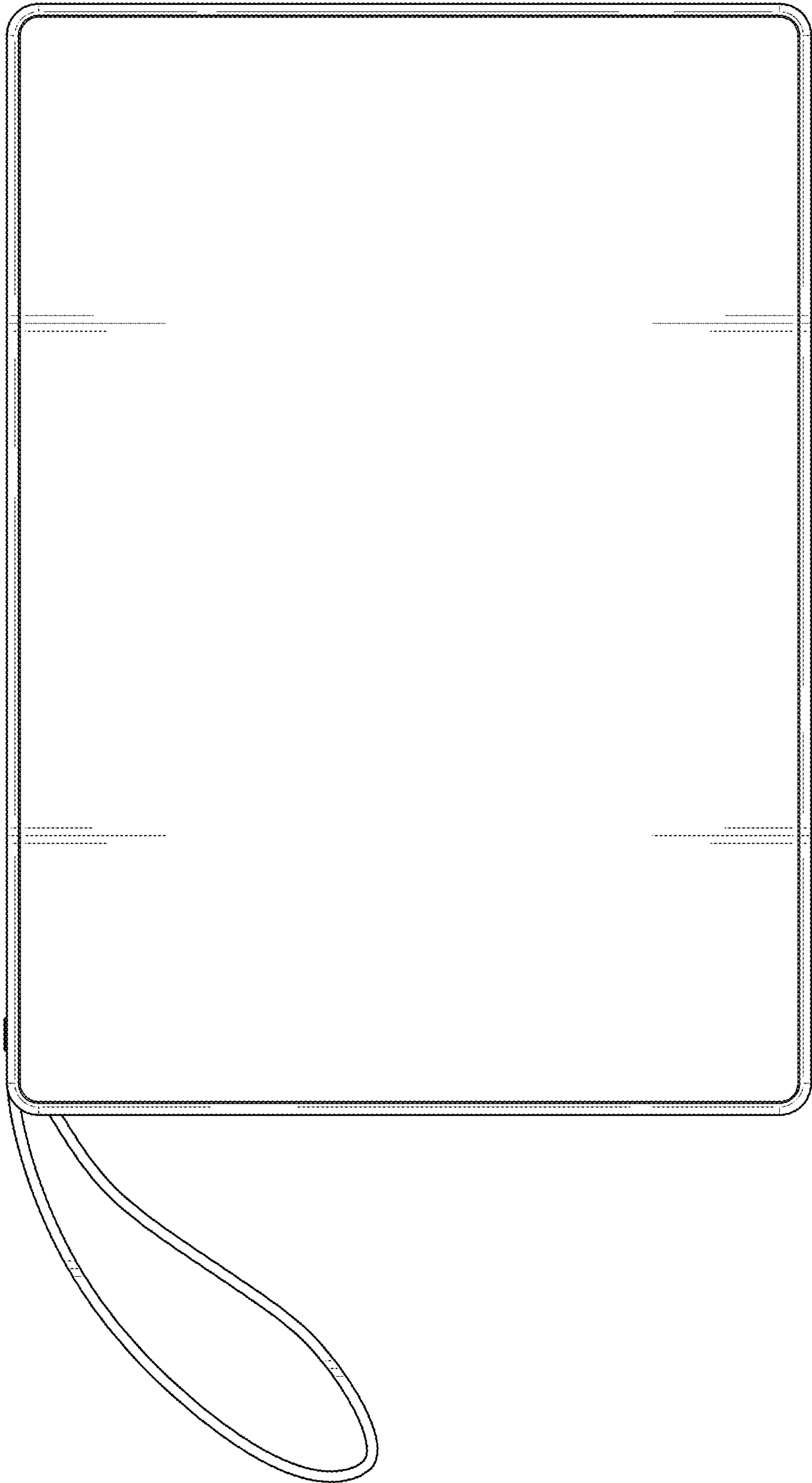

FIG. 4



FIG. 5

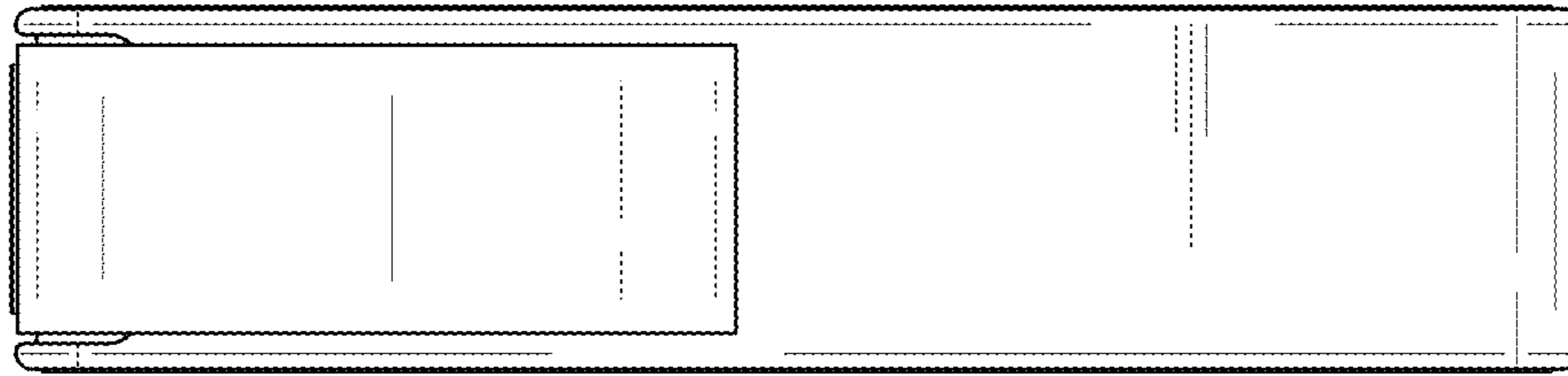

FIG. 6

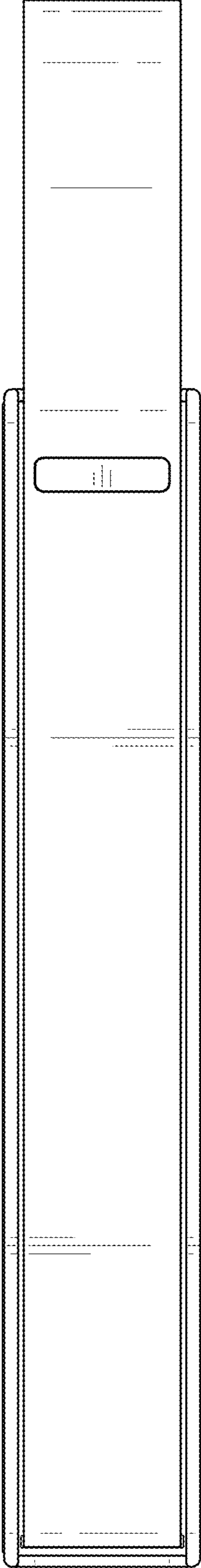

FIG. 7

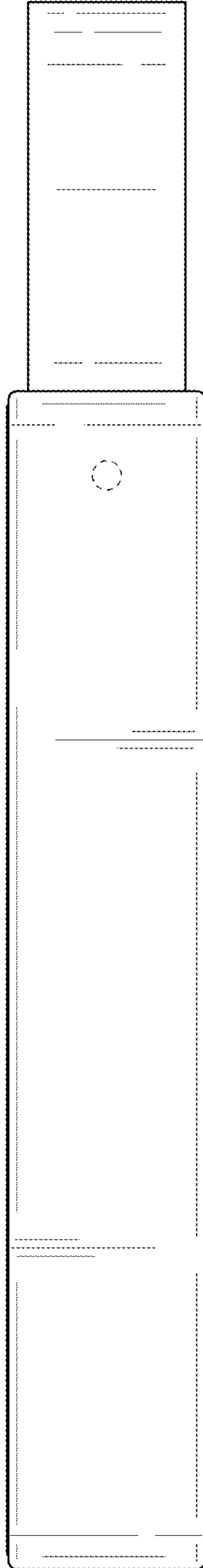

FIG. 8

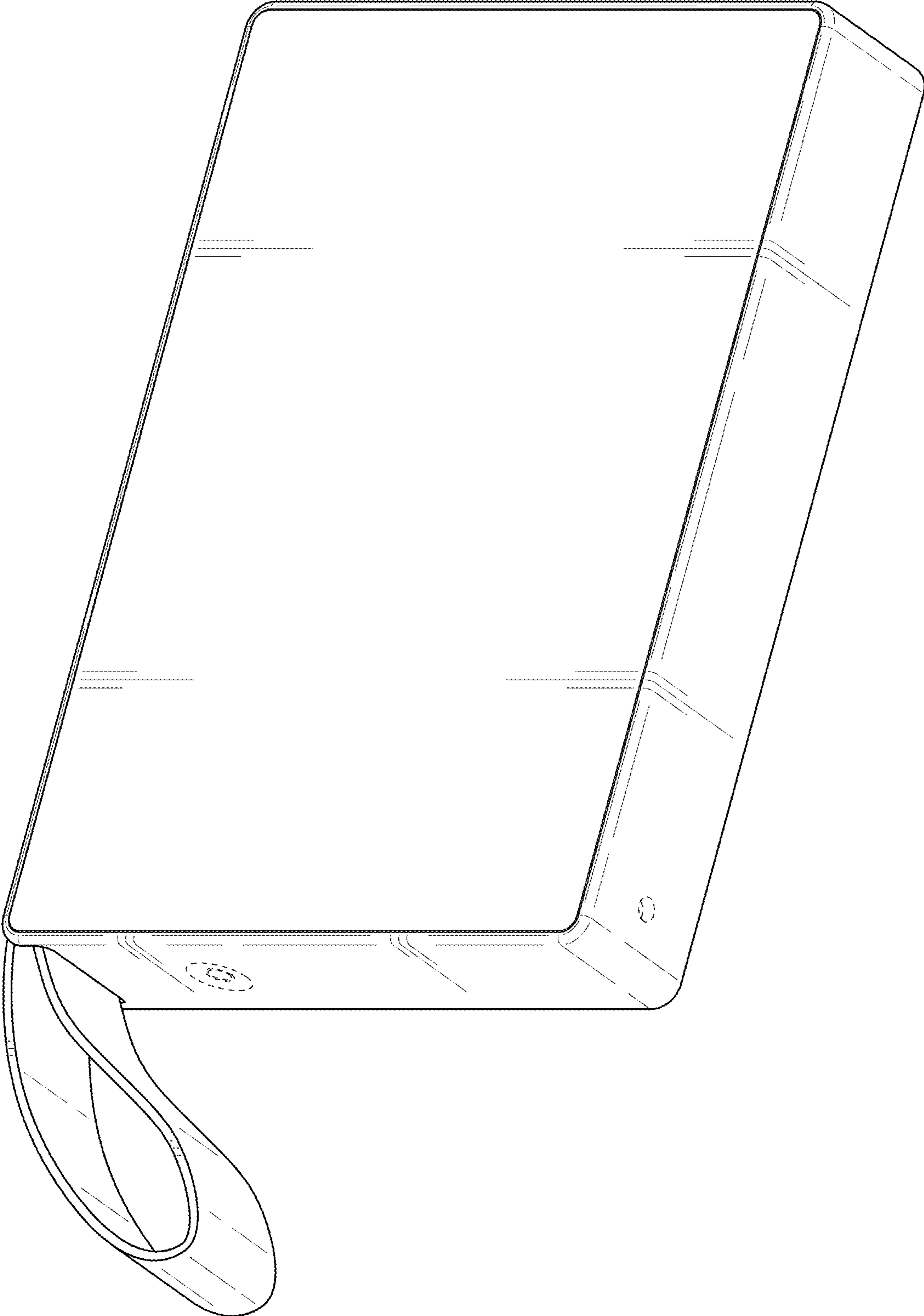

FIG. 9

