



US00D962390S

(12) **United States Design Patent** (10) **Patent No.:** **US D962,390 S**
Svendsen et al. (45) **Date of Patent:** **** *Aug. 30, 2022**

(54) **NOZZLE**
(71) Applicant: **Melnor, Inc.**, Winchester, VA (US)
(72) Inventors: **Sean Svendsen**, Columbus, OH (US);
Donald Collins Meves, Columbus, OH (US); **Eric James Fickas**, Plain City, OH (US)
(73) Assignee: **Melnor, Inc.**, Winchester, VA (US)

D314,609 S 2/1991 Liaw
D325,620 S 4/1992 Heren
D338,706 S 8/1993 Wang
D340,762 S 10/1993 Wang
D355,953 S 2/1995 Wang
D358,450 S 5/1995 Casey
D359,101 S 6/1995 Kuo
D369,853 S 5/1996 Wang
D370,713 S 6/1996 Guo

(Continued)

(*) Notice: This patent is subject to a terminal disclaimer.

JP 3210048 U 4/2017

(**) Term: **15 Years**

FOREIGN PATENT DOCUMENTS

(21) Appl. No.: **29/786,534**

(22) Filed: **Jun. 1, 2021**

OTHER PUBLICATIONS

Office Action dated Mar. 11, 2021, for corresponding U.S. Appl. No. 29/718,904.

Primary Examiner — Kevin K Rudzinski

(74) *Attorney, Agent, or Firm* — HEA Law PLLC; Darrin A. Auito

Related U.S. Application Data

(62) Division of application No. 29/718,904, filed on Dec. 30, 2019, now Pat. No. Des. 923,747, which is a division of application No. 29/670,359, filed on Nov. 15, 2018, now Pat. No. Des. 875,214, which is a division of application No. 29/598,127, filed on Mar. 23, 2017, now Pat. No. Des. 839,384.

(57) **CLAIM**

The ornamental design for a nozzle, as shown and described.

(51) **LOC (13) Cl.** **23-01**

(52) **U.S. Cl.**
USPC **D23/223**

(58) **Field of Classification Search**
USPC D23/226, 213, 223
CPC B05B 9/01; B05B 1/12
See application file for complete search history.

DESCRIPTION

FIG. 1 is a rear perspective view of a second embodiment of a nozzle, showing our new design;
FIG. 2 is a front elevational view thereof;
FIG. 3 is a rear elevational view thereof;
FIG. 4 is a right side elevational view thereof;
FIG. 5 is a left side elevational view thereof;
FIG. 6 is a top plan view thereof;
FIG. 7 is a bottom plan view thereof; and,
FIG. 8 is a front perspective view thereof.

The broken line showing of portions of the nozzle is for the purpose of illustrating environmental structure and forms no part of the claimed design. The dot-dash broken lines are boundary lines and form no part of the claimed design.

(56) **References Cited**

U.S. PATENT DOCUMENTS

2,376,881 A 5/1945 Nielsen
3,150,829 A 9/1964 Specht et al.
3,820,716 A 6/1974 Bauer
4,903,897 A 2/1990 Hayes

1 Claim, 5 Drawing Sheets

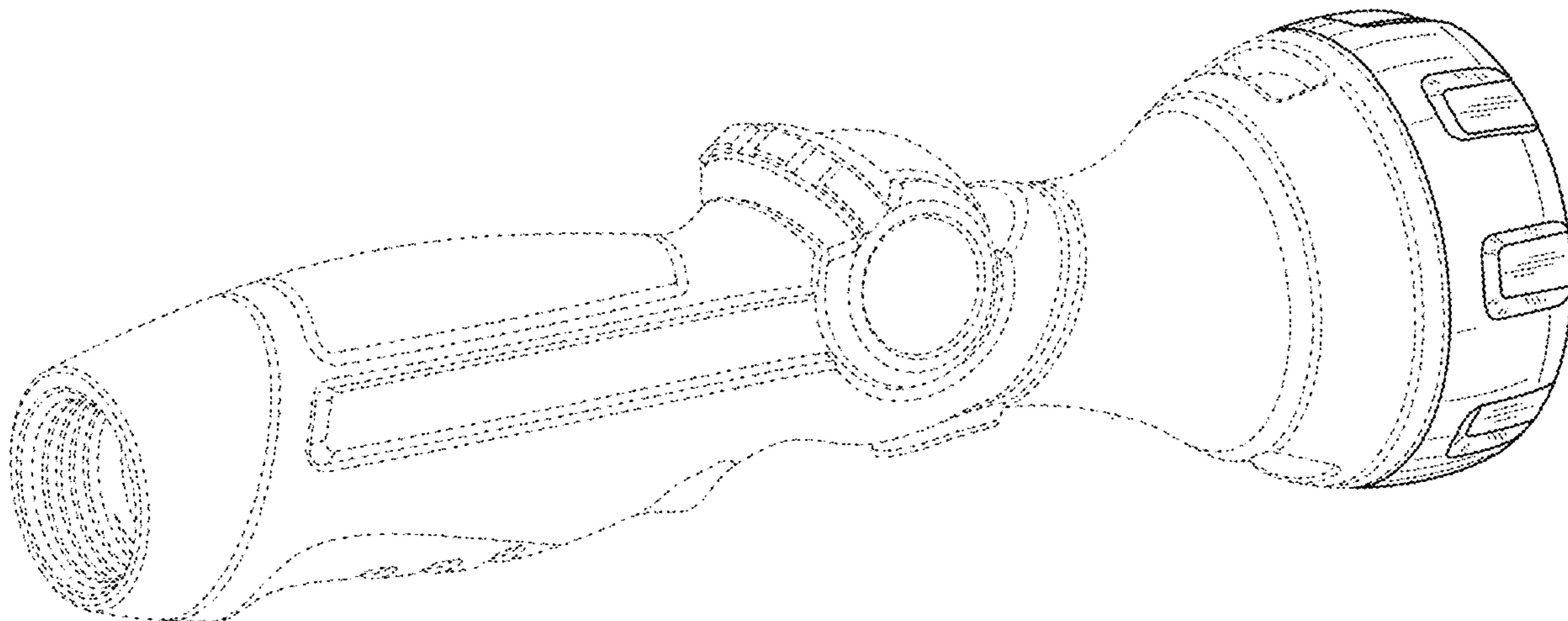

(56)

References Cited

U.S. PATENT DOCUMENTS

D372,297 S	7/1996	Wang		D650,043 S	12/2011	Nies et al.	
D373,813 S	9/1996	Guo		D650,044 S	12/2011	Nies et al.	
D373,814 S	9/1996	Wang		D650,045 S	12/2011	Nies et al.	
D387,128 S	12/1997	Wang		D677,362 S	3/2013	Christopher	
D391,627 S *	3/1998	Goodin D23/226	D678,980 S	3/2013	Nies et al.	
D392,719 S *	3/1998	Guo D23/223	D681,777 S	5/2013	Nies et al.	
5,806,770 A	9/1998	Wang		D681,778 S	5/2013	Nies et al.	
D408,496 S	4/1999	Wang		8,496,190 B2	7/2013	Chen	
D408,497 S	4/1999	Wang		D694,360 S	11/2013	Gaetano	
D408,890 S	4/1999	Wang		D702,319 S	4/2014	Mammen	
D409,720 S	5/1999	Guo		D704,801 S	5/2014	Chen	
D415,557 S	10/1999	Kuo		D705,898 S	5/2014	Chen	
D417,256 S	11/1999	Kuo		D714,423 S	9/2014	Mammen et al.	
D422,054 S	3/2000	Hsin-Fa		D714,908 S	10/2014	Mammen et al.	
D422,339 S	4/2000	Ericksen		D726,872 S	4/2015	Thurgood et al.	
D426,285 S *	6/2000	Heren D23/226	9,073,075 B2	7/2015	Chen	
D431,069 S	9/2000	Heren		D736,349 S	8/2015	Wojan	
D431,280 S	9/2000	Kuo		D736,350 S	8/2015	Cheng	
D446,282 S	8/2001	Wang		D746,945 S	1/2016	Näslund	
D446,283 S	8/2001	Wang		D746,946 S	1/2016	Näslund	
D447,217 S	8/2001	Jacobs et al.		D746,947 S	1/2016	Näslund	
D447,539 S	9/2001	Tse		D748,758 S	2/2016	Duong et al.	
D447,790 S	9/2001	Heren et al.		D749,696 S	2/2016	Thurgood et al.	
D451,981 S	12/2001	Ericksen		9,427,760 B2	8/2016	Chiu	
D451,982 S	12/2001	Chao		D766,400 S	9/2016	Chen	
D454,619 S	3/2002	Wang		D767,091 S	9/2016	Chen	
D461,227 S	8/2002	Guo		D767,094 S	9/2016	Chen	
D467,993 S	12/2002	Chen		D767,096 S	9/2016	Chen	
D468,396 S	1/2003	Chen		D768,817 S	10/2016	Chen	
D468,802 S	1/2003	Nien		D769,415 S	10/2016	Chen	
D475,122 S	5/2003	Kuo		D770,017 S	10/2016	Chen	
D475,435 S	6/2003	Chen		D771,773 S	11/2016	Chen	
D475,762 S	6/2003	Kuo		D771,774 S	11/2016	Chen	
D475,763 S	6/2003	Kuo		D771,775 S	11/2016	Chen	
6,644,625 B1	11/2003	Jacobs et al.		D774,164 S *	12/2016	Chen D23/226
D484,947 S	1/2004	Chen		D779,035 S	2/2017	Chen	
D501,537 S	2/2005	Zeng		D779,036 S	2/2017	Chen	
D502,533 S	3/2005	Chen		D779,040 S	2/2017	Chen	
D517,645 S	3/2006	Chang		D779,041 S	2/2017	Chen	
D522,088 S	5/2006	Roman		D779,634 S	2/2017	Chen	
7,124,965 B1	10/2006	Chen		D780,293 S	2/2017	Chen	
D534,240 S	12/2006	Wang		D780,294 S	2/2017	Chen	
D534,241 S	12/2006	Wang		D782,005 S	3/2017	Näslund et al.	
D548,392 S	8/2007	Lo et al.		D782,007 S	3/2017	Näslund et al.	
7,258,285 B1	8/2007	Combs et al.		D782,008 S	3/2017	Näslund et al.	
D553,712 S	10/2007	Chih		D783,123 S	4/2017	Chen	
D553,713 S	10/2007	Chih		D783,125 S	4/2017	Chen	
D554,231 S	10/2007	Chih		D792,555 S	7/2017	Hung	
D554,233 S	10/2007	Chih		D792,944 S	7/2017	Cheng	
D557,767 S	12/2007	Chih		D792,945 S	7/2017	Cheng	
D557,769 S	12/2007	Chih		D792,947 S	7/2017	Hung	
D558,302 S	12/2007	Chih		D799,001 S	10/2017	Gooden	
D558,858 S	1/2008	Chih		D799,002 S	10/2017	Gooden	
D559,353 S	1/2008	Chih		D799,007 S	10/2017	Cheng	
D559,354 S	1/2008	Chih		D800,254 S	10/2017	Chen	
D559,355 S	1/2008	Chih		D800,255 S	10/2017	Chen	
D564,065 S	3/2008	Yu		D802,092 S	11/2017	Näslund et al.	
D569,478 S	5/2008	Cichy et al.		D820,953 S *	6/2018	Chen D23/223
D584,380 S	1/2009	Cheng		D821,544 S *	6/2018	Urry D23/223
D584,381 S	1/2009	Hung		D824,486 S	7/2018	Urry	
D584,794 S	1/2009	Lo		D824,487 S	7/2018	Montoya et al.	
D585,107 S	1/2009	Lo		D824,488 S	7/2018	Montoya et al.	
D585,108 S	1/2009	Cheng		D824,489 S	7/2018	Montoya et al.	
D585,109 S	1/2009	Cheng		D824,490 S	7/2018	Montoya et al.	
D585,958 S	2/2009	Cheng		D824,491 S	7/2018	Montoya et al.	
D599,433 S	9/2009	Zore		D825,716 S	8/2018	Helmsderfer et al.	
D599,884 S	9/2009	Zore		D838,340 S	1/2019	Svendsen et al.	
D604,389 S	11/2009	Cheng		D838,341 S	1/2019	Svendsen et al.	
D604,390 S	11/2009	Cheng		D838,809 S	1/2019	Svendsen et al.	
D604,395 S	11/2009	Zore		D839,384 S	1/2019	Svendsen et al.	
D605,251 S	12/2009	Zore		D839,992 S	2/2019	Svendsen et al.	
D606,625 S	12/2009	Zore		D846,071 S *	4/2019	Pease D23/213
D606,626 S	12/2009	Zore		D846,074 S	4/2019	Pease et al.	
D614,729 S	4/2010	Cheng		D846,695 S	4/2019	Pease et al.	
D650,042 S	12/2011	Nies et al.		D849,889 S	5/2019	Pease et al.	
				D851,209 S	6/2019	Cheng	
				D875,214 S *	2/2020	Svendsen D23/226
				D876,581 S *	2/2020	Hsieh D23/213
				10,610,879 B2	4/2020	Duong et al.	

(56)

References Cited

U.S. PATENT DOCUMENTS

D900,279 S * 10/2020 Cheng D23/213
 D914,136 S * 3/2021 Chen D23/226
 D914,137 S 3/2021 Chen
 D917,664 S * 4/2021 Chen D23/226
 D917,666 S * 4/2021 Urry D23/226
 D919,750 S * 5/2021 Chen D23/226
 D919,751 S * 5/2021 Chen D23/226
 D919,752 S * 5/2021 Chen D23/226
 D921,156 S * 6/2021 Chen D23/226
 D922,525 S * 6/2021 Urry D23/226
 D923,142 S * 6/2021 Feng D23/226
 D923,747 S * 6/2021 Svendsen D23/223
 D923,750 S * 6/2021 Zheng D23/226
 D924,022 S * 7/2021 Glover D8/2
 D925,002 S * 7/2021 Lin D23/226
 D926,931 S * 8/2021 Chen D23/226

D926,932 S * 8/2021 Chen D23/226
 D928,287 S * 8/2021 Svendsen D23/223
 D928,288 S * 8/2021 Svendsen D23/223
 D929,540 S * 8/2021 Chen D23/226
 D931,413 S * 9/2021 Chen D23/226
 D931,414 S * 9/2021 Chen D23/226
 D934,384 S * 10/2021 Masalin D23/226
 2005/0237742 A1 10/2005 Wang
 2007/0095944 A1 5/2007 Chih
 2008/0245900 A1 10/2008 Chih
 2011/0180636 A1 7/2011 Cheng
 2013/0015271 A1 1/2013 Chen
 2014/0054399 A1* 2/2014 Hsieh B05B 1/3026
 239/526
 2015/0343467 A1* 12/2015 Chen B05B 1/1654
 239/526
 2016/0263593 A1 9/2016 Keim
 2017/0204978 A1* 7/2017 Huang F16K 5/0485
 2018/0161795 A1* 6/2018 Su B05B 1/30

* cited by examiner

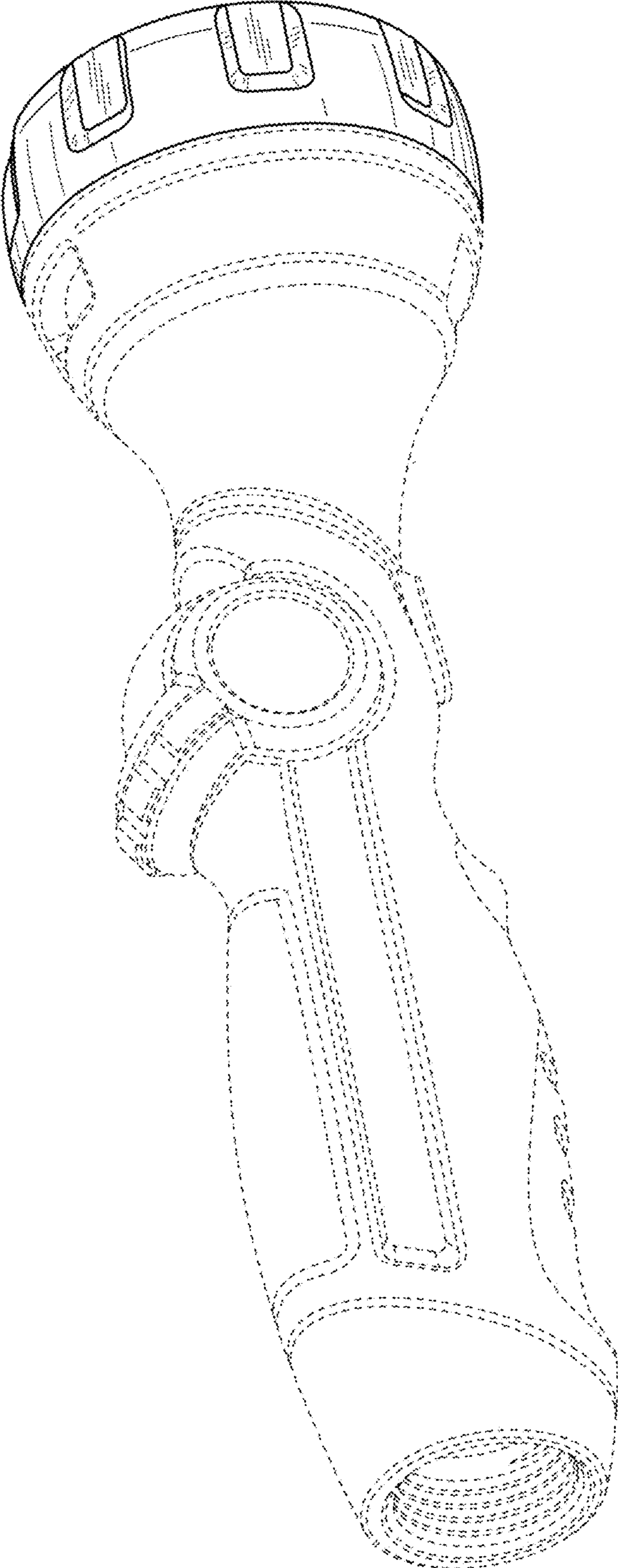

FIG. 1

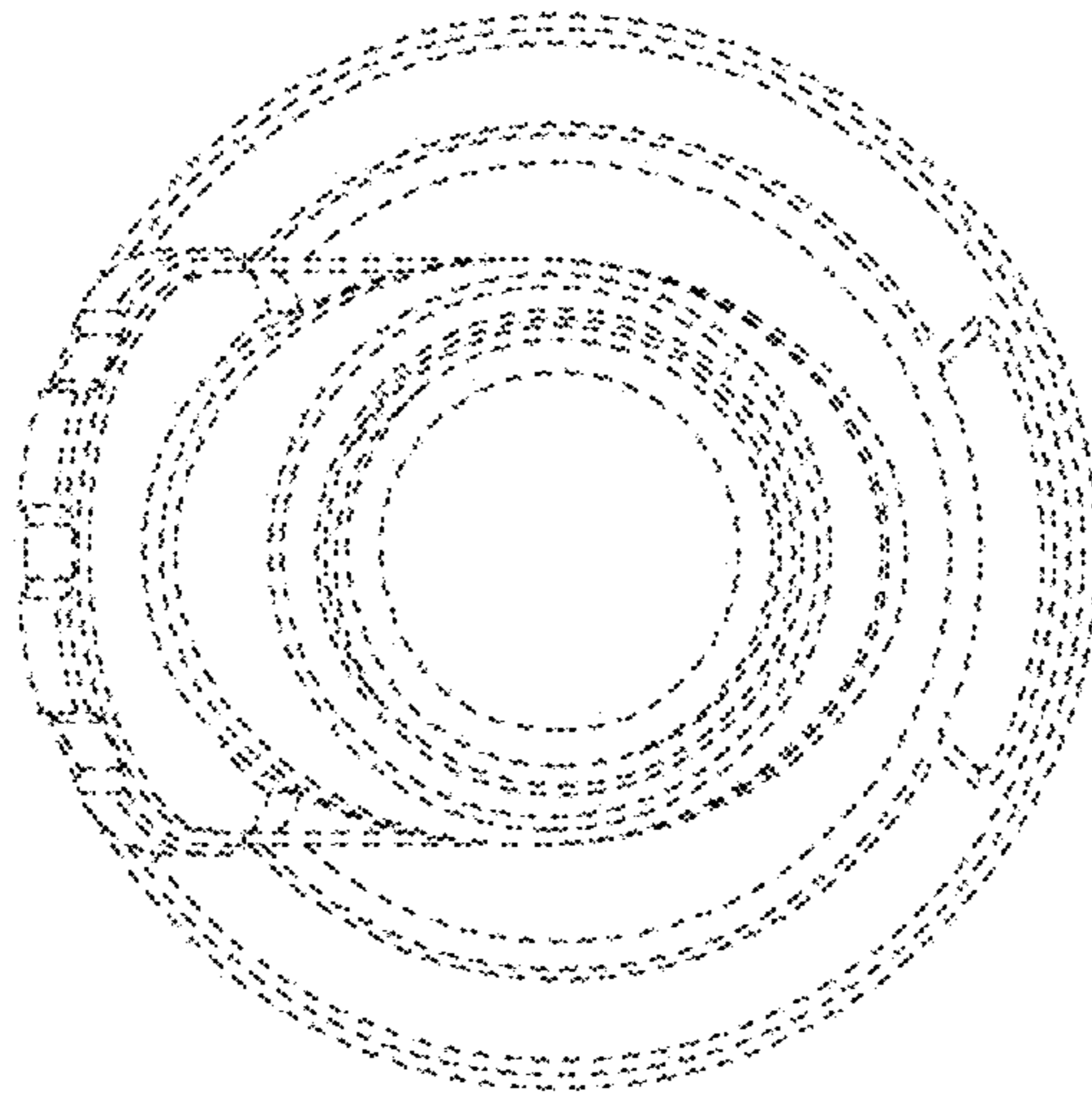

FIG. 3

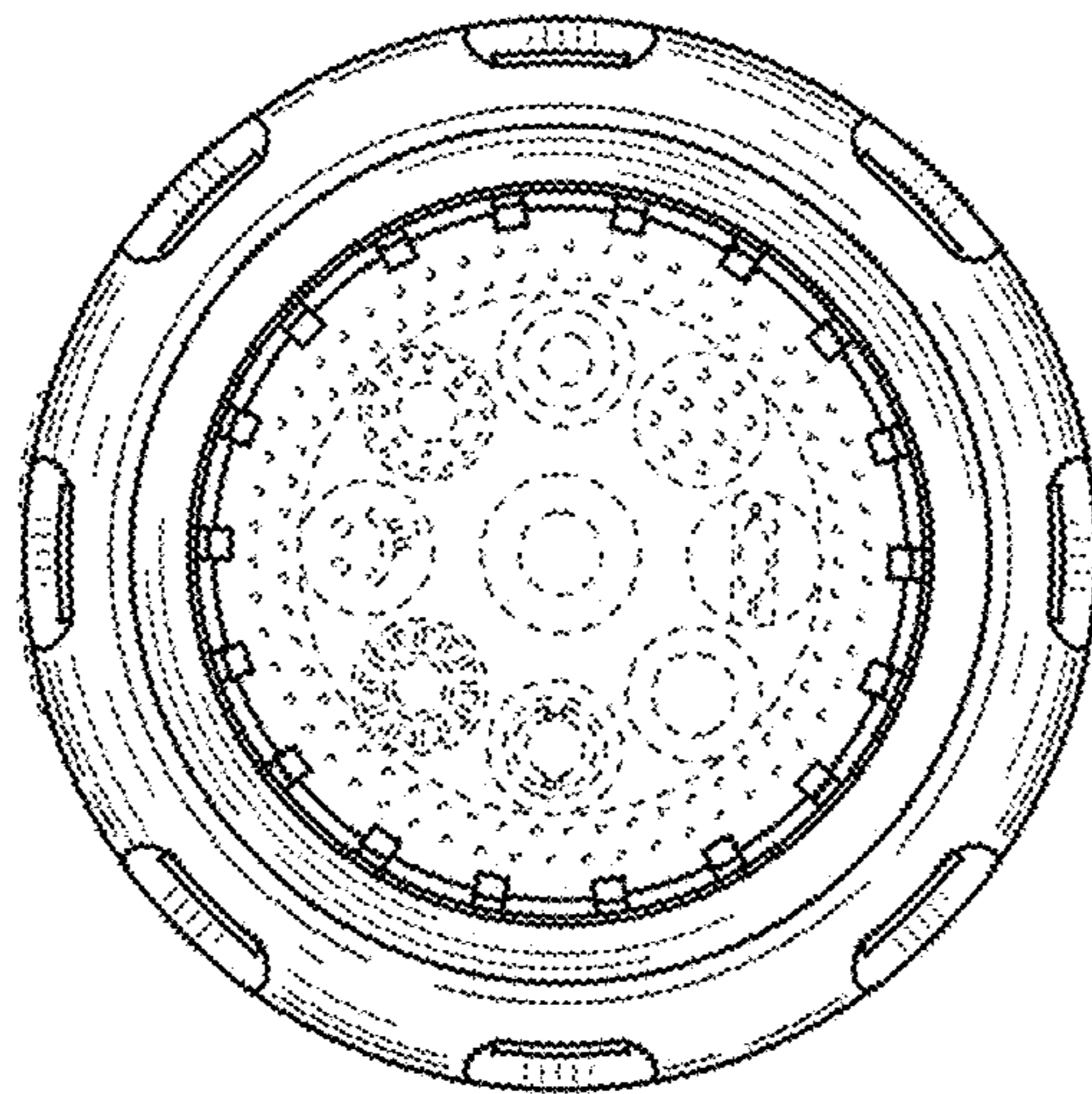

FIG. 2

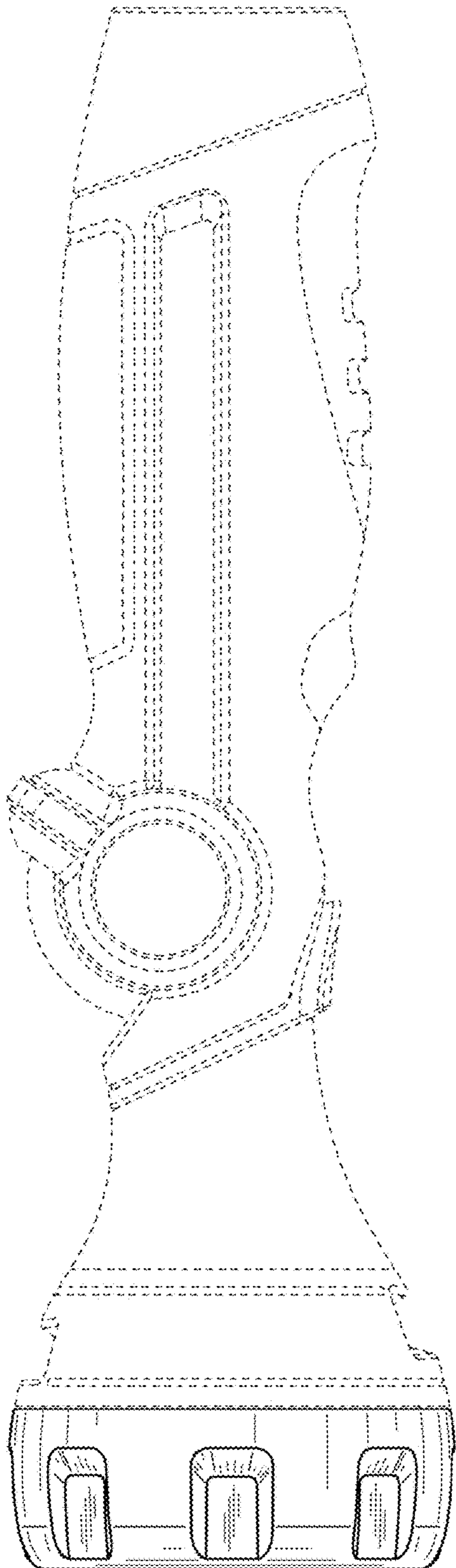

FIG. 4

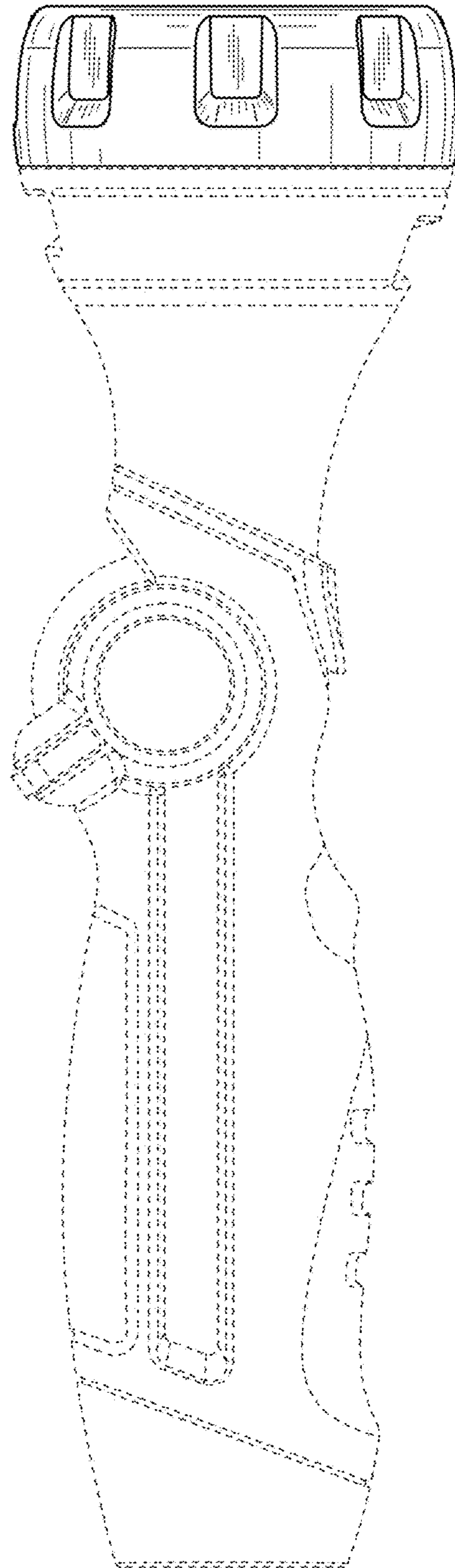

FIG. 5

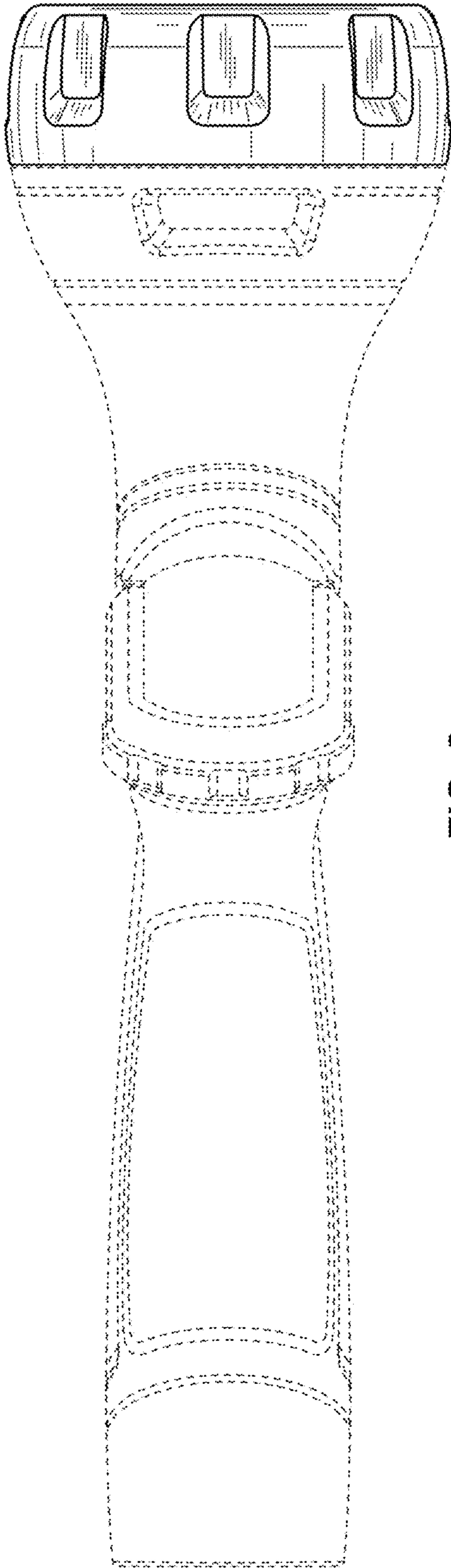

FIG. 6

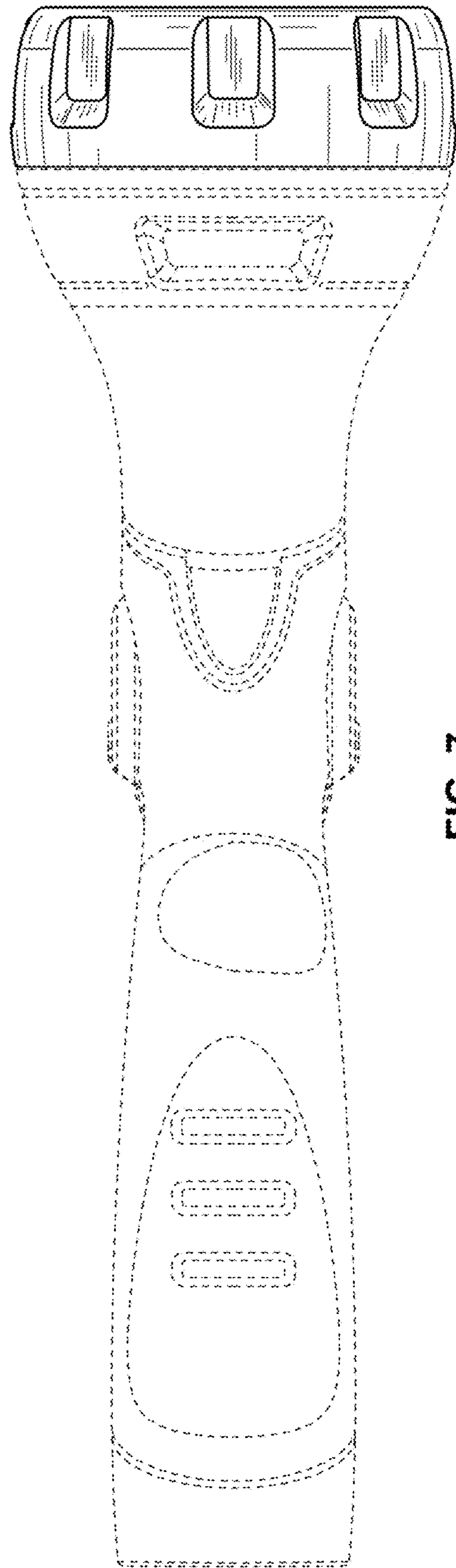

FIG. 7

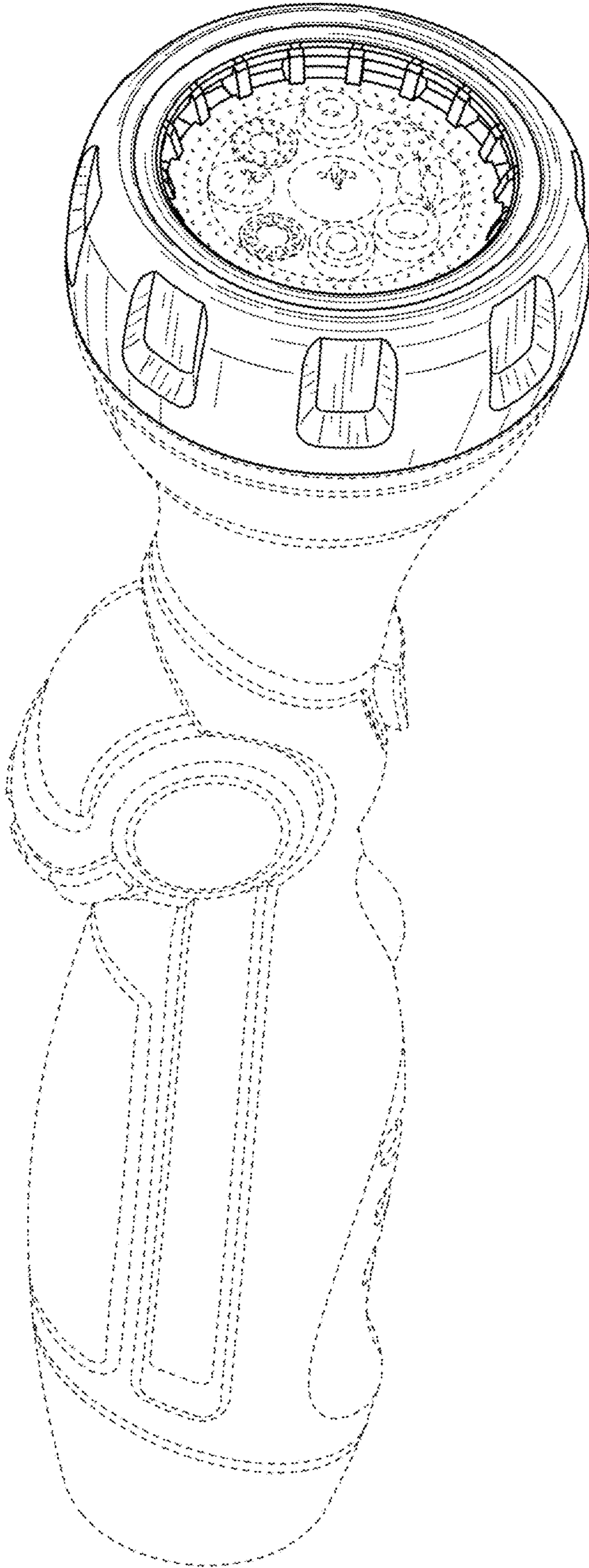

FIG. 8