

US00D962368S

(12) **United States Design Patent** (10) **Patent No.:** **US D962,368 S**  
**Schweigert et al.** (45) **Date of Patent:** **\*\* \*Aug. 30, 2022**

- (54) **GOLF CLUB HEAD**
- (71) Applicant: **PARSONS XTREME GOLF, LLC**,  
Scottsdale, AZ (US)
- (72) Inventors: **Bradley D. Schweigert**, Cave Creek,  
AZ (US); **Michael R. Nicolette**,  
Scottsdale, AZ (US)
- (73) Assignee: **PARSONS XTREME GOLF, LLC**,  
Scottsdale, AZ (US)
- (\*) Notice: This patent is subject to a terminal dis-  
claimer.
- (\*\*) Term: **15 Years**
- (21) Appl. No.: **29/796,666**
- (22) Filed: **Jun. 25, 2021**

D248,783 S	8/1978	Long	
D281,092 S	10/1985	Mills	
4,754,977 A	7/1988	Sahm	
4,869,507 A	9/1989	Sahm	
D313,451 S	1/1991	Shearer	
D335,317 S	5/1993	Shearer	
D335,692 S	5/1993	Antonious	
D336,757 S	6/1993	Antonious	
D350,582 S	9/1994	Miansian et al.	
5,390,919 A	2/1995	Stubbs et al.	
5,429,366 A	7/1995	McCabe	
D363,101 S	10/1995	Sturm	
D365,864 S	1/1996	Sturm	
5,489,097 A	2/1996	Simmons	
D368,751 S	4/1996	Rife	
D369,393 S	4/1996	Takahashi et al.	
5,571,053 A	11/1996	Lane	
D378,688 S	4/1997	Cameron	
D380,514 S	7/1997	Markley	
D385,609 S	10/1997	Cameron	
5,683,307 A	11/1997	Rife	
D388,143 S	12/1997	Huan-Chiang	
D389,207 S	1/1998	Cameron	
D396,083 S *	7/1998	Sheets .....	D21/742
D398,685 S	9/1998	Masuda	
D399,290 S	10/1998	Sizemore, Jr.	
D399,911 S	10/1998	Nicolette et al.	
D400,610 S *	11/1998	Cameron .....	D21/742
5,839,974 A	11/1998	McAllister	
D405,836 S	2/1999	Nicolette et al.	
D409,701 S	5/1999	Ashcraft et al.	
5,924,938 A	7/1999	Hines	
D422,655 S	4/2000	Hicks	
D426,276 S	6/2000	Besnard et al.	
D428,457 S *	7/2000	Rollinson .....	D21/743
D431,854 S	10/2000	Cameron	
D432,192 S	10/2000	Hicks	
D436,151 S	1/2001	Nicolette et al.	
D437,374 S	2/2001	Cameron	
D441,820 S	5/2001	Nicolette et al.	
D443,668 S	6/2001	Nicolette et al.	
D443,905 S	6/2001	Nicolette et al.	
D444,833 S	7/2001	Wells et al.	
6,264,571 B1	7/2001	Lekavich	
D449,664 S	10/2001	Beebe	
D449,865 S	10/2001	Fife, Jr. et al.	
D450,799 S	11/2001	Nicolette et al.	
D451,973 S	12/2001	Wells et al.	
6,348,014 B1	2/2002	Chiu	
6,354,959 B1	3/2002	Nicolette et al.	
6,394,910 B1	5/2002	McCarthy	
D472,949 S	4/2003	Serrano	
D474,821 S	5/2003	Wells et al.	

**Related U.S. Application Data**

- (63) Continuation of application No. 29/701,164, filed on  
Aug. 8, 2019, now Pat. No. Des. 926,898, which is a  
continuation-in-part of application No. 29/692,725,  
filed on May 28, 2019, now abandoned.
- (51) **LOC (13) Cl.** ..... **21-02**
- (52) **U.S. Cl.**  
USPC ..... **D21/736**
- (58) **Field of Classification Search**  
USPC ..... D21/736-746  
CPC ..... A63B 53/00; A63B 53/04; A63B 53/007;  
A63B 53/065; A63B 53/0487; A63B  
60/00; A63B 60/46  
See application file for complete search history.

**References Cited**

**U.S. PATENT DOCUMENTS**

- 723,534 A \* 3/1903 Knight ..... A63B 53/0487  
473/313
- D57,980 S \* 5/1921 Kraeuter ..... D21/741
- RE19,178 E 5/1934 Spiker
- 4,043,562 A 8/1977 Shillington

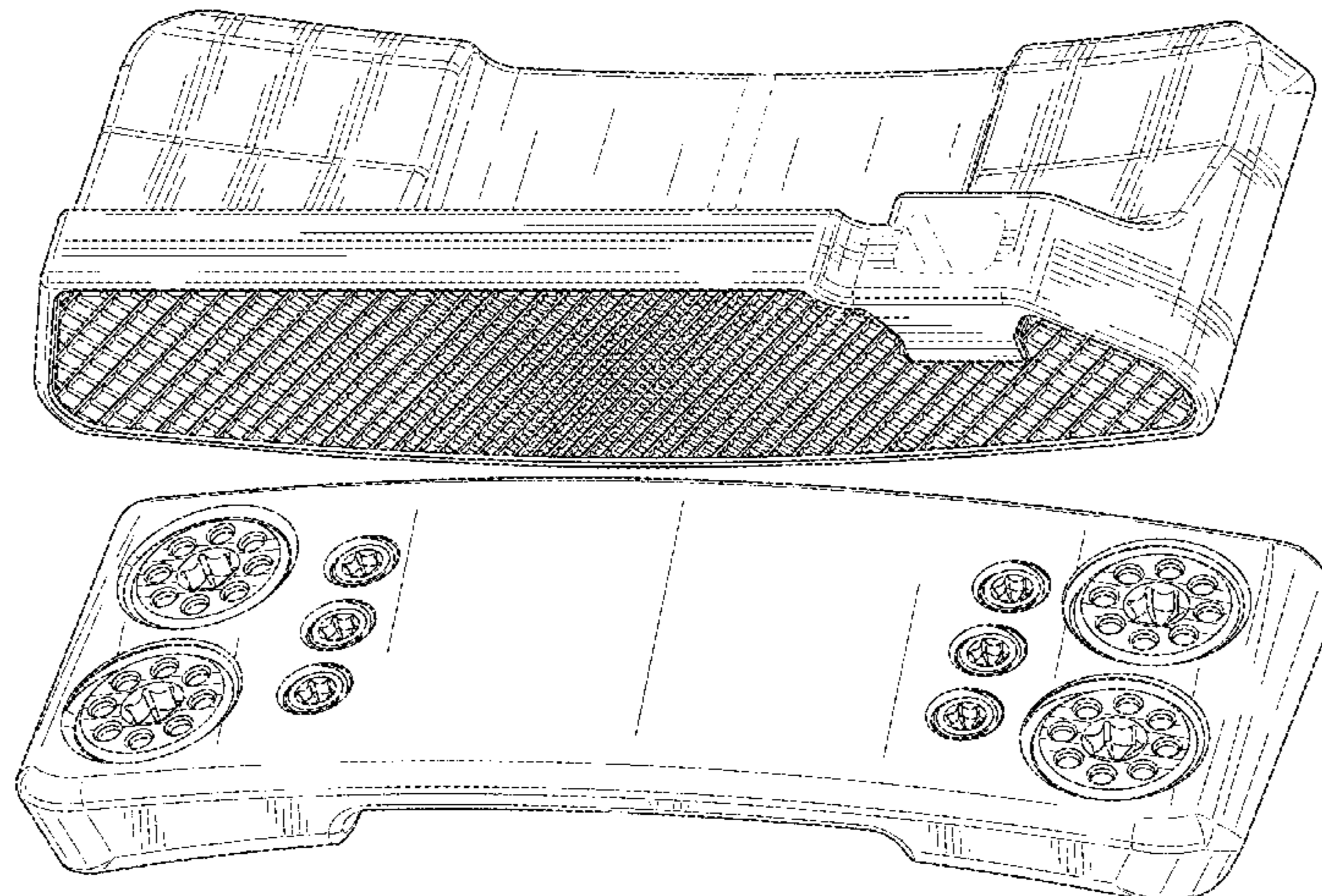



# US D962,368 S

D483,086 S	12/2003	Schweigert et al.		8,721,472 B2	5/2014	Kuan et al.	
D486,872 S	2/2004	Schweigert et al.		8,790,193 B2	7/2014	Serrano et al.	
D496,276 S	9/2004	Smith et al.		D711,483 S	8/2014	Wong	
D500,823 S *	1/2005	Aldrich .....	D21/759	D720,022 S *	12/2014	Rollinson .....	D21/736
6,902,496 B2	6/2005	Solheim et al.		D720,023 S *	12/2014	Rollinson .....	D21/736
D511,801 S	11/2005	Garcia		D720,411 S *	12/2014	Rollinson .....	D21/743
D511,802 S *	11/2005	Cameron .....	D21/744	D720,412 S *	12/2014	Rollinson .....	D21/743
D512,114 S	11/2005	Garcia		D722,350 S	2/2015	Schweigert	
D512,116 S	11/2005	Mirafflor et al.		D722,351 S	2/2015	Parsons et al.	
6,988,956 B2	1/2006	Cover et al.		D722,352 S	2/2015	Nicolette et al.	
D520,088 S	5/2006	Parr		D723,120 S	2/2015	Nicolette	
D531,242 S	10/2006	Adams		D724,164 S	3/2015	Schweigert et al.	
D532,067 S	11/2006	Soracco et al.		D725,208 S *	3/2015	Schweigert .....	D21/743
D532,468 S *	11/2006	Hettinger .....	D21/743	D726,265 S	4/2015	Nicolette	
7,153,220 B2	12/2006	Lo		D726,846 S *	4/2015	Schweigert .....	D21/743
D534,595 S	1/2007	Hasebe		D726,849 S	4/2015	Bums et al.	
7,156,752 B1	1/2007	Bennett		D733,234 S	6/2015	Nicolette	
D536,401 S	2/2007	Kawami		D735,283 S	7/2015	Solheim et al.	
D536,403 S	2/2007	Kawami		D738,447 S *	9/2015	Schweigert .....	D21/736
D538,371 S	3/2007	Kawami		D738,449 S	9/2015	Schweigert	
7,204,765 B2	4/2007	Cover et al.		D739,487 S	9/2015	Schweigert	
D542,869 S	5/2007	Adams		D741,426 S	10/2015	Schweigert	
D543,596 S	5/2007	Rockwood		D746,926 S	1/2016	Parsons et al.	
D543,601 S	5/2007	Kawami		D748,213 S	1/2016	Parsons et al.	
D555,219 S	11/2007	Lin		D748,215 S	1/2016	Parsons et al.	
D556,277 S	11/2007	Broom		9,233,283 B2	1/2016	Schweigert	
D561,854 S	2/2008	Morris		D752,697 S	3/2016	Claveran	
7,331,876 B2	2/2008	Klein		D753,252 S	4/2016	Schweigert	
7,351,162 B2	4/2008	Soracco et al.		D759,173 S *	6/2016	Rollinson .....	D21/743
D569,461 S	5/2008	Morris		D762,274 S *	7/2016	Cardani .....	D21/759
D569,930 S	5/2008	Nehrbas		D763,382 S *	8/2016	Cardani .....	D21/759
7,396,289 B2	7/2008	Soracco et al.		D765,198 S *	8/2016	Cardani .....	D21/759
D577,085 S	9/2008	Nicolette et al.		D768,247 S *	10/2016	Rollinson .....	D21/744
D577,086 S	9/2008	Nicolette et al.		D779,006 S *	2/2017	Abbott .....	D21/744
D579,506 S	10/2008	Nicolette et al.		D791,891 S	7/2017	Davis	
D579,995 S	11/2008	Nicolette et al.		D794,146 S	8/2017	Davis	
D582,497 S	12/2008	Rollinson		D796,603 S *	9/2017	Serrano .....	D21/744
7,473,189 B2	1/2009	Schweigert et al.		D802,073 S *	11/2017	Toulon .....	D21/759
7,491,131 B2	2/2009	Vinton		D812,163 S *	3/2018	Kroloff .....	D21/736
D590,463 S *	4/2009	Hettinger .....	D21/743	D826,353 S *	8/2018	Cameron .....	D21/736
D599,425 S	9/2009	Laub		10,173,105 B2 *	1/2019	Myers .....	A63B 53/0487
D599,867 S	9/2009	Teramoto		D860,353 S *	9/2019	Rollinson .....	D21/743
D600,762 S *	9/2009	Serrano .....	D21/743	10,441,858 B2 *	10/2019	Schweigert .....	A63B 53/065
D600,763 S	9/2009	Cameron		10,478,680 B2 *	11/2019	Schweigert .....	A63B 60/02
D601,214 S	9/2009	Serrano et al.		10,493,331 B2 *	12/2019	Kroloff .....	A63B 53/0433
D603,007 S *	10/2009	Franklin .....	D21/736	D872,816 S *	1/2020	Parsons .....	D21/736
D607,951 S	1/2010	Teramoto		D873,358 S *	1/2020	Lee .....	D21/744
7,744,485 B2	6/2010	Jones et al.		D879,223 S *	3/2020	Serrano .....	D21/742
D620,993 S	8/2010	Laub		D879,895 S *	3/2020	Schweigert .....	D21/759
D623,709 S	9/2010	Serrano et al.		10,646,758 B2 *	5/2020	Schweigert .....	A63B 60/02
D631,925 S	2/2011	Broom		D892,955 S *	8/2020	Clarke .....	D21/744
7,887,432 B2	2/2011	Jones et al.		D893,655 S *	8/2020	Schweigert .....	D21/759
D633,964 S	3/2011	Teramoto		10,737,153 B2 *	8/2020	Schweigert .....	A63B 53/0487
D634,801 S *	3/2011	Rollinson .....	D21/743	D895,747 S *	9/2020	Rollinson .....	D21/743
7,909,707 B2	3/2011	Klein		D896,903 S *	9/2020	Schweigert .....	D21/743
D635,625 S *	4/2011	Rollinson .....	D21/743	D898,846 S *	10/2020	Clarke .....	D21/743
7,918,745 B2	4/2011	Morris et al.		D898,847 S *	10/2020	Clarke .....	D21/743
7,927,226 B1	4/2011	Twitty		D913,388 S *	3/2021	Nicolette .....	D21/736
D638,891 S *	5/2011	Nicolette .....	D21/736	D913,389 S *	3/2021	Schweigert .....	D21/736
D642,643 S	8/2011	Nicolette et al.		10,960,271 B2 *	3/2021	Kroloff .....	A63B 53/0487
D643,485 S	8/2011	Nicolette et al.		10,981,038 B2 *	4/2021	Schweigert .....	A63B 53/0487
D644,703 S *	9/2011	Serrano .....	D21/743	D923,729 S *	6/2021	Nicolette .....	D21/736
D645,104 S	9/2011	Nicolette et al.		D924,345 S *	7/2021	Nicolette .....	D21/736
D648,408 S *	11/2011	Teramoto .....	D21/743	D924,346 S *	7/2021	Nicolette .....	D21/736
8,096,039 B2	1/2012	Soracco et al.		D926,898 S *	8/2021	Schweigert .....	D21/736
D653,718 S	2/2012	Stokke et al.		D927,622 S *	8/2021	Schweigert .....	D21/759
D655,361 S	3/2012	Ramsauer		D928,263 S *	8/2021	Schweigert .....	D21/759
D661,753 S	6/2012	Cameron et al.		11,090,535 B1 *	8/2021	Schweigert .....	A63B 53/065
D661,754 S *	6/2012	Cameron .....	D21/759	11,141,635 B2 *	10/2021	Schweigert .....	A63B 60/02
D666,260 S	8/2012	Cynn		D943,691 S *	2/2022	Serrano .....	D21/736
8,371,958 B2 *	2/2013	Treadwell .....	A63B 53/04 473/331	D945,543 S *	3/2022	Kroloff .....	D21/736
				D949,269 S *	4/2022	Andrews .....	D21/736
				D951,379 S *	5/2022	Andrews .....	D21/736
8,376,878 B2	2/2013	Bennett et al.		2007/0142122 A1	6/2007	Bonneau	
D688,339 S	8/2013	Hilton et al.		2007/0207875 A1	9/2007	Kuan et al.	
D688,341 S	8/2013	Rollinson		2007/0238548 A1	10/2007	Johnson	
D691,226 S	10/2013	Hilton et al.		2008/0139333 A1	6/2008	Klein	
D691,681 S *	10/2013	Hilton .....	D21/736	2008/0146372 A1	6/2008	John	
D699,308 S	2/2014	Rollinson		2008/0176672 A1	7/2008	Roach et al.	
D704,782 S	5/2014	Rollinson					

2011/0165959 A1 7/2011 Klein  
 2013/0165256 A1 6/2013 Stevenson  
 2013/0210537 A1 8/2013 Ainscough et al.  
 2021/0113898 A1\* 4/2021 Kroloff ..... A63B 53/065

FOREIGN PATENT DOCUMENTS

JP 2005160691 A 6/2005

OTHER PUBLICATIONS

Pxg putters google search; google.com; Apr. 29, 2022.\*  
 PXG.com; Apr. 29, 2022.\*  
 PCT/US15/27841: International Search Report and Written Opinion dated Jul. 30, 2015 (14 pages).  
 TourSpecGolf (Gold's Factory Multi Weighted Custom Putter) [online]. Nov. 20, 2010 [retrieved Jul. 7, 2015].  
 U.S. Appl. No. 14/586,720, Parsons et al., "Golf Club Heads and Methods to Manufacture Golf Club Heads," filed Dec. 30, 2014.  
 U.S. Appl. No. 29/523,587, Schweigert, "Golf Club Head," filed Apr. 10, 2015.

\* cited by examiner

*Primary Examiner* — Mitchell I. Siegel

(57) **CLAIM**

The ornamental design for a golf club head, as shown and described.

**DESCRIPTION**

FIG. 1 is a top perspective view of a golf club head according to a first embodiment;  
 FIG. 2 is a bottom perspective view of the golf club head of FIG. 1;  
 FIG. 3 is a front elevational view of the golf club head of FIG. 1;

FIG. 4 is a rear elevational view of the golf club head of FIG. 1;  
 FIG. 5 is a top view of the golf club head of FIG. 1;  
 FIG. 6 is a bottom view of the golf club head of FIG. 1;  
 FIG. 7 is a left side view of the golf club head of FIG. 1;  
 FIG. 8 is a right side view of the golf club head of FIG. 1;  
 FIG. 9 is a top perspective view of a golf club head according to a second embodiment;  
 FIG. 10 is a bottom perspective view of the golf club head of FIG. 9;  
 FIG. 11 is a front elevational view of the golf club head of FIG. 9;  
 FIG. 12 is a rear elevational view of the golf club head of FIG. 9;  
 FIG. 13 is a top view of the golf club head of FIG. 9;  
 FIG. 14 is a bottom view of the golf club head of FIG. 9;  
 FIG. 15 is a left side view of the golf club head of FIG. 9;  
 FIG. 16 is a right side view of the golf club head of FIG. 9;  
 FIG. 17 is a top perspective view of a golf club head according to a third embodiment;  
 FIG. 18 is a bottom perspective view of the golf club head of FIG. 17;  
 FIG. 19 is a front elevational view of the golf club head of FIG. 17;  
 FIG. 20 is a rear elevational view of the golf club head of FIG. 17;  
 FIG. 21 is a top view of the golf club head of FIG. 17;  
 FIG. 22 is a bottom view of the golf club head of FIG. 17;  
 FIG. 23 is a left side view of the golf club head of FIG. 17;  
 and,  
 FIG. 24 is a right side view of the golf club head of FIG. 17.  
 The broken lines shown on the drawings form no part of the claimed design.

**1 Claim, 21 Drawing Sheets**



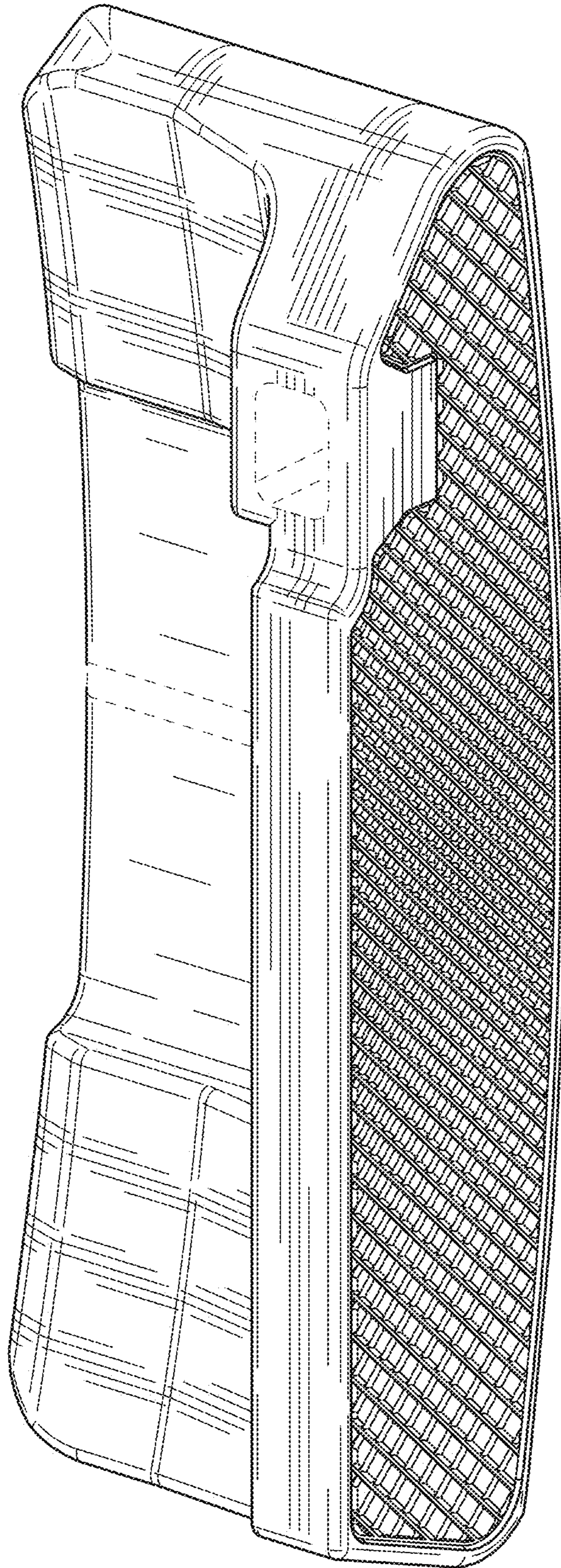

FIG. 1

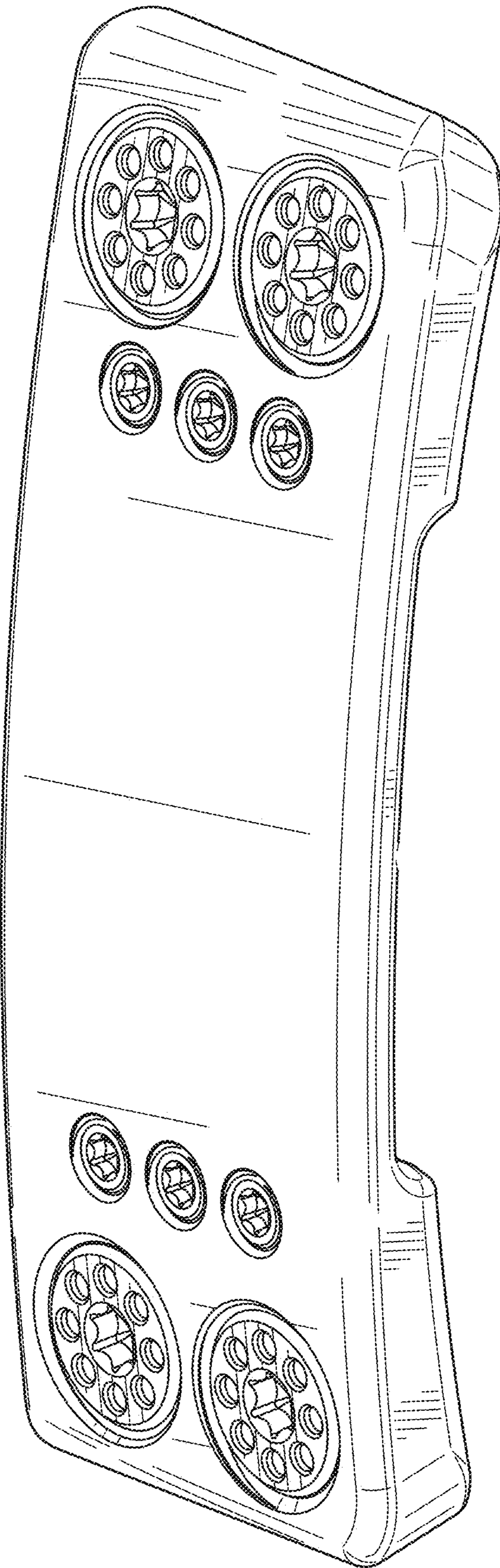

FIG. 2



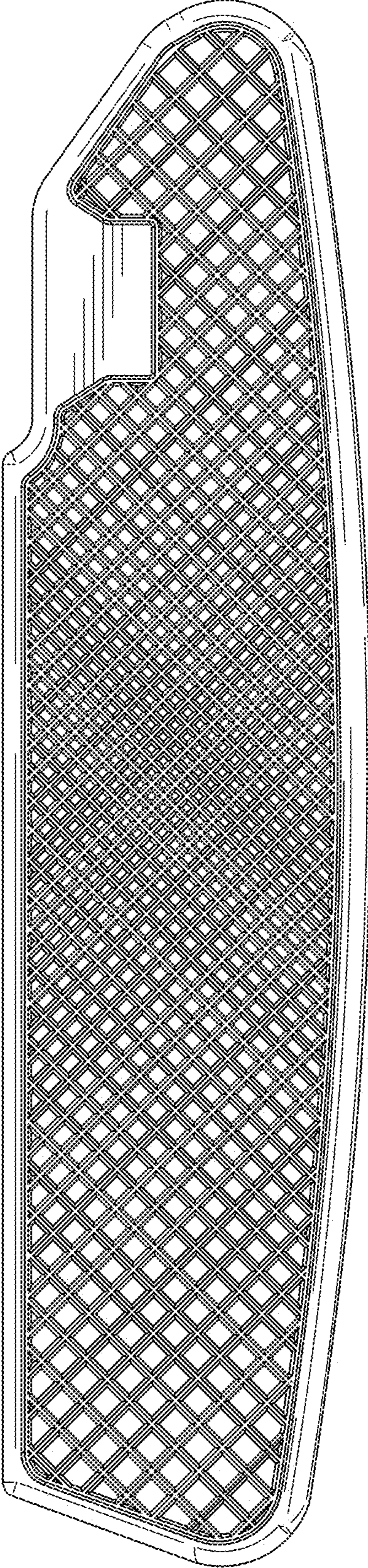

FIG. 3



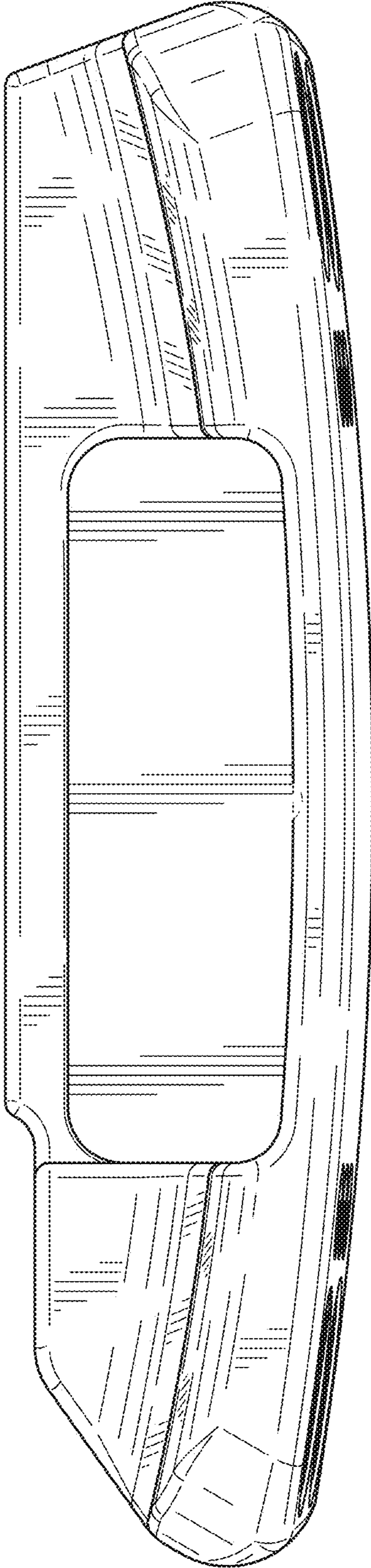

FIG. 4

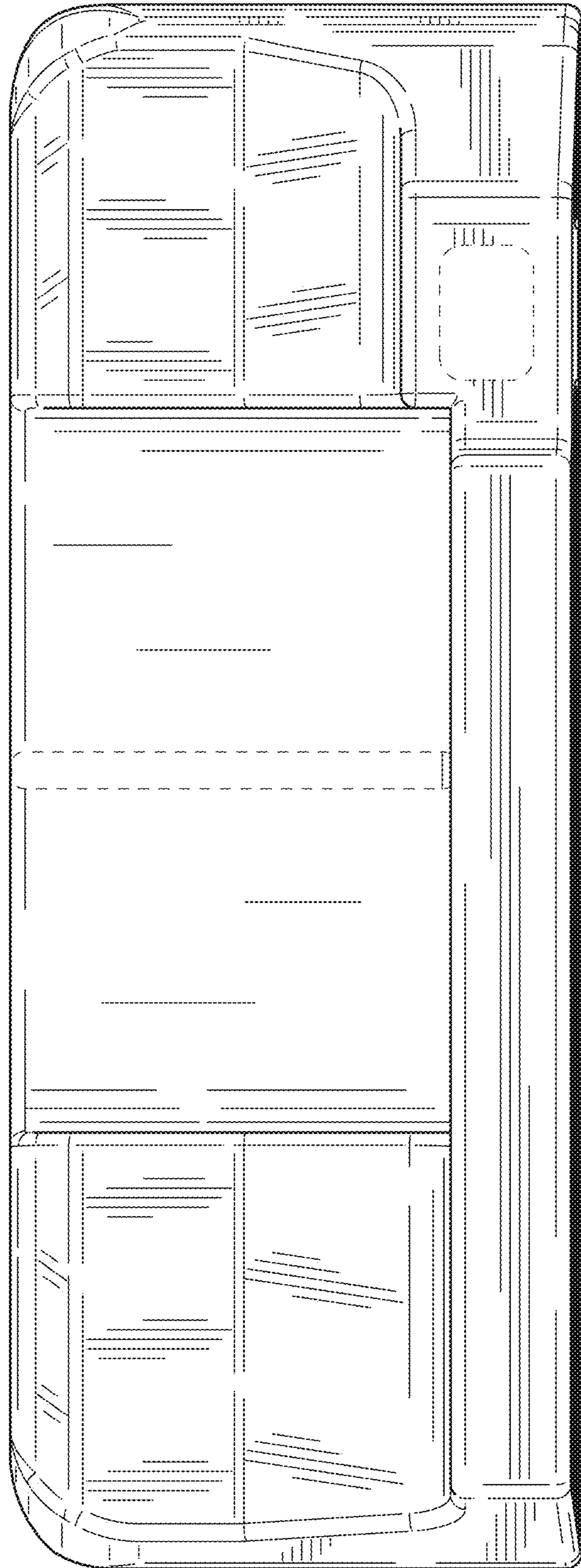

FIG. 5



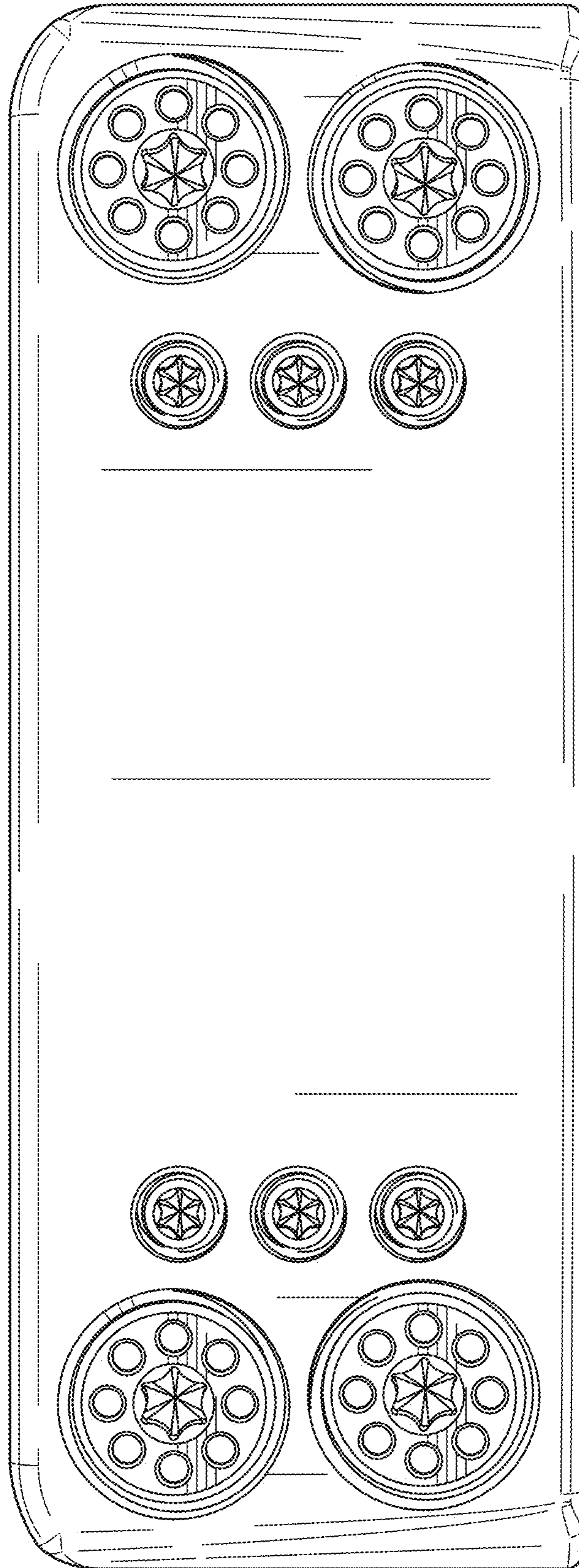

FIG. 6

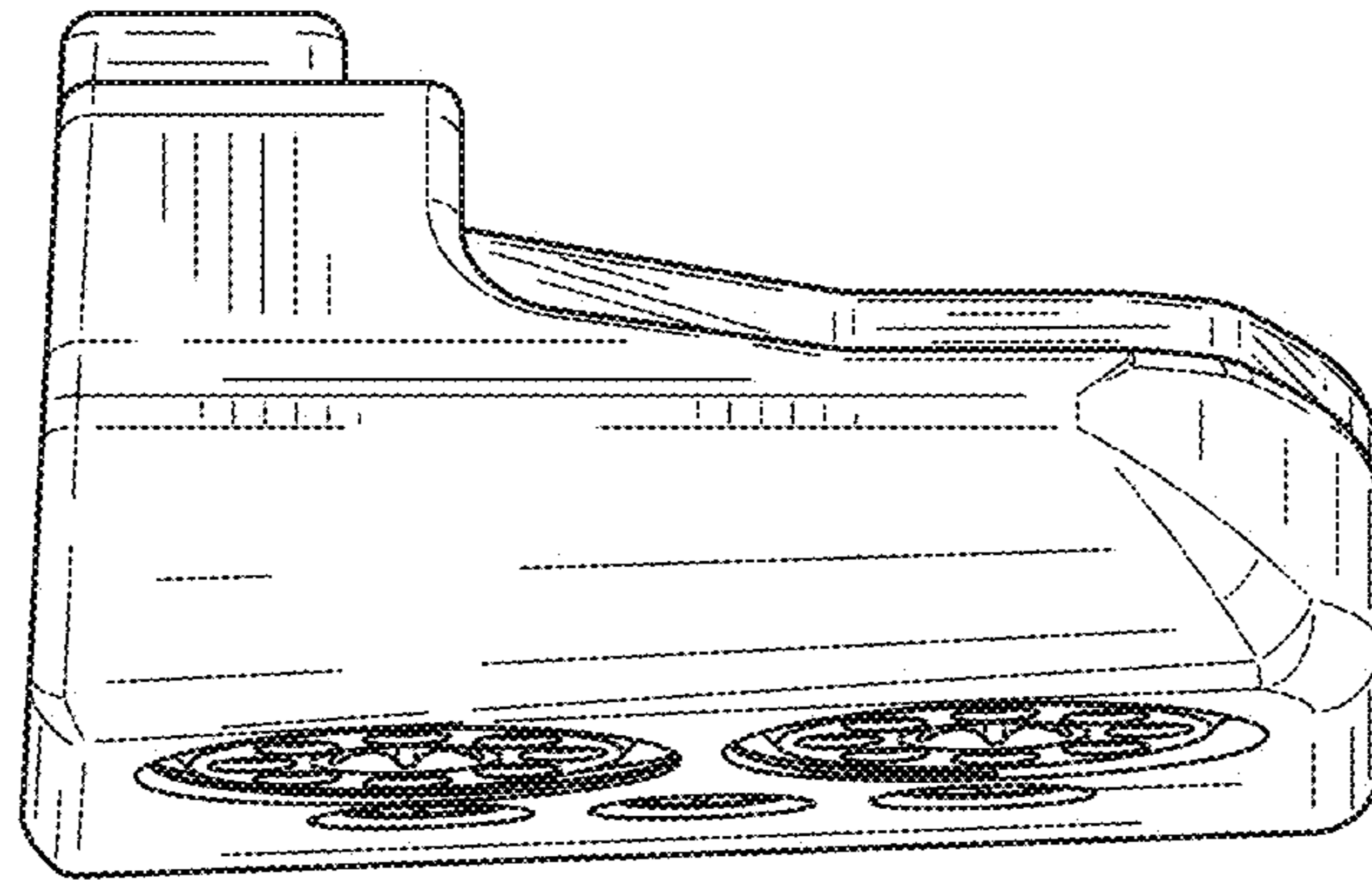

FIG. 7

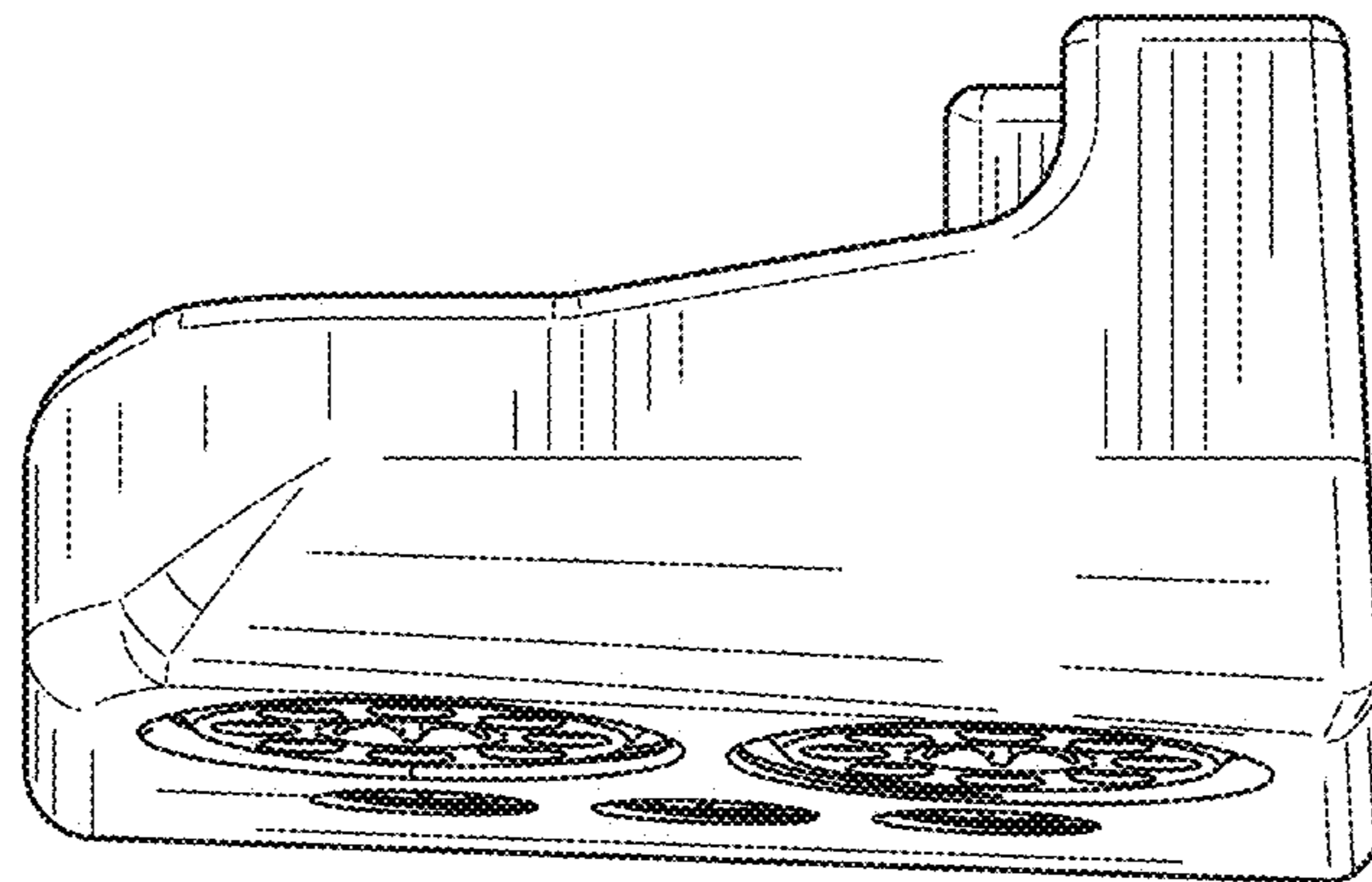

FIG. 8



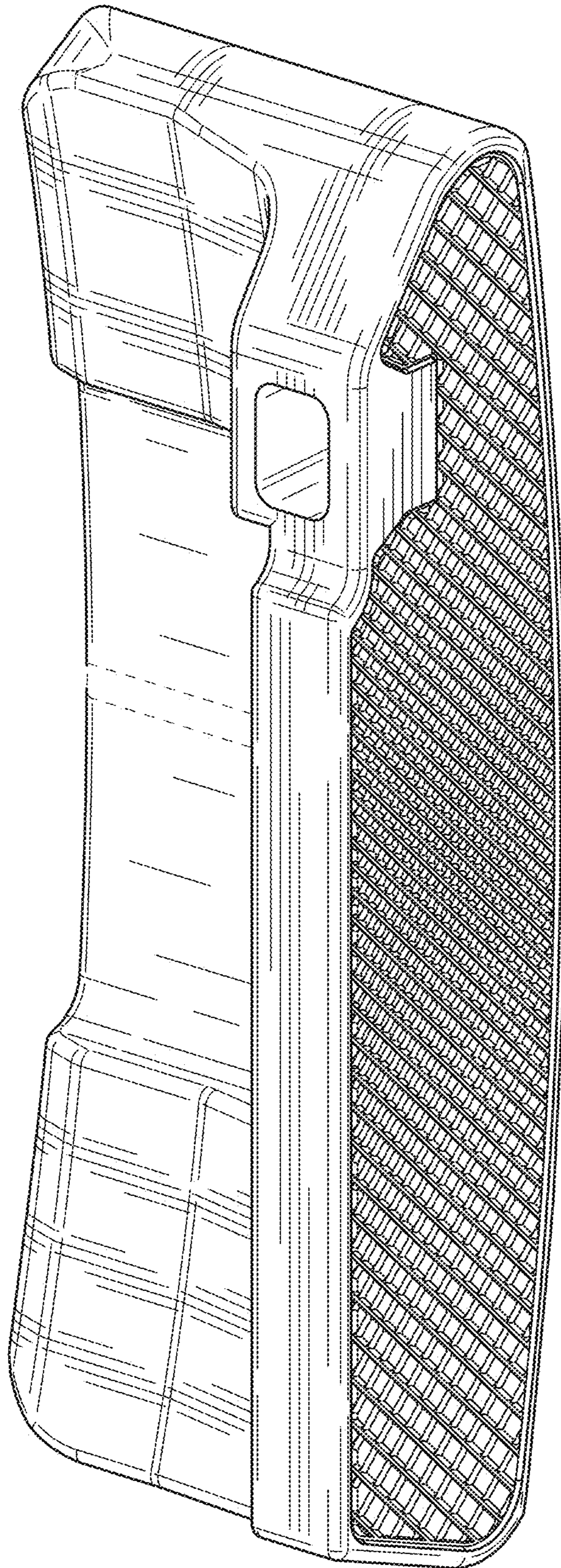

FIG. 9

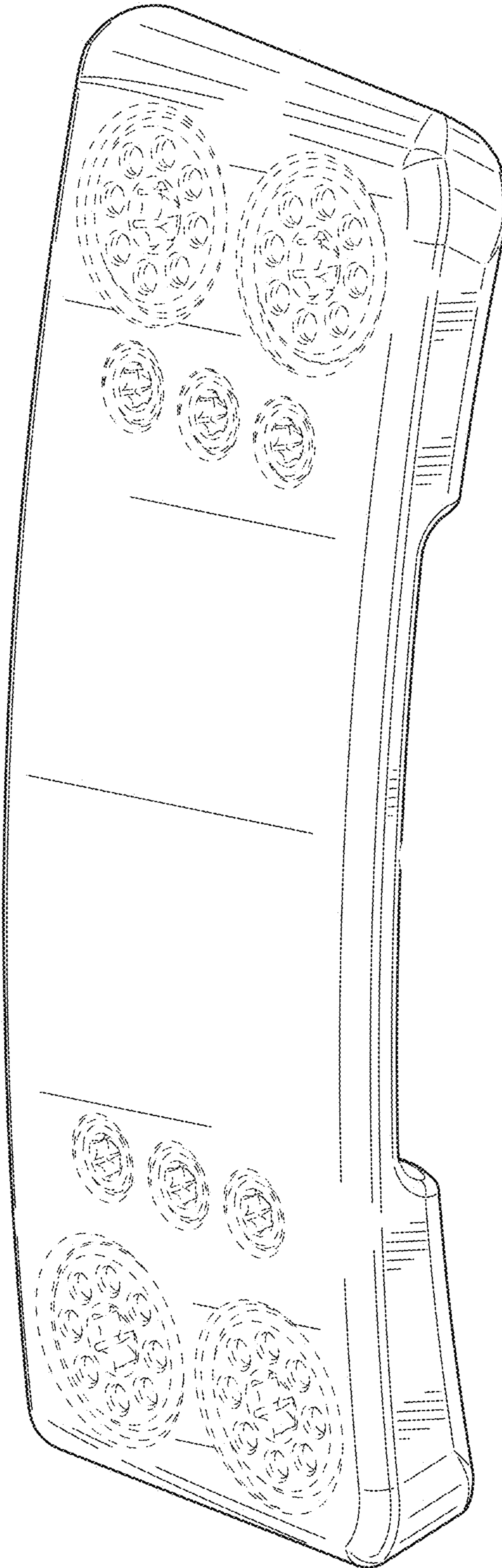

FIG. 10



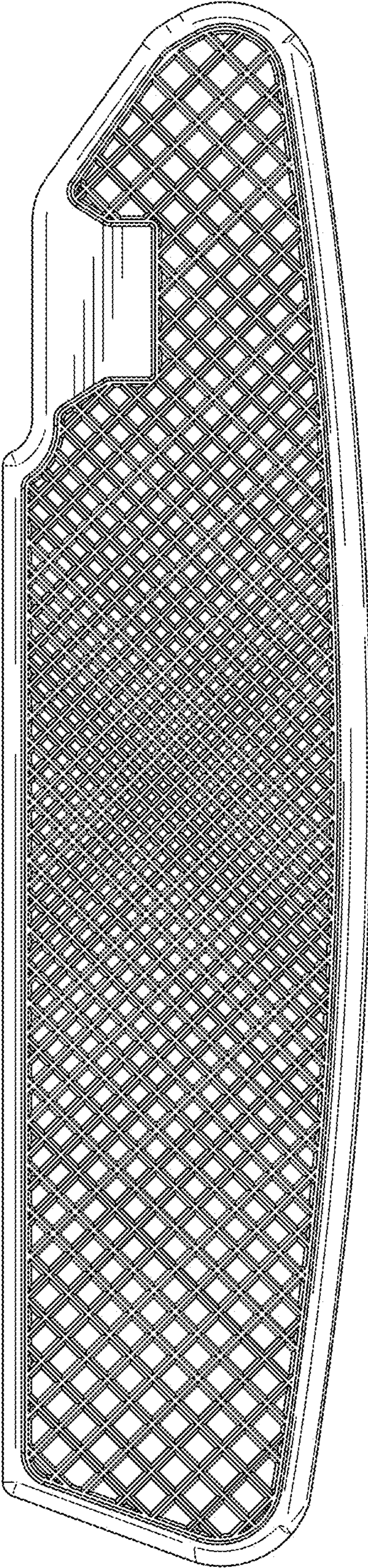

FIG. 11

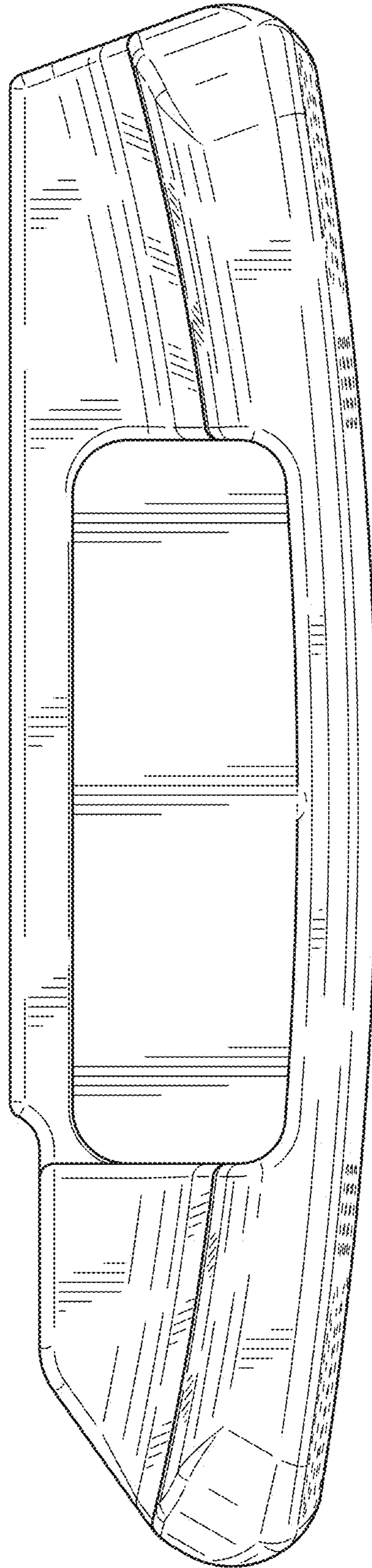

FIG. 12



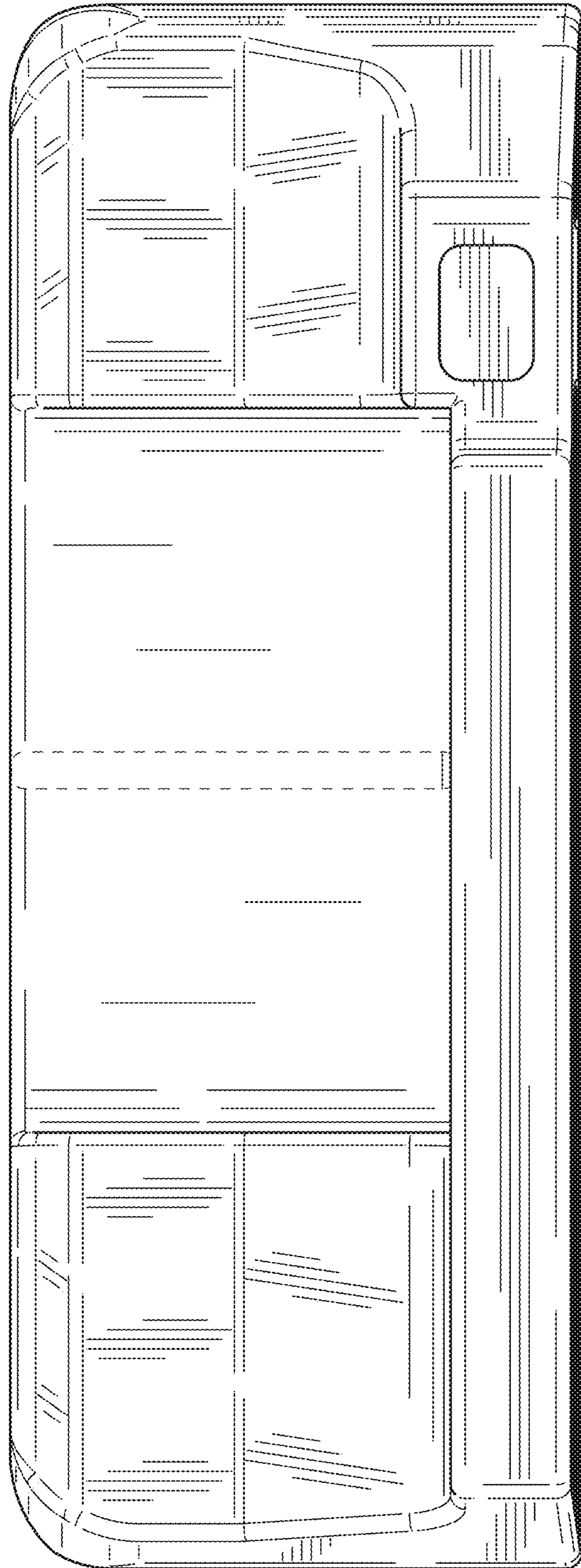

FIG. 13

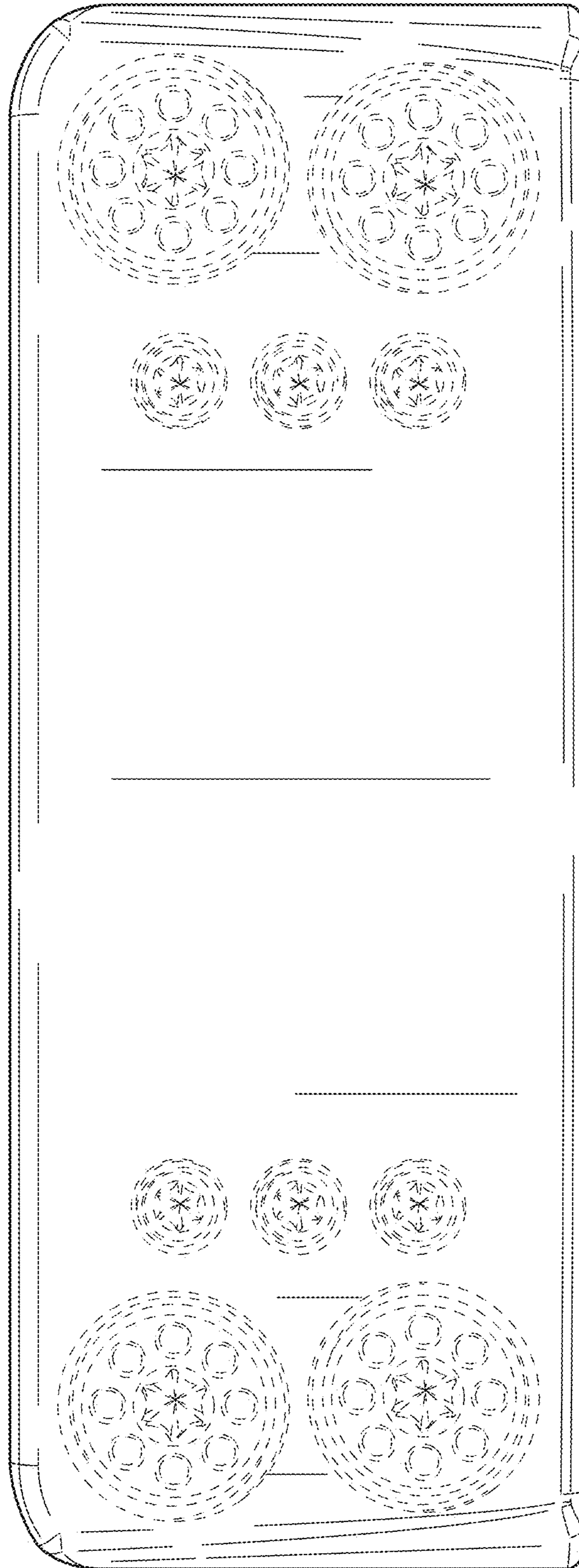

FIG. 14



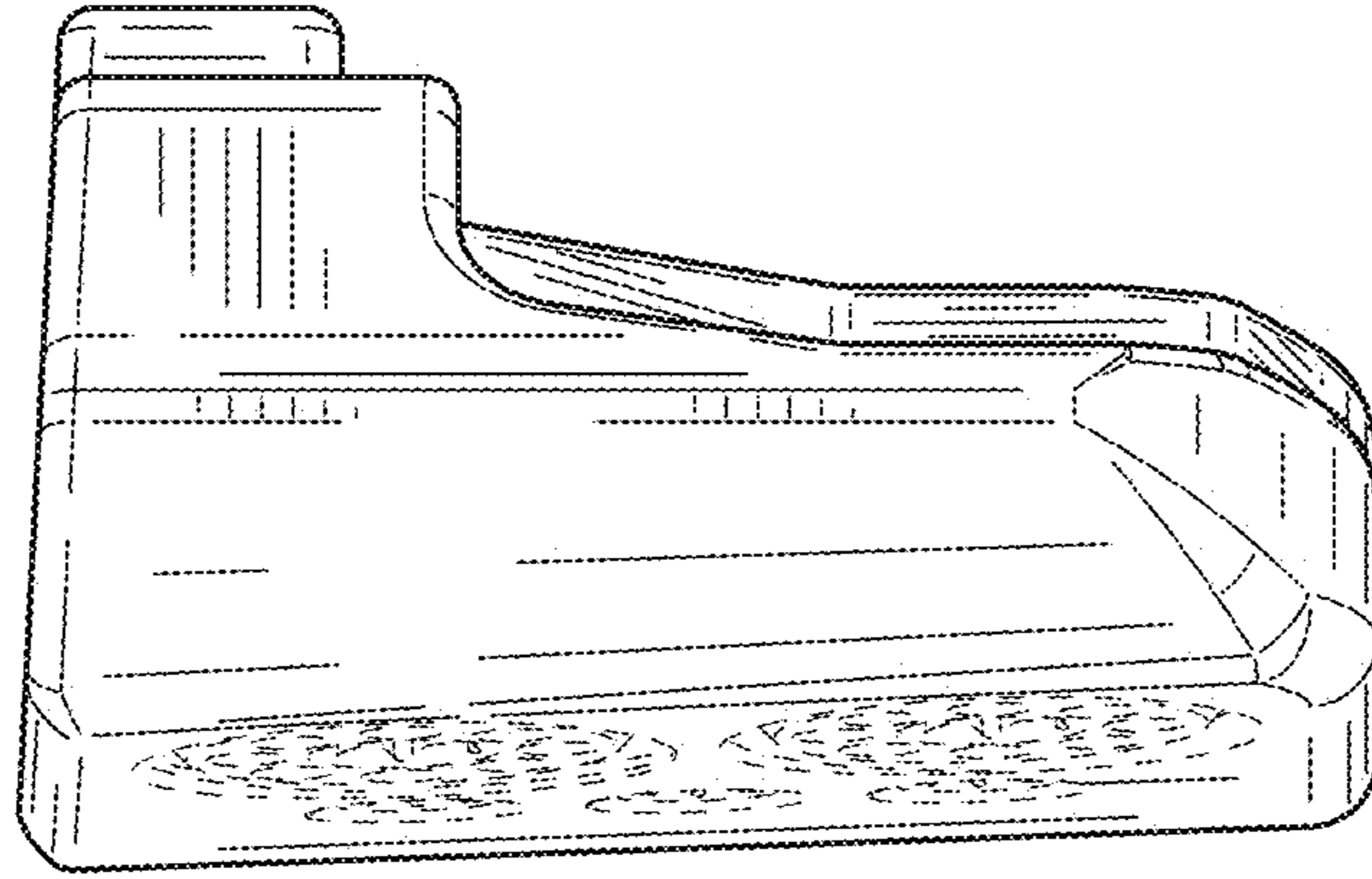

FIG. 15

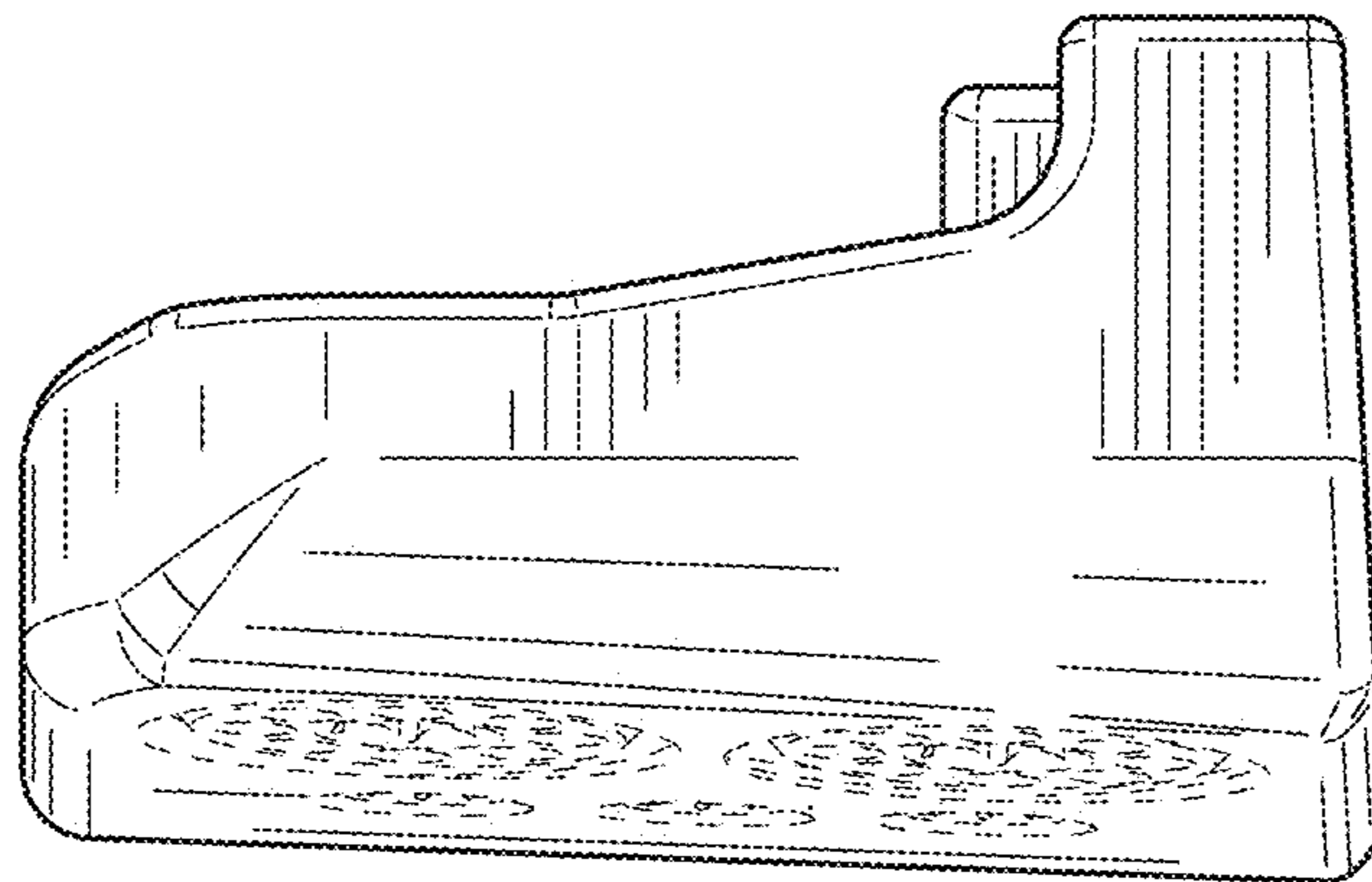

FIG. 16

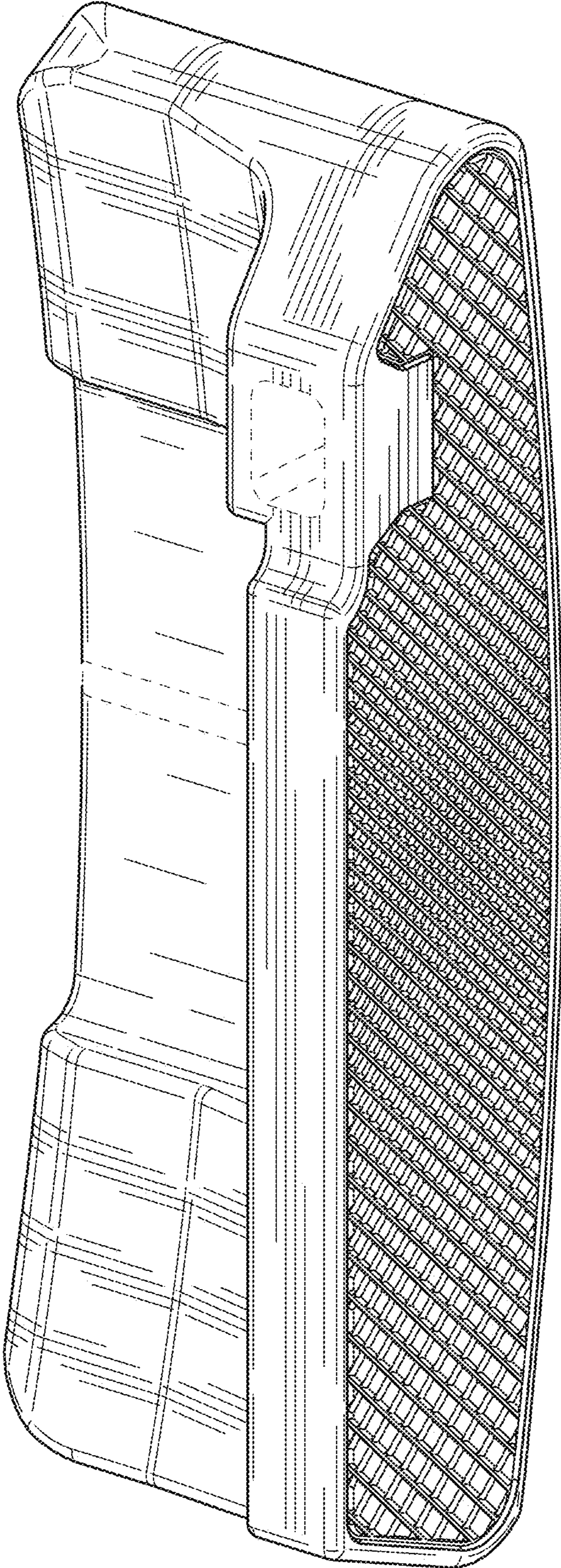

FIG. 17



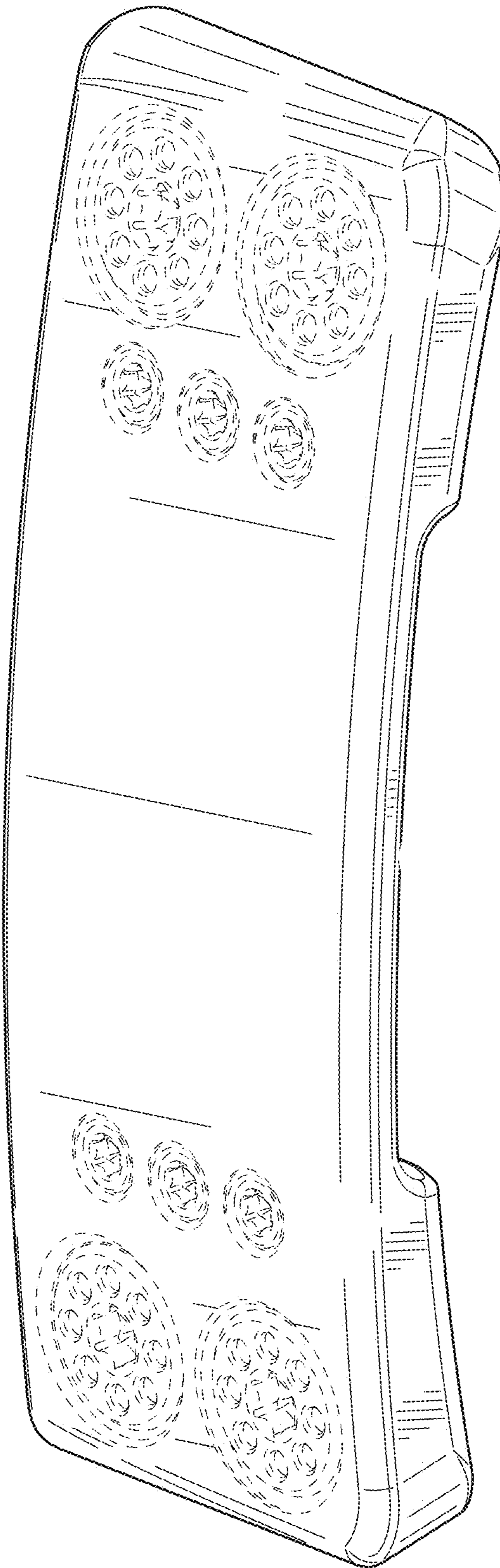

FIG. 18



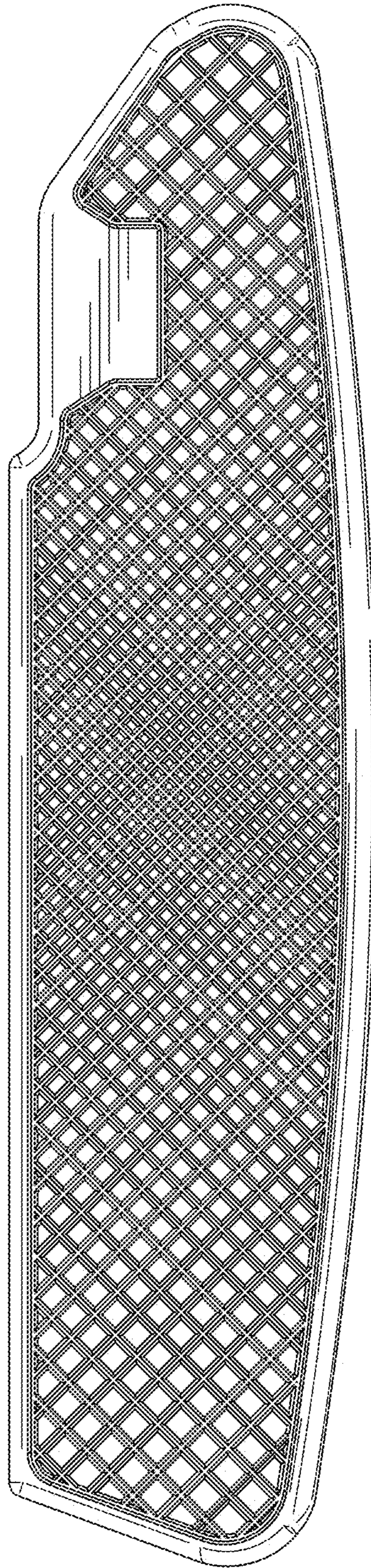

FIG. 19



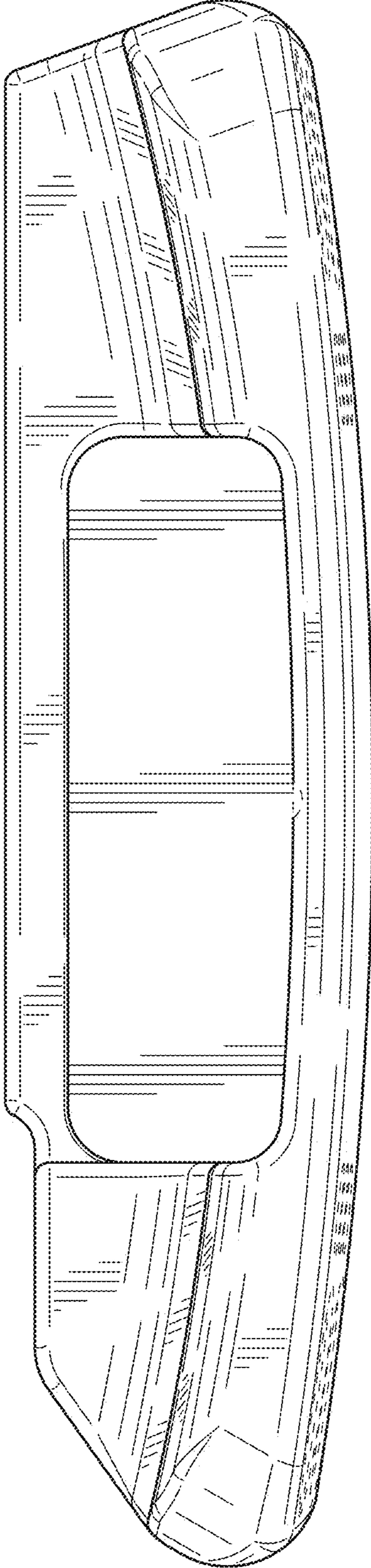

FIG. 20

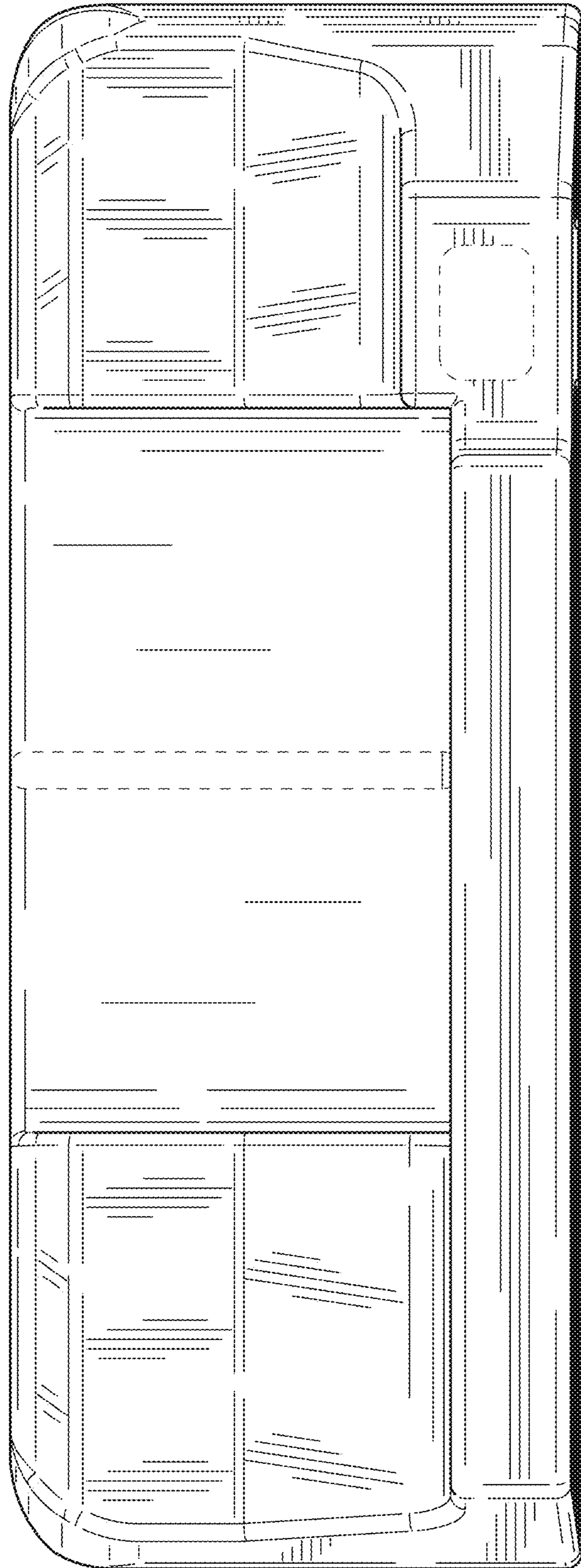

FIG. 21



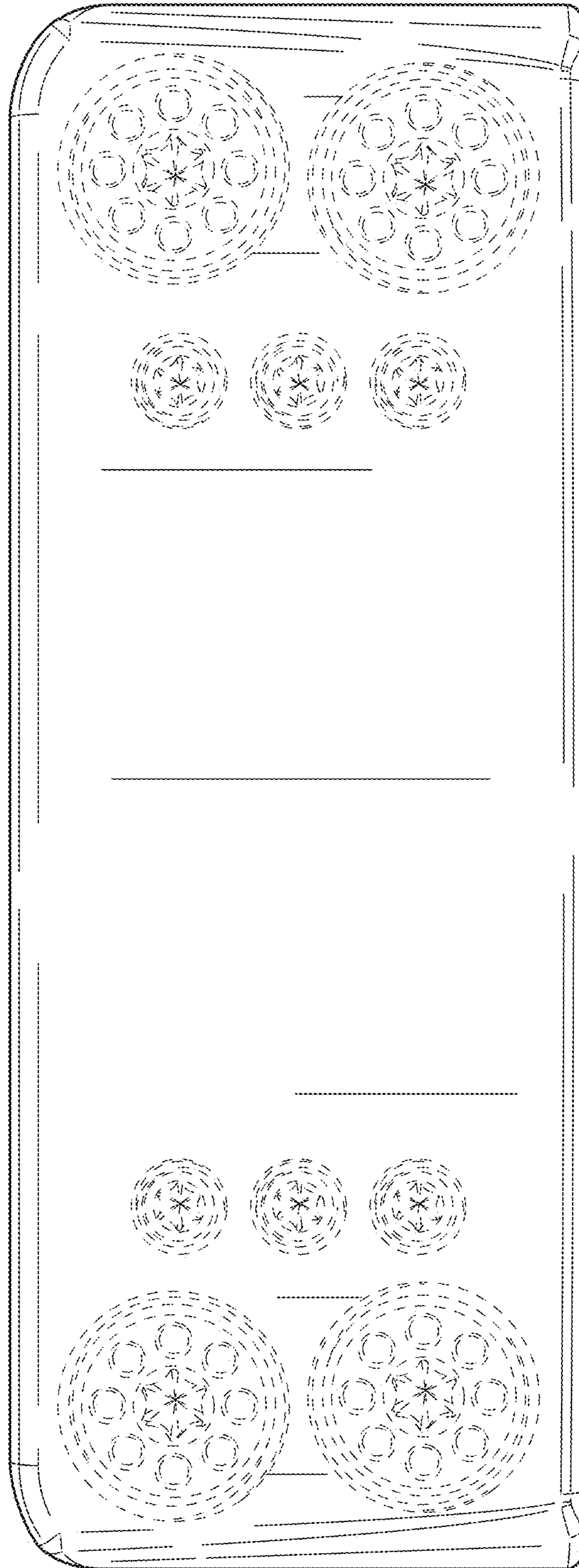

FIG. 22

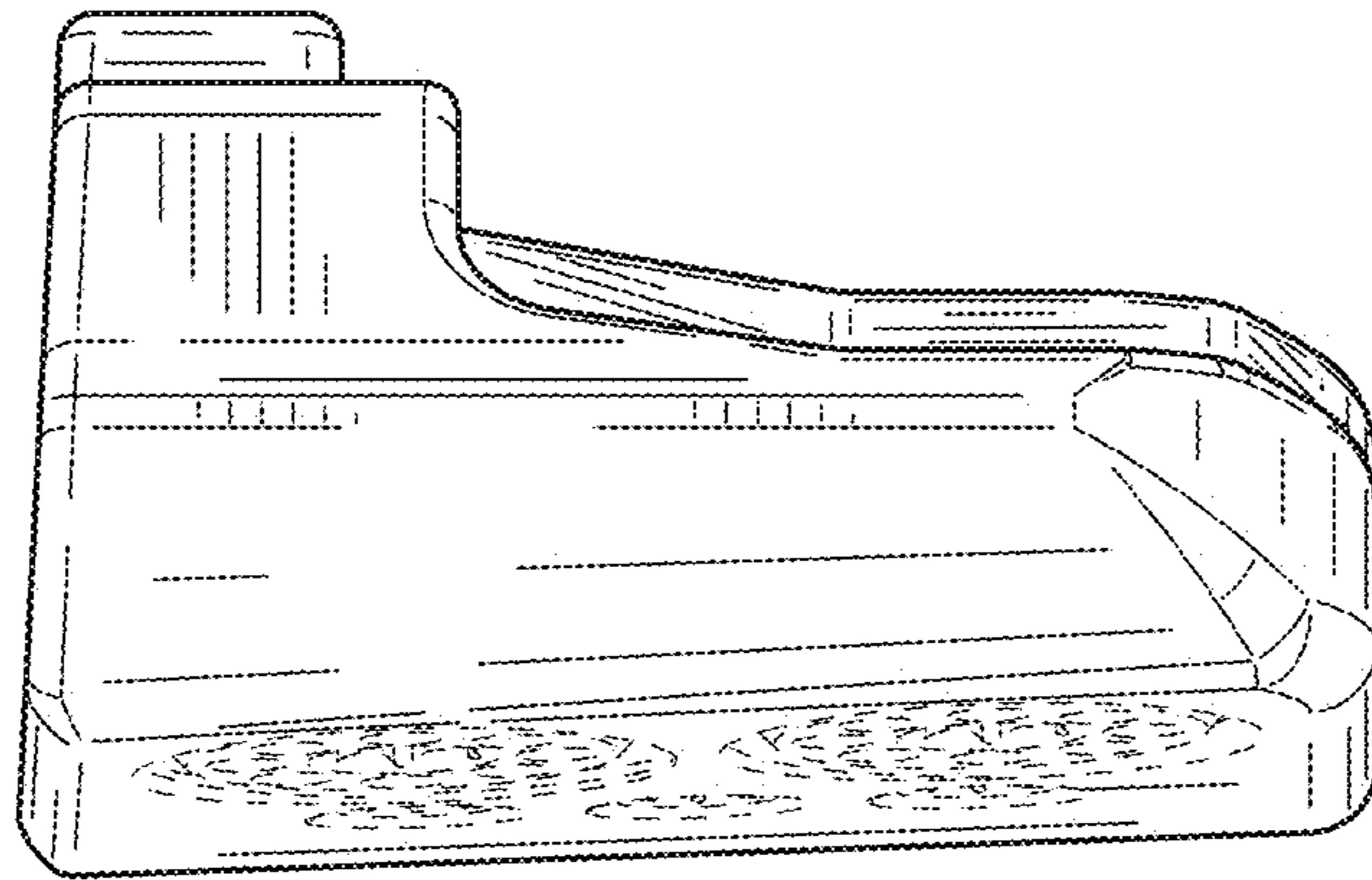

FIG. 23

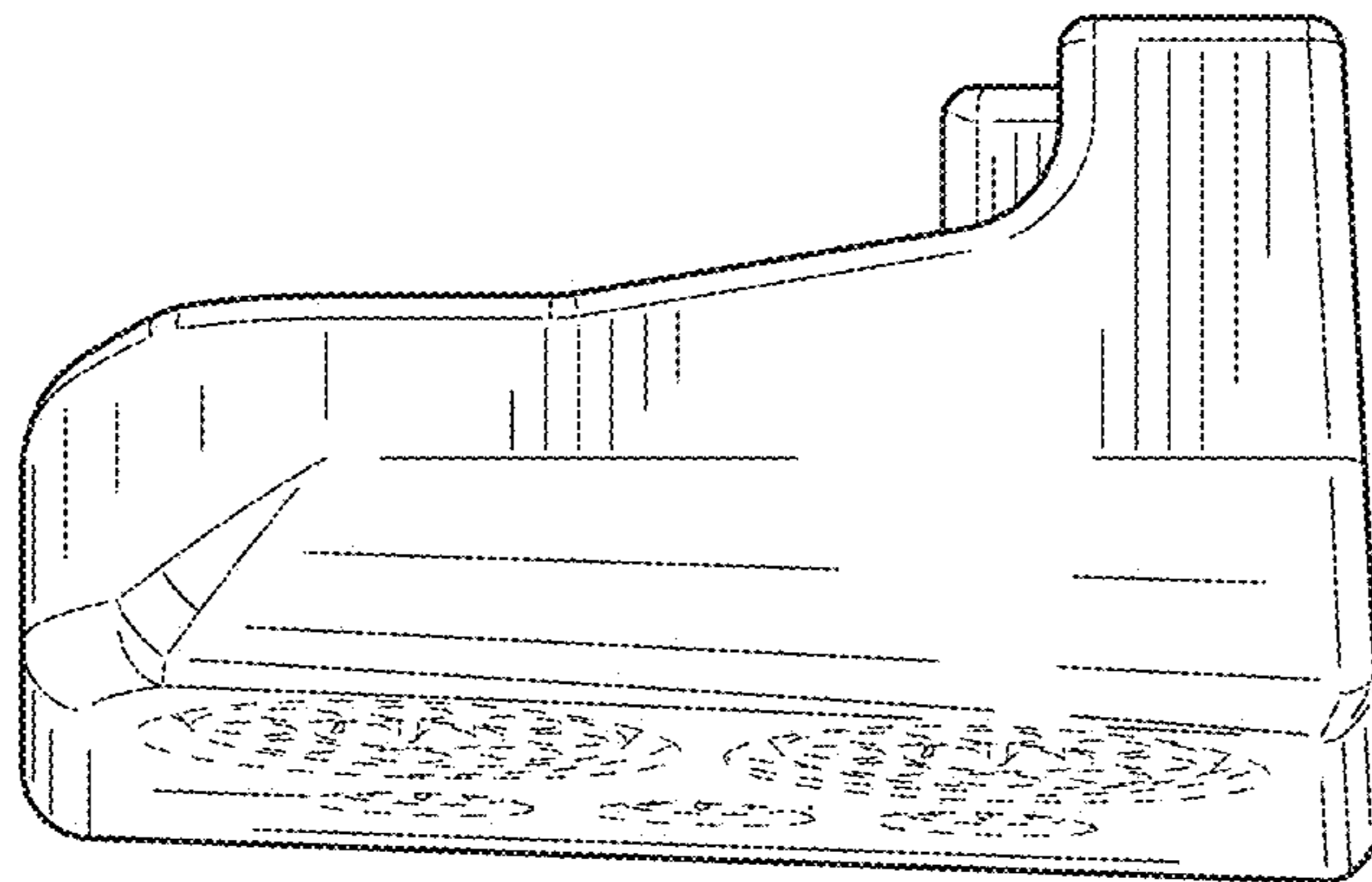

FIG. 24