

US00D962346S

(12) **United States Design Patent**  
**Legras**

(10) **Patent No.:** **US D962,346 S**

(45) **Date of Patent:** **\*\* Aug. 30, 2022**

(54) **GAMING APPARATUS INCLUDING  
MULTIPLE WHEEL DISPLAY**

8,308,547 B2 11/2012 Walker et al.  
8,371,931 B2 \* 2/2013 Decasa ..... G07F 17/3232  
463/20

(71) Applicant: **IGT, Las Vegas, NV (US)**

8,414,381 B2 4/2013 Hein et al.  
(Continued)

(72) Inventor: **Jean-Pierre Legras, Carson City, NV  
(US)**

**OTHER PUBLICATIONS**

(73) Assignee: **IGT, Las Vegas, NV (US)**

Picture of Aristocrat Batman gaming system, available prior to Nov.  
26, 2018 (1 page).

(\*\*) Term: **15 Years**

(Continued)

(21) Appl. No.: **29/671,226**

*Primary Examiner* — Michael C Stout

*Assistant Examiner* — Melvin L Davis

(22) Filed: **Nov. 26, 2018**

(74) *Attorney, Agent, or Firm* — Neal, Gerber &  
Eisenberg LLP

(51) **LOC (13) Cl.** ..... **21-01**

(52) **U.S. Cl.**  
USPC ..... **D21/325**

(57) **CLAIM**

The ornamental design for a gaming apparatus including  
multiple wheel display, as shown and described herein.

(58) **Field of Classification Search**  
USPC ..... D21/324–326, 329, 330, 332, 333  
CPC ..... A63F 9/00; A63F 9/24  
See application file for complete search history.

**DESCRIPTION**

(56) **References Cited**

**U.S. PATENT DOCUMENTS**

4,643,425 A	2/1987	Herzenberger	
5,788,573 A	8/1998	Baerlocher et al.	
6,105,962 A	8/2000	Malavazos et al.	
6,162,121 A	12/2000	Morro et al.	
6,168,520 B1	1/2001	Baerlocher et al.	
6,398,220 B1	6/2002	Inoue	
6,413,162 B1	7/2002	Baerlocher et al.	
D472,586 S	4/2003	Wichinsky	
D486,869 S	2/2004	Webb et al.	
6,793,577 B1	9/2004	Wilkins et al.	
D558,835 S	1/2008	Zielinski	
7,431,649 B2	10/2008	Webb et al.	
7,601,061 B2	10/2009	Jackson	
7,806,760 B2	10/2010	Baerlocher	
7,878,506 B1	2/2011	Kelly et al.	
D670,675 S *	11/2012	Garneau	..... D14/172

FIG. 1 is a front perspective view of a gaming apparatus including multiple wheel display of my new design.  
FIG. 2 is a front view of the gaming apparatus including multiple wheel display of FIG. 1.  
FIG. 3 is a rear view of the gaming apparatus including multiple wheel display of FIG. 1.  
FIG. 4 is a right side view of the gaming apparatus including multiple wheel display of FIG. 1.  
FIG. 5 is a left side view of the gaming apparatus including multiple wheel display of FIG. 1.  
FIG. 6 is a top view of the gaming apparatus including multiple wheel display of FIG. 1; and,  
FIG. 7 is a bottom view of the gaming apparatus including multiple wheel display of FIG. 1.  
The broken line showing of the gaming apparatus including multiple wheel display is for the purpose of illustrating portions of the article that forms no part of the claimed design.

**1 Claim, 7 Drawing Sheets**

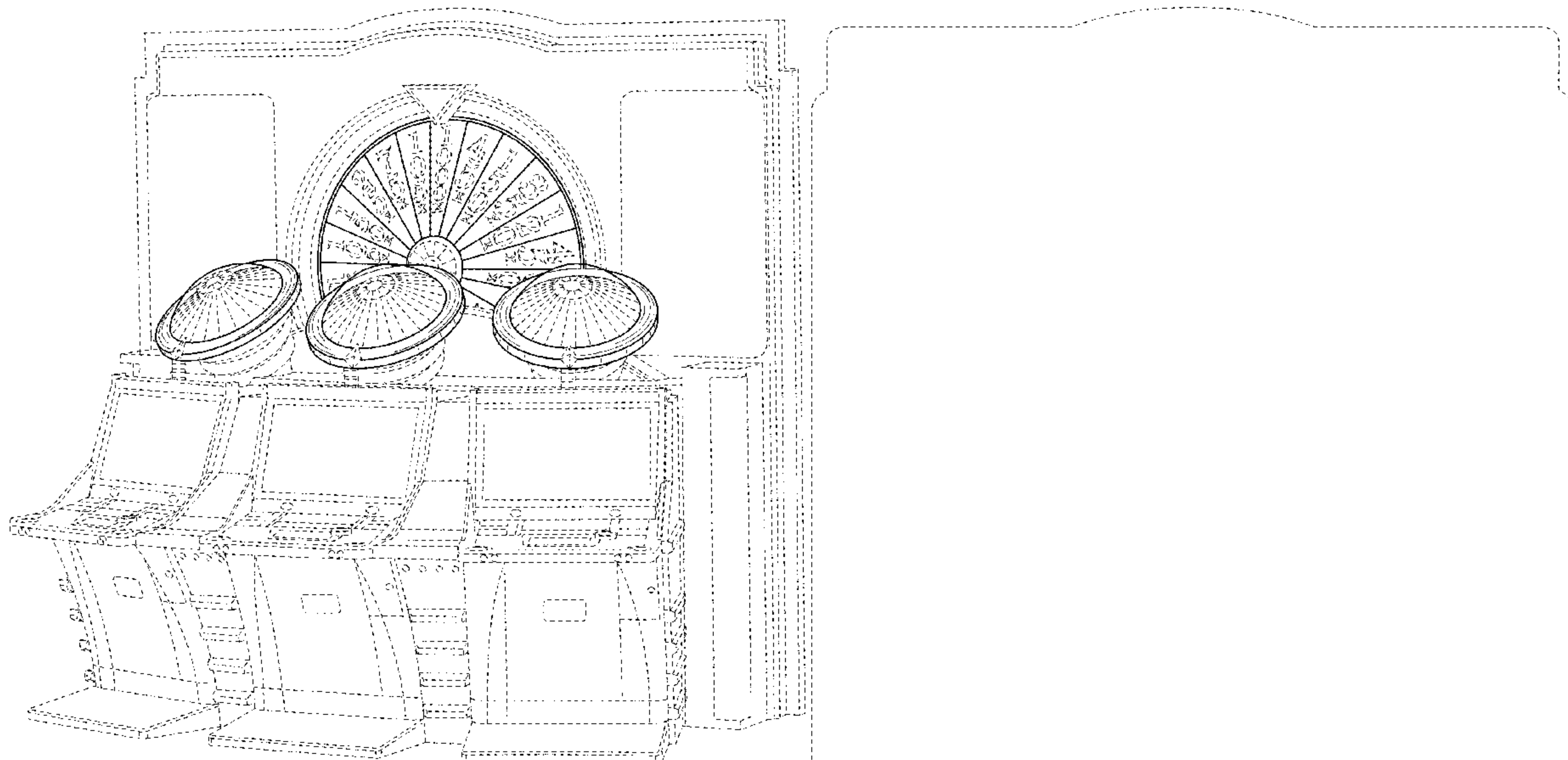

(56)

References Cited

U.S. PATENT DOCUMENTS

8,419,549 B2 \* 4/2013 Kaminkow ..... G07F 17/326  
463/46  
8,460,084 B2 6/2013 Kaminkow et al.  
8,622,808 B2 1/2014 Pececnik et al.  
8,951,116 B1 2/2015 Koenig  
8,956,216 B1 \* 2/2015 LeSourd ..... G07F 17/3213  
463/20  
8,974,280 B2 \* 3/2015 LeSourd ..... G07F 17/3213  
463/16  
D733,088 S \* 6/2015 Garneau ..... D14/172  
D734,735 S \* 7/2015 Tooker ..... D14/172  
D741,284 S \* 10/2015 Tooker ..... D14/173  
9,613,485 B2 4/2017 Barragan  
9,659,430 B2 \* 5/2017 Nicely ..... G07F 17/32  
D810,830 S \* 2/2018 Sharp ..... D21/329  
D822,117 S \* 7/2018 Costa ..... D21/325  
D827,719 S \* 9/2018 Costa ..... D21/369  
D843,468 S \* 3/2019 Johnson ..... D21/369  
D843,469 S 3/2019 Nettenstrom et al.  
D889,546 S \* 7/2020 Jones ..... D21/326  
D890,264 S \* 7/2020 Johnson ..... D21/369  
D890,849 S \* 7/2020 Johnson ..... D21/369  
D890,850 S \* 7/2020 Johnson ..... D21/369  
10,741,012 B2 \* 8/2020 Legras ..... G07F 17/3272  
D897,438 S \* 9/2020 Olive ..... D21/333  
D904,523 S \* 12/2020 Legras ..... D21/369  
D905,792 S \* 12/2020 Baerlocher ..... D21/369  
10,916,086 B2 \* 2/2021 Edick ..... G07F 17/3213  
D921,762 S \* 6/2021 Hodgson ..... D21/333  
D923,102 S \* 6/2021 McGahn ..... D21/370  
11,158,154 B2 \* 10/2021 Achmueller ..... G07F 17/3216  
D936,747 S \* 11/2021 Edwards ..... D21/369  
2001/0054794 A1 12/2001 Cole et al.

2002/0094862 A1 7/2002 Inoue  
2002/0193158 A1 12/2002 Weiss et al.  
2004/0048645 A1 3/2004 Webb et al.  
2004/0132522 A1 7/2004 Seelig et al.  
2004/0214630 A1 10/2004 Mayeroff  
2006/0019735 A1 1/2006 Toyoda  
2006/0046821 A1 3/2006 Kaminkow et al.  
2006/0073873 A1 4/2006 Rodgers et al.  
2007/0072669 A1 3/2007 Ogiwara  
2007/0202947 A1 8/2007 Seelig et al.  
2008/0051168 A1 2/2008 Kaminkow et al.  
2008/0064468 A1 3/2008 Okada  
2008/0064469 A1 3/2008 Okada  
2008/0113756 A1 5/2008 Williams et al.  
2008/0139280 A1 6/2008 Inamura  
2010/0041464 A1 2/2010 Arezina et al.  
2012/0115562 A1 5/2012 Kido et al.  
2012/0157183 A1 6/2012 Mead  
2013/0143640 A1 6/2013 Young  
2013/0143650 A1 6/2013 Rodgers et al.  
2013/0316781 A1 11/2013 Pececnik et al.  
2015/0050978 A1 2/2015 Brooks et al.  
2015/0321082 A1 11/2015 Kawabata et al.  
2016/0189470 A1 6/2016 Barragan

OTHER PUBLICATIONS

Picture of Bonus Screen Display gaming machine, available prior to Nov. 26, 2018 (1 page).  
Picture of Wheel of Fortune gaming machine, available prior to Nov. 26, 2018 (1 page).  
Picture of Wheel of Fortune gaming machine display device, available prior to Nov. 26, 2018 (1 page).

\* cited by examiner



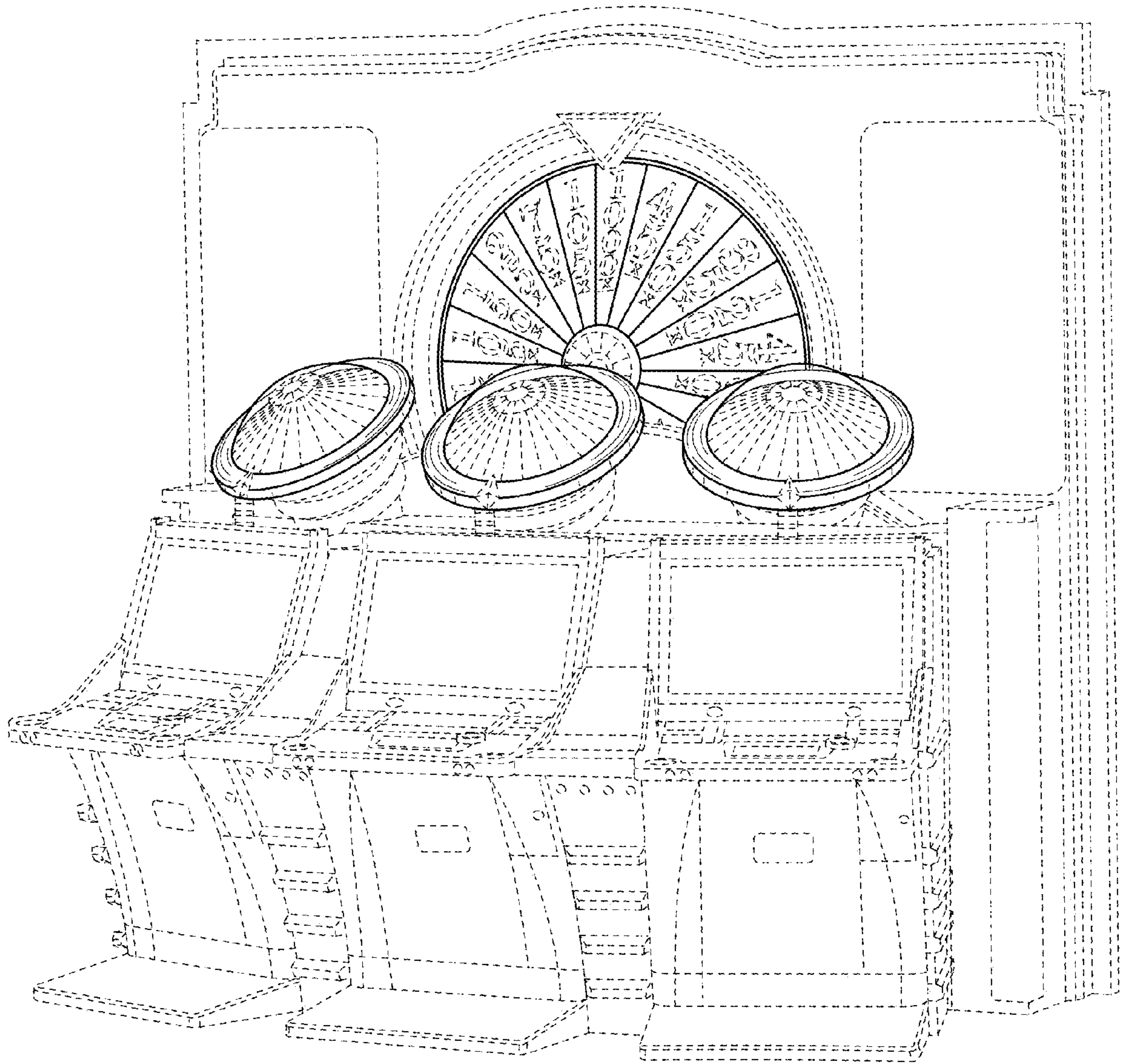

FIG. 1

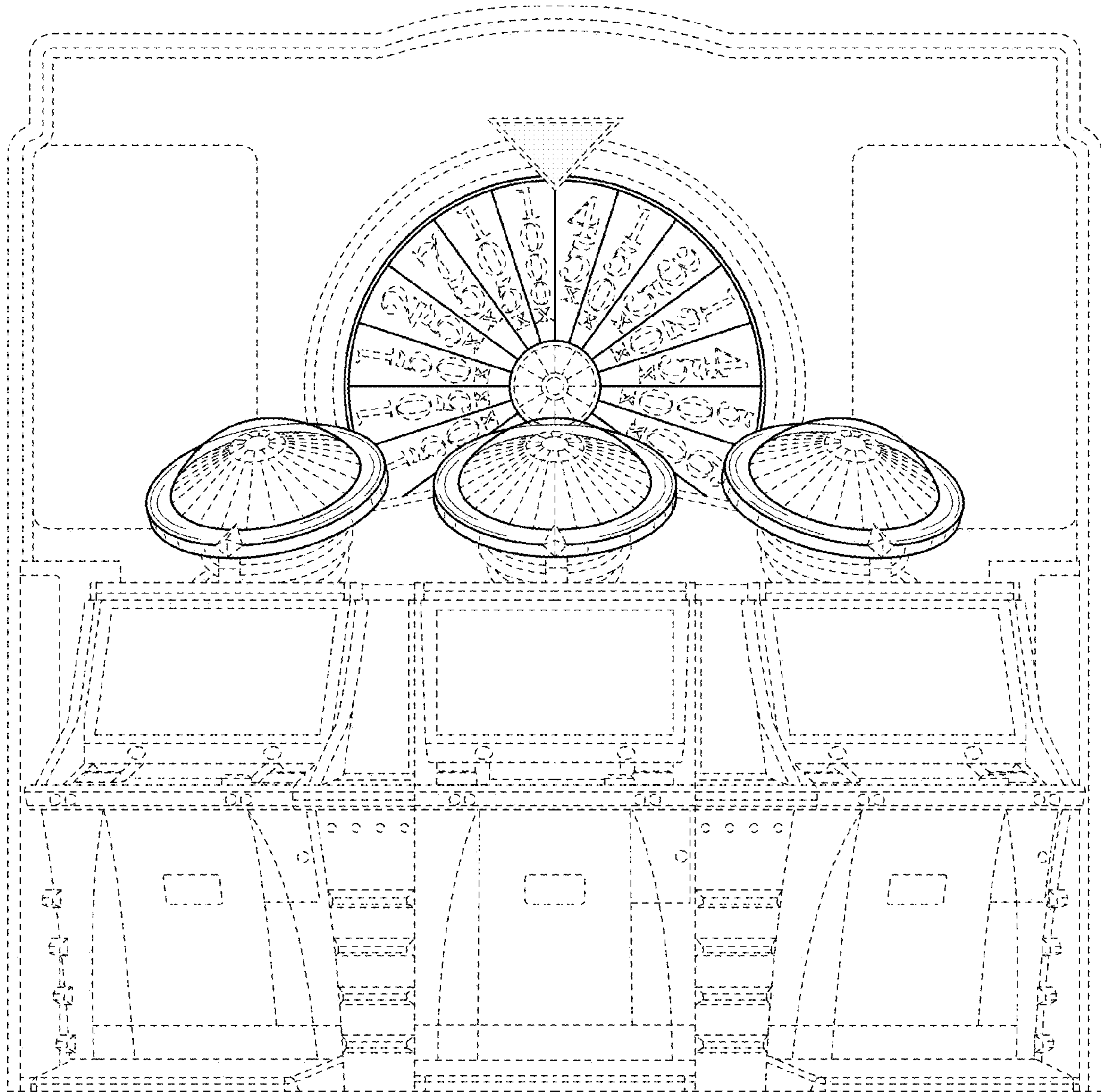
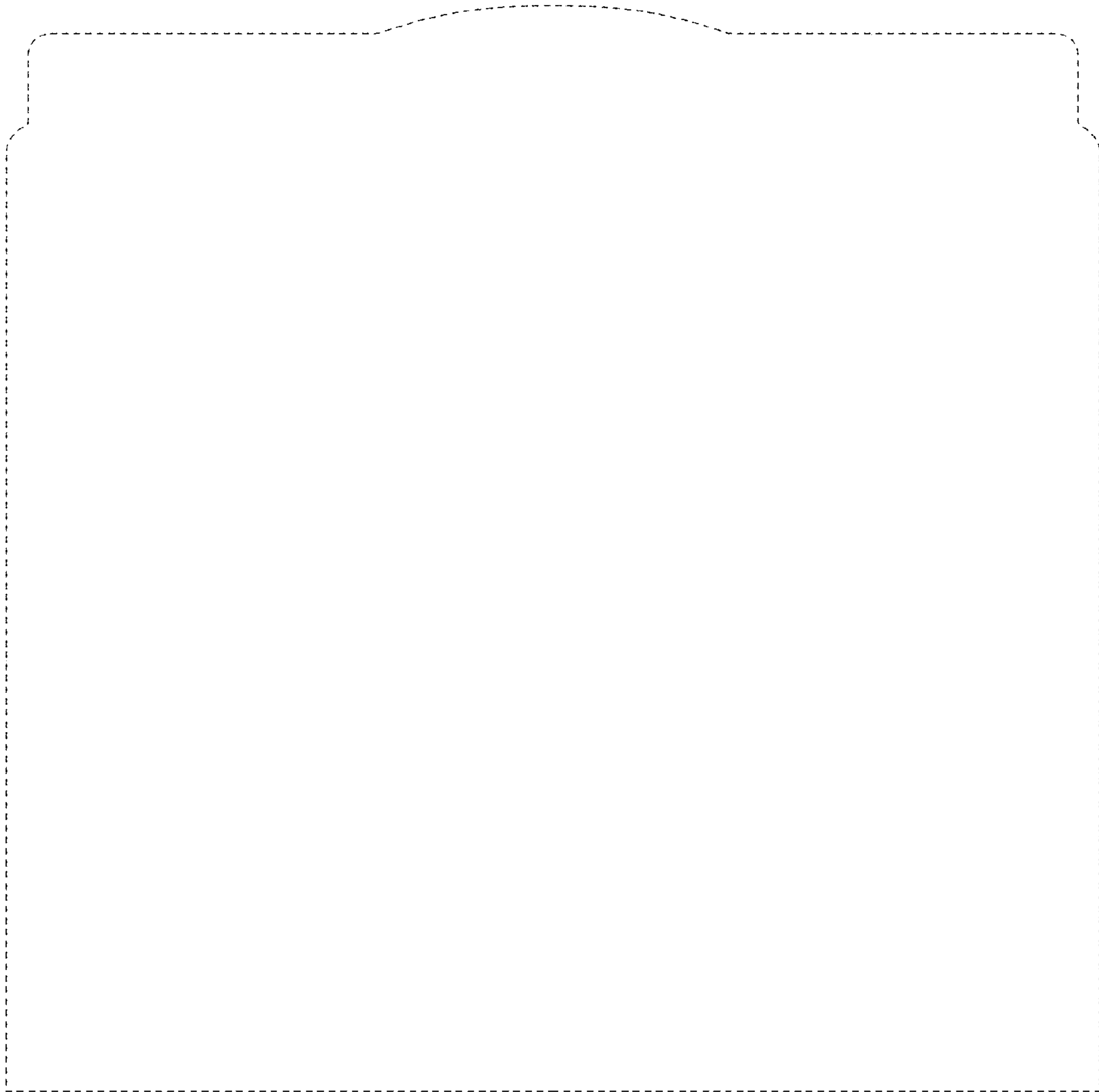

FIG. 2



**FIG. 3**

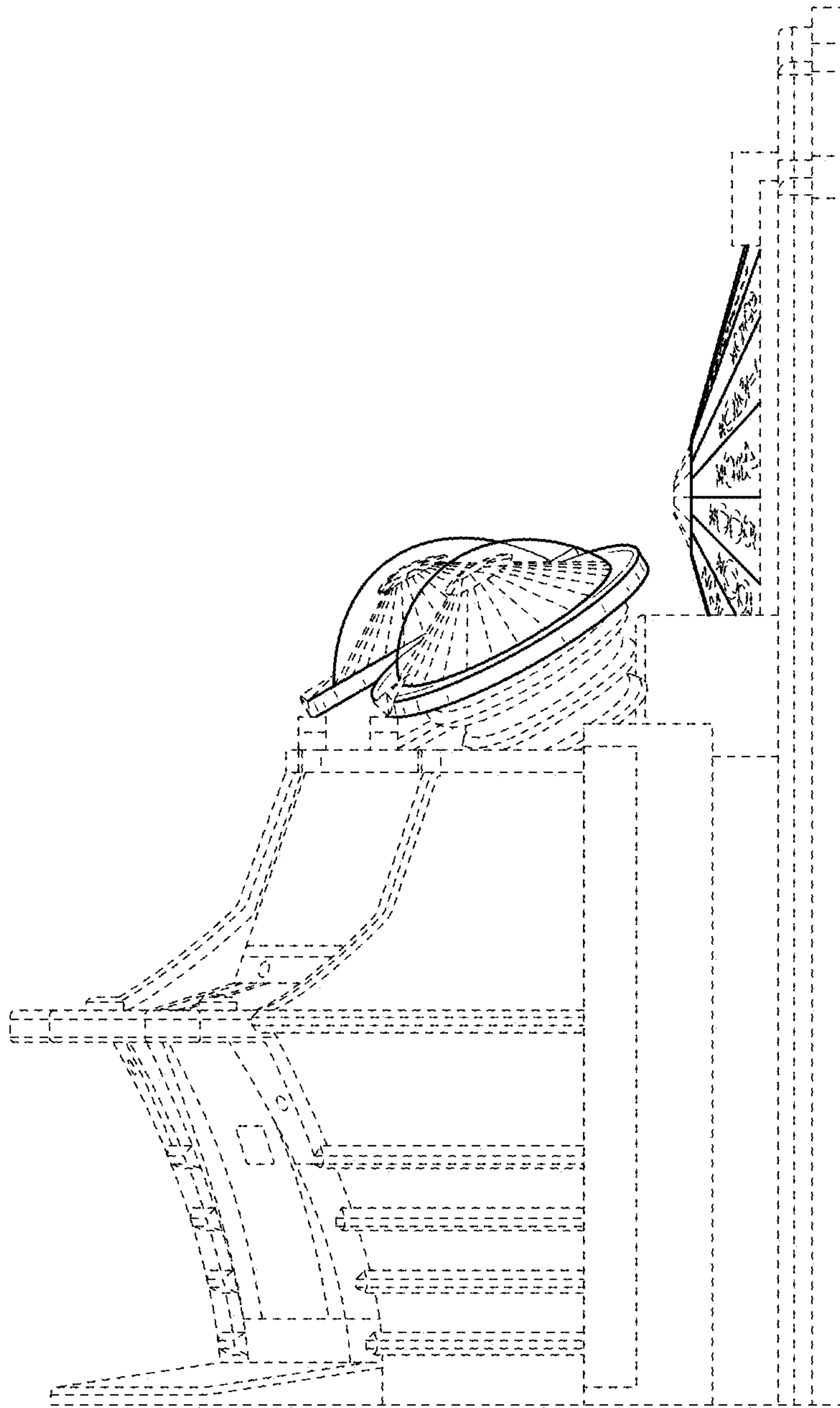

FIG. 4



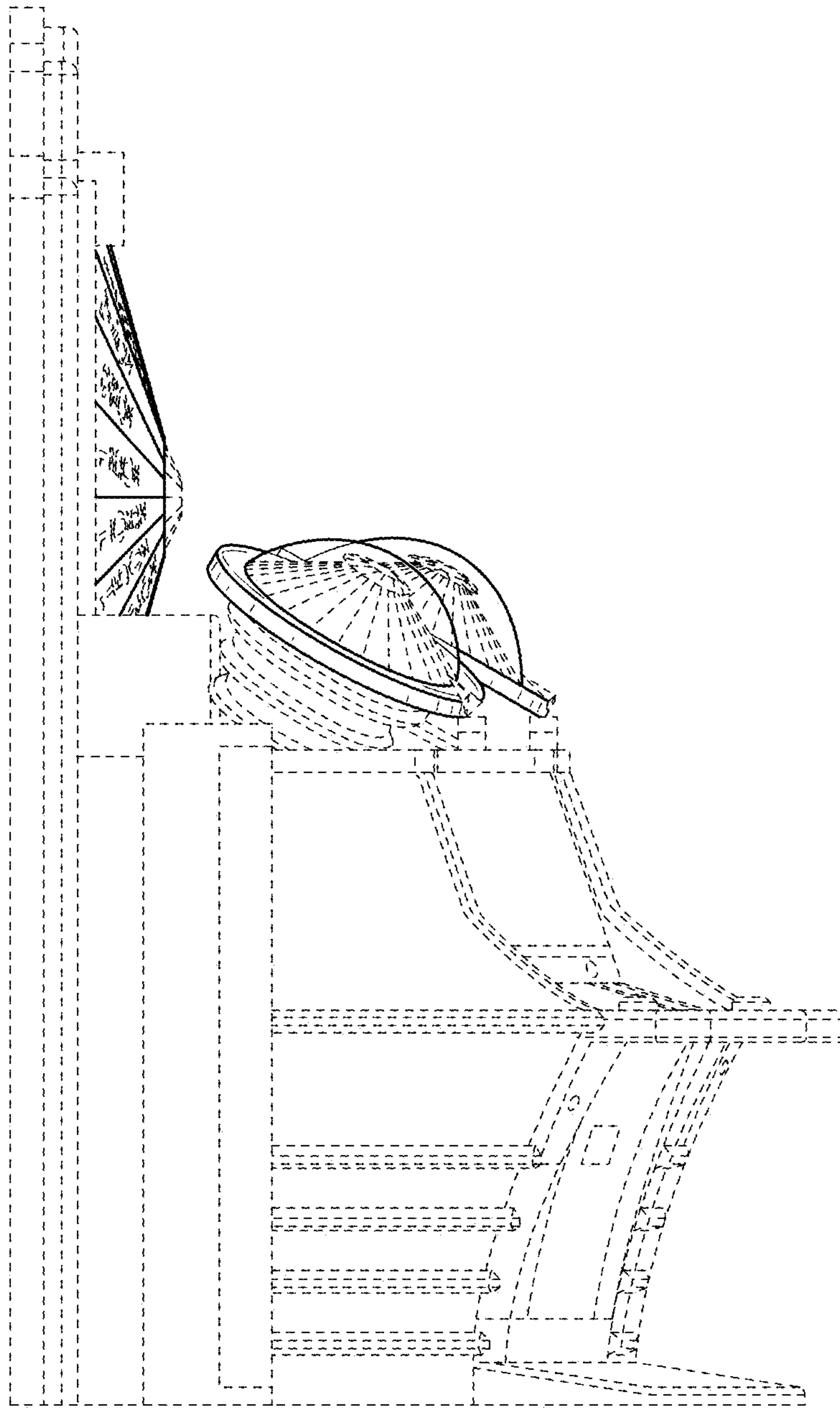

FIG. 5

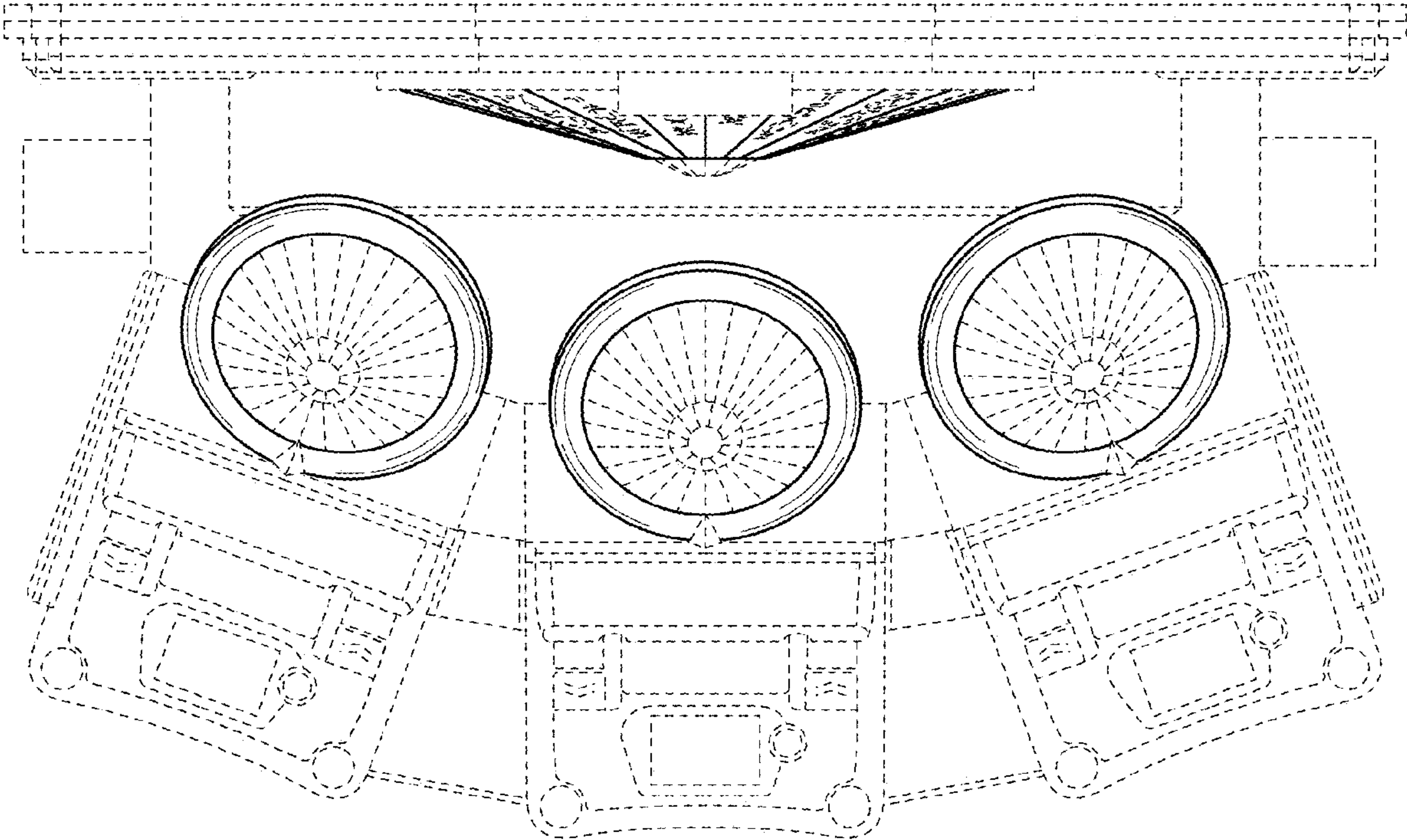

FIG. 6



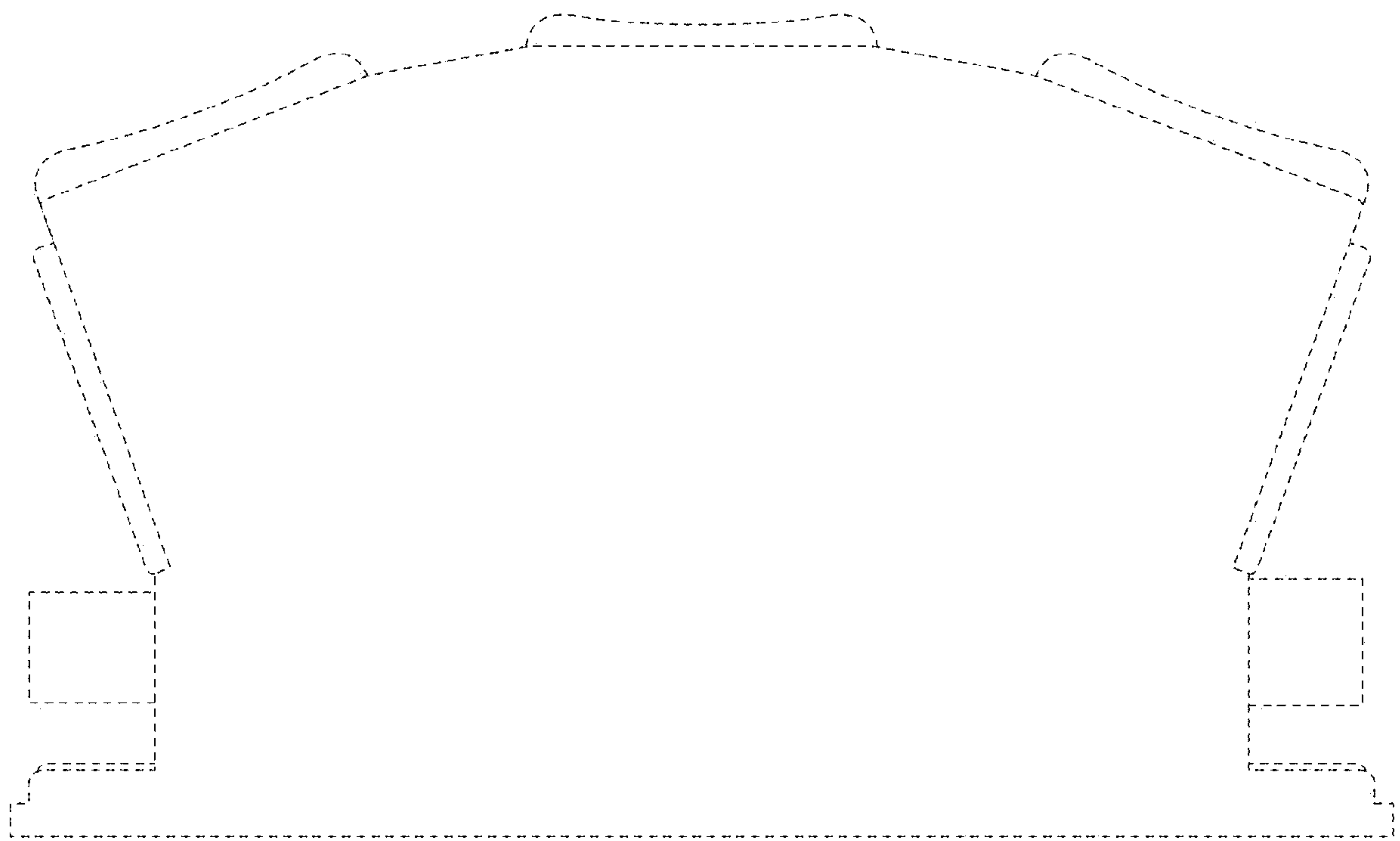

FIG. 7