



US00D962310S

(12) **United States Design Patent** (10) **Patent No.:** **US D962,310 S**  
**Cho et al.** (45) **Date of Patent:** **\*\* Aug. 30, 2022**

(54) **REFRIGERATOR**

(71) Applicant: **LG ELECTRONICS INC.**, Seoul (KR)

(72) Inventors: **Sangwoog Cho**, Seoul (KR); **Kyukwan Choi**, Seoul (KR); **Sanghun Kim**, Seoul (KR); **Seungjin Yoon**, Seoul (KR)

(73) Assignee: **LG ELECTRONICS INC.**, Seoul (KR)

(\*\*) Term: **15 Years**

(21) Appl. No.: **29/810,319**

(22) Filed: **Oct. 4, 2021**

(30) **Foreign Application Priority Data**

Apr. 5, 2021 (KR) ..... 30-2021-0016350

(51) **LOC (13) Cl.** ..... **15-07**

(52) **U.S. Cl.**  
USPC ..... **D15/86**; D15/81; D15/91

(58) **Field of Classification Search**  
USPC ..... D15/79-91  
CPC ..... F25D 2323/021; F25D 2323/024; F25D 29/00; F25D 27/005; F25D 29/005; F25D 17/042; F25D 2325/021; F25D 11/00; F25D 11/02; F25D 11/025; F25D 23/00; F25D 23/02; F25D 23/04; F25D 23/12; F25D 23/028; F25D 25/02; F25D 25/021; F25D 25/022; F25D 25/024; F25D 25/025; A47F 3/04; A47F 3/0404

See application file for complete search history.

(56) **References Cited**

**U.S. PATENT DOCUMENTS**

D603,429 S \* 11/2009 Lee ..... D15/85  
D657,805 S \* 4/2012 Cho ..... D15/86

D658,215 S \* 4/2012 Seo ..... D15/86  
D715,335 S \* 10/2014 Kim ..... D15/85  
D729,285 S \* 5/2015 Seo ..... D15/85  
D740,335 S \* 10/2015 Hwang ..... D15/89

(Continued)

**OTHER PUBLICATIONS**

LG Electronics, LRFDS3016S 36 Inch Smart French Door Craft Ice Refrigerator, (site visited Dec. 16, 2021), AJ Madison website, URL:<<https://www.ajmadison.com/cgi-bin/ajmadison/LRFDS3016.html>> (Year: 2021).\*

(Continued)

*Primary Examiner* — Calvin E Vansant  
*Assistant Examiner* — Mark T. Philipps  
(74) *Attorney, Agent, or Firm* — Birch, Stewart, Kolasch & Birch, LLP

(57) **CLAIM**

The ornamental design for a refrigerator, as shown and described.

**DESCRIPTION**

FIG. 1 is a front perspective view of the refrigerator showing our new design;  
FIG. 2 is a front view thereof;  
FIG. 3 is a back view thereof;  
FIG. 4 is a left side view thereof;  
FIG. 5 is a right side view thereof;  
FIG. 6 is a top plan view thereof;  
FIG. 7 is a bottom plan view thereof;  
FIG. 8 is a partial enlarged view of a portion of FIG.1; and,  
FIG. 9 is a perspective view showing the design in a state of use.

The broken lines depict portions of the refrigerator that form no part of the claimed design. The long dash-short dash-long dash broken lines on FIG. 1 and FIG. 8 depict the boundary of the enlarged view on FIGS. 8, taken from FIG. 1, and form no part of the claimed design.

**1 Claim, 9 Drawing Sheets**

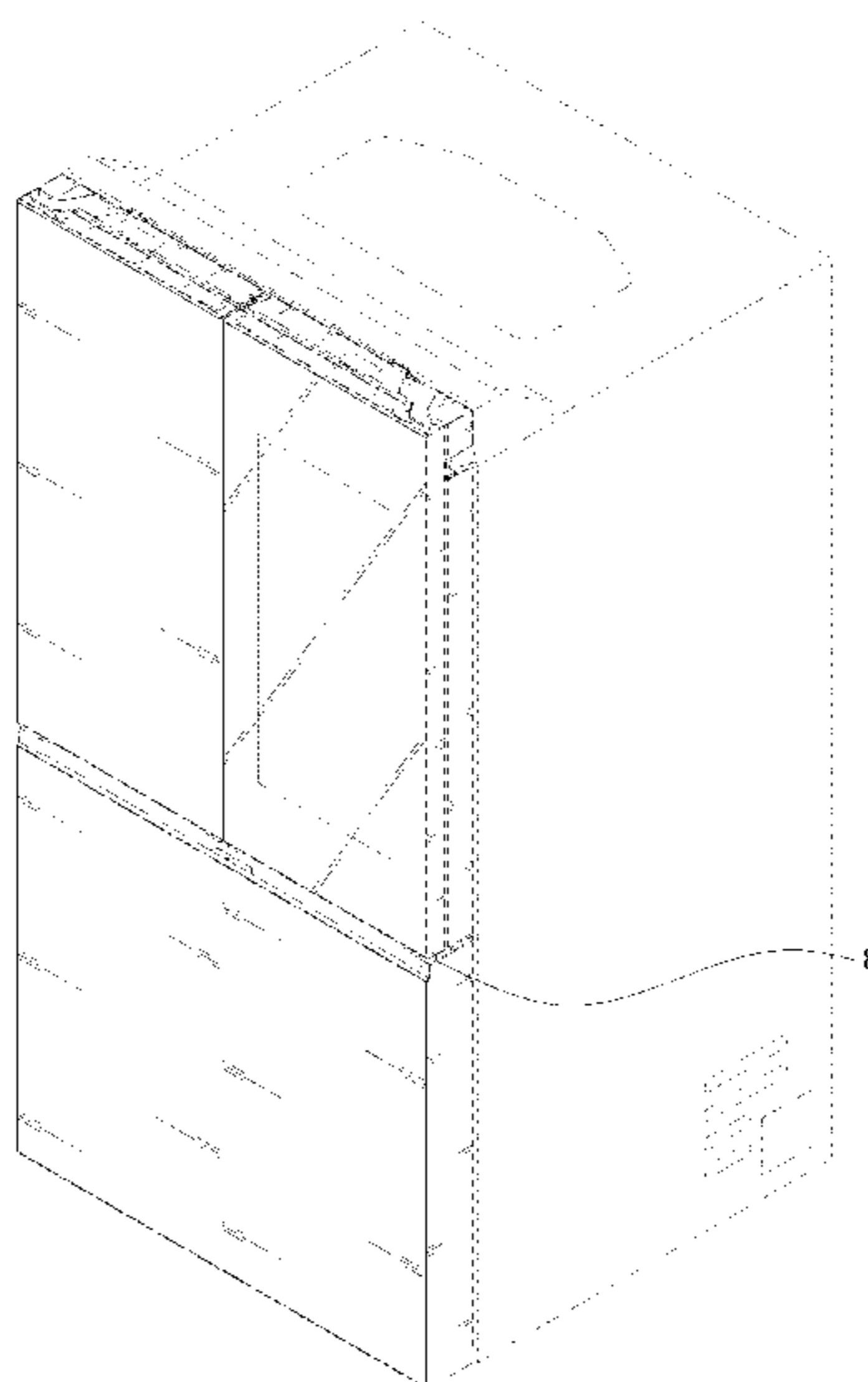

(56)

References Cited

U.S. PATENT DOCUMENTS

D741,380	S *	10/2015	Ogg	.....	D15/86
D786,317	S *	5/2017	Kim	.....	D15/85
D798,915	S *	10/2017	Vicari	.....	D15/86
D807,410	S *	1/2018	Cho	.....	D15/86
D814,533	S *	4/2018	Kim	.....	D15/85
D832,312	S *	10/2018	Kim	.....	D15/86
D838,297	S *	1/2019	Choi	.....	D15/81
D847,875	S *	5/2019	Kim	.....	D15/85
D869,518	S *	12/2019	Lee	.....	D15/85
D888,110	S *	6/2020	Lee	.....	D15/85
D905,767	S *	12/2020	Lee	.....	D15/89
D921,064	S *	6/2021	Lee	.....	D15/89
D921,065	S *	6/2021	Lee	.....	D15/89
D921,711	S *	6/2021	Lee	.....	D15/85
D921,714	S *	6/2021	Yoon	.....	D15/86
D933,110	S *	10/2021	Lee	.....	D15/86
2015/0069900	A1 *	3/2015	Lim	.....	F25D 23/025 312/405
2015/0225225	A1 *	8/2015	Tae	.....	B67D 1/0858 222/146.2

OTHER PUBLICATIONS

Samsung, RF23A9671SR 36 Inch Counter Depth 4-Door Flex™ Smart Refrigerator, (site visited Dec. 16, 2021), AJ Madison website, URL:<<https://www.ajmadison.com/cgi-bin/ajmadison/RF23A9671.html>> (Year: 2021).\*

Cafe, CQE28DM5NS5 36 Inch 4-Door French Door Smart Refrigerator, (site visited Dec. 16, 2021), AJ Madison website, URL:<<https://www.ajmadison.com/cgi-bin/ajmadison/CQE28DM5NS5.html>> (Year: 2021).\*

Dacor, DRF36C700SR 36 Inch Smart French Door Refrigerator, (site visited Dec. 16, 2021), AJ Madison website, URL:<<https://www.ajmadison.com/cgi-bin/ajmadison/DRF36C700X.html>> (Year: 2021).\*

\* cited by examiner

FIG. 1

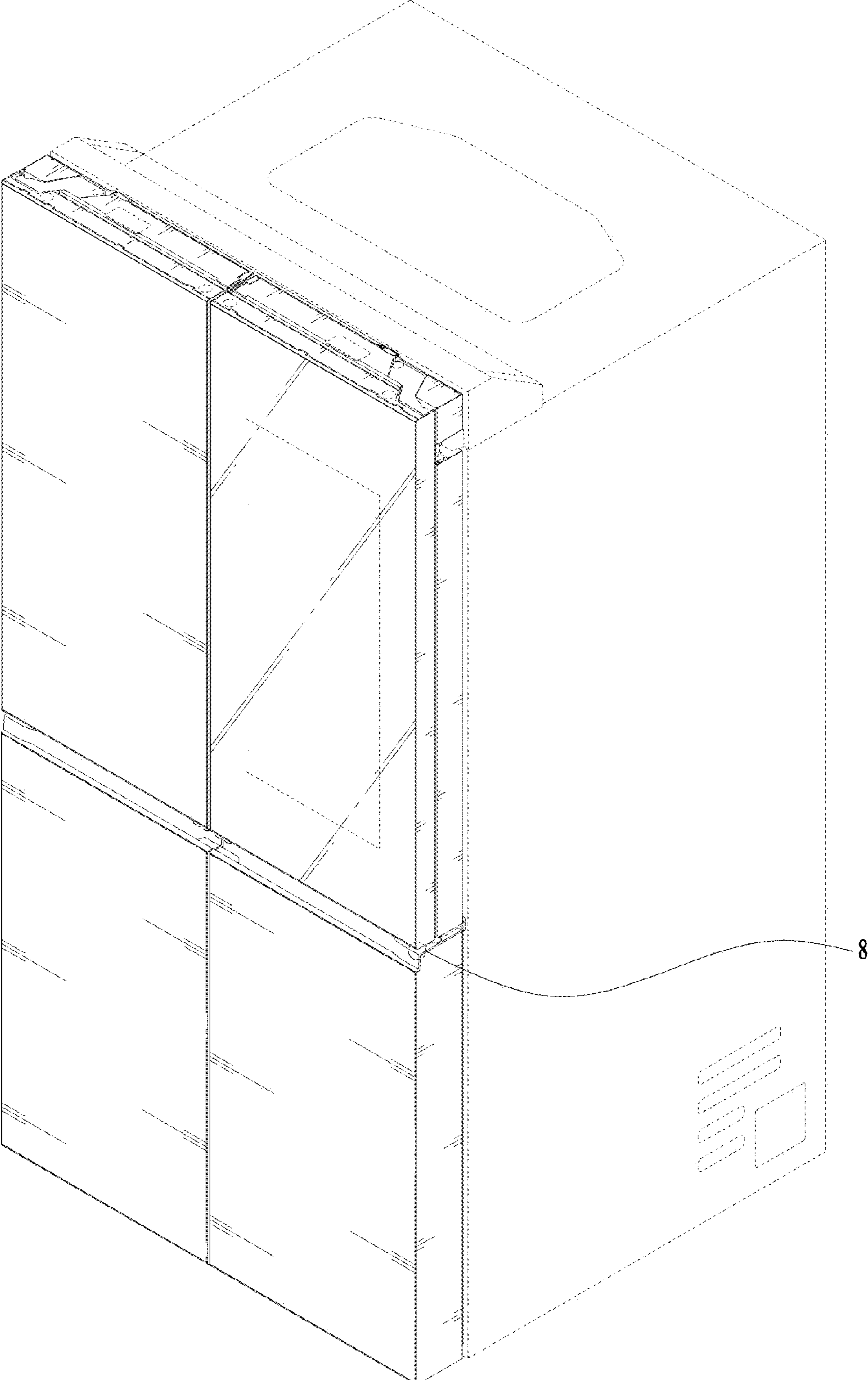

FIG. 2

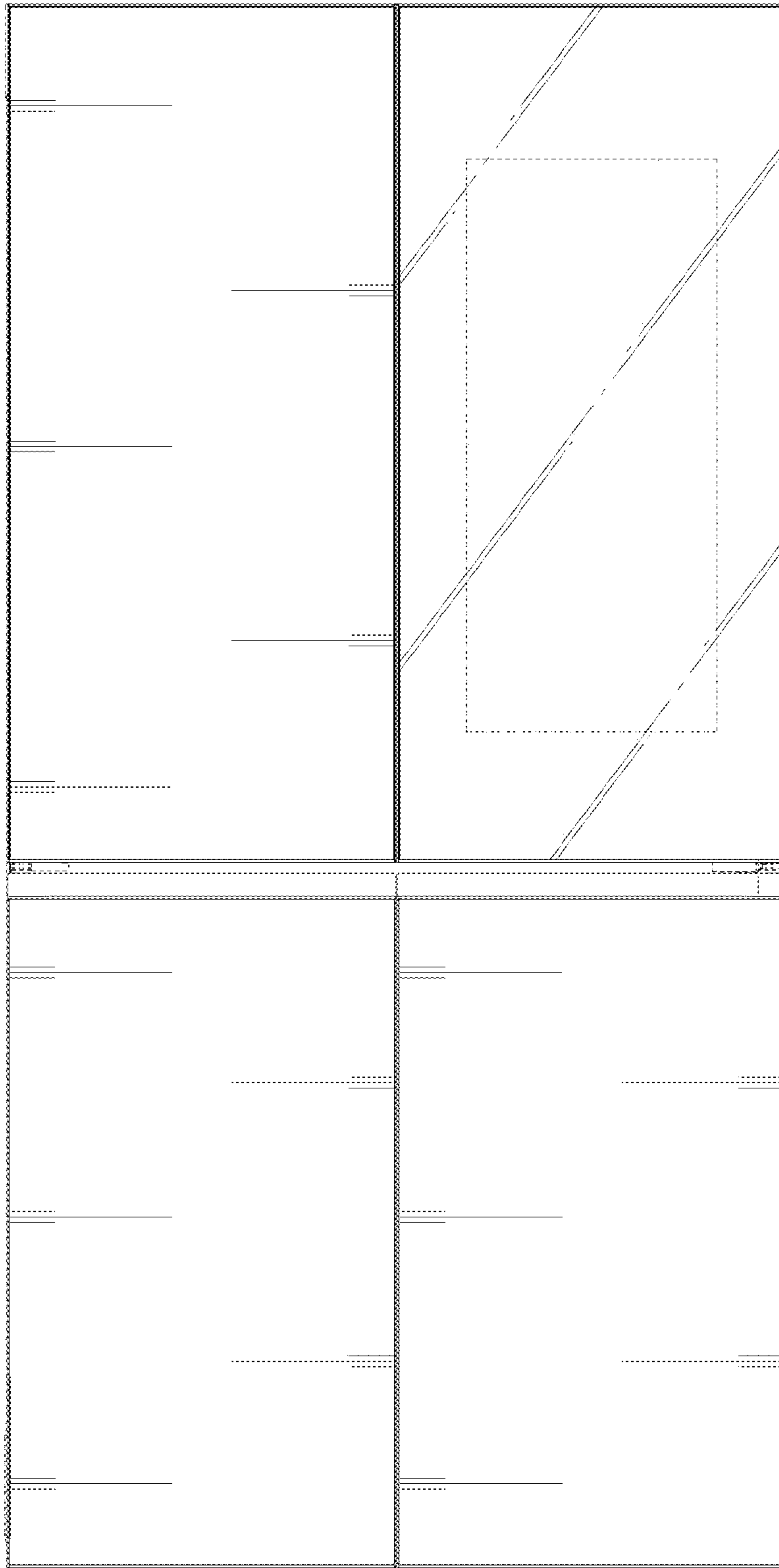

FIG. 3

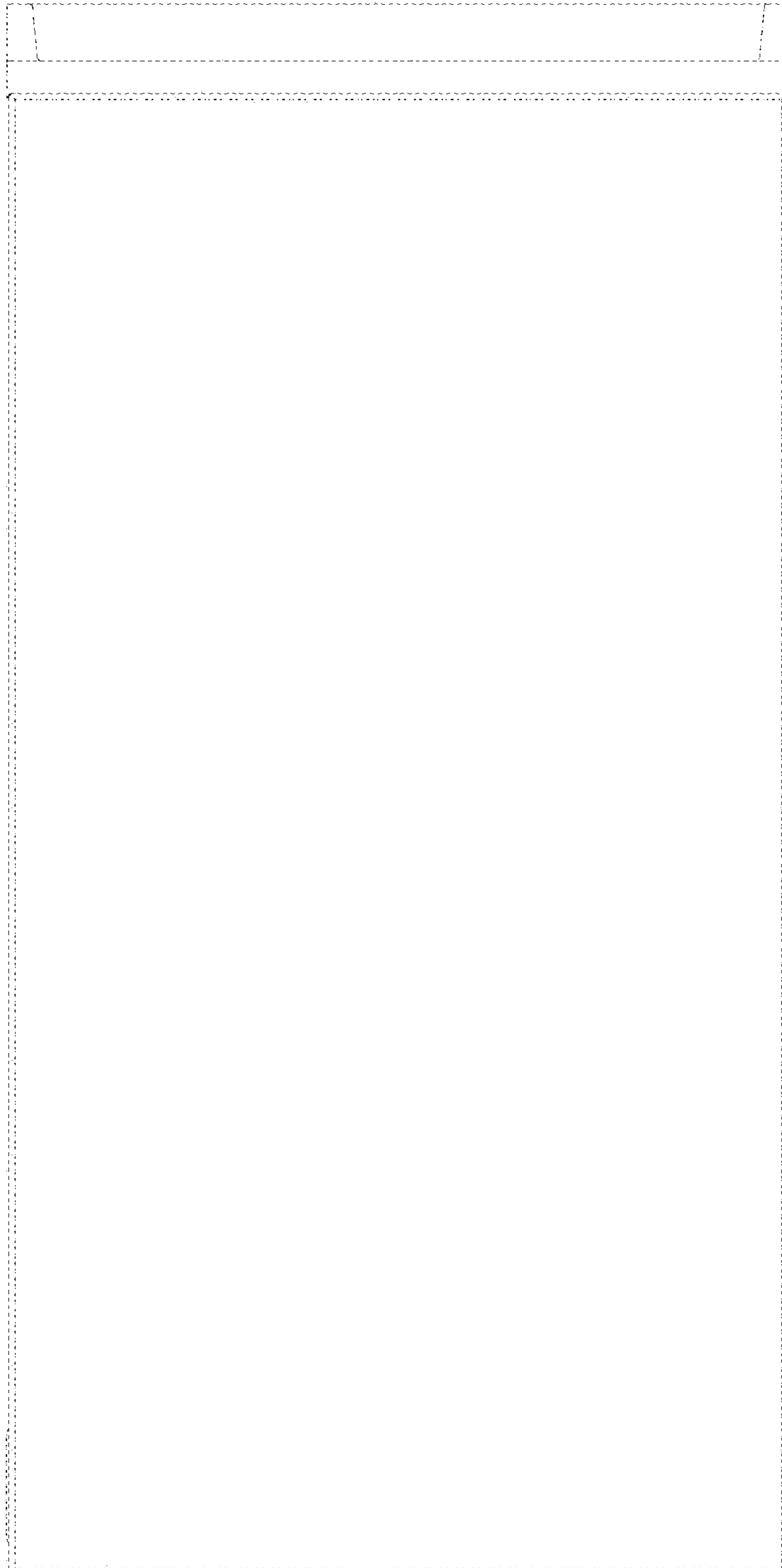

FIG. 4

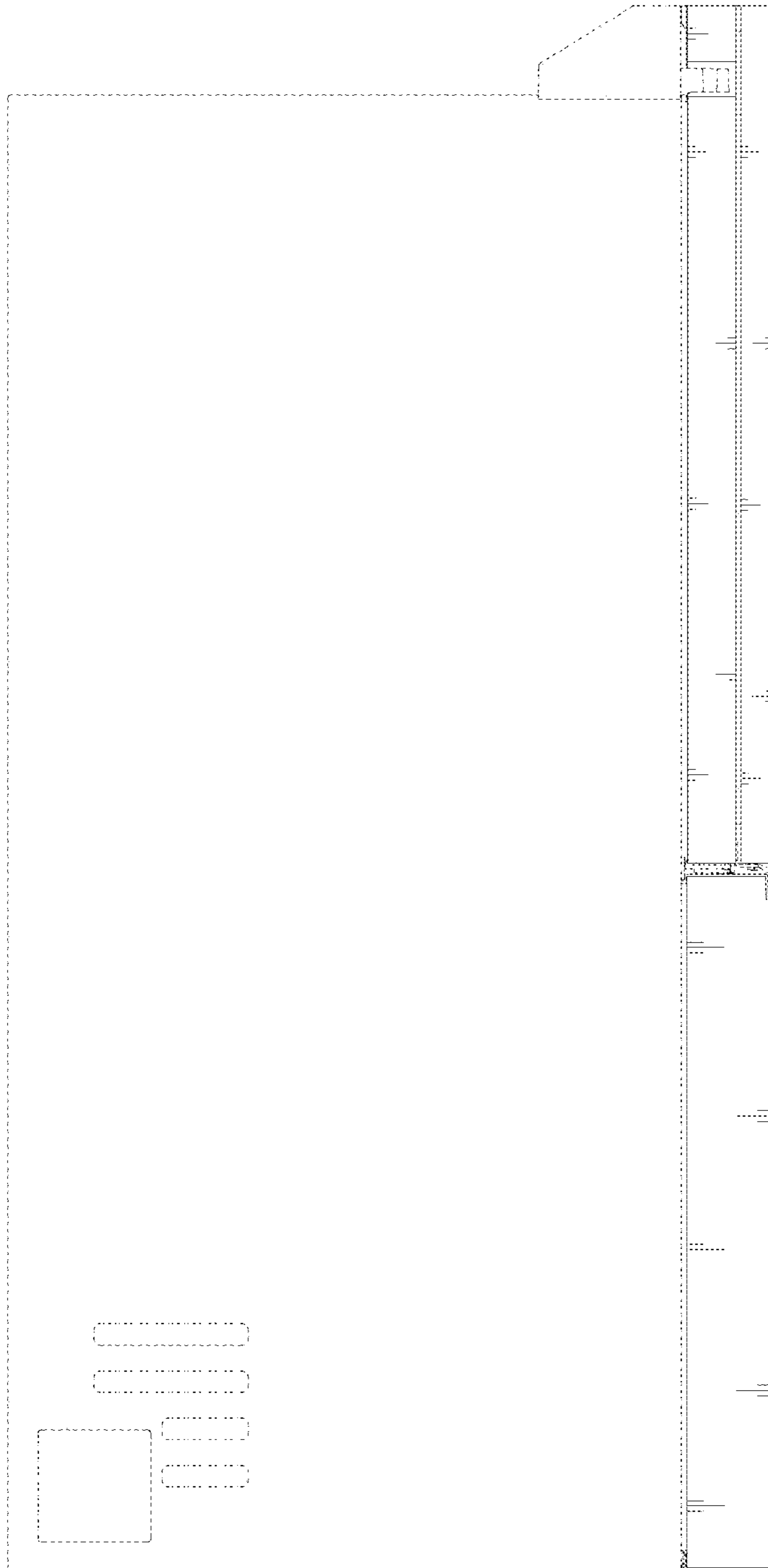

FIG. 5

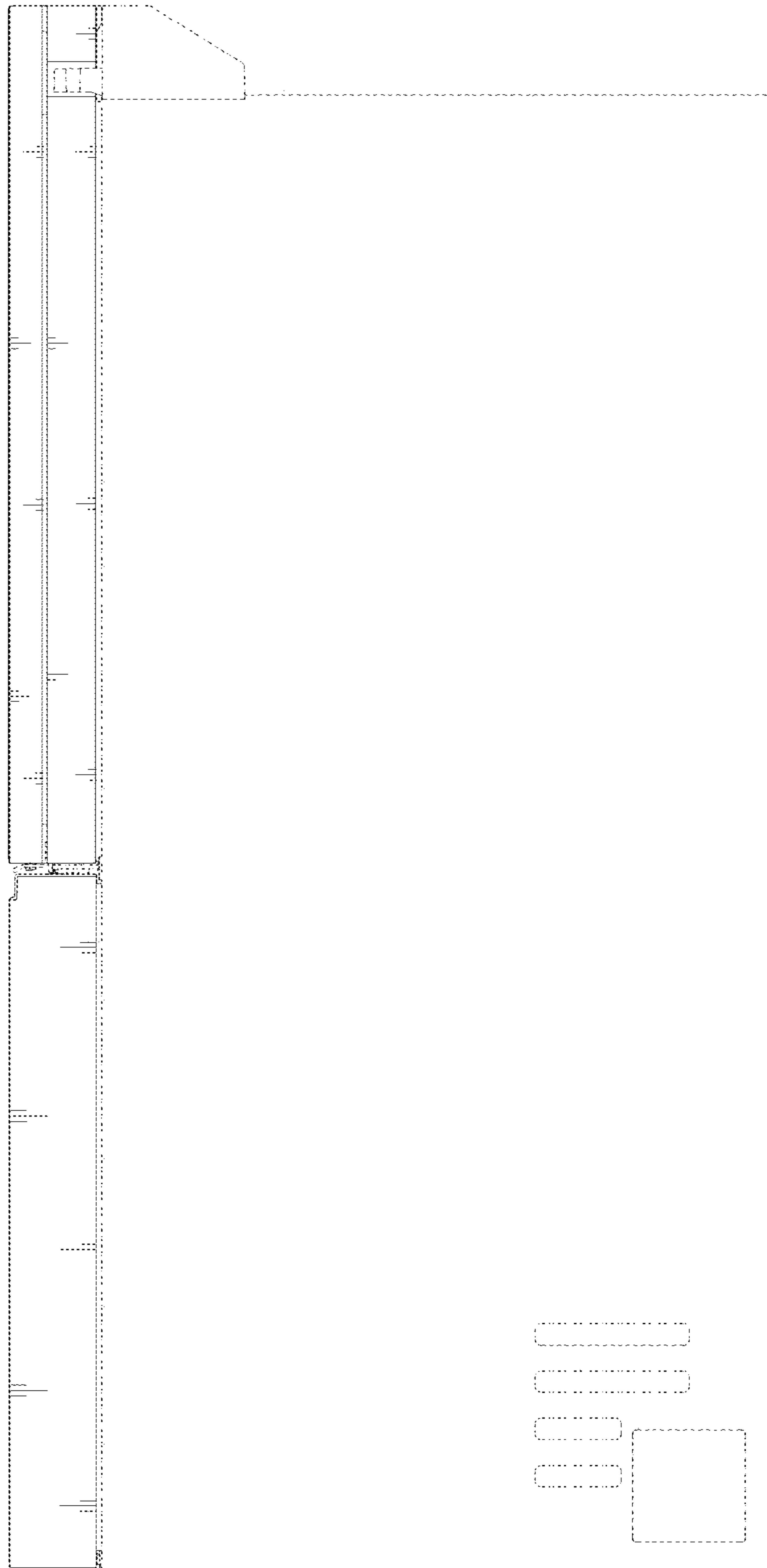

FIG. 6

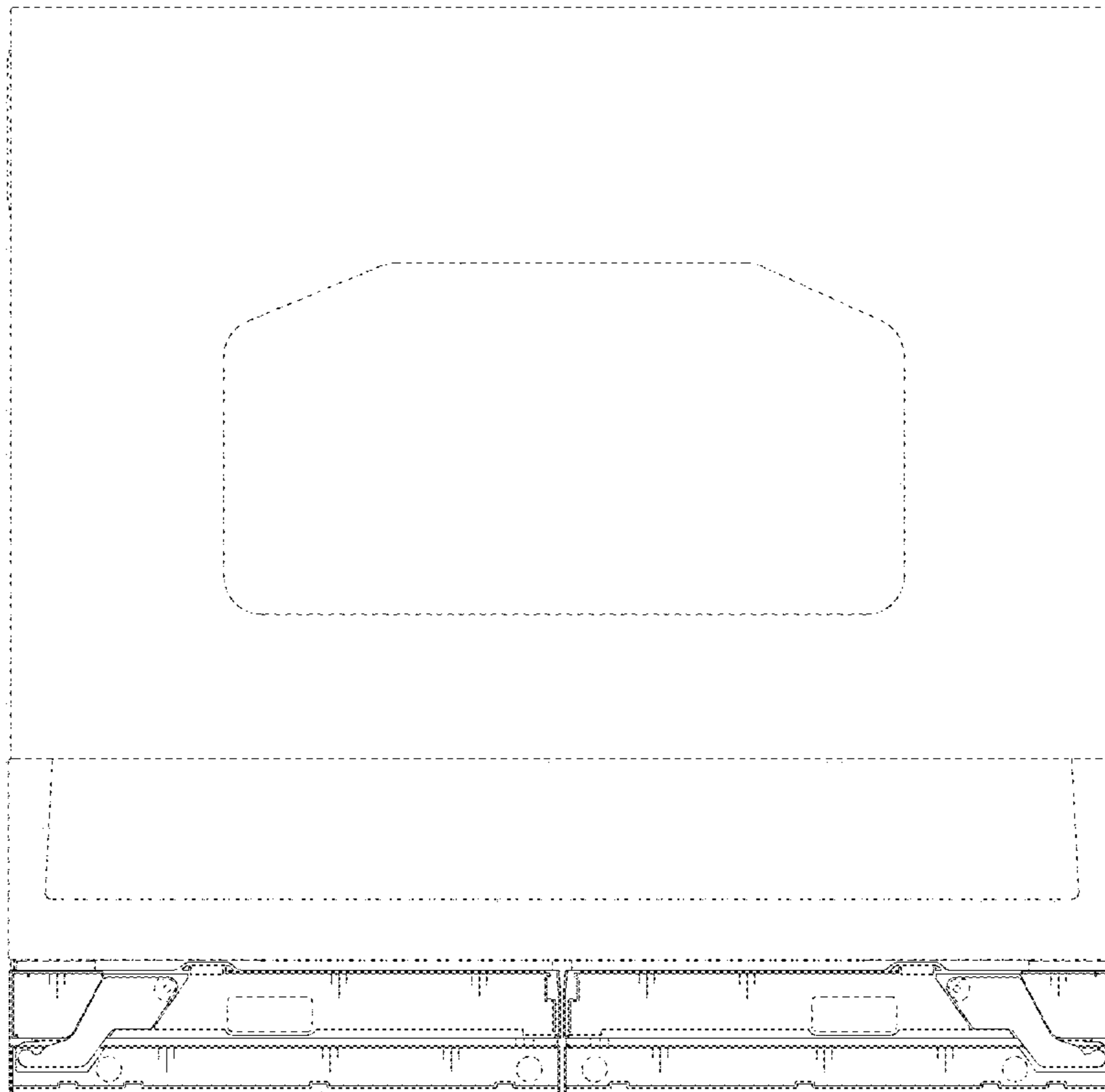



FIG. 7

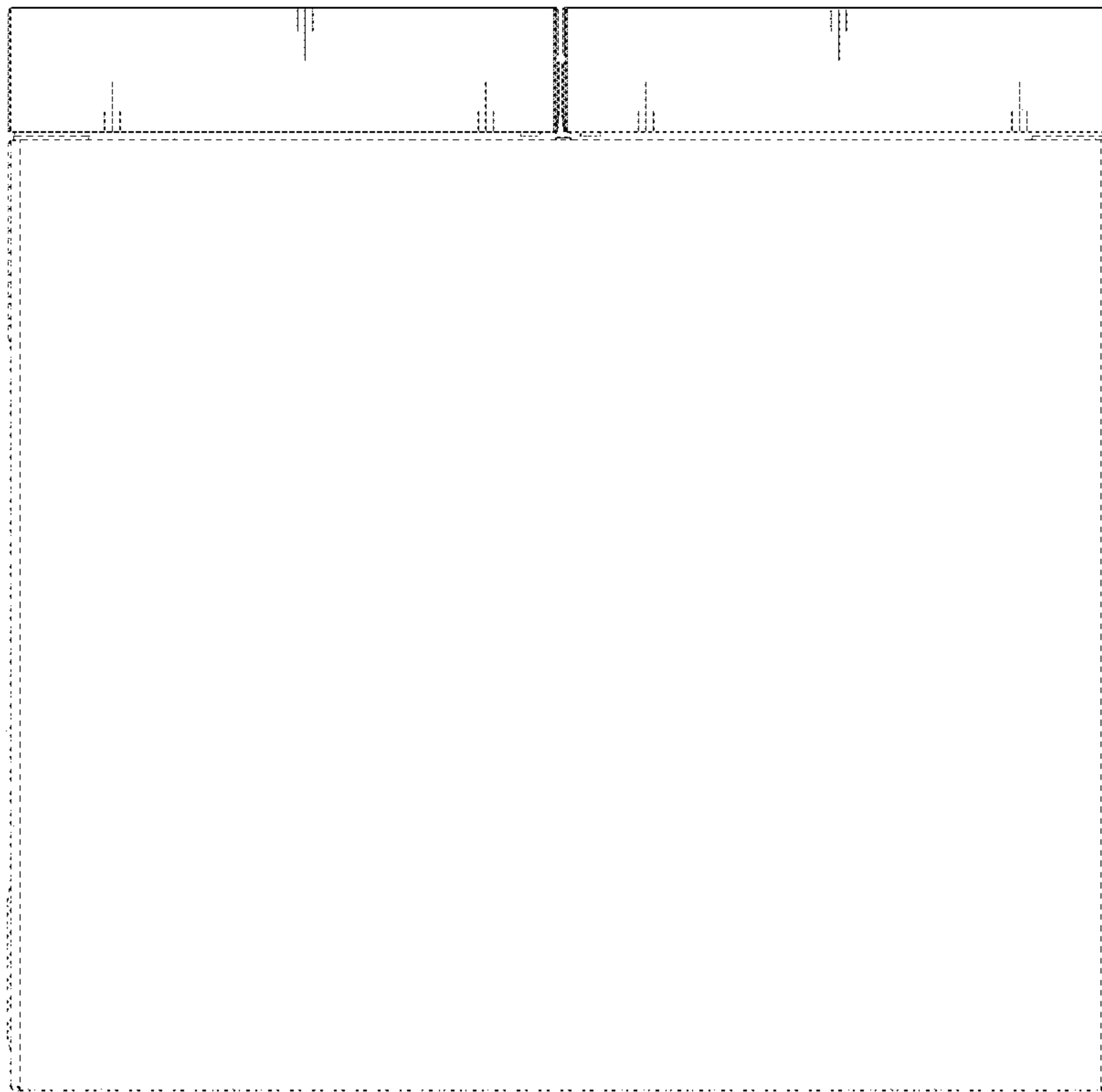

FIG. 8

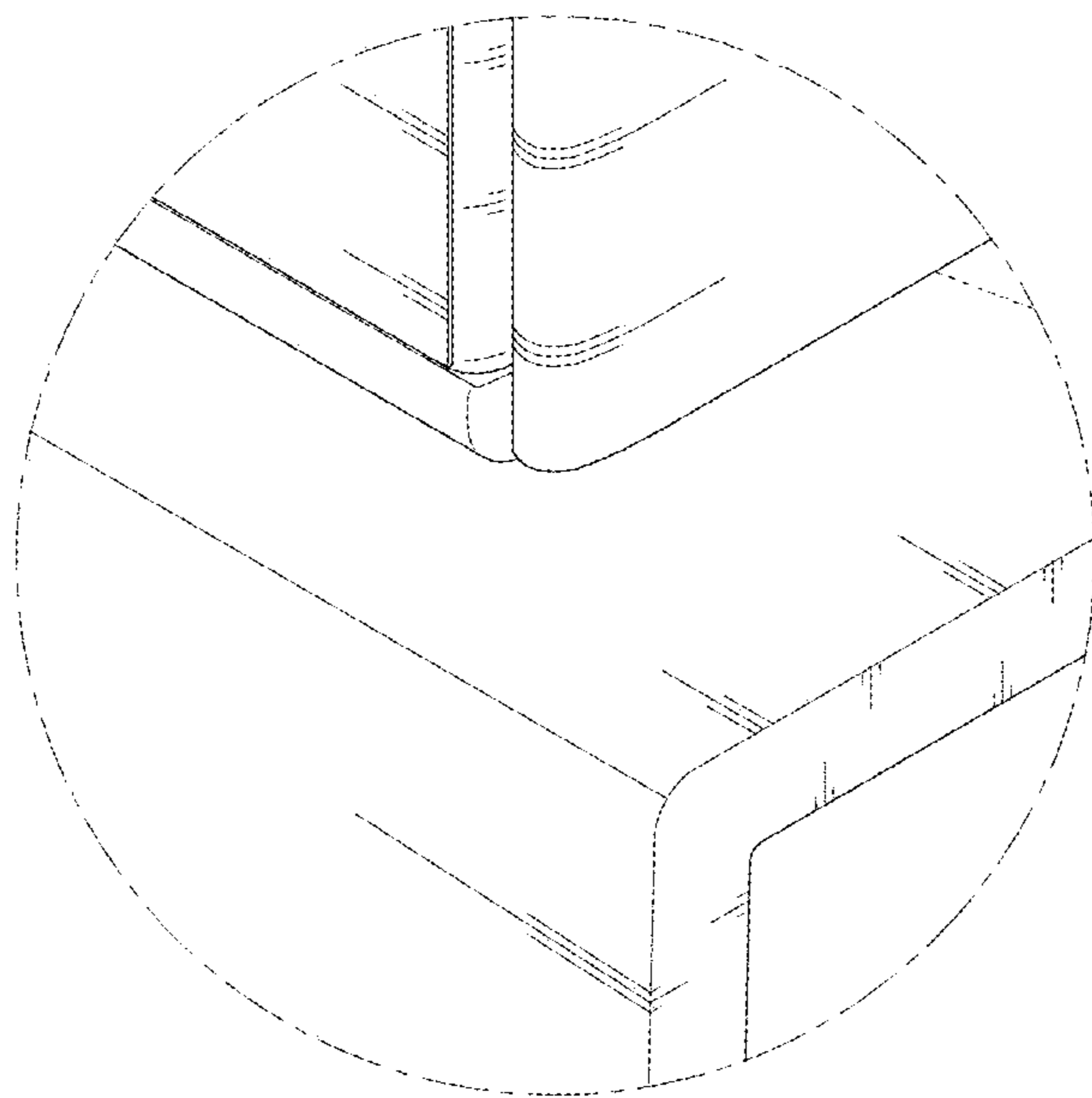

FIG. 9

