



US00D962239S

(12) **United States Design Patent** (10) **Patent No.:** **US D962,239 S**
Arenas de Jesus et al. (45) **Date of Patent:** **** Aug. 30, 2022**

(54) **PEDESTAL SCANNER**

(71) Applicant: **Amazon Technologies, Inc.**, Seattle, WA (US)

(72) Inventors: **Ana Maria Arenas de Jesus**, Seattle, WA (US); **Sara Elizabeth Stille**, Seattle, WA (US); **Spencer Ralph Dodge**, Covington, WA (US)

(73) Assignee: **Amazon Technologies, Inc.**, Seattle, WA (US)

(**) Term: **15 Years**

(21) Appl. No.: **29/747,201**

(22) Filed: **Aug. 20, 2020**

(51) **LOC (13) Cl.** **14-02**

(52) **U.S. Cl.**
USPC **D14/420**; D14/421; D14/453

(58) **Field of Classification Search**
USPC D14/421-425, 420, 434, 453; D18/55, D18/49, 46, 40, 36-39, 41, 44, 45, 47, D18/48, 50-54, 56; 235/462, 455, 470, 235/462.43, 482, 483, 462.21, 472.01, 235/435, 439, 440, 446, 454, 461, 462.32, 235/462.35, 462.41, 462.42, 463; 358/474, 486, 488, 496, 497, 498, 452, 358/449, 451, 453, 1.13; 318/685, 696; 355/81, 75; 399/405, 367, 379, 380; 382/217; 715/209, 222, 226, 274; 400/613, 613.1-613.4, 690.1-690.4, 400/691-694; D26/1-3, 24, 56, 72, D26/74-86, 88-91, 25; D13/180, 182; 362/150, 217.01-217.9, 217.1, 217.12, 362/217.13, 260, 364, 365, 366, 404, 555, 362/576, 800, 14, 148, 296.01
CPC .. D07G 1/0036; D07G 1/0045; D07G 1/0063; D07G 1/0072; D07G 1/009; G08B 13/1427; G08B 13/1472; G08B 13/1481; G08B 13/194; G08B 13/246; G08B 13/2462; G08B 13/2465; A47F 9/04;

A47F 9/046; A47F 9/047; A47F 9/048; A47F 10/02; A47F 2010/005; A47F 2010/025; G06K 7/10693; G06K 7/10712; G06K 7/10722; G06K 7/10792; G06K 7/10801; G06K 7/10811; G06K 7/10831; G06K 7/10851; G06K 7/10861; G06K 7/1096; G06K 7/1097; G06K 7/1098; G06K 7/12; G06K 7/14; G06K 7/1408; G06K 7/1413; G06K 7/1417; G06K 7/1421; G06K 7/1426; G06K 7/143; G06K 7/1434; G06K 7/1439; G06K 7/1443; G06K 7/1447; G06K
(Continued)

(56) **References Cited**

U.S. PATENT DOCUMENTS

D223,349 S * 4/1972 Minas D10/46
D268,150 S * 3/1983 Hauser D6/675.4
(Continued)

Primary Examiner — Susan Moon Lee
(74) *Attorney, Agent, or Firm* — Lee & Hayes, P.C.

(57) **CLAIM**

The ornamental design for a pedestal scanner, as shown and described.

DESCRIPTION

FIG. 1 is a top, front, left-side perspective view of a pedestal scanner;
FIG. 2 is a bottom, front, right-side perspective view thereof;
FIG. 3 is a front view thereof;
FIG. 4 is a back view thereof;
FIG. 5 is a left-side view thereof;
FIG. 6 is a right-side view thereof;
FIG. 7 is a top view thereof; and,
FIG. 8 is a bottom view thereof.
The dashed broken lines depict portions of the pedestal scanner that form no part of the claimed design.

1 Claim, 8 Drawing Sheets

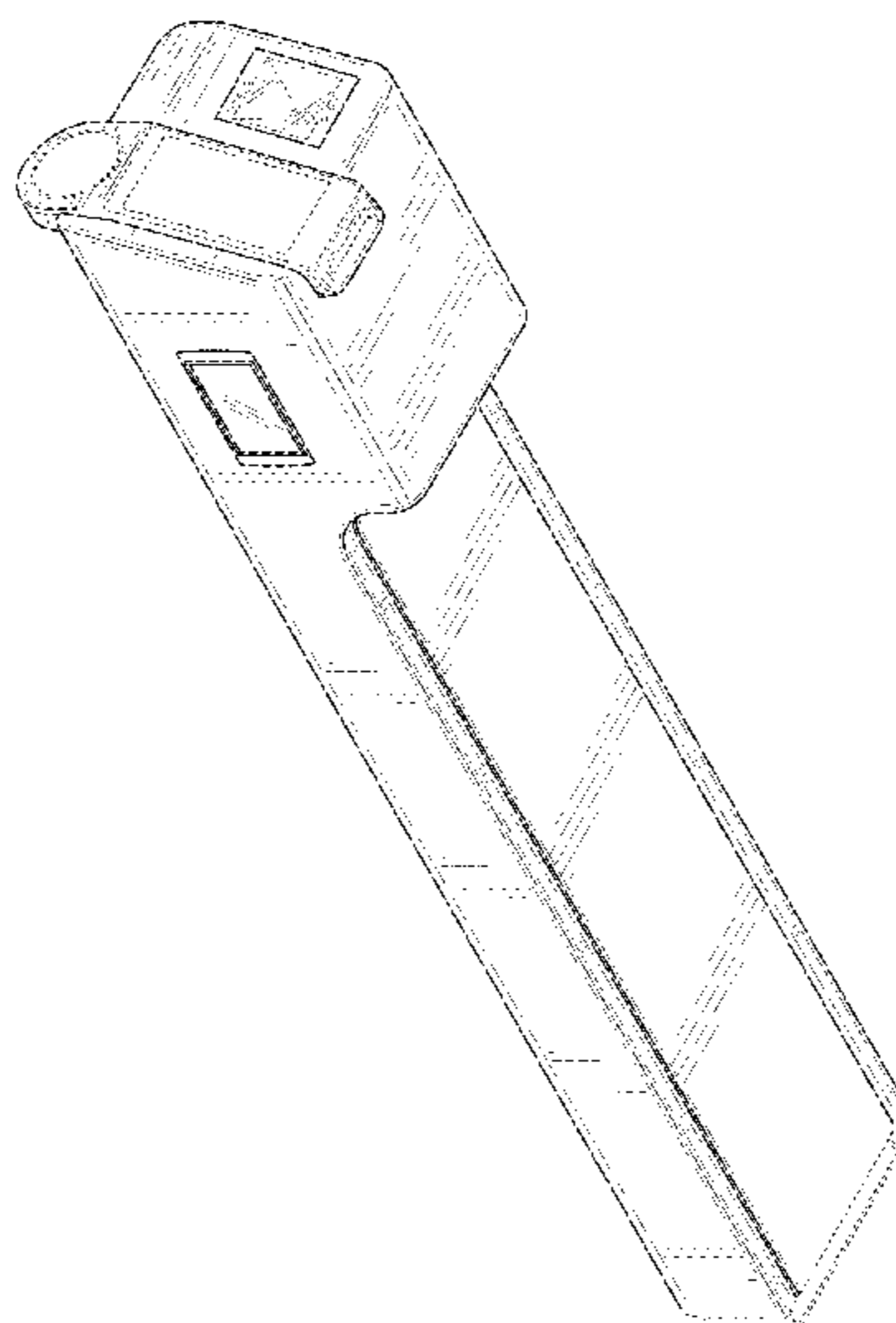

(58) **Field of Classification Search**

CPC 7/1452; G06K 7/1456; G06K 7/146; G06K 7/1465; G06K 7/1469; G06K 7/1473; G06K 7/1478; G06K 7/1482; G06K 7/1486; G06K 2007/10485; G06K 7/10544-10762; G06K 7/10821-10871; G06K 7/1404-1495; G06K 2207/00; G06K 2207/1011-1018; G01G 19/4144; G01G 21/22; G01G 21/28; G01G 23/32; G01G 23/34; G01G 23/35; G01G 23/375; G01G 23/38; G01G 23/44; G07G 1/0063; G07G 1/0072; G07G 3/006; G02B 5/09; G02B 6/00; G06T 2211/00; H04N 1/0313-032; H04N 1/02815-02895; H04N 1/0249; H04N 1/02481; H04N 1/00; H04N 1/12; H04N 1/00013; H04N 1/00015; H04N 1/00018; H04N 1/00026; H04N 1/00557; H04N 1/00564; H04N 1/00567; H04N 1/0057; H04N 1/00572; H04N 1/00586; H04N 1/00588; H04N 1/00591; H04N 1/00594; H04N 1/00596; H04N 1/00604; H04N 1/00519; H04N 1/00559; H04N 1/00551; H04N 1/00278; H04N 1/1013; H04N 1/10; H04N 5/2251-2256; H04N 2201/02456; H04N 2201/02458; H04N 2201/02462; H04N 2201/03468; H04N 2201/02485; H04N 2201/0249; H04N 2201/02481; H04N 2201/0456; H04N 2201/0446; H04N 2201/00; H04N 2201/0094; H01L 27/14618-14643; H01L 27/14649; H01L 27/14652; H01L 27/14658-1467; H01L 31/0232-02327; H01L 31/1055; H01L 31/14; G03G 15/0142; G03G 15/605; G03G 15/602; F21S 2/00; F21S 4/00; F21S 4/003; F21S 4/005; F21S 4/006; F21S 4/007; F21S 4/008; F21S 6/00; F21S 8/00; F21S 8/024; F21S 8/026; F21S 8/031; F21S 8/033; F21S 8/035-037; F21S 8/04; F21S 8/043; F21S 8/063

See application file for complete search history.

(56) **References Cited**

U.S. PATENT DOCUMENTS

D276,315 S * 11/1984 Collister D10/46
 D289,291 S * 4/1987 Kapper D14/389
 D299,028 S * 12/1988 Hermann D14/344
 D311,393 S * 10/1990 Weaver D14/420
 D315,337 S * 3/1991 Weaver D14/420
 D354,280 S * 1/1995 Fenton D14/137
 D355,173 S * 2/1995 Fenton D14/137
 5,808,289 A * 9/1998 Becker G06K 7/10891
 235/472.01
 5,844,228 A * 12/1998 Nukui G06K 7/1092
 200/332.2
 D411,202 S * 6/1999 Flanagan, III D14/459

D416,032 S * 11/1999 Bakshi D16/203
 D426,240 S * 6/2000 Senda D14/420
 D427,587 S * 7/2000 Jacobsen D14/240
 D444,787 S * 7/2001 Tsushima D14/420
 D518,482 S * 4/2006 Hodges D14/426
 D537,807 S * 3/2007 Griffin D14/155
 D544,462 S * 6/2007 Patel D14/155
 D565,577 S * 4/2008 Hanks D14/429
 D583,822 S * 12/2008 Matsumoto D14/453
 D585,066 S * 1/2009 Morris D14/453
 D605,588 S * 12/2009 Nomi D13/108
 D621,834 S * 8/2010 Kinno D14/383
 D640,249 S * 6/2011 Choi D14/253
 D655,298 S * 3/2012 Xu D14/453
 D680,491 S * 4/2013 Paschke D13/108
 D688,804 S * 8/2013 Kim D24/216
 D691,732 S * 10/2013 Shibata D24/216
 D693,348 S * 11/2013 Min D14/426
 D693,815 S * 11/2013 Son D14/434
 D697,917 S * 1/2014 Sato D14/421
 D699,368 S * 2/2014 Quilter D24/186
 D715,284 S * 10/2014 Iwamoto D12/415
 D717,308 S * 11/2014 Knoll D14/453
 D717,799 S * 11/2014 Lee D14/420
 D719,166 S * 12/2014 Brown D14/420
 D719,167 S * 12/2014 Brown D14/420
 D724,088 S * 3/2015 Giometti D14/420
 D727,327 S * 4/2015 Quilter D14/420
 D727,901 S * 4/2015 Nishimura D14/383
 9,041,347 B2 * 5/2015 Paschke F16M 13/00
 320/108
 D736,755 S * 8/2015 Kwak D14/248
 D750,513 S * 3/2016 King D10/70
 D752,051 S * 3/2016 Chen D14/434
 D752,240 S * 3/2016 Chan D24/216
 D754,600 S * 4/2016 Lin D13/110
 D769,186 S * 10/2016 Yang D13/108
 D787,506 S * 5/2017 Takiguchi D14/341
 D787,508 S * 5/2017 Takiguchi D14/341
 D788,778 S * 6/2017 Magi D14/434
 D807,213 S * 1/2018 Williams G01N 21/75
 D24/186
 D815,097 S * 4/2018 Magi D14/434
 D817,959 S * 5/2018 Varotto D14/383
 D825,567 S * 8/2018 Behrooznia D14/420
 D829,718 S * 10/2018 Fletcher D14/434
 10,176,350 B1 * 1/2019 Schwalbe G06F 13/4286
 D849,833 S * 5/2019 Eun D18/12
 D850,366 S * 6/2019 Zou D13/108
 D895,841 S * 9/2020 Mathers D24/232
 D921,222 S * 6/2021 Osborne D24/232
 D928,082 S * 8/2021 Houghton D13/107
 D933,662 S * 10/2021 Minnis D14/453
 D937,266 S * 11/2021 Stille D14/453
 2003/0111530 A1 * 6/2003 Iki G07B 15/00
 235/382
 2007/0286646 A1 * 12/2007 Ichikawa G03G 15/0875
 399/262
 2009/0269841 A1 * 10/2009 Wojciechowski C12M 41/26
 435/303.1
 2013/0057927 A1 * 3/2013 Durant H04N 1/00541
 358/474
 2017/0091379 A1 * 3/2017 Vickers B01L 3/502
 2017/0091380 A1 * 3/2017 Vickers G16H 50/30
 2017/0184585 A1 * 6/2017 Markovsky G01N 33/558

* cited by examiner

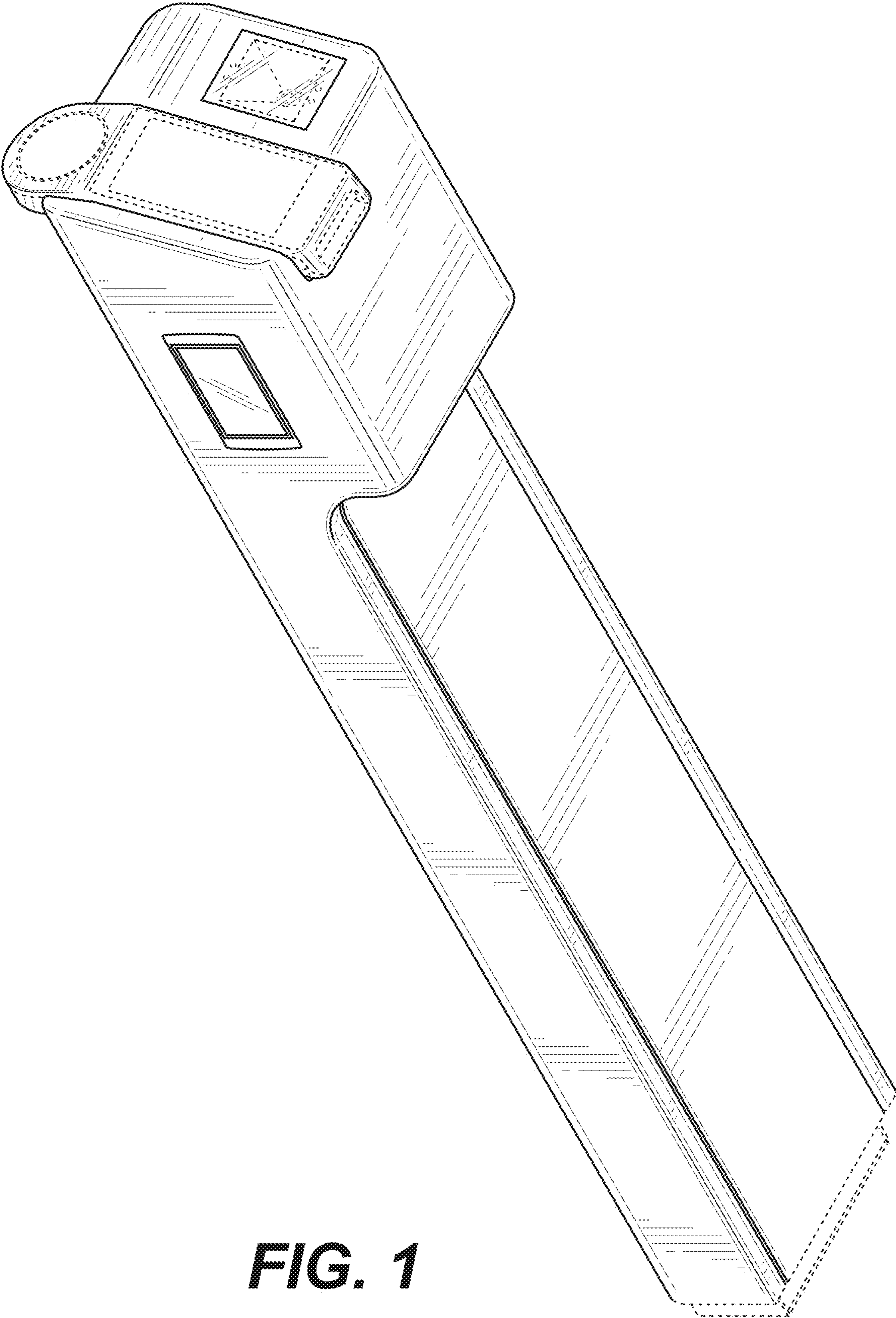

FIG. 1

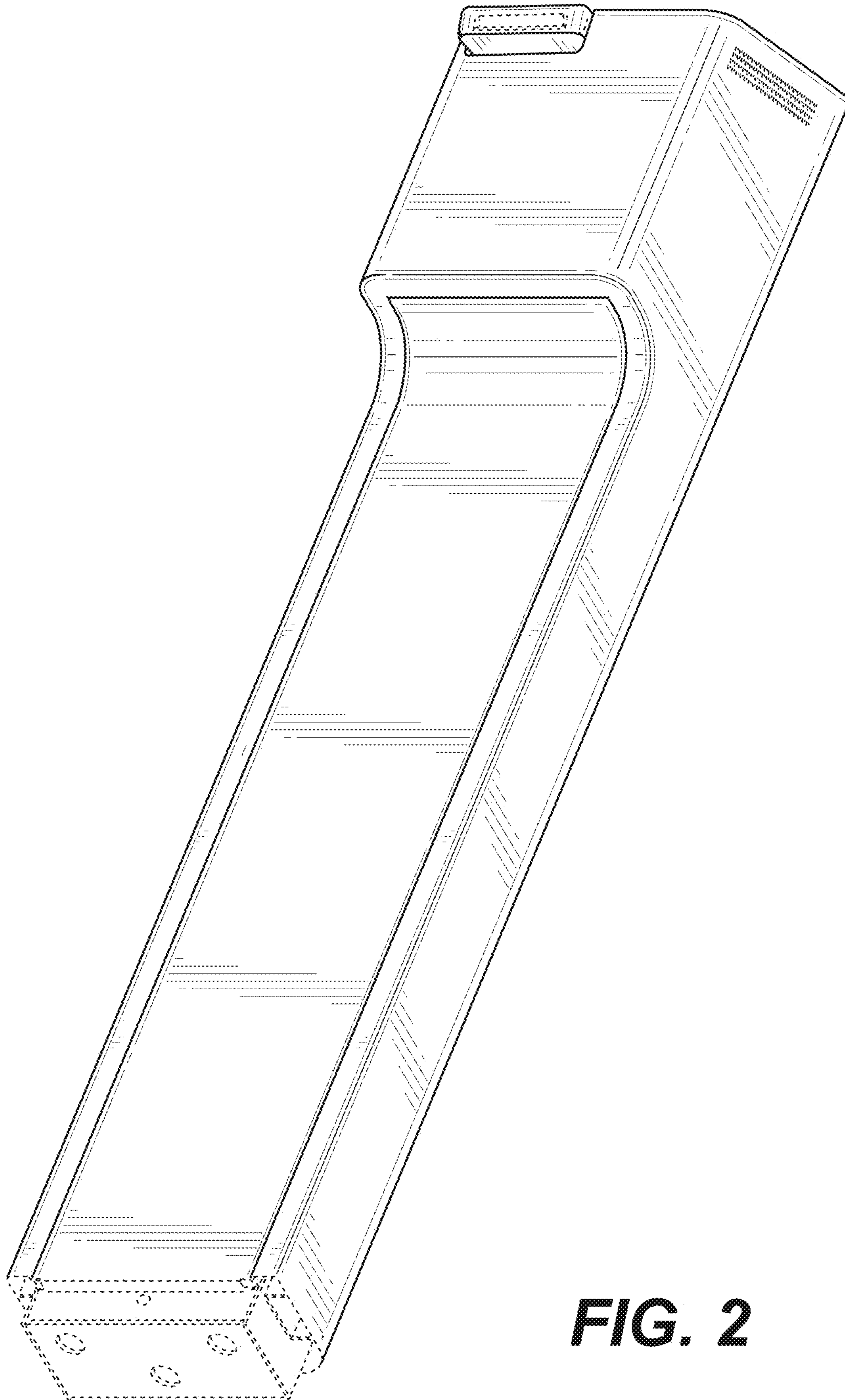

FIG. 2

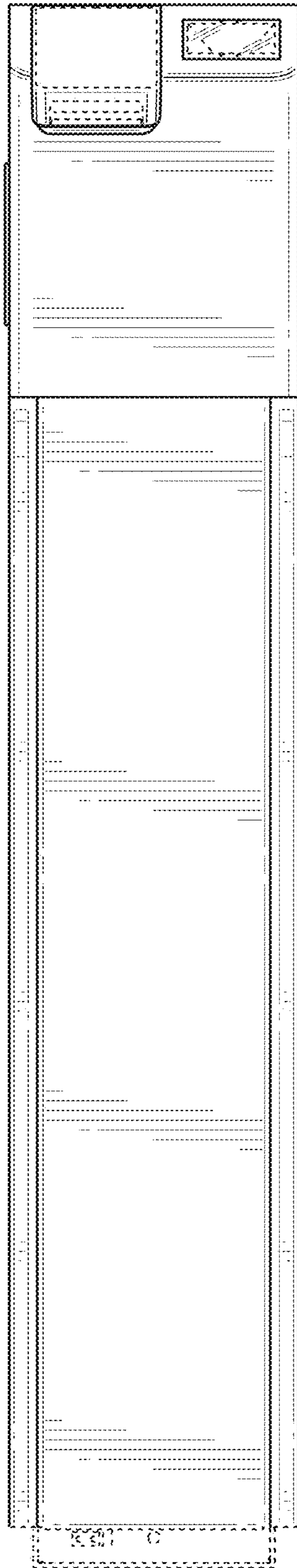

FIG. 3

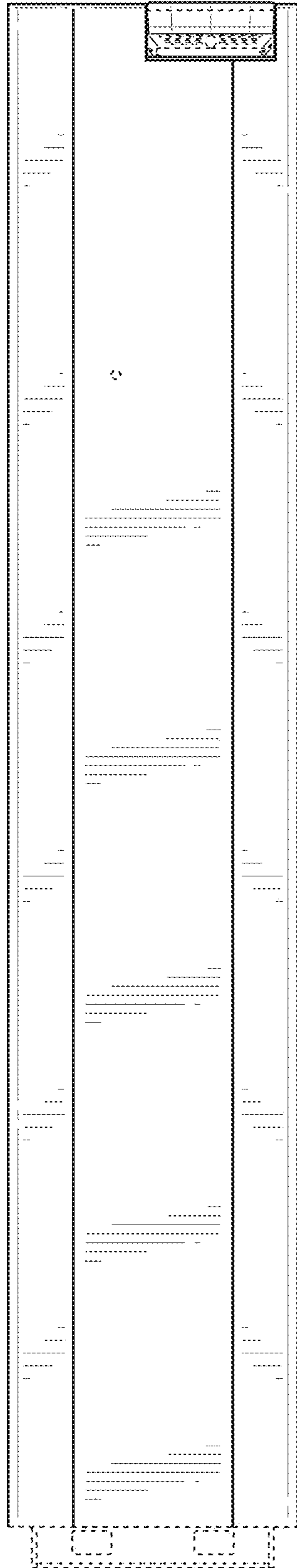

FIG. 4

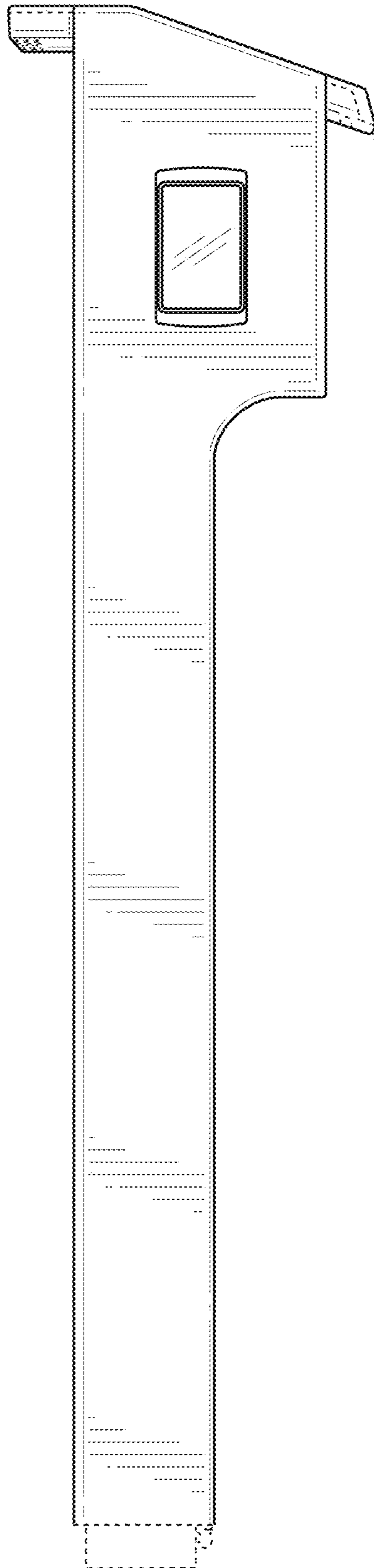

FIG. 5

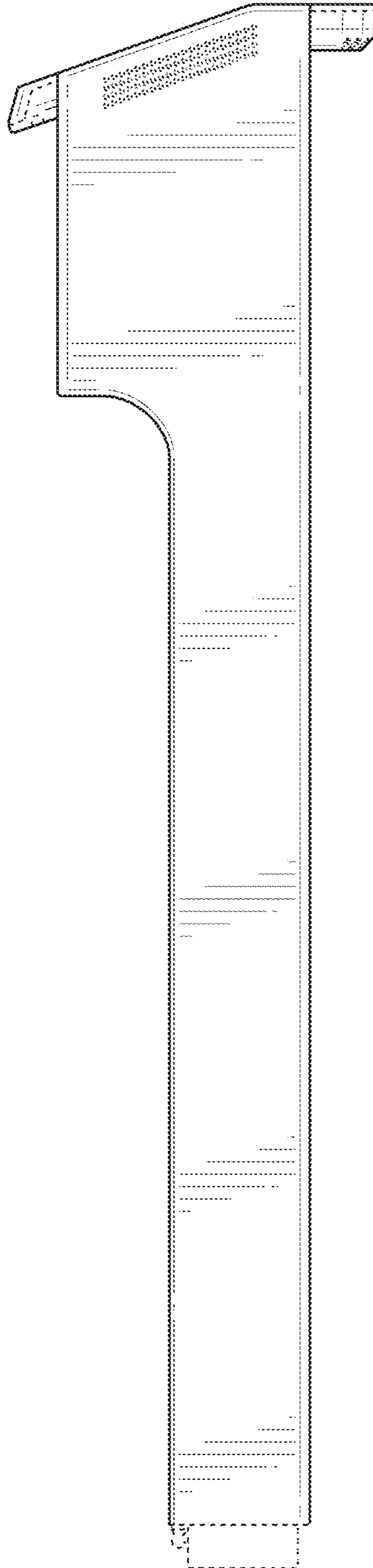

FIG. 6

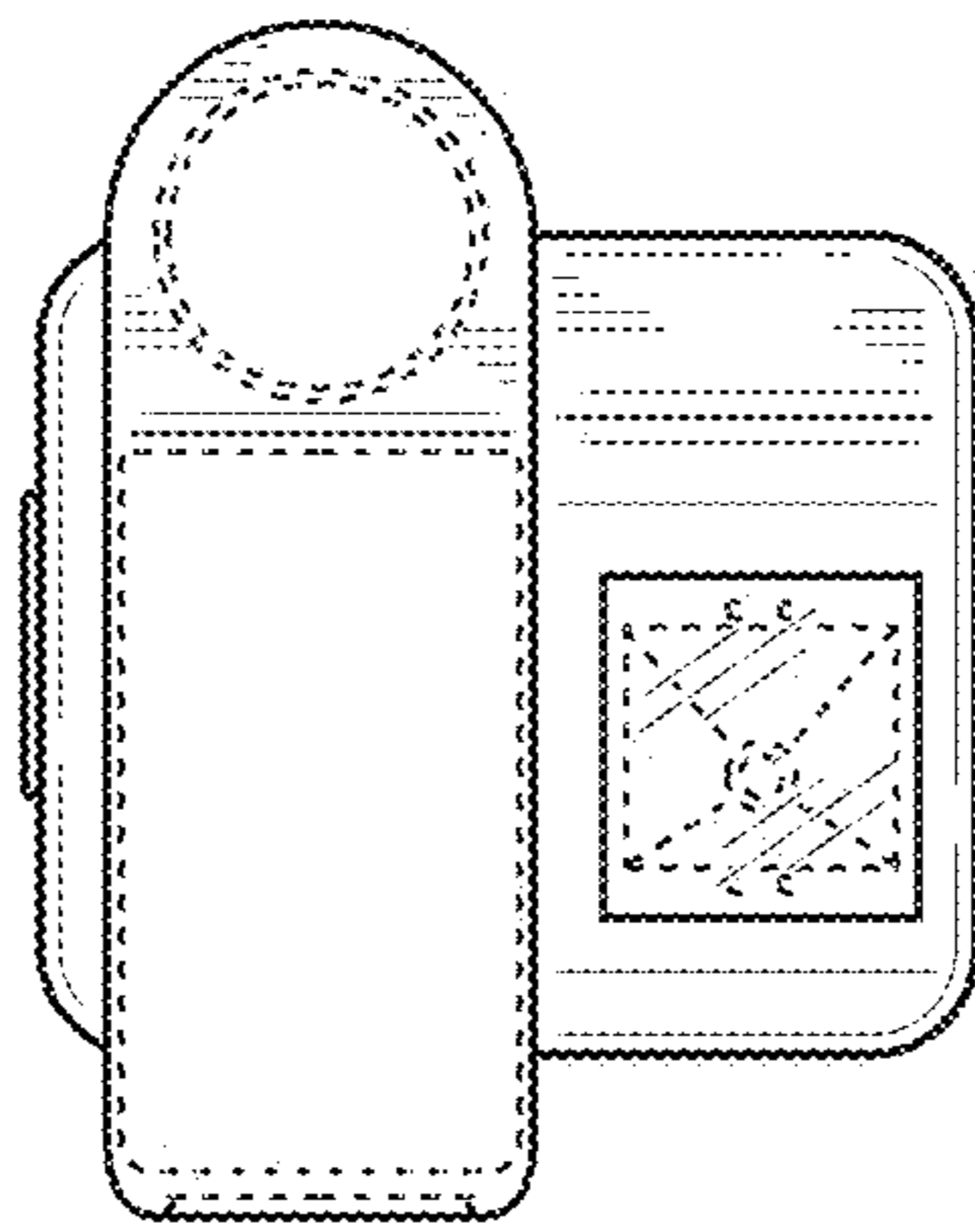

FIG. 7

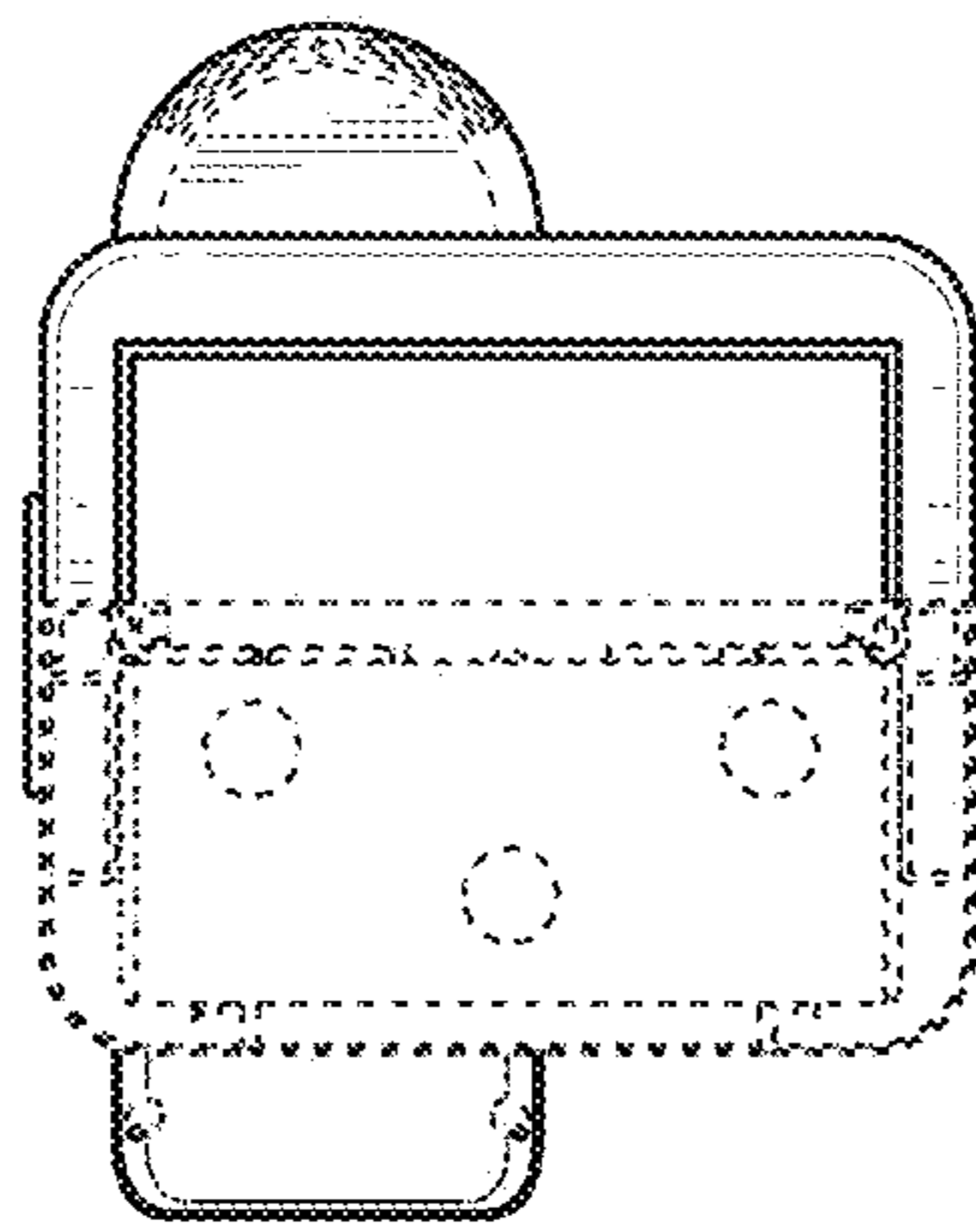

FIG. 8