



US00D962201S

(12) **United States Design Patent**  
**Jang et al.**

(10) **Patent No.:** **US D962,201 S**  
(45) **Date of Patent:** **\*\* Aug. 30, 2022**

(54) **EARPHONE**

(71) Applicant: **Samsung Electronics Co., Ltd.**,  
Suwon-si (KR)

(72) Inventors: **Youngsang Jang**, Suwon-si (KR);  
**Yongseok Bang**, Suwon-si (KR)

(73) Assignee: **Samsung Electronics Co., Ltd.**,  
Suwon-si (KR)

(\*\*) Term: **15 Years**

(21) Appl. No.: **29/752,539**

(22) Filed: **Sep. 28, 2020**

(30) **Foreign Application Priority Data**

May 15, 2020 (KR) ..... 30-2020-0021340

(51) **LOC (13) Cl.** ..... **14-01**

(52) **U.S. Cl.**  
USPC ..... **D14/223**; D14/217

(58) **Field of Classification Search**  
USPC ..... D14/223, 205, 217, 188, 192; D24/174;  
128/864-866; 381/380, 381, 378-379;  
455/90.3, 575.1, 569.1  
CPC ..... G06F 3/16; H04R 25/00; H04R 25/02;  
H04R 1/1016; H04R 1/1066; H04R  
5/033; H04R 5/0335; H04R 1/1091  
See application file for complete search history.

(56) **References Cited**

**U.S. PATENT DOCUMENTS**

1,853,130 A \* 4/1932 Leopold, Jr. .... B29D 30/0649  
425/451  
4,617,429 A \* 10/1986 Bellafiore ..... H04R 25/658  
264/222

(Continued)

**FOREIGN PATENT DOCUMENTS**

CN 2018304683425 7/2019  
CN 2019304736658 2/2020

(Continued)

**OTHER PUBLICATIONS**

““Peanuts, peanuts . . . ” Samsung had new Bluetooth earphones,  
jackpot features” [2020] www.wikitree.co.kr Apr. 9, 2020 <<https://www.wikitree.co.kr/articles/522208>>.

(Continued)

*Primary Examiner* — Paula Allen Greene

(74) *Attorney, Agent, or Firm* — NSIP Law

(57) **CLAIM**

We claim the ornamental design for an earphone, as shown  
and described.

**DESCRIPTION**

FIG. 1 is a front perspective view of an earphone showing  
our new design according to a first embodiment;  
FIG. 2 is a front view thereof;  
FIG. 3 is a rear view thereof;  
FIG. 4 is a left-side view thereof;  
FIG. 5 is a right-side view thereof;  
FIG. 6 is a top view thereof;  
FIG. 7 is a bottom view thereof;  
FIG. 8 is a rear perspective view thereof;  
FIG. 9 is a front perspective view of an earphone showing  
our new design according to a second embodiment;  
FIG. 10 is a front view thereof;  
FIG. 11 is a rear view thereof;  
FIG. 12 is a left-side view thereof;  
FIG. 13 is a right-side view thereof;  
FIG. 14 is a top view thereof;  
FIG. 15 is a bottom view thereof; and,  
FIG. 16 is a rear perspective view thereof.  
The broken lines in the figures depict portions of the  
earphone which form no part of the claimed design.

**1 Claim, 16 Drawing Sheets**

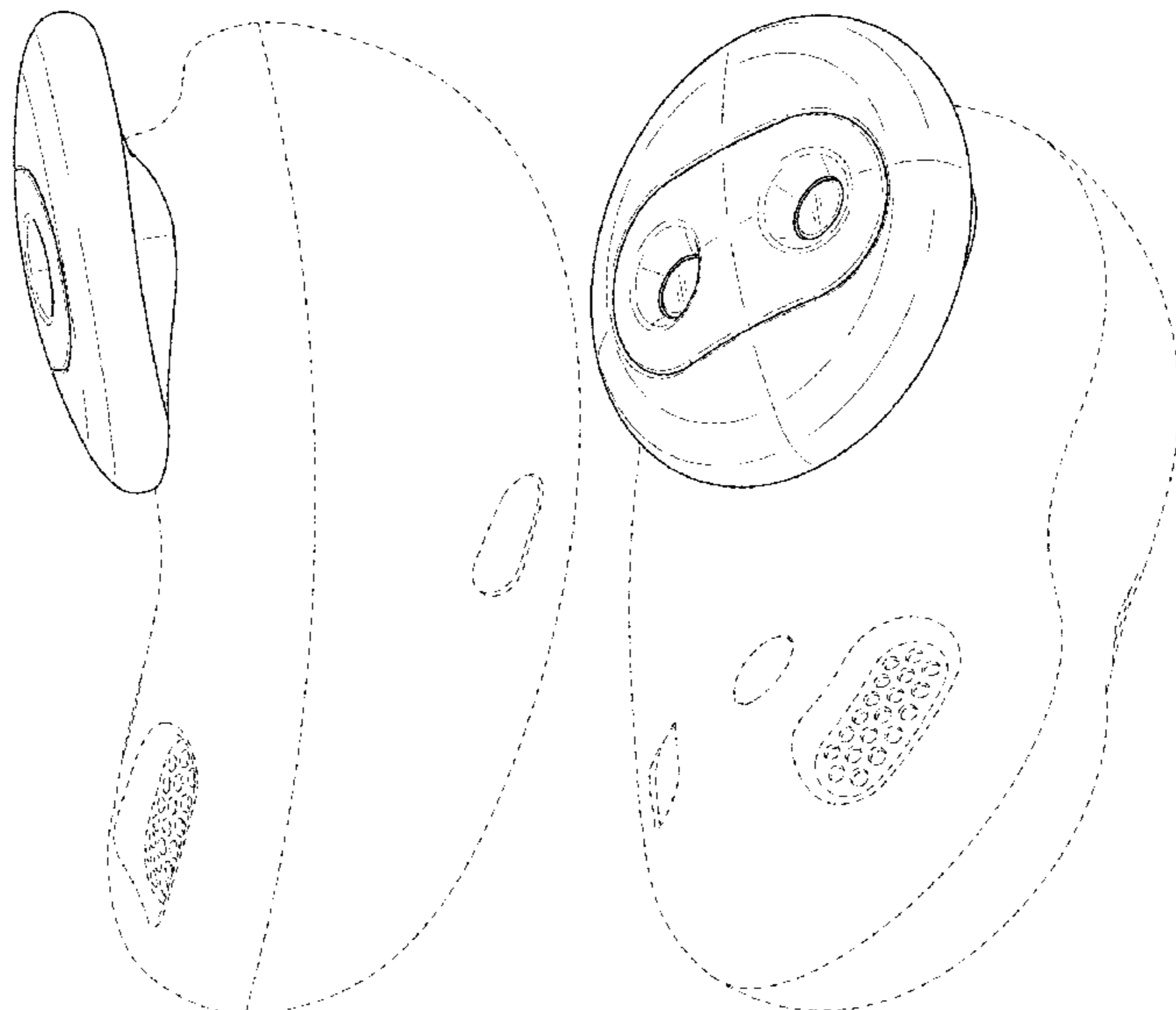

(56)

References Cited

U.S. PATENT DOCUMENTS

D287,764 S \* 1/1987 Topholm ..... D24/174  
 4,712,245 A \* 12/1987 Lyregaard ..... H04R 25/656  
 381/328  
 4,716,985 A \* 1/1988 Haertl ..... H04R 25/658  
 381/328  
 5,185,802 A \* 2/1993 Stanton ..... H04R 25/60  
 381/328  
 D397,796 S \* 9/1998 Yabe ..... D24/174  
 D412,987 S \* 8/1999 Borowsky ..... D24/173  
 D512,417 S \* 12/2005 Hirakawa ..... D14/223  
 D542,282 S \* 5/2007 Yoshiyama ..... D14/223  
 D554,756 S \* 11/2007 Sjursen ..... D24/174  
 7,356,362 B2 \* 4/2008 Chang ..... H04R 1/1033  
 381/372  
 D568,290 S \* 5/2008 Wikel ..... D14/205  
 7,492,917 B2 \* 2/2009 Ito ..... H04R 1/10  
 381/381  
 D603,380 S \* 11/2009 Hutchieson ..... D14/223  
 D728,107 S \* 4/2015 Torres Martin ..... D24/174  
 D805,060 S \* 12/2017 Loermann ..... D14/223  
 D806,879 S \* 1/2018 Horbinski ..... D24/174  
 D822,645 S \* 7/2018 Loermann ..... D14/223  
 D823,835 S \* 7/2018 Loermann ..... D14/223  
 D824,371 S \* 7/2018 Loermann ..... D24/174  
 D836,089 S \* 12/2018 Loermann ..... D14/223  
 D847,126 S \* 4/2019 Loermann ..... D14/223  
 D885,372 S \* 5/2020 Wang ..... D14/223  
 D887,394 S \* 6/2020 Zhang ..... D14/223  
 D895,580 S \* 9/2020 Yu ..... D14/223

10,827,249 B1 \* 11/2020 Pine ..... H04R 1/1041  
 D904,349 S \* 12/2020 Saxton ..... D14/223  
 D906,292 S \* 12/2020 Wang ..... D14/223  
 D925,492 S \* 7/2021 Sugiura ..... D14/223  
 D927,466 S \* 8/2021 Zhang ..... D14/223  
 D940,108 S \* 1/2022 Wu ..... D14/223  
 D941,278 S \* 1/2022 Laffon de Mazieres .... D14/223  
 2018/0014104 A1 \* 1/2018 Boesen ..... H04R 1/1016  
 2018/0060031 A1 \* 3/2018 Boesen ..... A61B 5/6803

FOREIGN PATENT DOCUMENTS

EM 007956149-0001 \* 5/2020  
 JP D1618141 11/2018  
 JP D1630631 5/2019

OTHER PUBLICATIONS

Wayl. "Bean X Bluetooth 5.0 True Wireless Sport Earbuds for Running Headphones, Best for Workout, Long Lasting 6-8hr Playtime, TWS Stereo Plus Deep Bass, Sweatproof, Built in Microphone Earphones" [2019] [www.amazon.com Jun. 26, 2019 <https://www.amazon.com/Bean-True-Wireless-Earbuds-Microphones/dp/B07L45W1YB>](https://www.amazon.com/Bean-True-Wireless-Earbuds-Microphones/dp/B07L45W1YB).

1MORE Store. "1MORE Stylish True Wireless Earbuds, Bluetooth 5.0, 24-Hour Playtime, Stereo In-Ear Headphones with Charging Case, Built-in Microphone, Alternate Pairing Mode" [2019] [www.amazon.com Apr. 3, 2019 <https://www.amazon.com/1MORE-Stylish-Wireless-Earbuds-Built/dp/B07M6LP3F9?th=1>](https://www.amazon.com/1MORE-Stylish-Wireless-Earbuds-Built/dp/B07M6LP3F9?th=1).

\* cited by examiner

FIG. 1

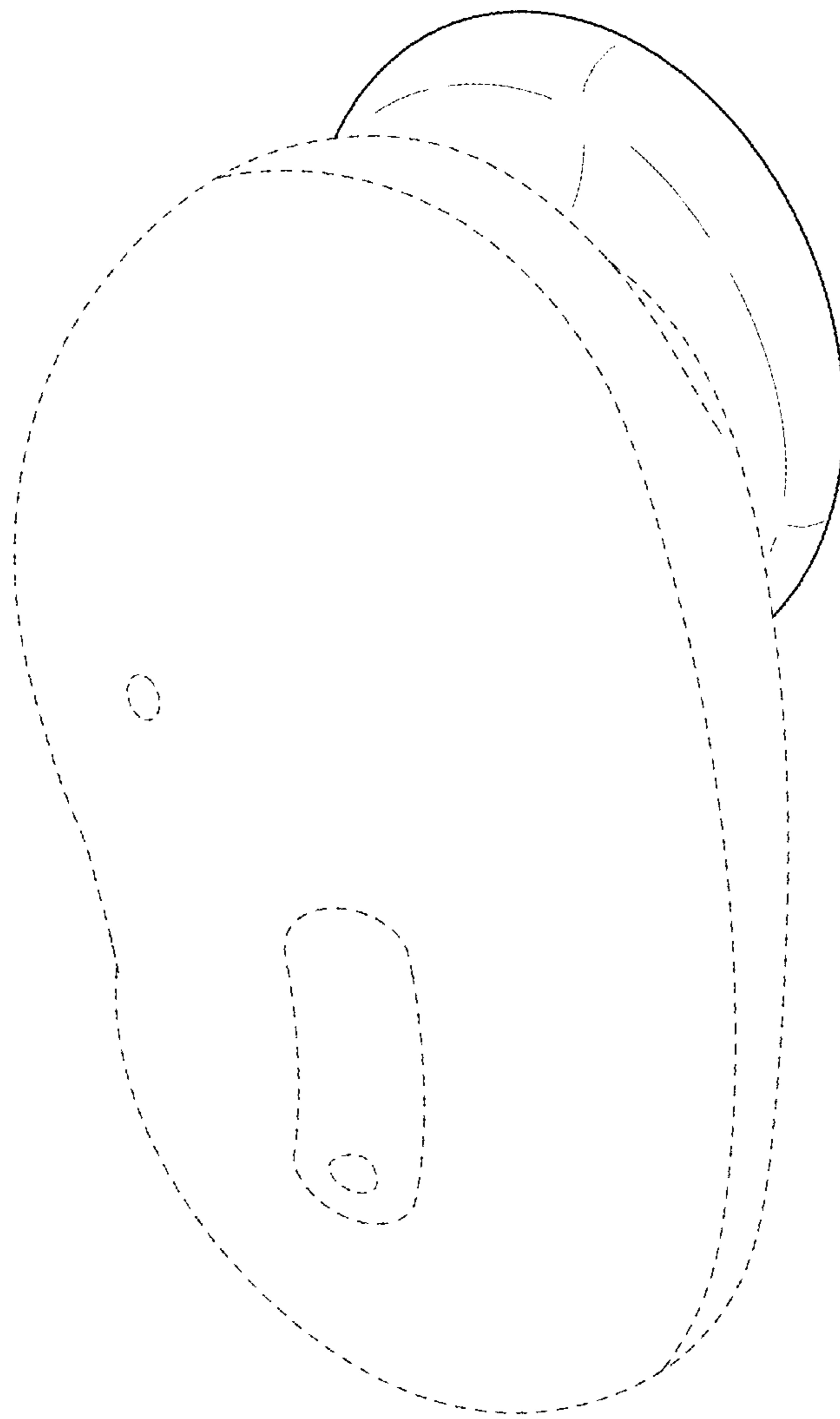

FIG. 2

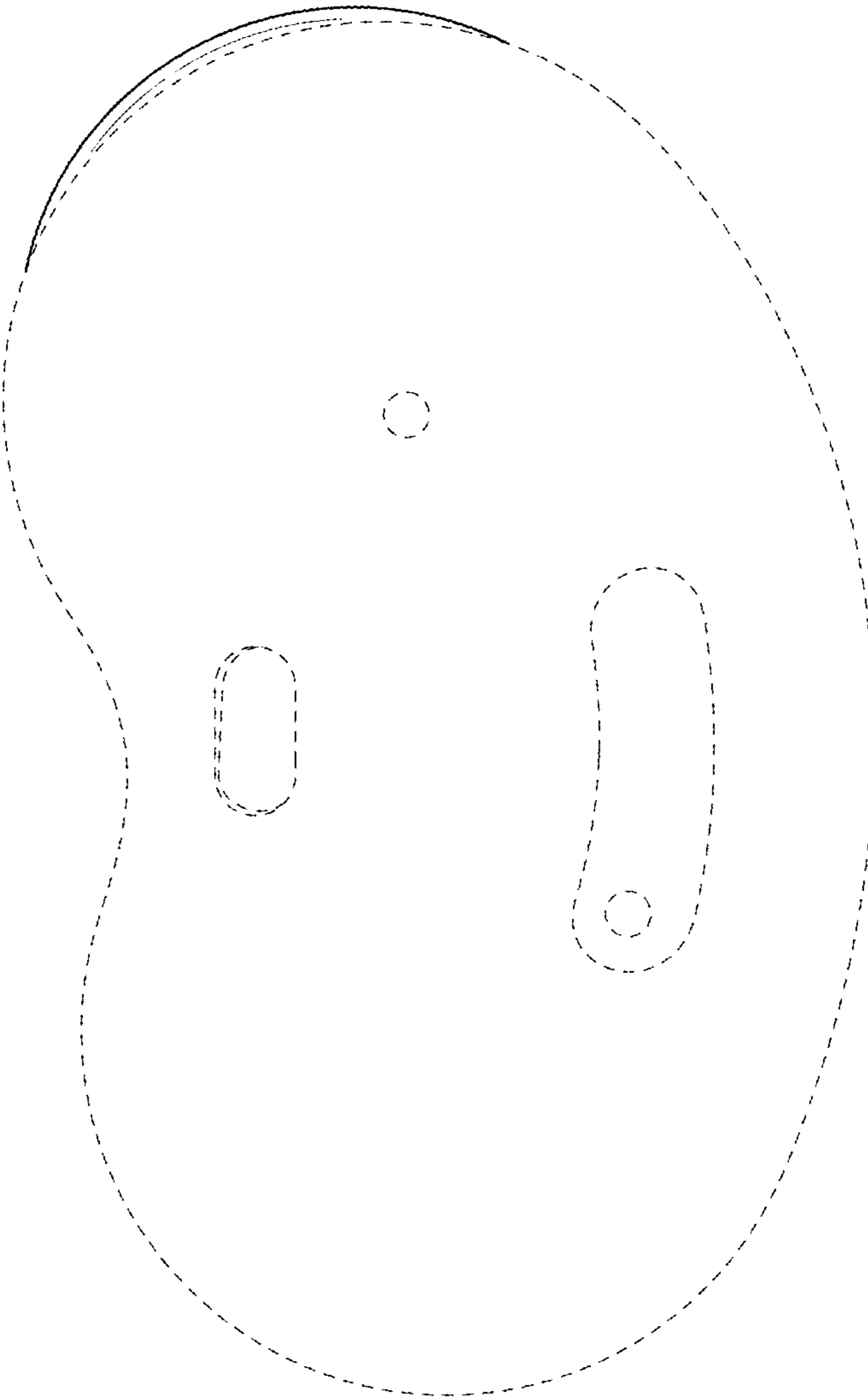

FIG. 3

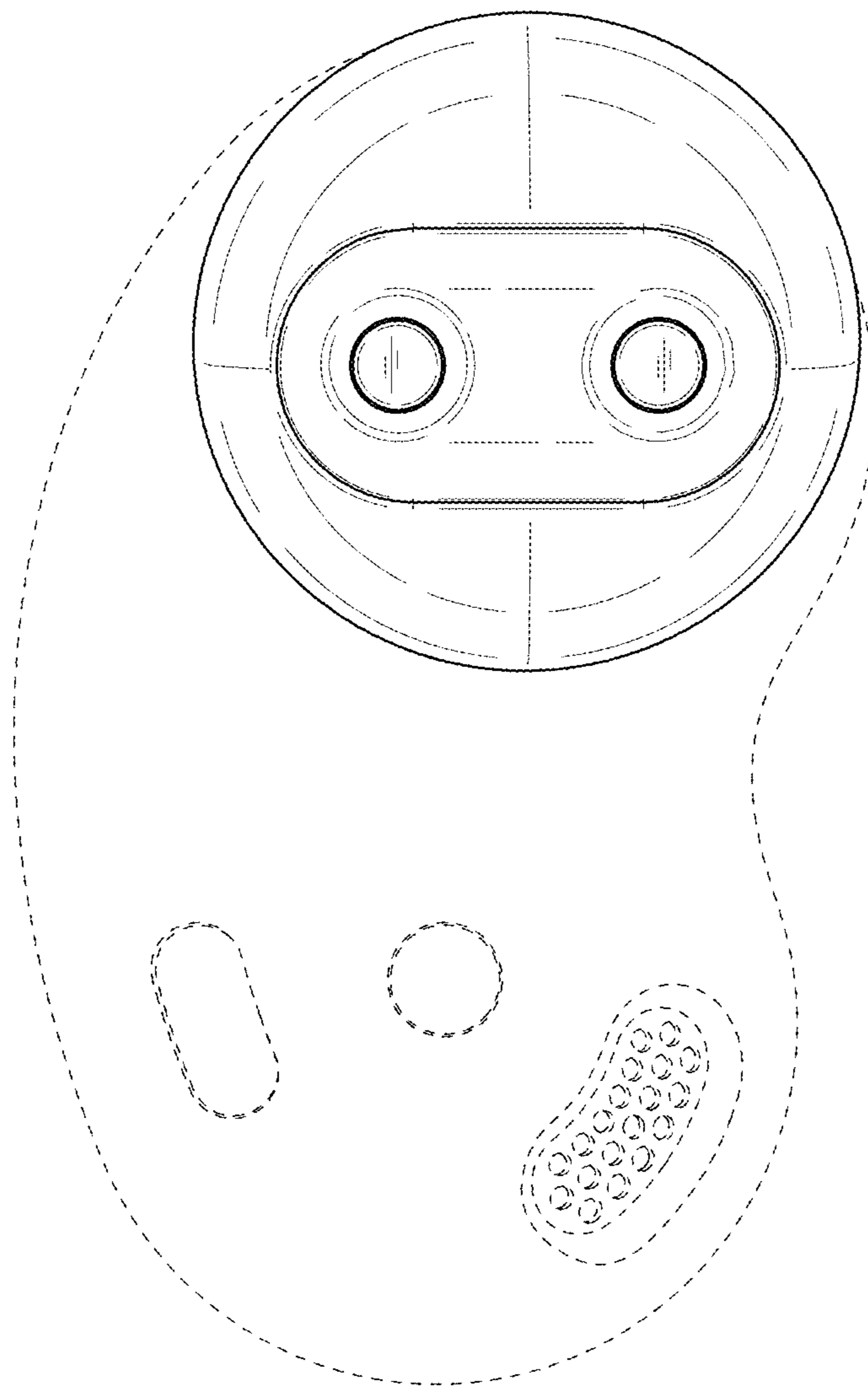

FIG. 4

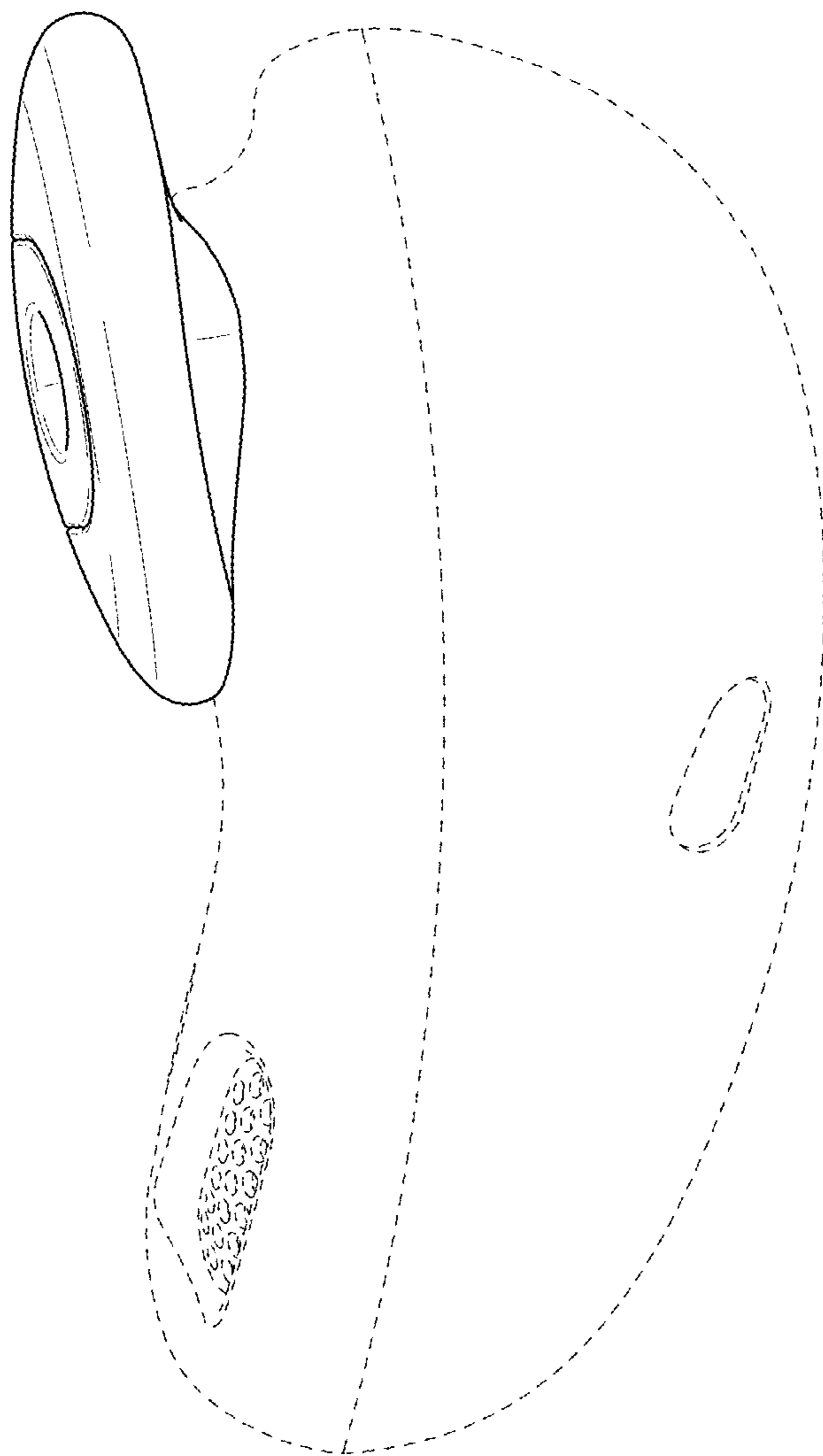

FIG. 5

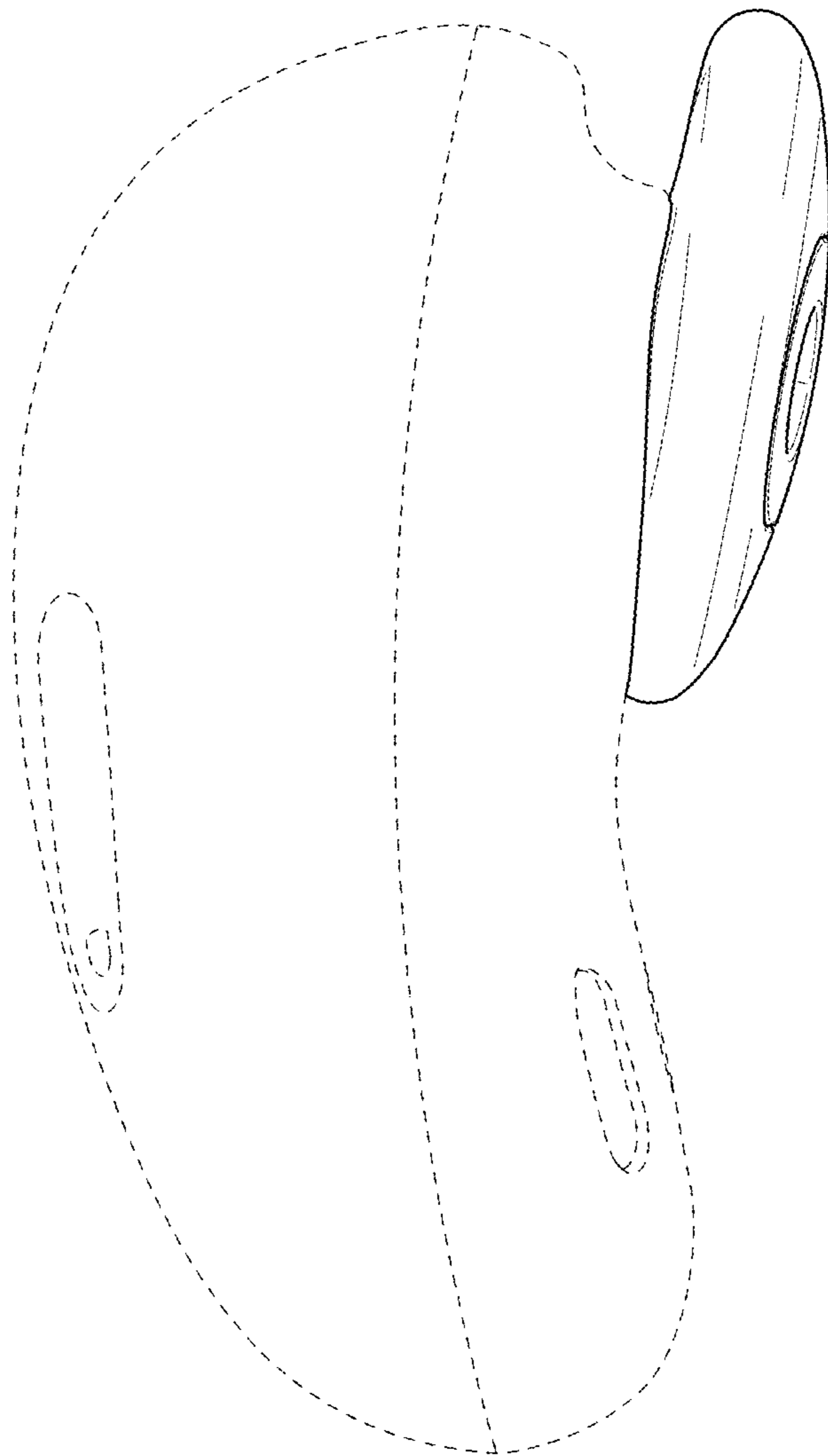

FIG. 6

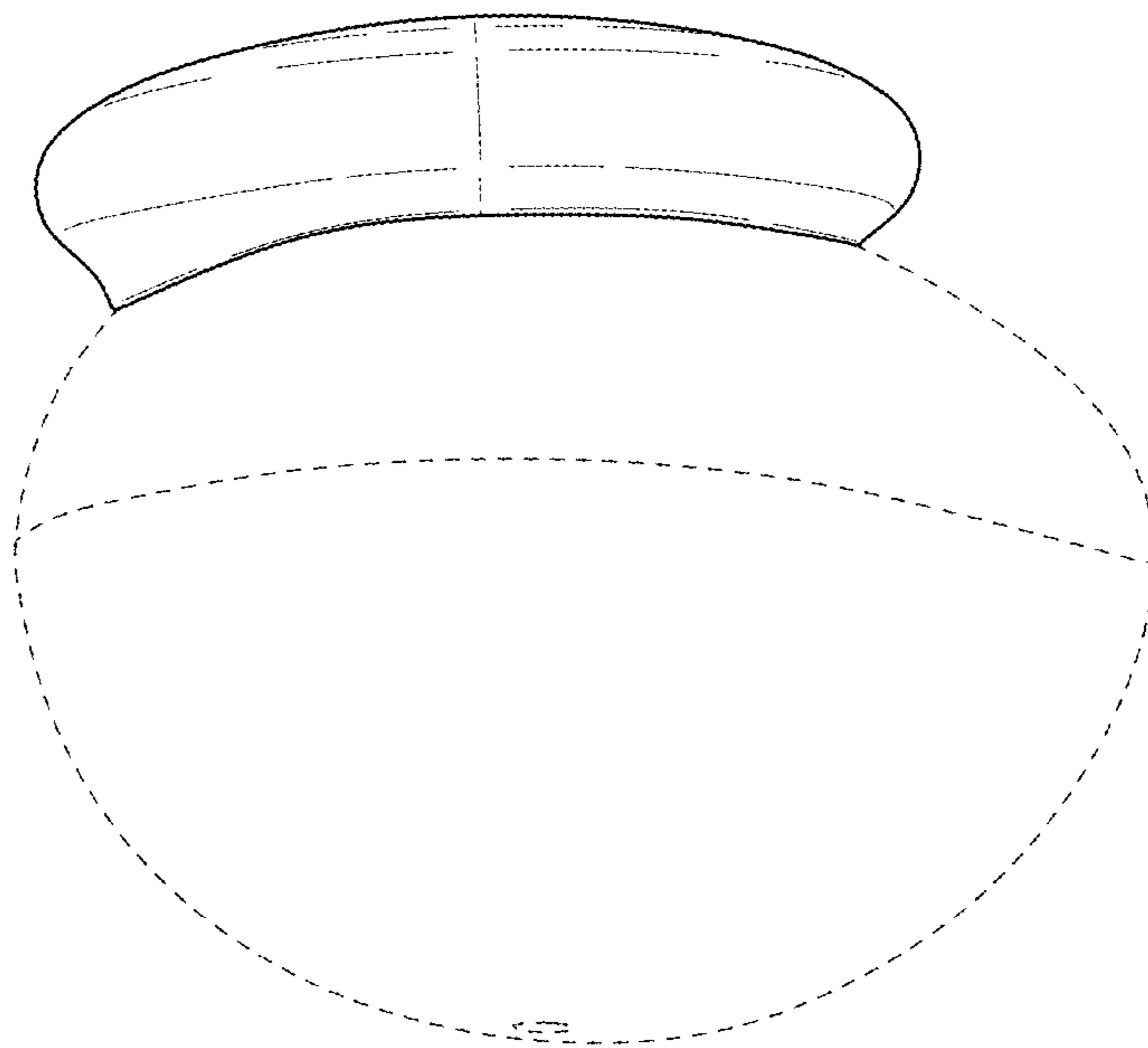



FIG. 7

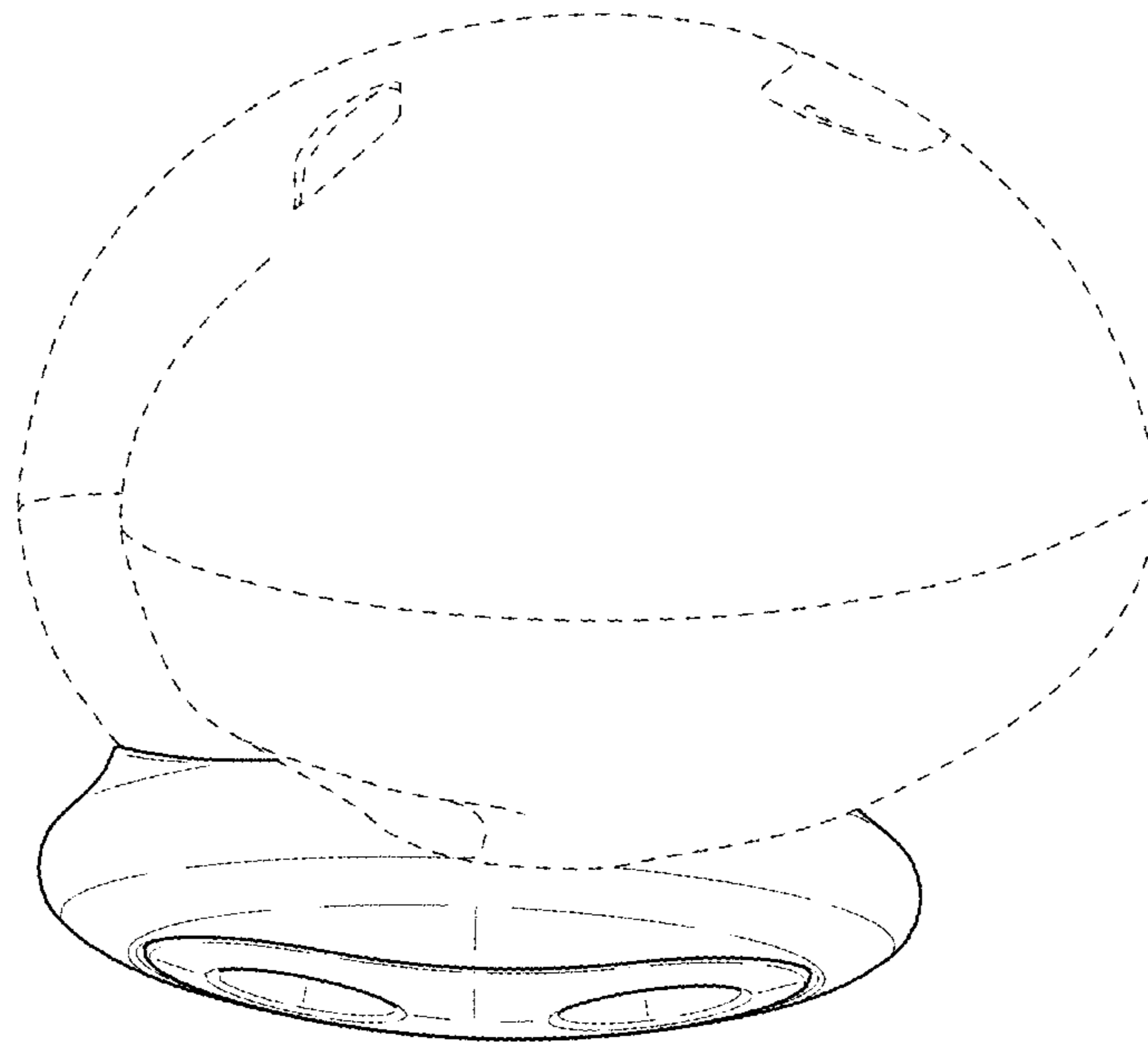

FIG. 8

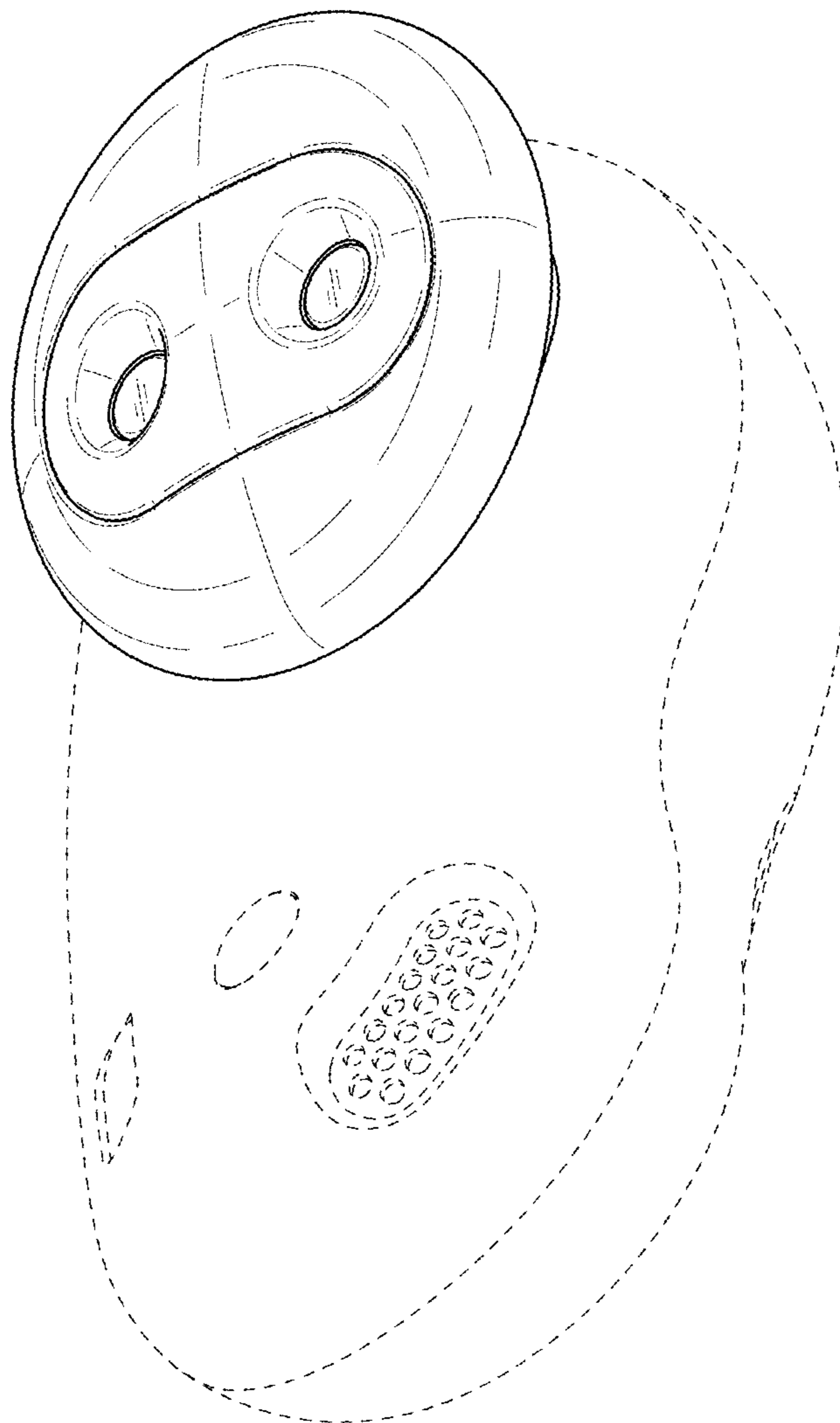

FIG. 9

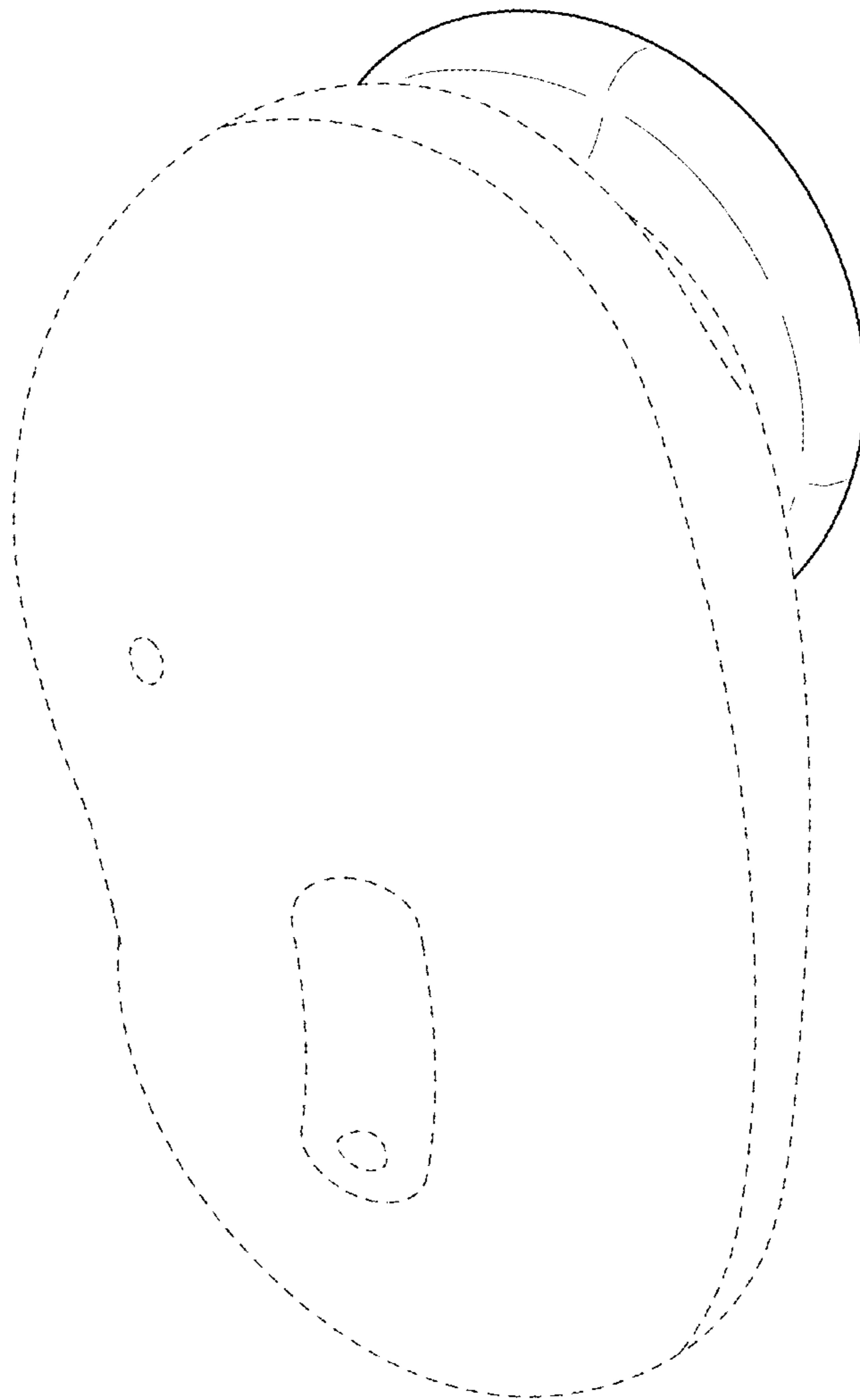

FIG. 10

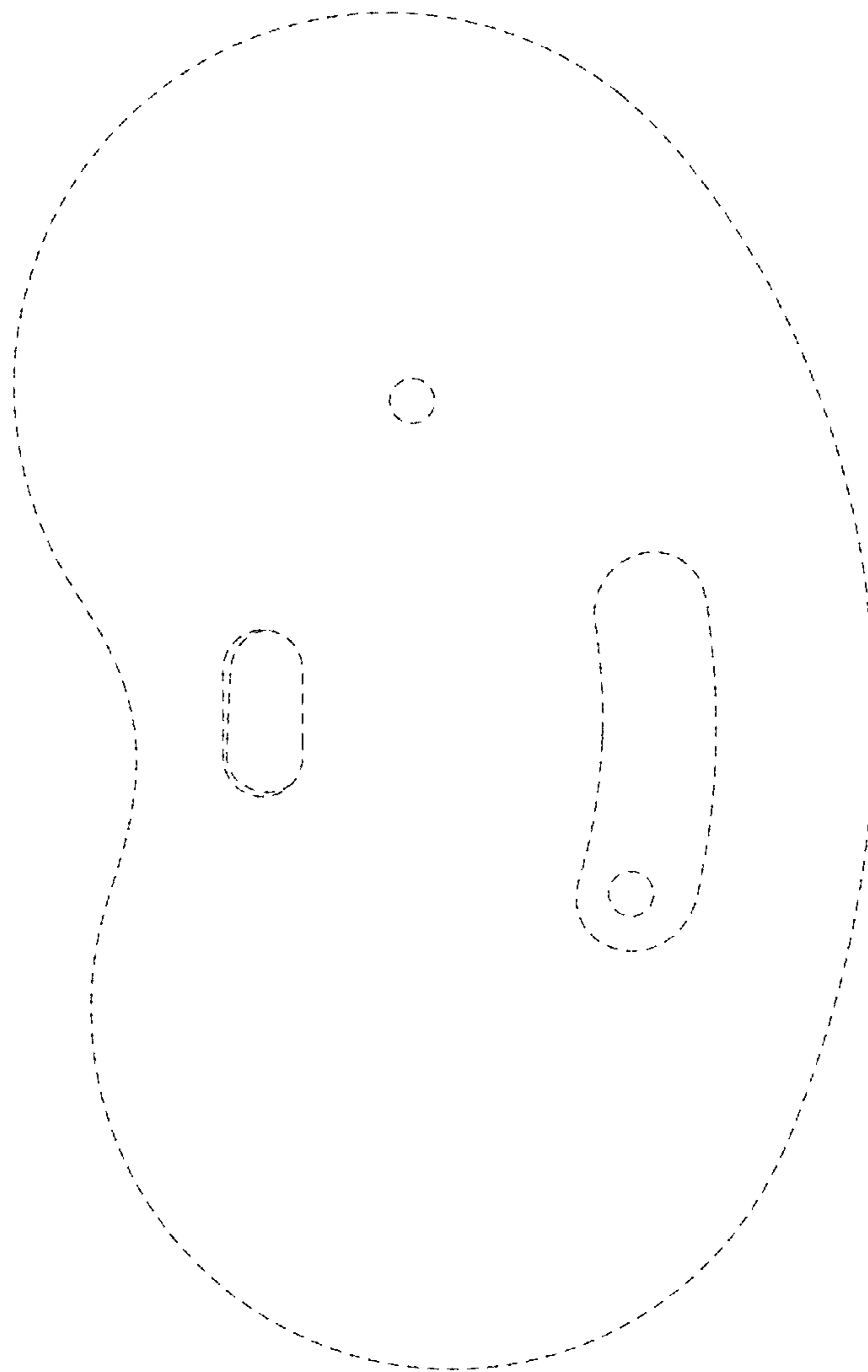

FIG. 11

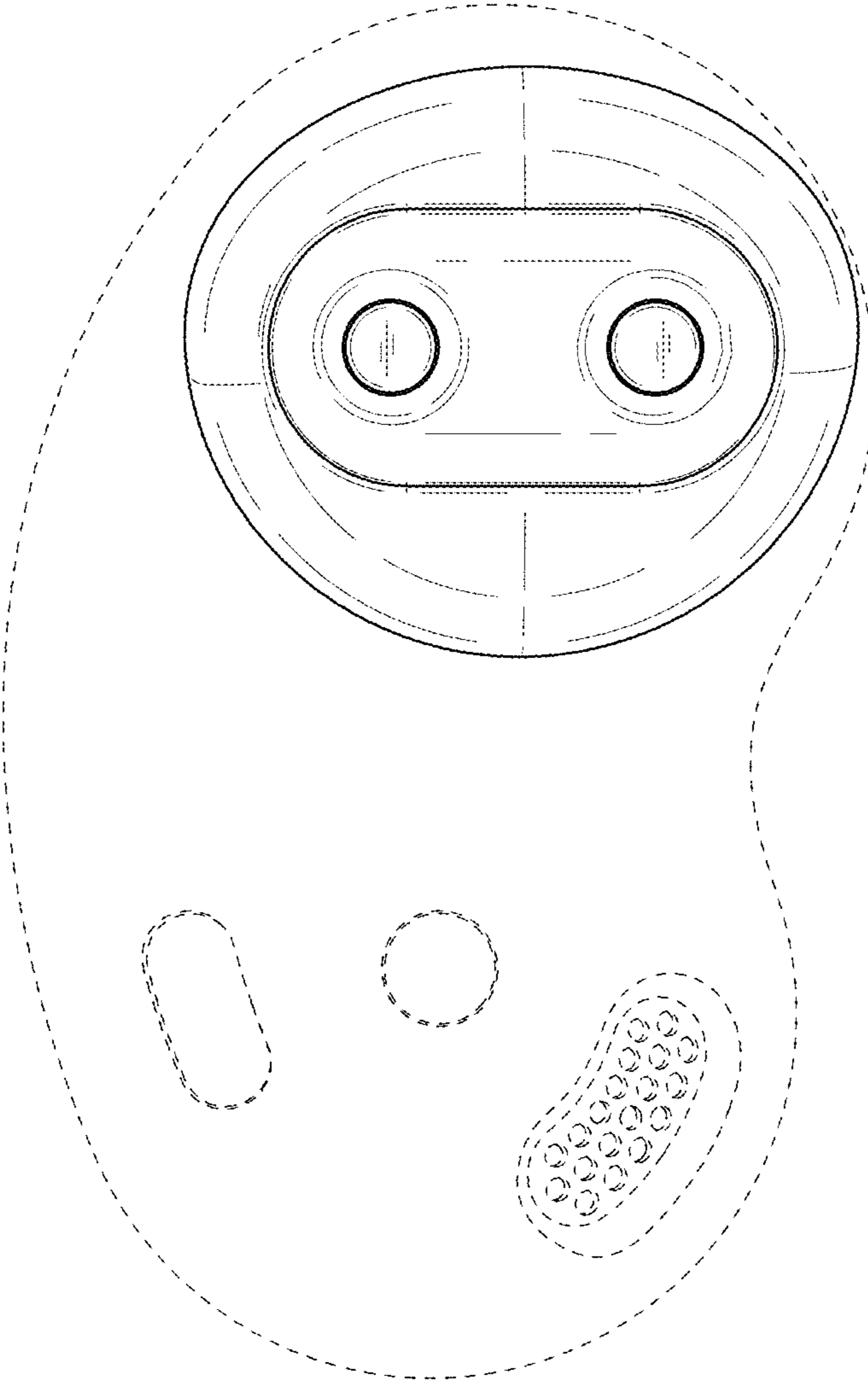

FIG. 12

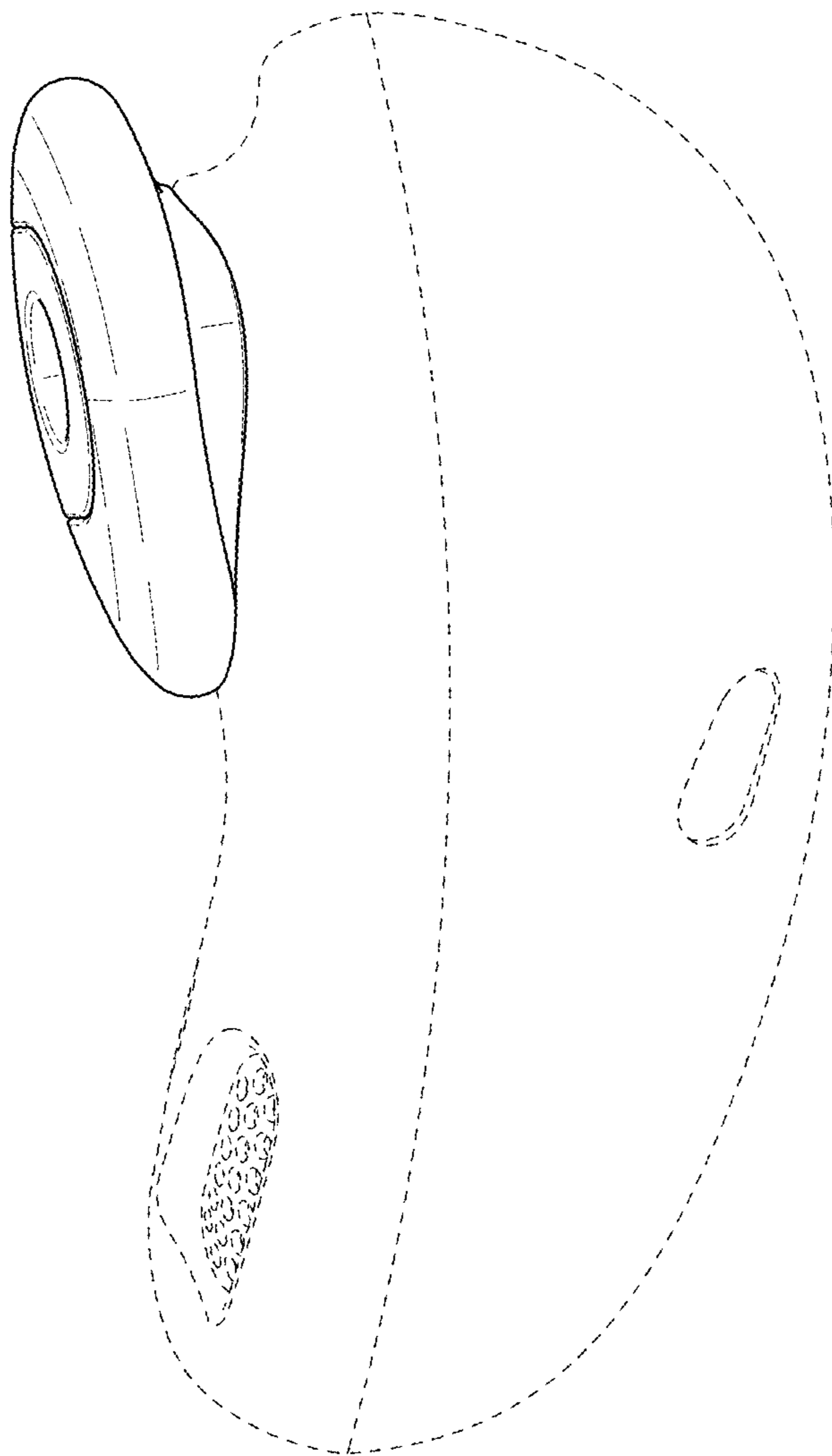

FIG. 13

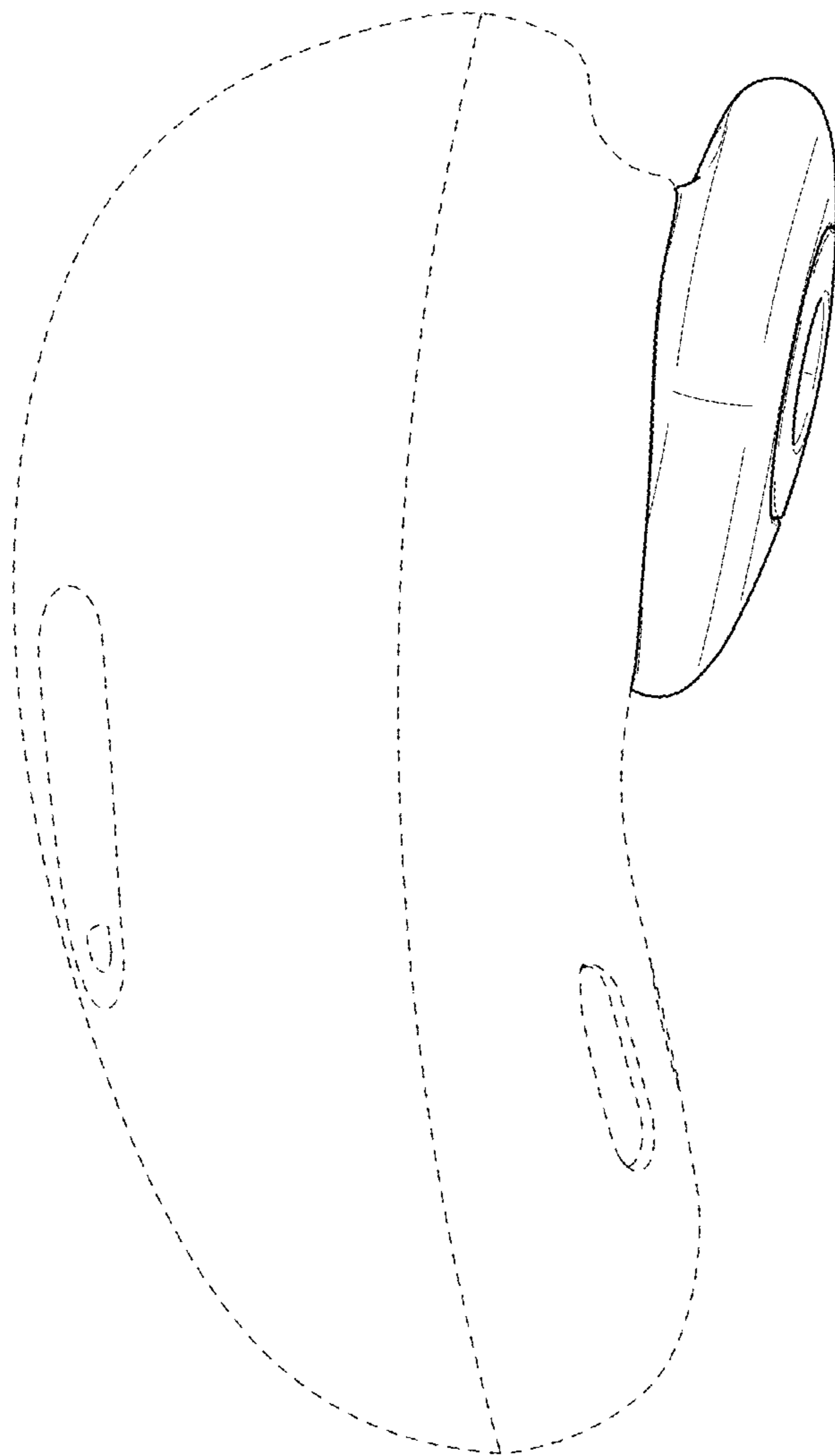

FIG. 14

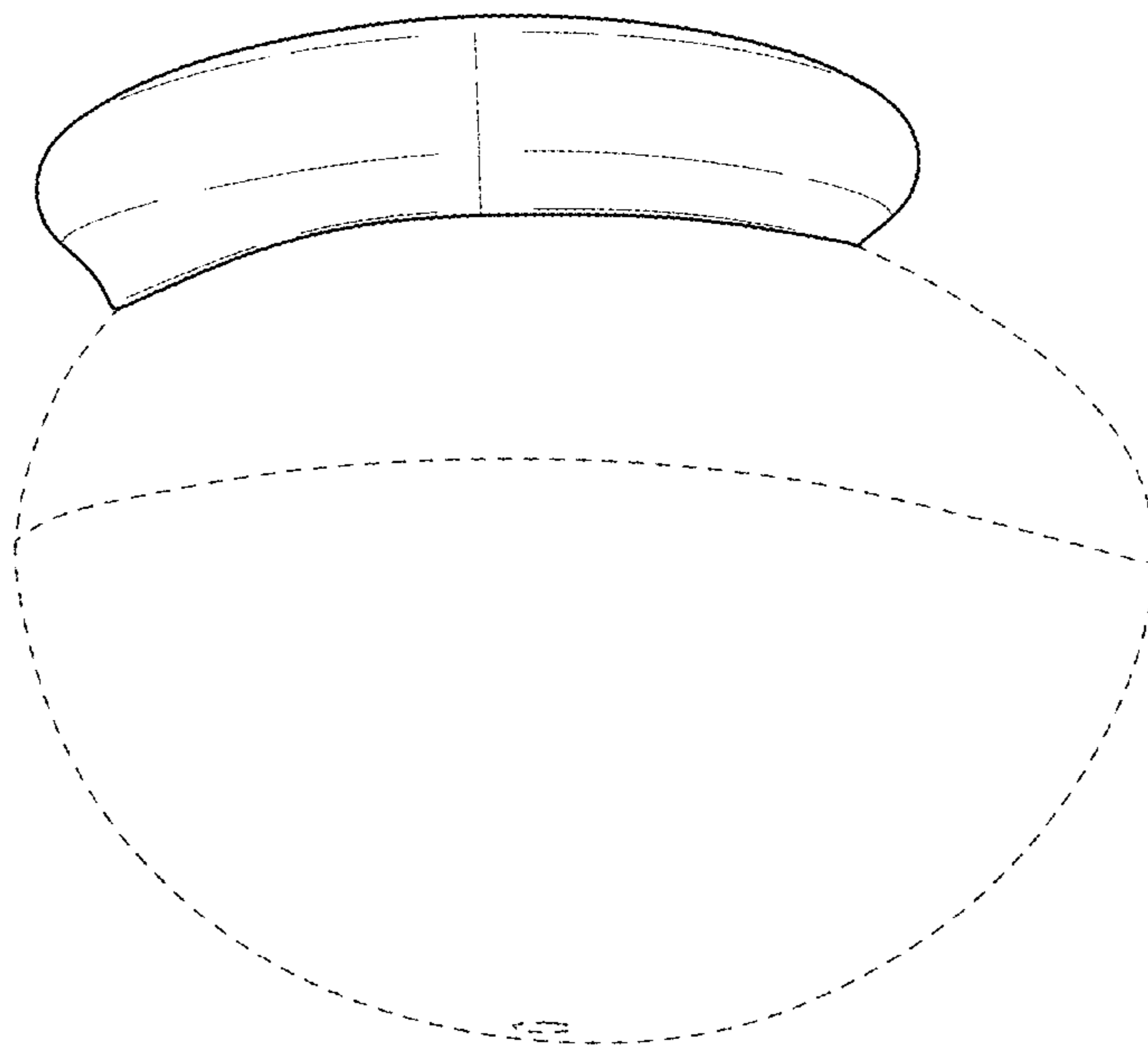



FIG. 15

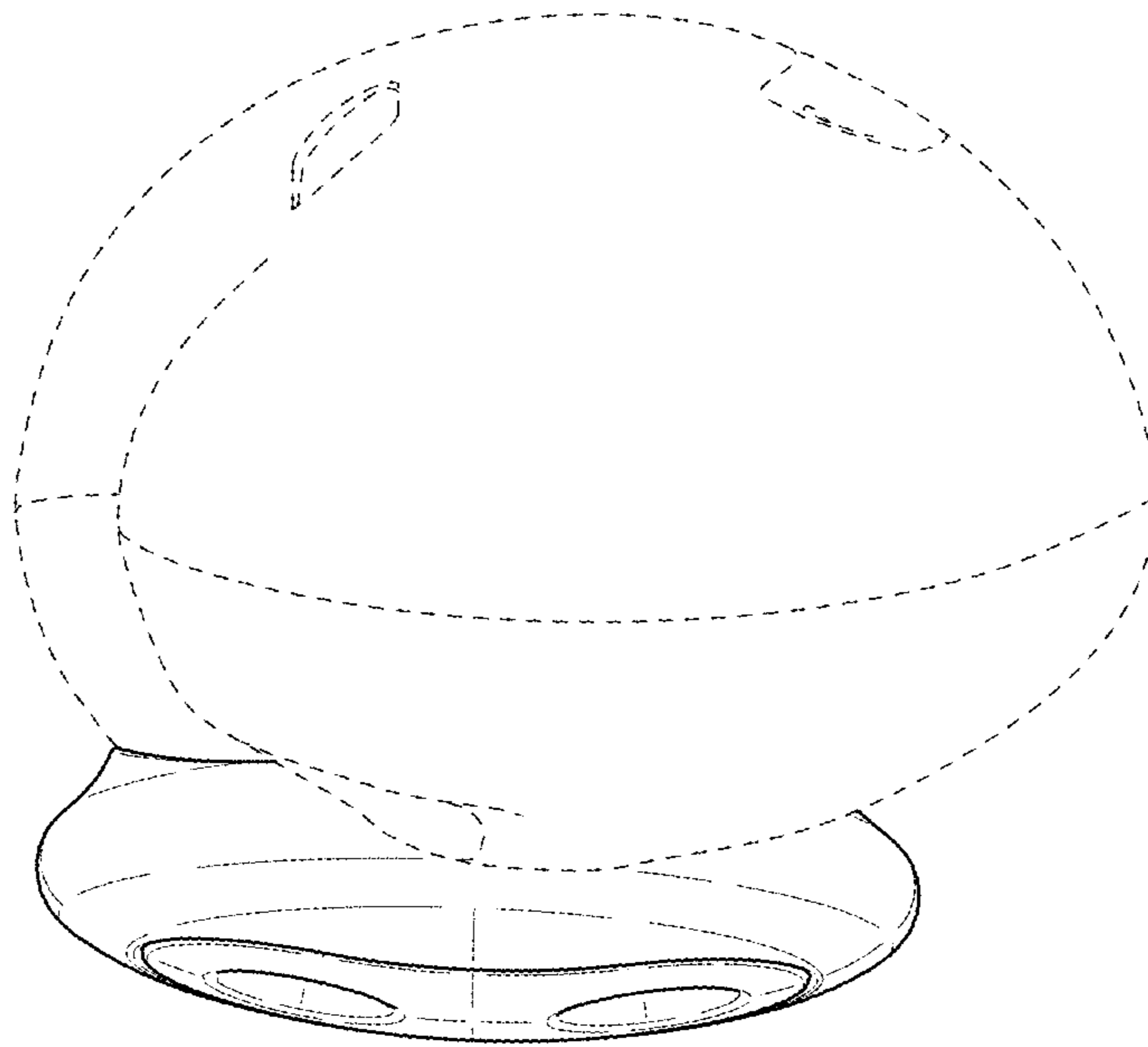

FIG. 16

